

ROBAN

B 407

including

SM2.0 mechanics

Manual



CCPM SCALE RC HELICOPTER

Super Scale 700 Manual – B 407

Release 2.0 – May 2021

Roban Model Limited
No 28, 2nd Industrial Zone, Liuchongwei
Wanjiang City District of Dongguan,
523046 Dongguan County (GD) - PRC

SPECIFICATIONS

Body length:	1680mm
Width:	415mm
Height:	510mm
Main rotor diameter:	1560mm
Main blade length:	700mm
Tail rotor diameter:	280mm
Tail blade length:	105mm
Main shaft diameter:	12mm
Tail shaft diameter:	5mm
Spindle diameter:	8mm
Battery compartment:	120x60x180mm
Motor:*	1x 750MX 450KV brushless outrunner, 12S capable
Speed controller:*	1x 120A brushless, 12S capable
Servo:*	3x metal gear cyclic, 1x metal gear tail servo
Battery:*	44.4V 5000mAh 35C+
Flight time:	5 minutes
Takeoff weight:	8500g
Flight Stabilization:*	3 axis flybarless gyro
Radio Control:*	min. 6 channel with pitch and throttle curves

**) Optionally available equipment*

The Compactor is a high performance radio controlled scale helicopter.

Our goal was to create a simple, high performance helicopter, with a minimum of mechanical components and simple maintenance.

Please read this user manual carefully, it contains instructions for the correct assembly of the model.

Please refer to the web site www.robamodel.com for updates and other important information.

Thank you for your purchase, and have a great time with your Compactor!

Roban Limited

IMPORTANT NOTES

- *This radio controlled helicopter is not a toy.
 - *This radio controlled helicopter can be very dangerous.
 - *This radio controlled helicopter is a technically complex device which has to be built and handled very carefully.
 - *This radio controlled helicopter must be built following these instructions. This manual provides the necessary information to correctly assemble the model. It is necessary to carefully follow all the instructions.
 - *Inexperienced pilots must be monitored by expert pilots.
 - *All operators must wear safety glasses and take appropriate safety precautions.
 - *A radio controlled helicopter must only be used in open spaces without obstacles, and far enough from people to minimize the possibility of accidents or of injury to property or persons.
 - *A radio controlled helicopter can behave in an unexpected manner, causing loss of control of the model, and make it a very dangerous flying object.
 - *Lack of care with assembly or maintenance can result in an unreliable and dangerous model.
- *Neither Roban Limited nor its agents have any control over the assembly, maintenance and use of this product. Therefore, no responsibility can be traced back to the manufacturer. You hereby agree to release Roban Limited from any responsibility or liability arising from the use of this product.

SAFETY GUIDELINES

- *Fly only in areas dedicated to the use of model helicopters.
- *Follow all control procedures for the radio frequency system.
- *It is necessary that you know your radio system well. Check all functions of the transmitter before every flight.
- *The blades of the model rotate at a very high speed; be aware of the danger they pose and the damage they may cause.
- *Never fly in the vicinity of other people.

NOTES FOR ASSEMBLY

Please refer to this manual for assembly instructions for this model.











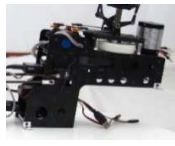







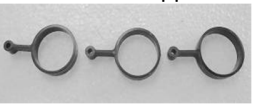







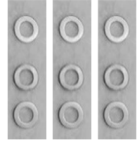
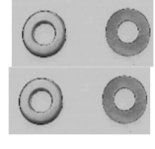



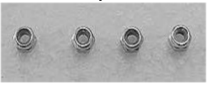

Follow the order of assembly indicated. The instructions are divided into chapters, which are structured in a way that each step is based on the work done in the previous step. Changing the order of assembly may result in additional or unnecessary steps.



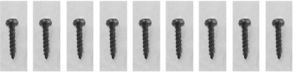



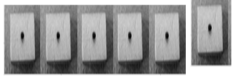
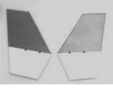









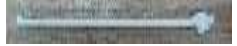













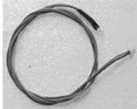

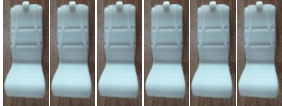

Use thread lockers and retaining compounds as indicated. In general, each bolt or screw that engages with a metal part requires thread lock.

Factory pre-assembled components have been assembled with all the required thread lock and lubricants, and have passed quality control. It is not necessary to disassemble and re-assemble them.

We do not recommend the use of thin cyanoacrylate glue for surface mount of painted parts. The fumes of the curing glue leave white stains on the clear coat, which are hard to remove.

CONTENTS:

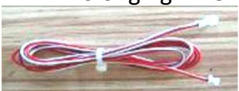
<p>1 – Main Frame</p> 	<p>2 – Tail rotor assy</p> 	<p>3 – Main rotor assy</p> 	<p>4 – – Motor pulley</p> 
<p>5 – Tail boom clamp</p> 	<p>6 – Ball links x2</p> 	<p>7 – Tail servo holder</p> 	<p>8 – Main rotor blades x4</p> 
<p>9 – Tail rotor blades x4</p> 	<p>10 – Pushrod supports x3</p> 	<p>11 – Long tail pushrod</p> 	<p>12 – Long tail boom</p> 
<p>13 – Long torque tube</p> 	<p>14 – Tail boom supports</p> 	<p>15 – Tube Bearings x2</p> 	<p>16 – Tail servo holder x2</p> 
<p>17 – L brackets x4</p> 	<p>18 – Washer M3 x8</p> 	<p>19 – Washer M4 x4</p> 	<p>20 – Screw M3x16 x4</p> 
<p>21 – Screw M4x10 x4</p> 	<p>22 – Screw M3x10 x6</p> 	<p>23 – M3 Nyloc Nut x4</p> 	<p>24 – Nut M2 x4</p> 
<p>25 – Ball links x4</p> 	<p>26 – Panhead screw M3x10 x3</p> 	<p>27 – Motor shaft support</p> 	<p>28 – Support holders x3</p> 
<p>29 – Screw A2x6 x10</p> 	<p>30 – Screw A2x8 x4</p> 	<p>31 – Screw A3x12 x3</p> 	<p>32 – Screw A3x25 x4</p> 
<p>33 – Wooden washers x6</p> 	<p>34 – Horizontal Tail Wings</p> 	<p>35 – Tail fin</p> 	<p>36 – Tail wings</p> 

<p>37 – Front Window</p> 	<p>38 – Plastic Spacers x2</p> 	<p>39 – Antenna x2</p> 	<p>40 – Tail distancer</p> 
<p>41 – Upper Wire Cutter</p> 	<p>42 – Scale Part</p> 	<p>43 – Lower Wire Cutter</p> 	<p>44 – Scale Part</p> 
<p>45 – Scale Part x2</p> 	<p>46 – Upper Wire Cutter</p> 	<p>47 – Gear holder x4</p> 	<p>48 – Footstep</p> 
<p>49 – Landing Gear</p> 	<p>50 – Gear holder x2</p> 	<p>51 – Gear holder x2</p> 	<p>52 – Tail boom damper</p> 
<p>53 – Foot rest</p> 	<p>54 – 12mm white cap</p> 	<p>55 – 12mm red cap</p> 	<p>56 – Green light with socket</p> 
<p>57 – Red light with socket</p> 	<p>58 – Red light</p> 	<p>59 – White light</p> 	<p>60 – Prolonging wire x4</p> 
<p>61 – LED controller</p> 	<p>62 – Instrument panel</p> 	<p>63 – Scale part</p> 	<p>64 – Scale part</p> 
<p>65 – Scale part</p> 	<p>66 – Scale part</p> 	<p>67 – Scale part</p> 	<p>68 – Scale part</p> 
<p>69 – Scale part</p> 	<p>70 – Scale part</p> 	<p>71 – Prolonging wire</p> 	<p>72 – Decal Set</p> 

ADDITIONAL COMPONENTS REQUIRED

- *Electric Motor:
12S – 450KV 750MX, or similar
pinion shaft diameter 6mm
- *Speed controller:
minimum 120A to be safe
- *Batteries: 10-12S 4000-5000mAh
- *1 flybarless 3 axis control unit, suitable for scale flying
- *Radio power system
- *3 cyclic servos
- *1 tail rotor servo
- *6 channel radio control system on 2.4 GHz

TOOLS, LUBRICANTS, ADHESIVES

- *Generic pliers
- *Hexagonal driver, size 1.5, 2, 2.5, 3, 4mm
- *4mm T-Wrench
- *5.5mm Socket wrench (for M3 nuts)
- *8mm Hex fork wrench (for M5 nuts)
- *Medium threadlocker (eg. Loctite 243)
- *Strong retaining compound (eg. Loctite 648)
- *Spray lubricant (eg. Try-Flow Oil)
- *Synthetic grease (eg. Tri-Flow Synthetic Grease)
- *Cyanoacrylate adhesive
- *Pitch Gauge (for set-up)
- *Soldering equipment (for motor wiring)

Inside the main box there are:

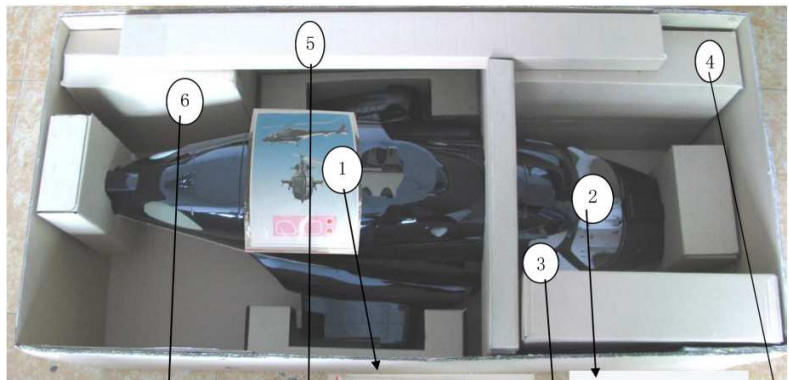

Inside the main box:

- Bag 1: Manual
- Box 2: Fuselage
- Box 3: Tail Wings
- Box 4: Scale parts, Accessories
- Box 5: Boom, Blades, Tail blades, Rods
- Box 6: Mechanics

Assembly Scale Fuselage

Prior to installing the mechanics into the fuselage, please prepare the fuselage according to the following steps. Installation into the fuselage most of the helicopter mechanic become inaccessible. The landing gear has to be installed first. As you will have to turn the

mechanics over, please make sure that you are not scratching the paint by using a old blanket or a rig while working on it.

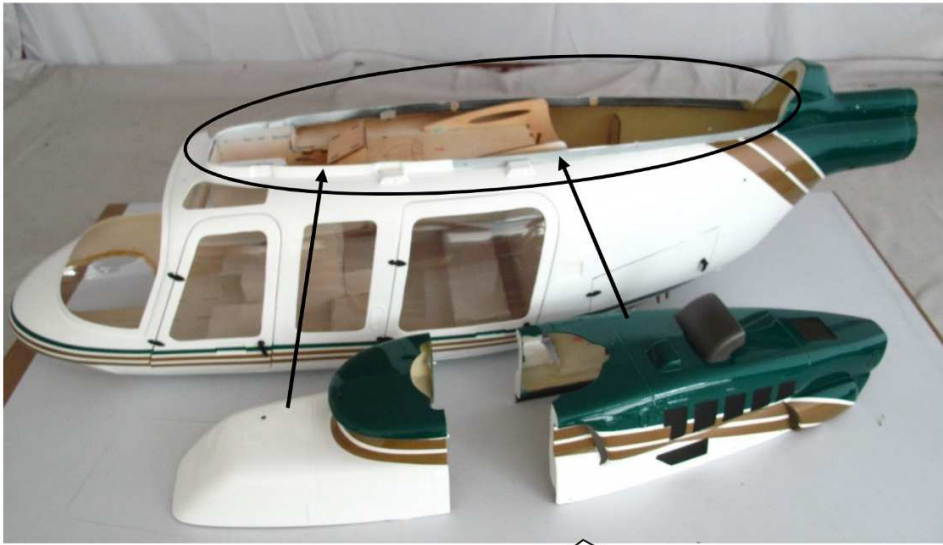

Remove the engine hatch.

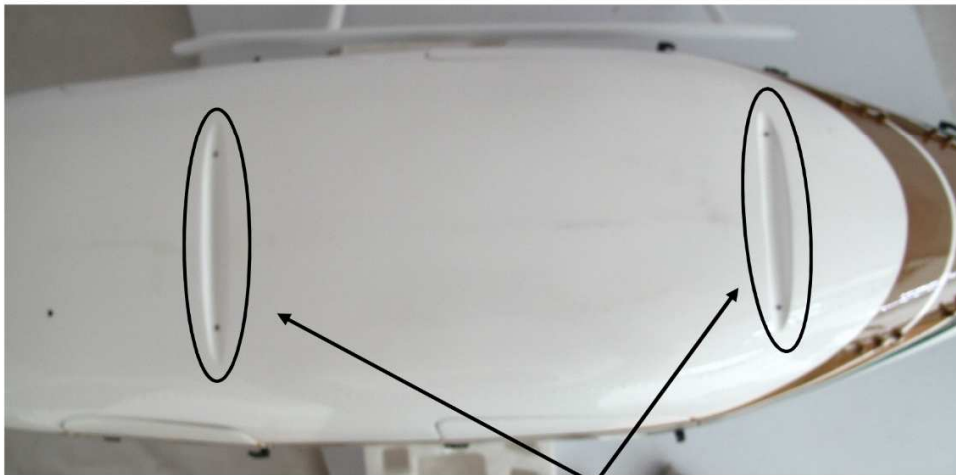

Align the landing gear **【49】** centered on the bottom of the fuselage and drill 4 holes through as shown.



Mount landing gear 【49】 using screws 【32】 .

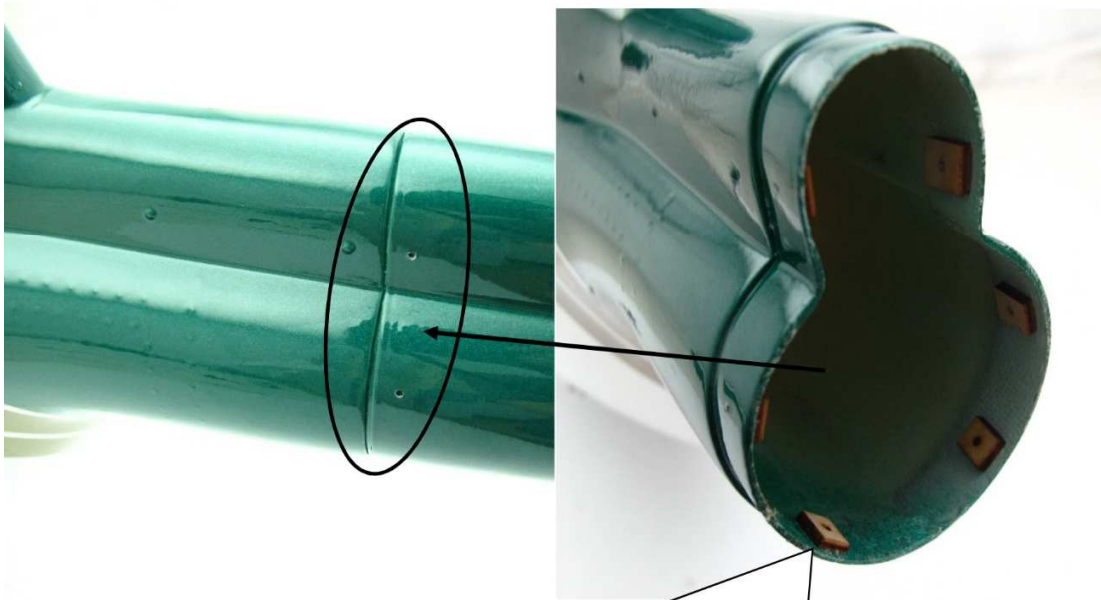

Align the tail boom properly and drill 6 holes through as shown. Glue the wooden washers 【33】 from the inside into the tail boom.

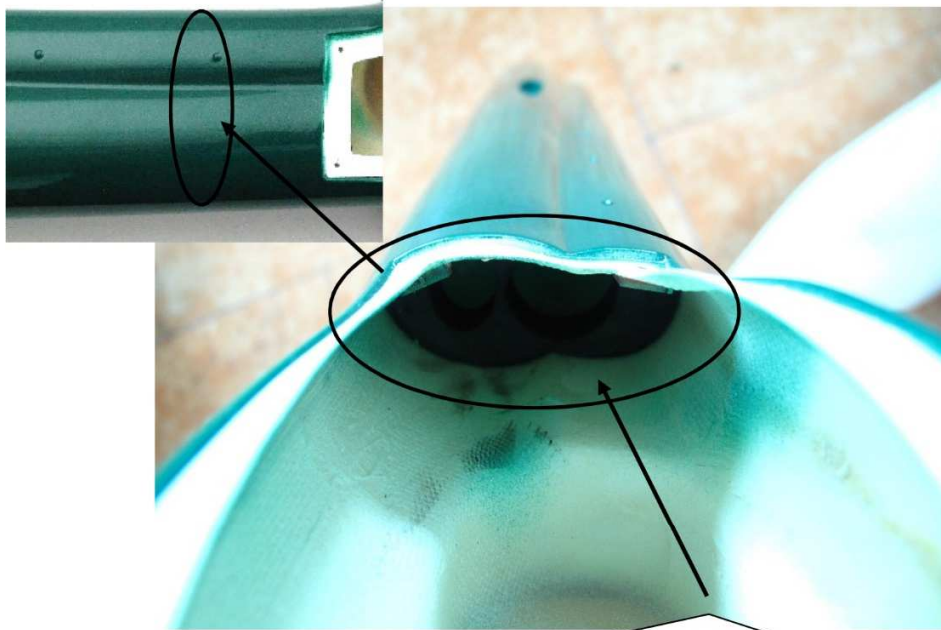

Slide the EVA dampener **【52】** through the tail rotor hatch into the tail boom, move it into the shown position.

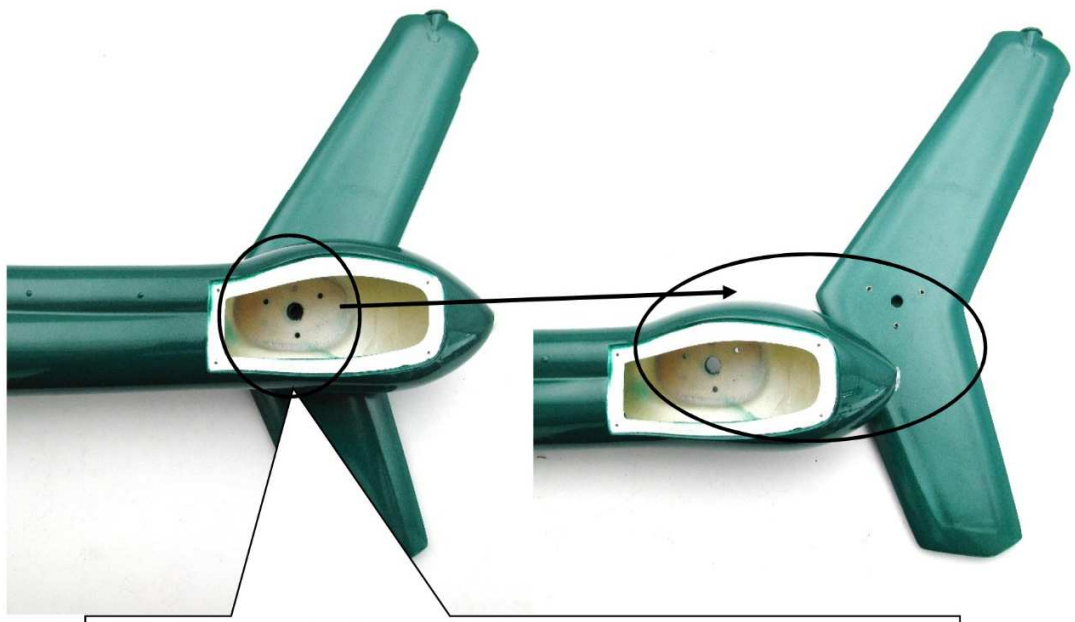

Align the tail fin **【35】** center hole, and adjust the angle, then drill three holes for mounting the fin through.

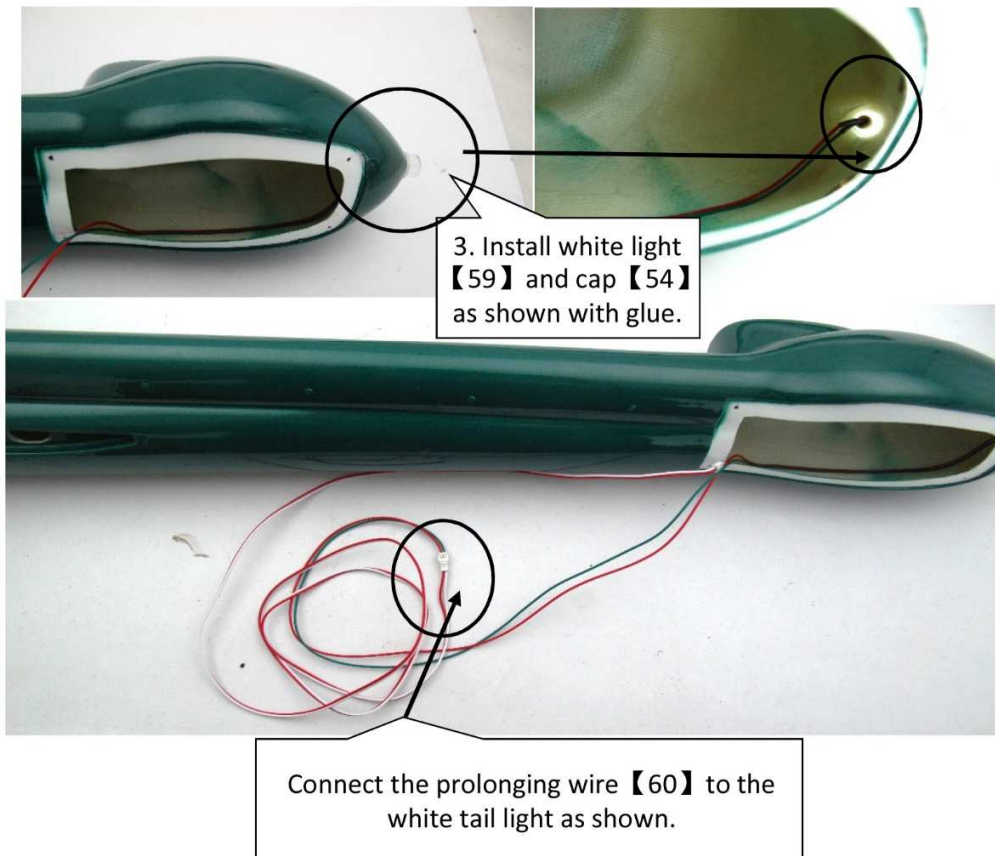
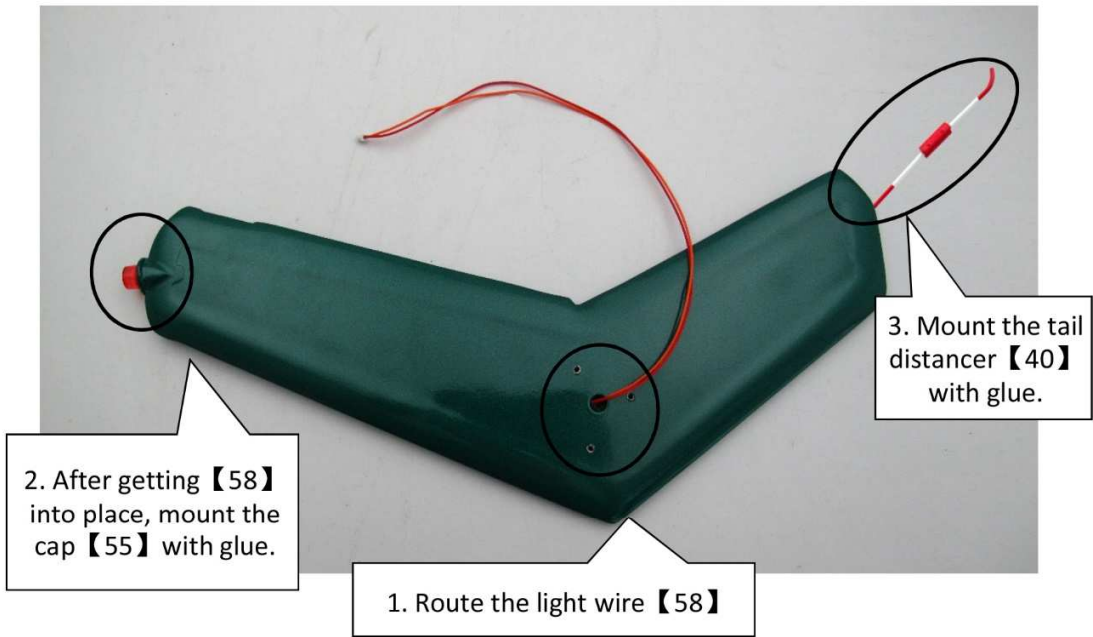

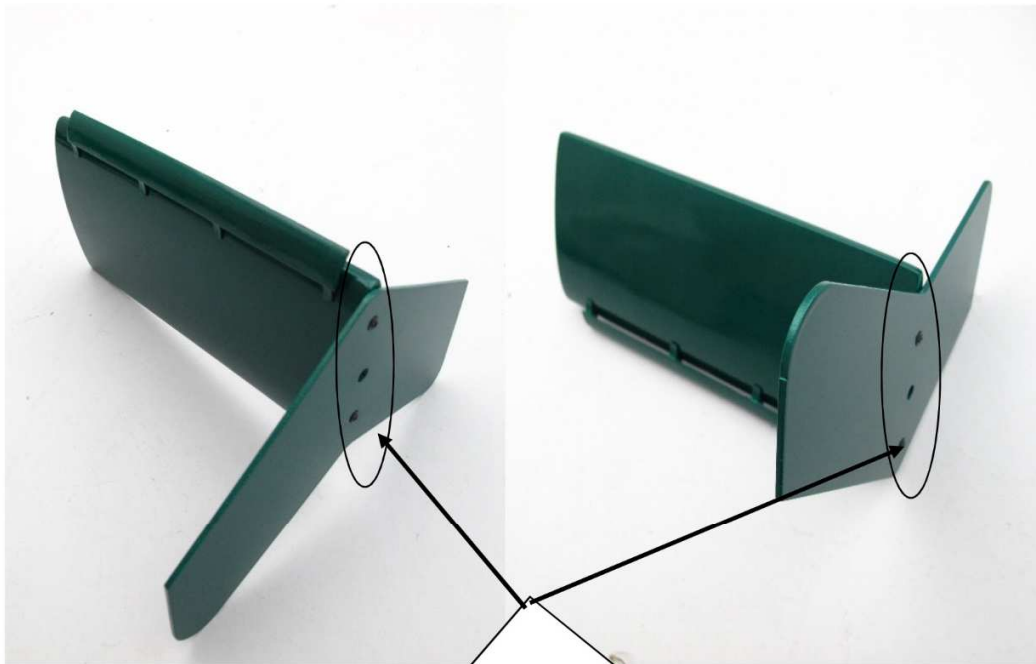

Install the small fins 【34】 onto the horizontal wings 【36】 using screws 【30】 as shown. (You might need to widen the light hole a bit for the next step.)

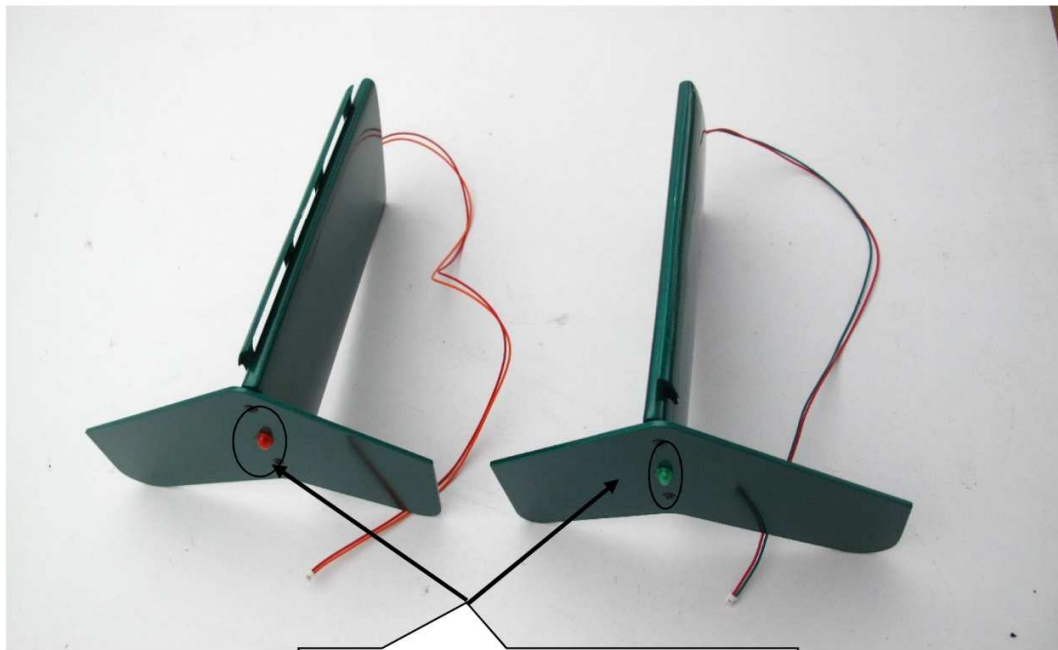

Install the lights 【56】 and 【57】 as shown with glue.

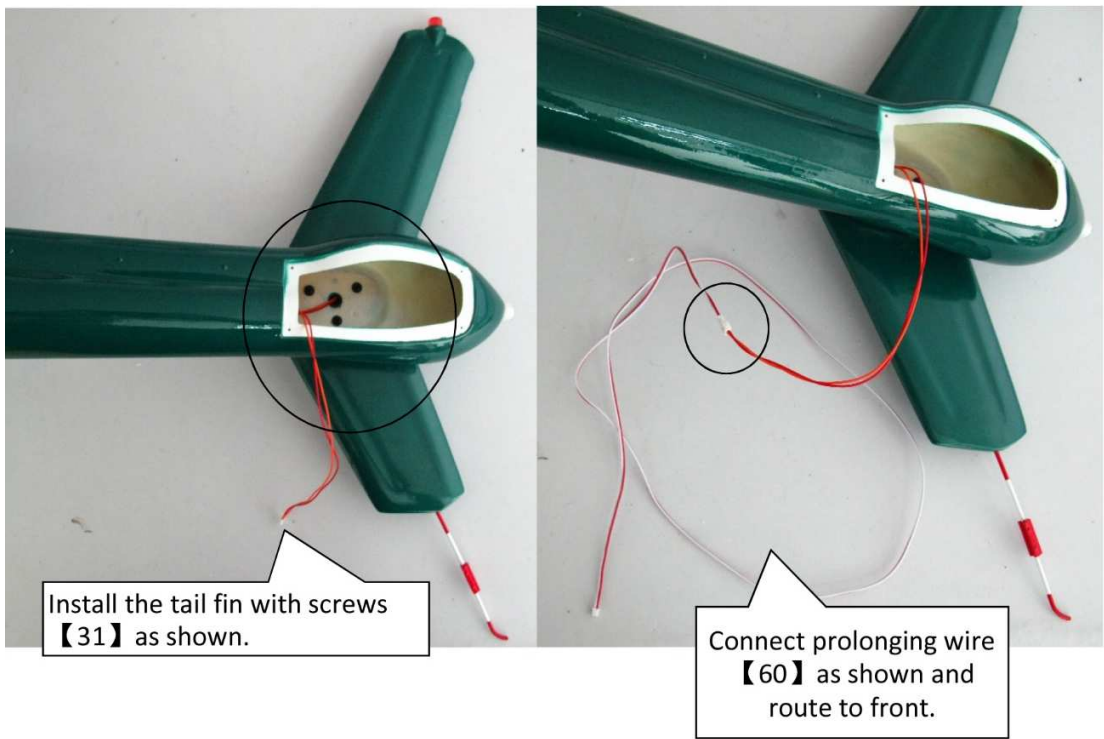
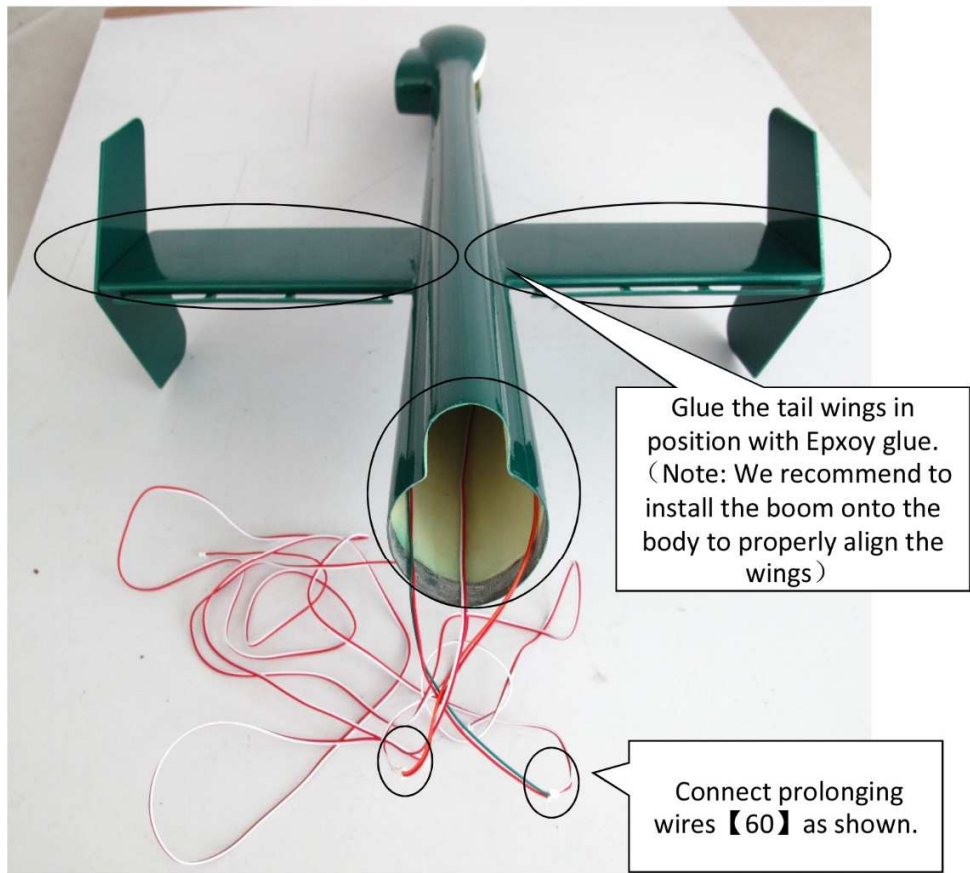

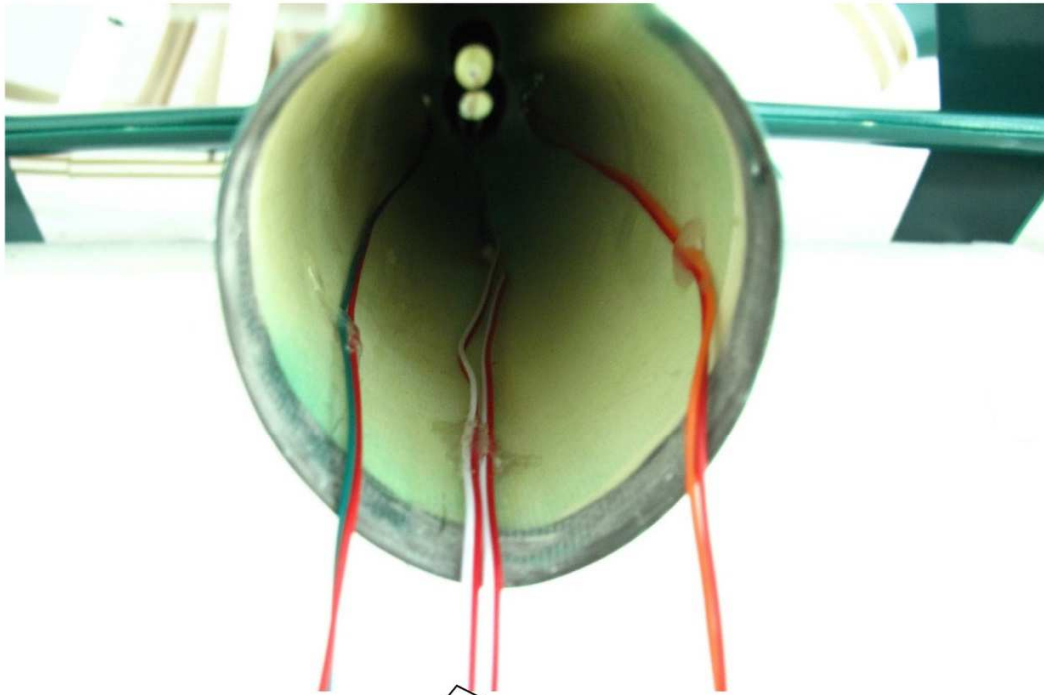

Secure the wires inside the boom with small amounts of glue, this will prevent them from falling around inside the tail boom.

Assembly Mechanics

The mechanics are almost entirely preassembled and split up into four sections: rotorhead, main frame, tail frame and tail tube. Prior to the installation into the scale fuselage, the mechanics have to be entirely assembled, electronic components installed, adjusted and tested. After installation into the fuselage most of the helicopter mechanic become inaccessible.

Step 1 – Rotorhead

Slide the rotorhead onto the main shaft. Use screw (70-00006) and nylon nut (70-00007) to secure the rotorhead onto the main shaft. Use two screws (70-00008) to additionally clamp up the rotor hub onto the shaft as shown.

Make sure the distance between the ball link and the L lever is equally at 24mm. Finally snap on the ball links (70-00025) on the swashplate's upper disc uni-links (70-00030).

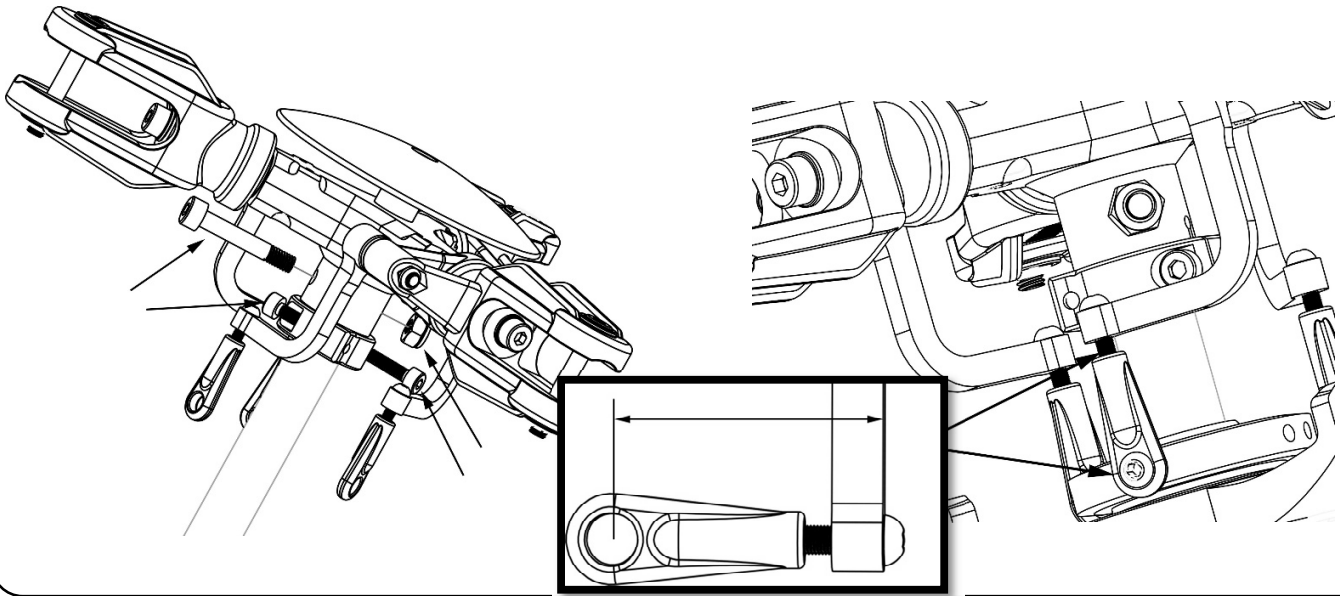

Step 2 – Tail boom

First of all install the center bearings (70-00100) with the holders (02-02006) into the tail boom (70-00095). Distribute the bearings evenly in the tail boom. It is recommended to apply a bit of lubricant onto the tubes inner surface, otherwise the bearing is likely to get stuck before the correct position is reached. Then install the center support ring (600UH1-007), the servo rod guides (70-00040) and the servo two tail servo holders (70-00098). Install the tail torque tube (70-00096) into the tail tube.

Then insert the tail boom into the tail boom holders (70-00093, 70-00094). Lock the tube in place with screw M3x8 (70-00086) via the clamp up and additionally with screw M3x6 (70-00053) as shown. Install the carbon support beams (70-00104-70-00106) on the main frame and the tail boom tail boom clamp (600UH1-007).

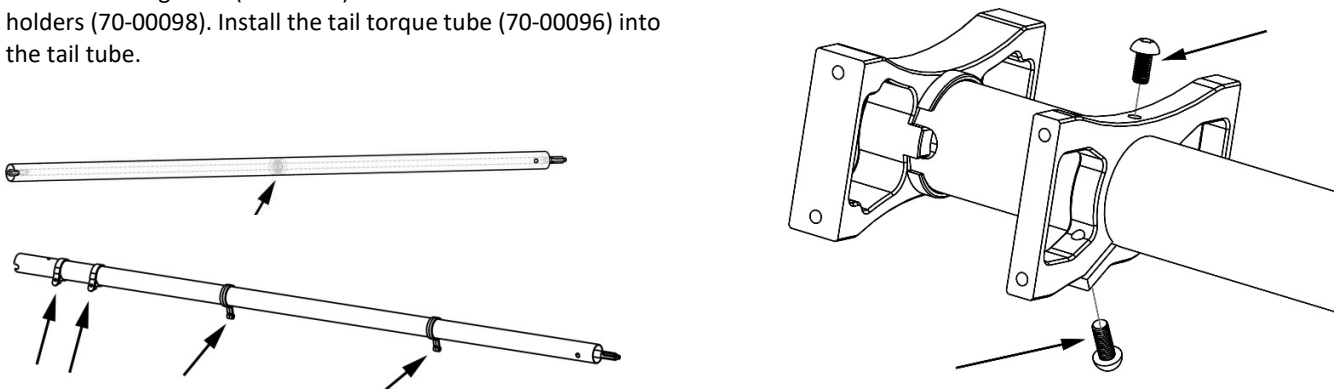

Step 3 – Tail Servo Installation

First of all, mount the holder frame (70-00097) onto the boom holders (70-00098) using screw M3x8. Then mount the tail servo of your choice into the tail frame using screws M3x10, washers and nylon nuts as shown. Install the servo horn and the supplied uniball. Then slide the tail rotor control rod (70-00103) into the four guides. Install the ball link (70-) on both

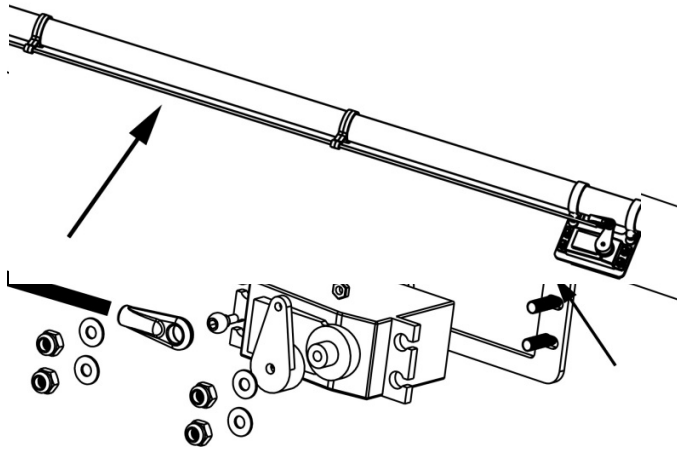

ends of the tail rotor control rod. Distribute the guides evenly along the tail boom. Then install the tail rotor frame onto the tail boom. Lock it with the three screws as shown, but do not use thread lock yet, as it has got to be uninstalled again. Snap the servo control rod onto the ball link.

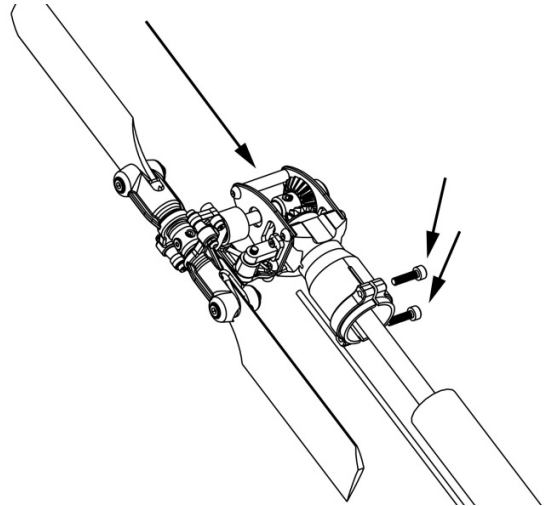

Step 4 – Cyclic Servo Installation

Install the three cyclic servos onto the servo tray as shown. Depending on your servos, you may have to use washers to adjust the servo to the proper installation height. It is strongly recommended to use metal servo horns and only metal geared servos. The multi blade rotor head can feedback forces that may lead to failure of plastic components.

After the servos are installed, you will have to adjust the linkage rods length's according to the schematics below. The distances are uniball center to uniball center:

1=96mm 2=96mm 3=96mm

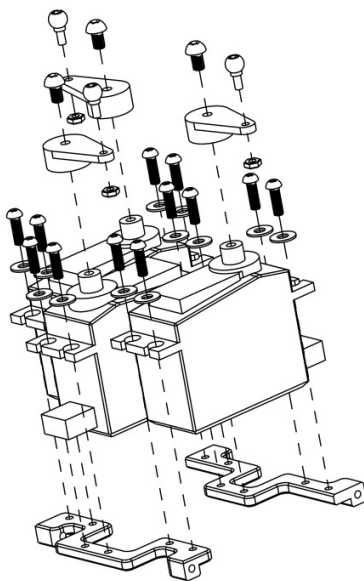

1 = 96mm
2 = 96mm
3 = 96mm

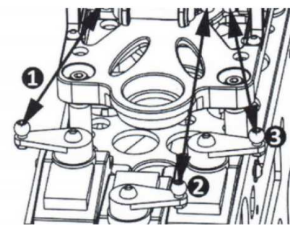

The horn spindle to ball link distance has to be at least 13mm!
min. 13mm

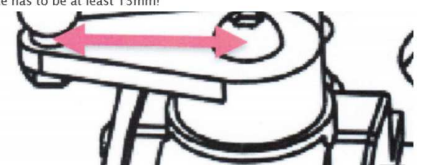

Step 5 – Adjust swashplate linkages

The linkages from the L-Levers to the swash plate have to be set at correct length. Distances are uniball center to uniball center: **1=35mm**

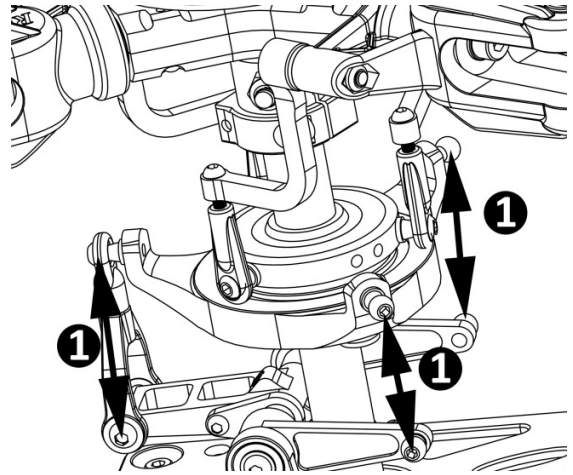

Step 6 – Motor and Belt installation

In order to install the motor, you must first disassemble one of the side frames in order to have access to the mounting screws and access to the belt drive. Hence one side frames fasteners are not tightened upon delivery. Before installing the pinion pulley on the motor, you have to add a flat to the motor shaft in order to secure the pulley with the set screws (70-).

Mount the motor as shown using washers and screws onto the motor mount (70-00066). Make sure to have the motor wire outlet facing into the right direction for connecting them to the ESC. Then insert the belt pulley into the belt and slide it onto the motor shaft. Before you tighten the set screws, make sure that the pinion is installed leveled with the belt pulley, the distance (Fig. 1) is at **24.5mm**.

Use both tensioning screws to tension the belt drive. The belt mustn't be tensioned too tight to avoid unnecessary wear. After installation of the motor, reassemble the side frames.

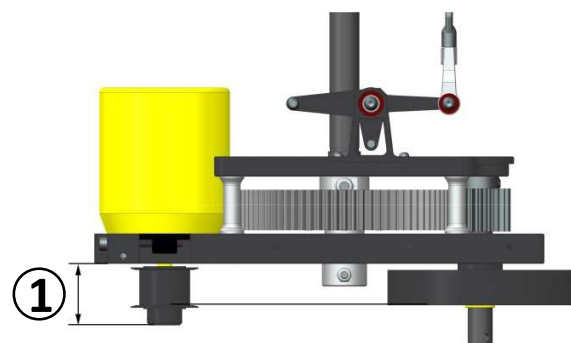
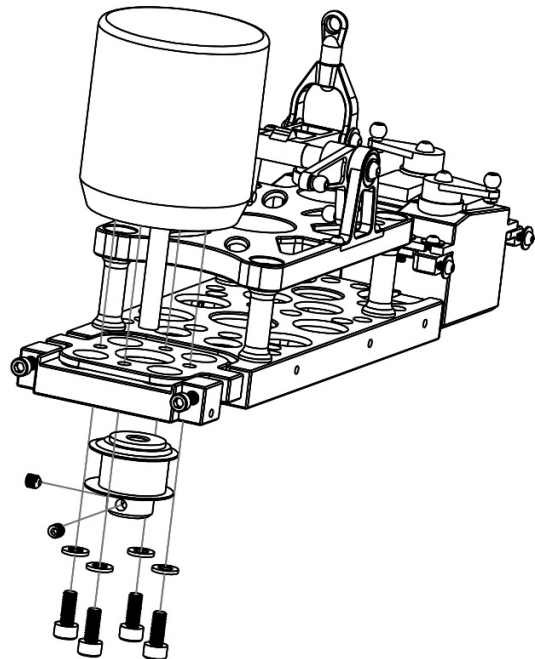
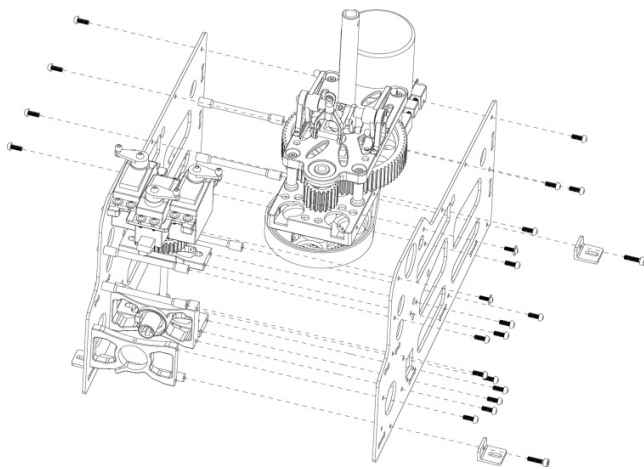

Secondary Motor Support

Certain motors with 25mm mounts and long output shafts can be outfitted with a secondary motor shaft bearing.

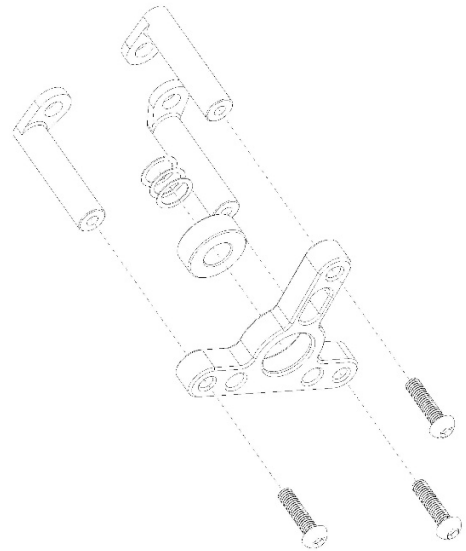
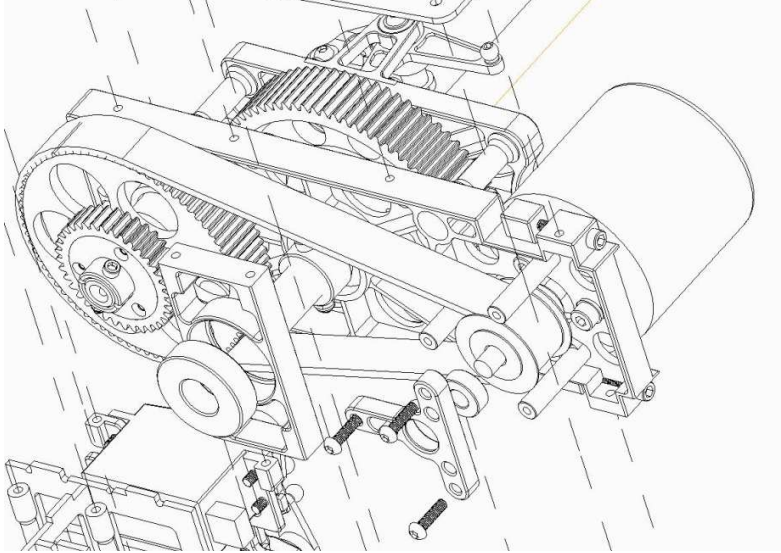

Step 7 – Electrical Wiring and Setup

The mechanics have to be fully electrically setup and adjusted prior to installation into the fuselage. As the use of a 12S (44.4V) setup is necessary, we strongly recommend to run the control equipment on a separate 2S Lipo battery and BEC for security reasons.

In scale configurations main battery power wires may be longer than on comparable 3D helicopter equipment. As HV ESCs do not necessarily have the main battery ground wire connected to the servo signal ground wire, it may be necessary to create an additional connection between the BEC 2S batteries ground wire and the 12S main battery ground wire. Certain configurations without this ground interconnection have led to a loss of signal at the ESC from the receiver due to EMC effects.

The swash plate is a regular 120deg CCPM type, please take your time to adjust all servo travels, center positions – the entire 3 axis gyro – servo – radio setup prior to the installation into the fuselage.

A 530KV motor such as the Align 750MX run at app. 90% throttle (hover) shows satisfying results. As space is limited, please make sure you check the dimensions if you intend to use other brand motors.

In regards to the gyro setup, we recommend to start with standard values of the 3 axis gyro. Make sure you install the gyro in a way that provides easy access for connecting your programming equipment. As the scale fuselage adds additional inertia to each axis, gyros are normally to be set at a lower gyro gain. All in all, a rigid gyro response does ruin the scale look in flight.

Before operating the model check the following points:

- The direction of servo rotation (including the throttle function) and travels.
- The direction of effect of the gyro, and the transmitter mixer functions you have programmed.
- Collective pitch travel (linear travel -2/-3° to +9/+10°)

The blade grips are 14mm, the supplied rotor blades are 12mm thick. We supplied PC washer, please install one washer on top and on the bottom of the rotor blade when installing it to the blade grip.

ATTENTION !

When using the a pitch gauge to adjust correct CP travels, make sure that the gauge lines up with the flat surface of the rotor blade. Many pitch gauges do not show the correct angle when snapped onto non symmetric rotor blades!

The main rotor blades are not symmetrical. Do not try to fly inverted.

- It is permissible to reduce servo travels, but not below 60% (in this case adjust the mechanical linkage); travels should be primarily symmetrical.
- Apply collective pitch min. / collective pitch max. and full roll and pitch-axis commands simultaneously in all directions; rotate the rotor head at the same time, and check that at the extremes of travel no part of the rotor head is obstructed.
- The auto-rotation switch must be assigned, and within easy reach!
- When auto-rotation is selected: throttle position to off, all directions of control and travels as in normal flight, tail rotor to 0° = fixed value.

-The first few batteries should be flown with the model close to the ground, i.e. no more than about 1m altitude, until you are confident that there are no defects or errors, and that everything is working faultlessly:

- Use your ears critically (!), listening for unusual sounds and vibration, and seek out the problem if you are in any doubt at all!
- Don't listen to anyone standing close by if they try to hurry you into flying the model.
- Avoid hovering outside ground effect (hover altitude with a model: approx. 1m, or half the rotor disc diameter):
- Hovering requires very high power, and you are completely dependent on the motor: in contrast to most full-size helicopters, model helicopters have only one (!) power plant.

Step 8 – Installation of mechanics



Fully setup mechanics.



Remove the tail rotor unit as shown.

1. Glue the washers 【38】 into position as shown.

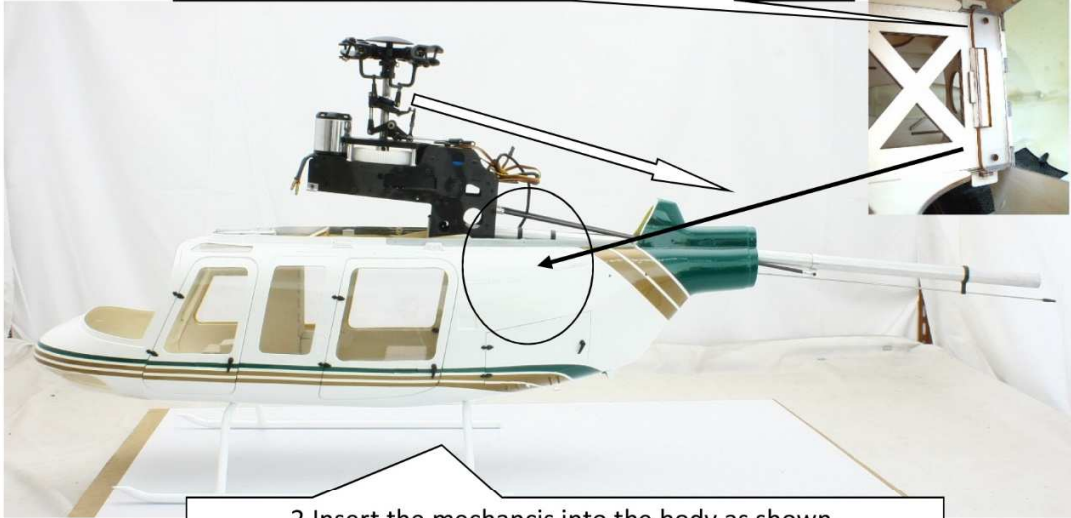

2. Insert the mechanics into the body as shown.

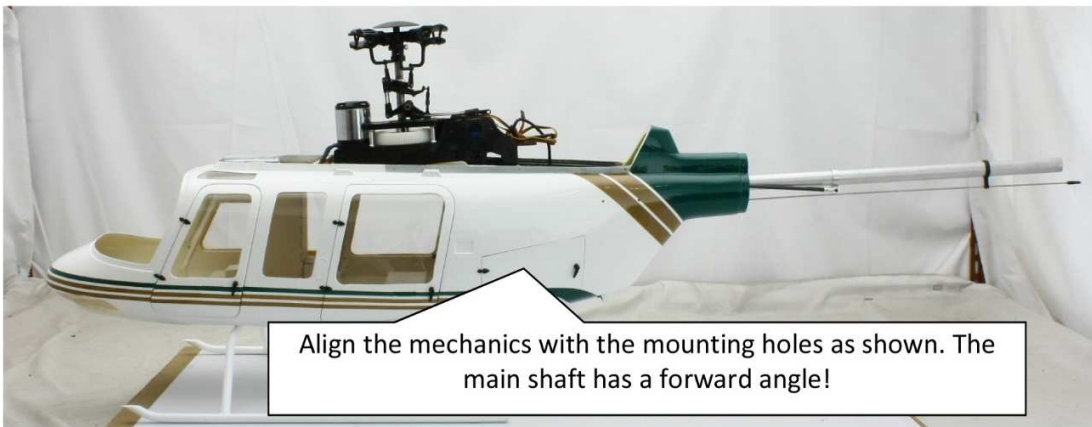

Align the mechanics with the mounting holes as shown. The main shaft has a forward angle!

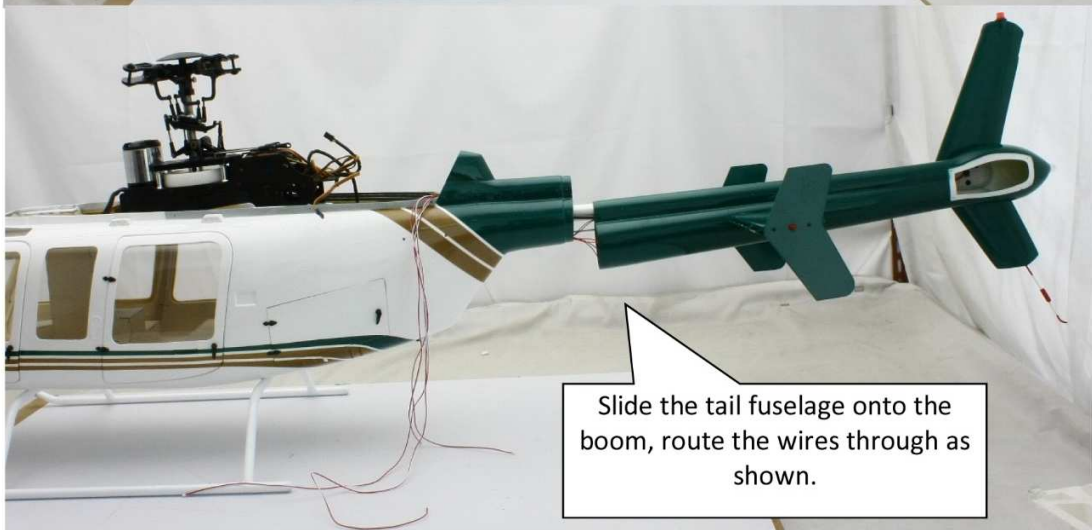

Slide the tail fuselage onto the boom, route the wires through as shown.

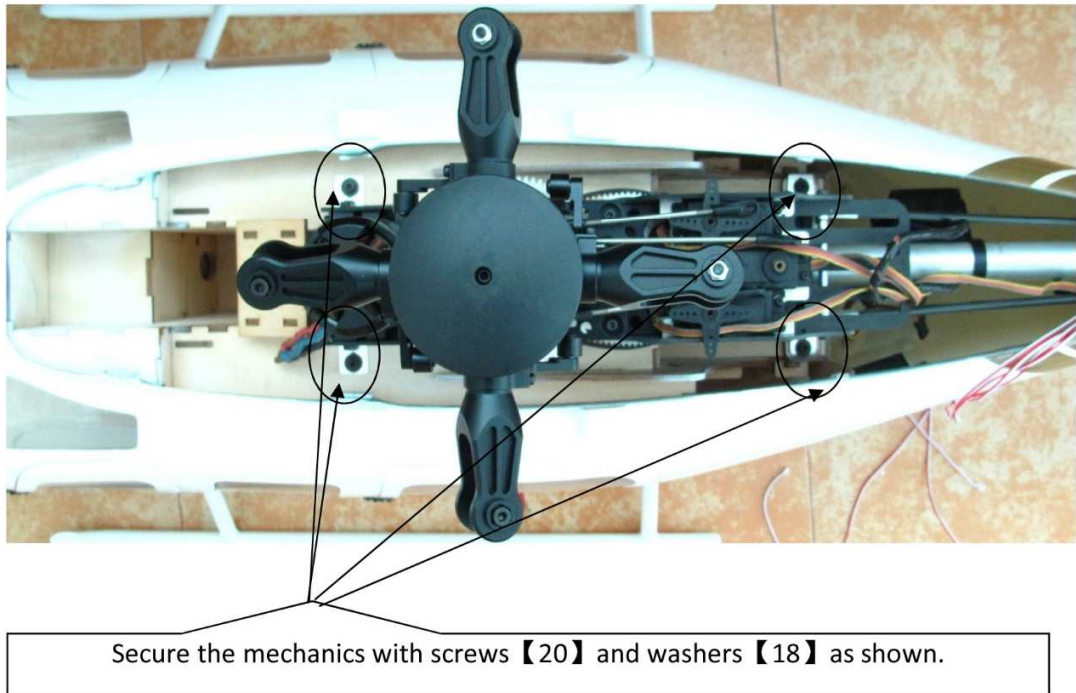
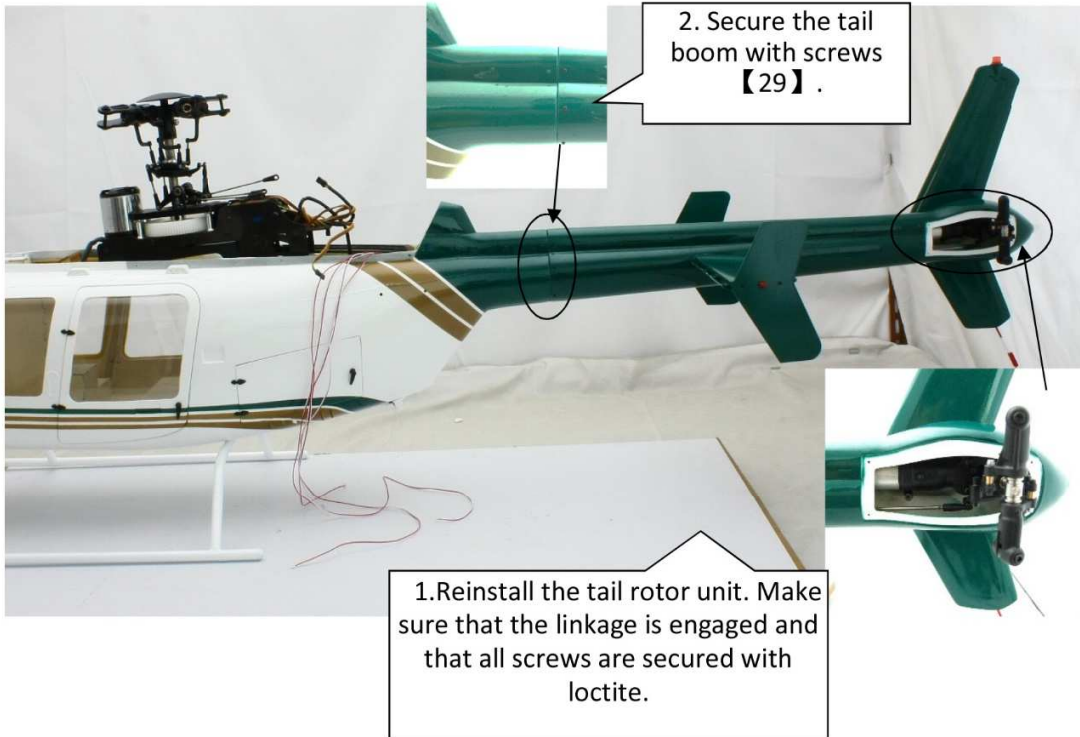

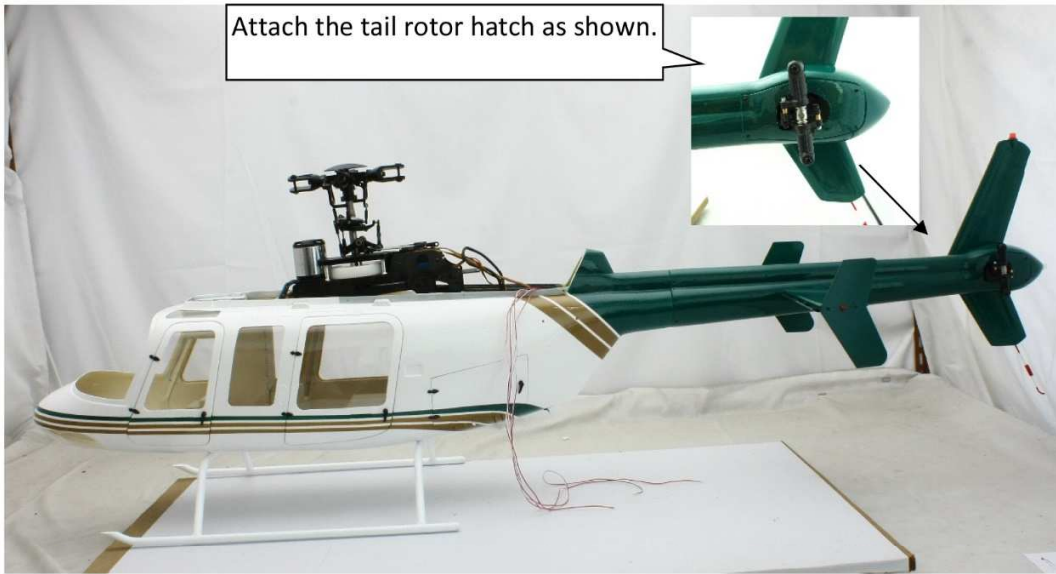

Attach the tail rotor hatch as shown.



Trim both edges by 2mm.



Use the prolonging wire between

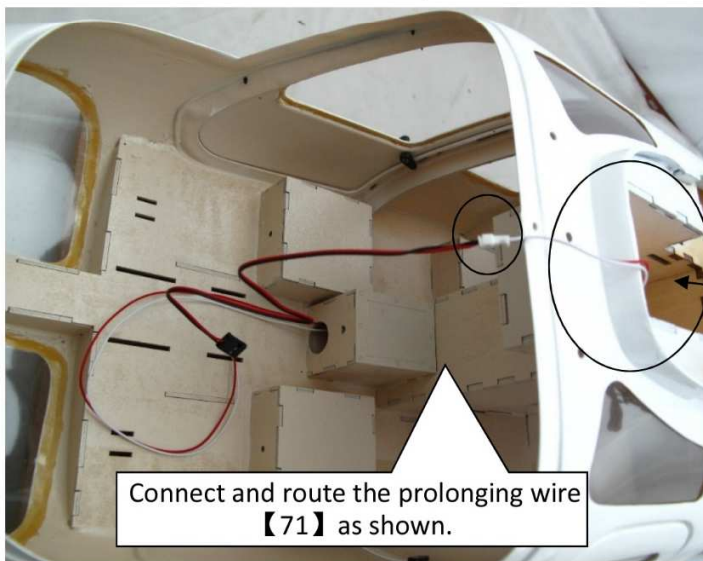

Connect and route the prolonging wire 【71】 as shown.

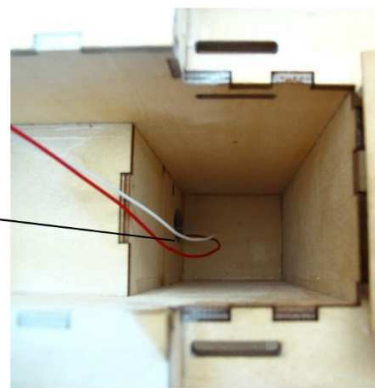

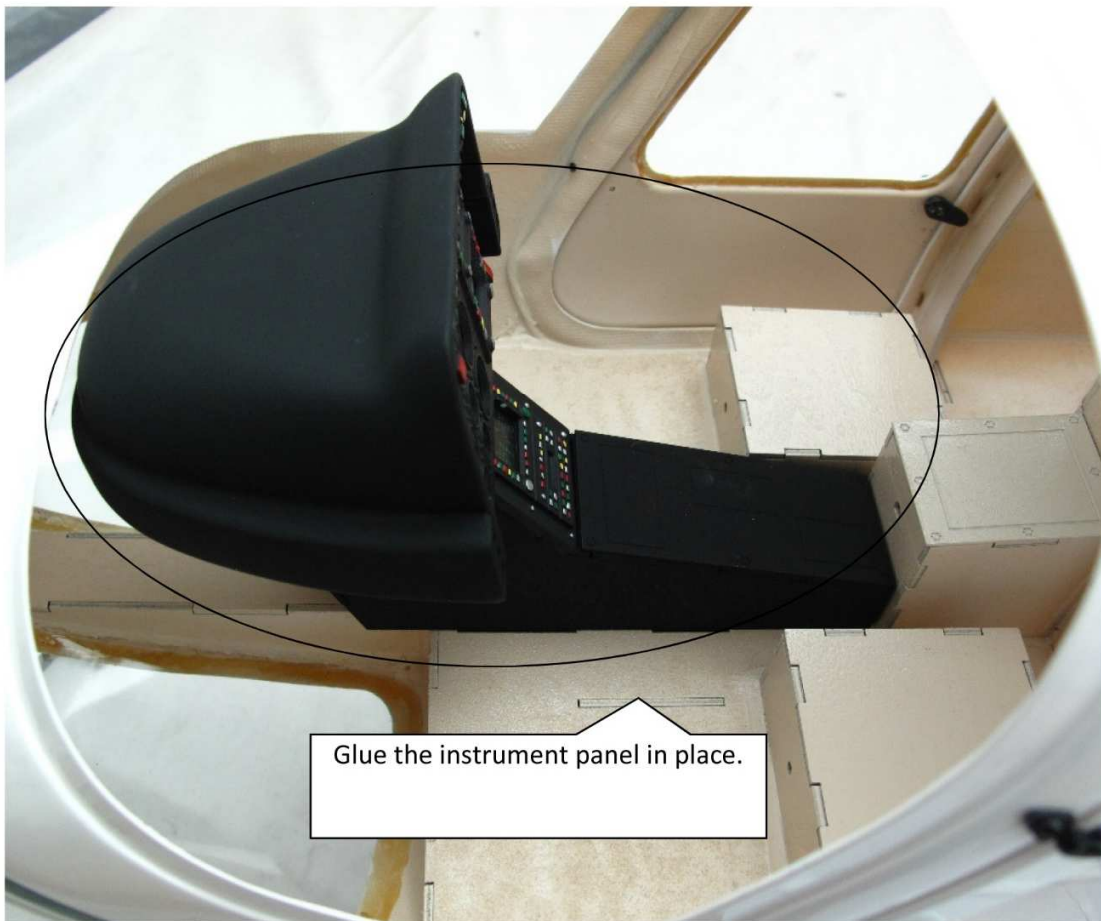
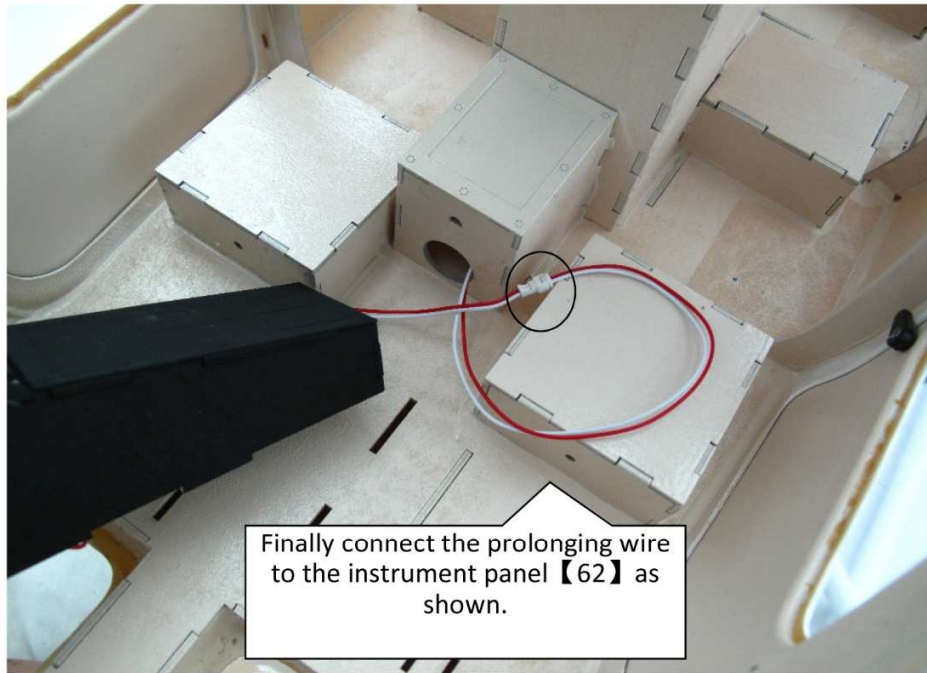

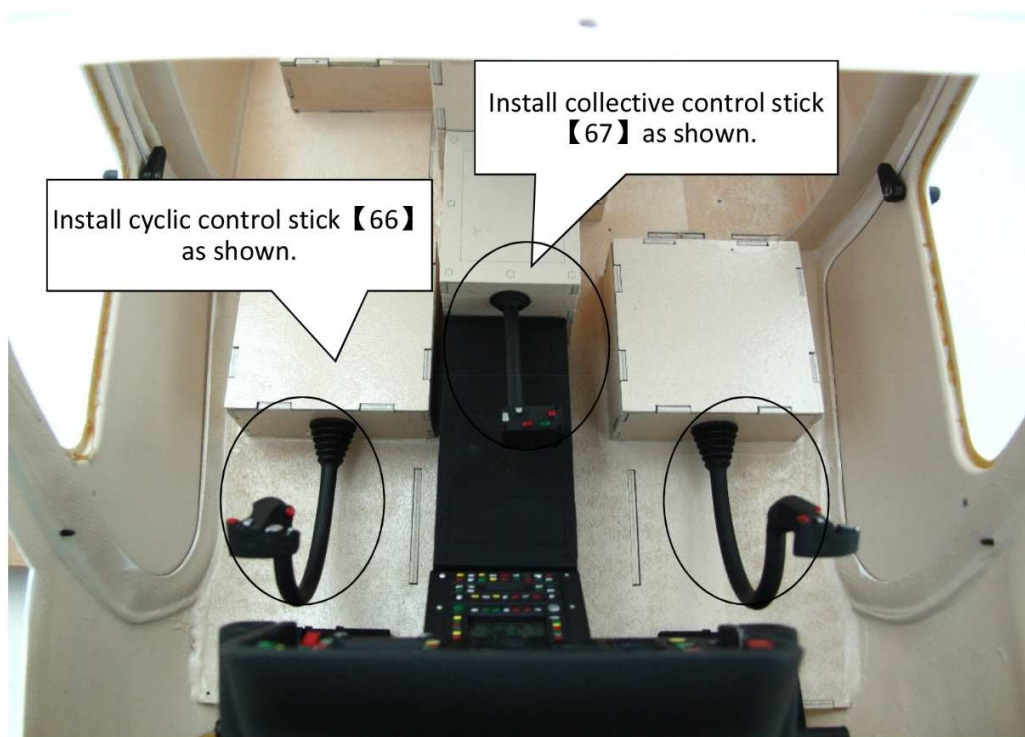
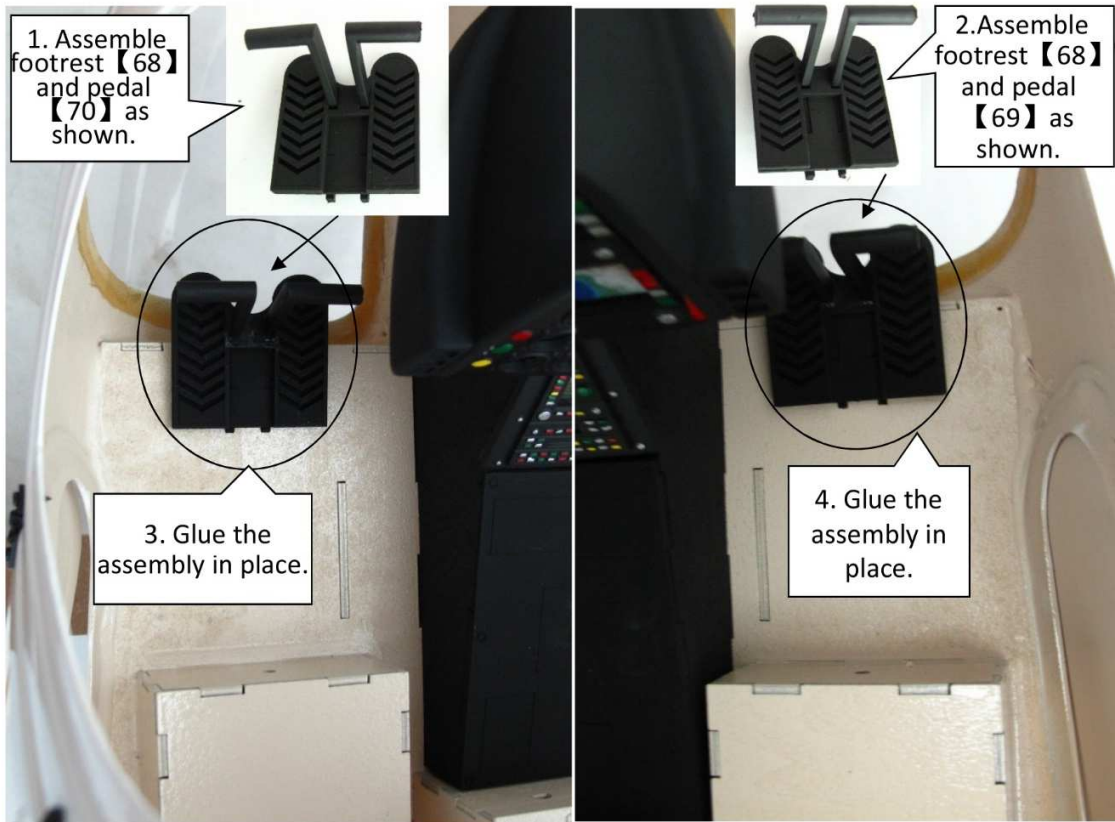



Install front seats **【63】** as shown.



Install rear seat **【63】** as shown.

Install middle seat **【64】** as shown.

Install rear seat **【63】** as shown.

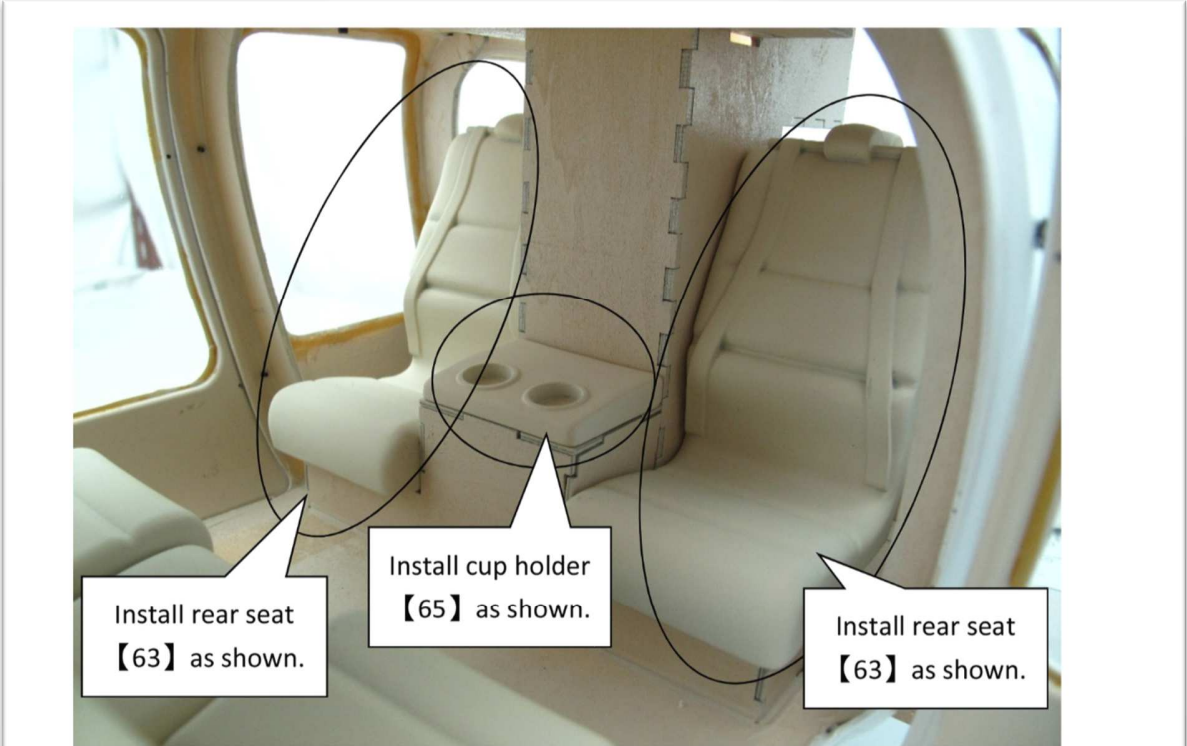

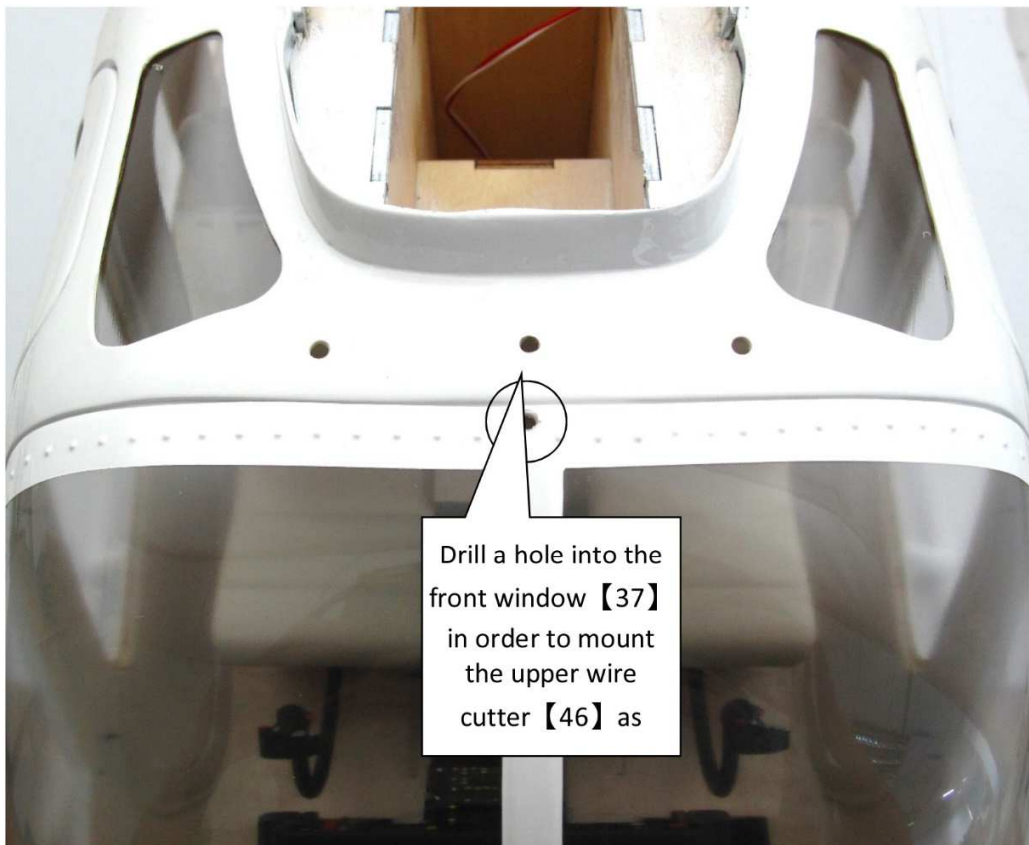

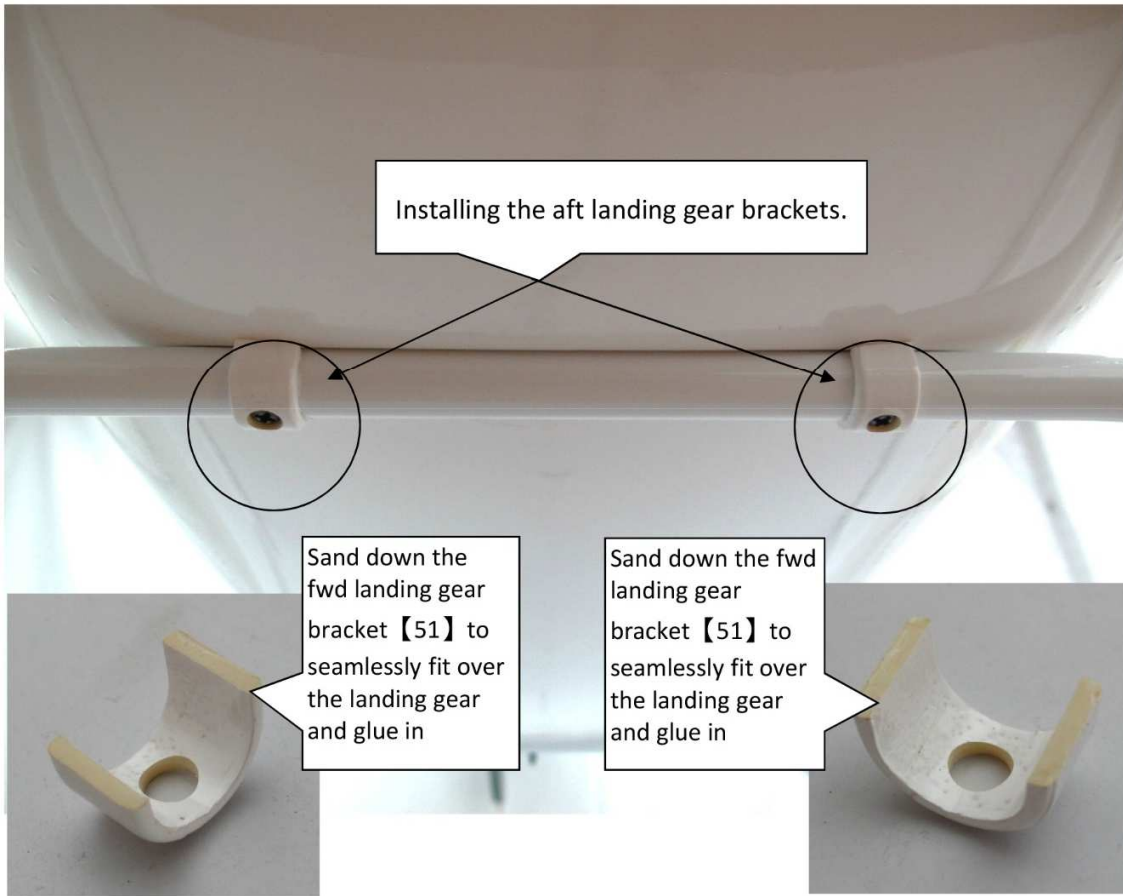
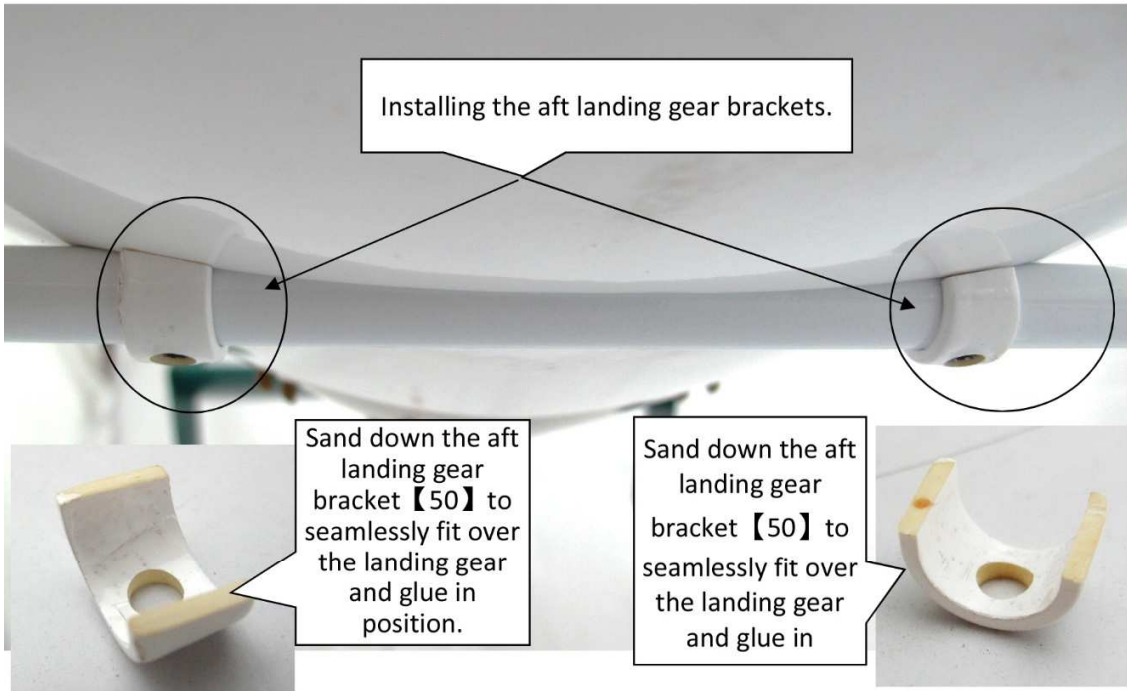

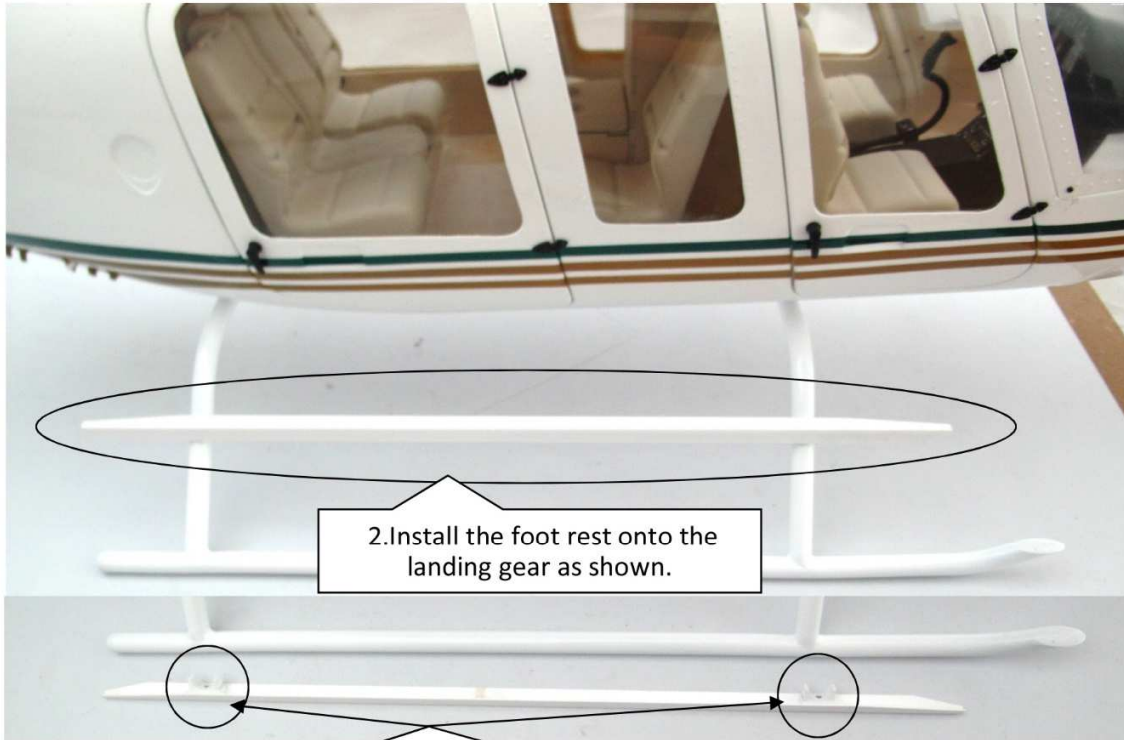

1. Install part 【47】 onto footrest 【53】 as shown.

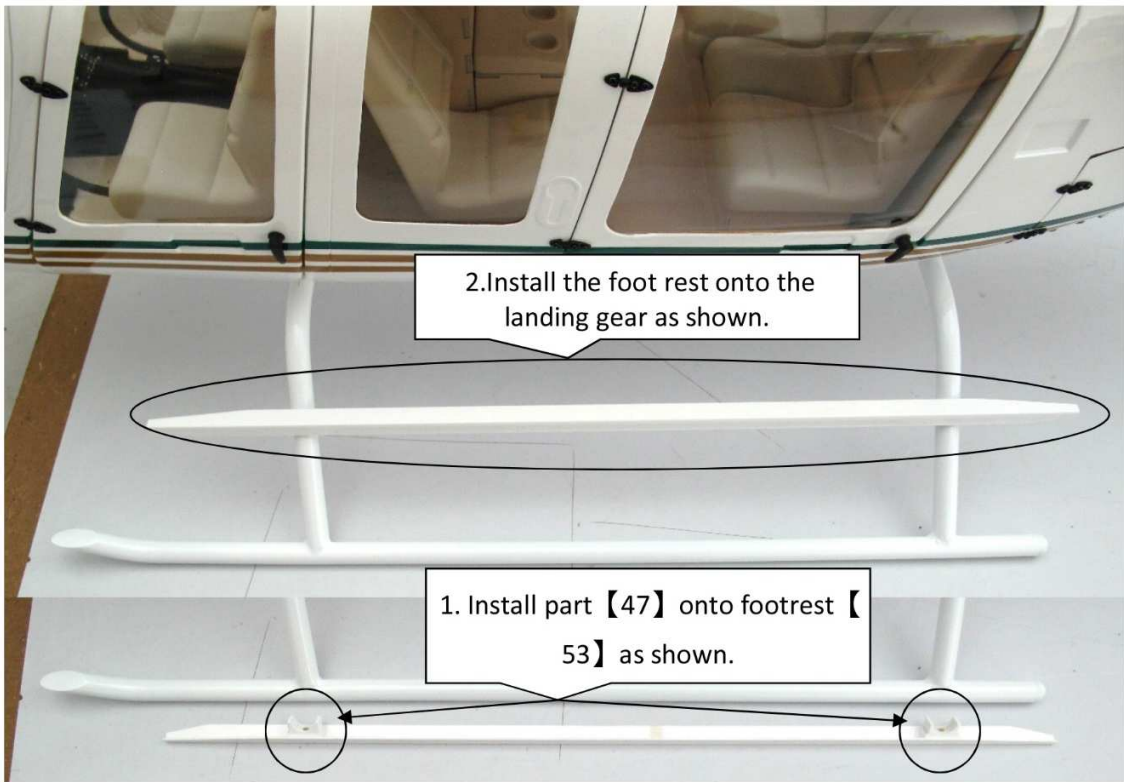

1. Install part 【47】 onto footrest 【53】 as shown.

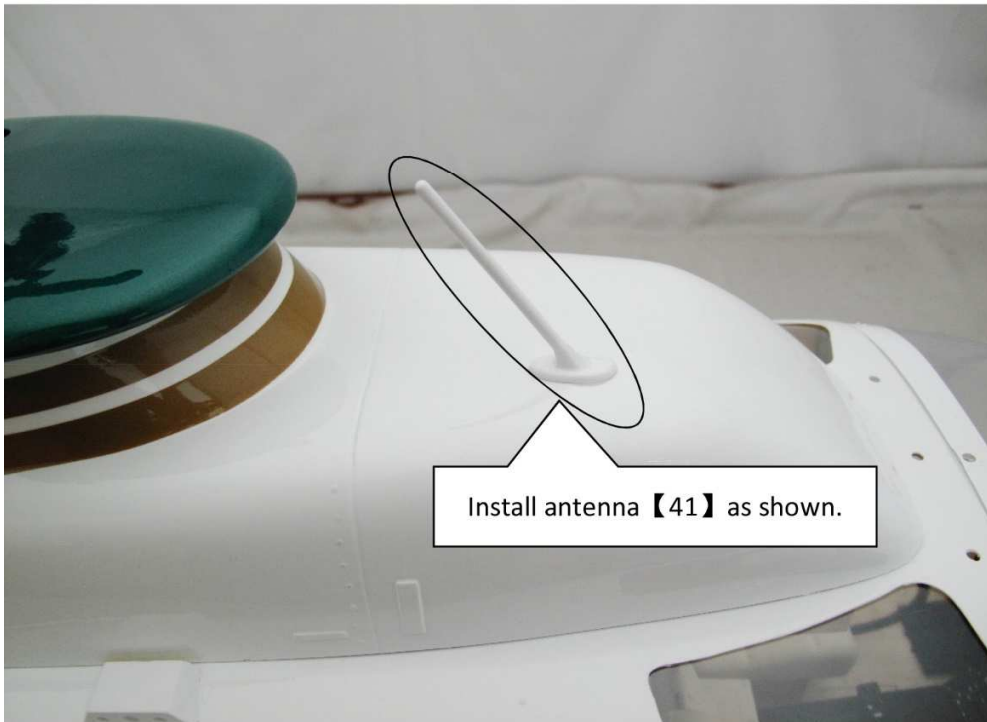

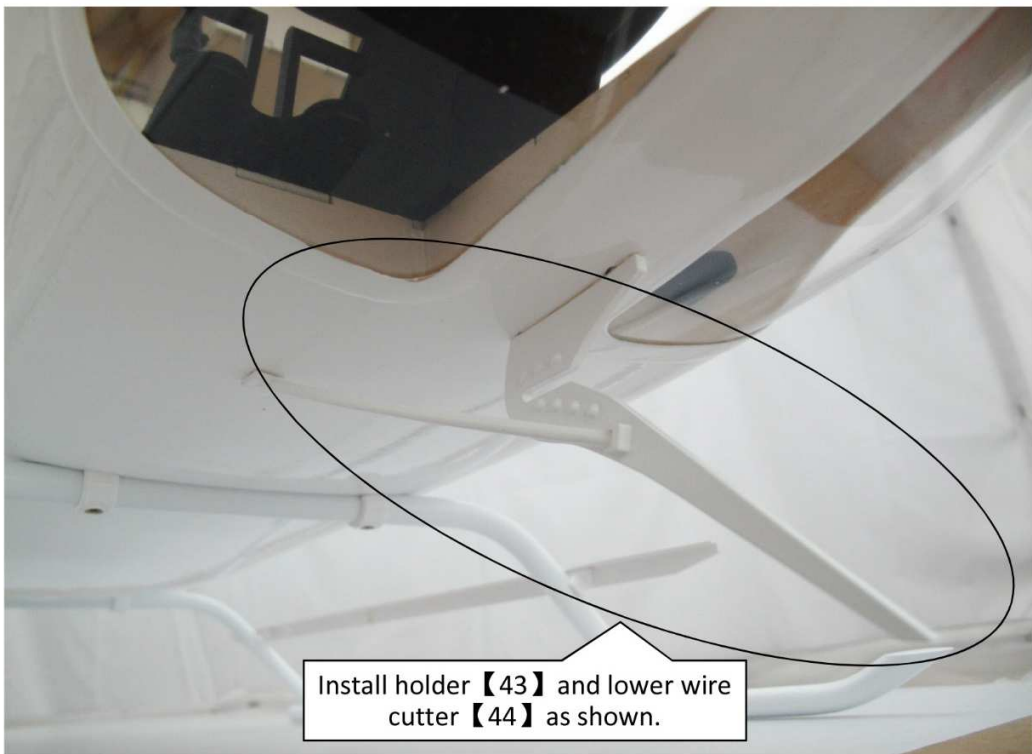



Install scale part **【42】** as shown.



Install foot step **【48】** as shown.

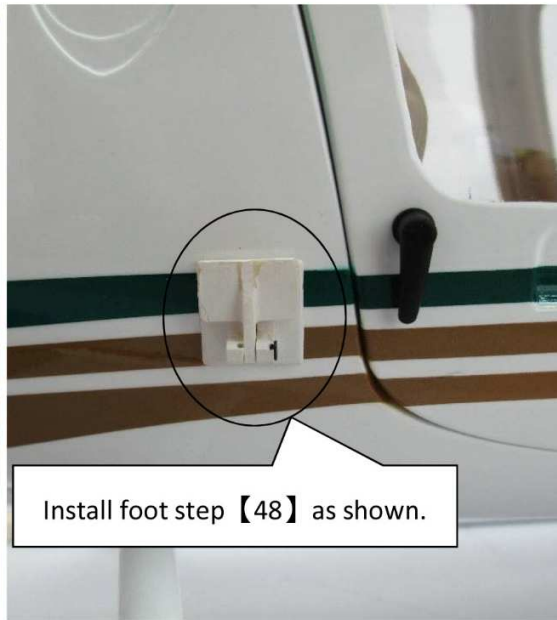

Install foot step **【48】** as shown.

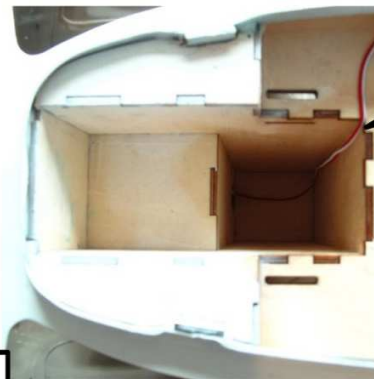

1. Secure the cockpit illumination wire in the battery slot with glue.

2. Installation of the first pack.

3. If your batteries don't allow closing the hatch, remove this battery support.

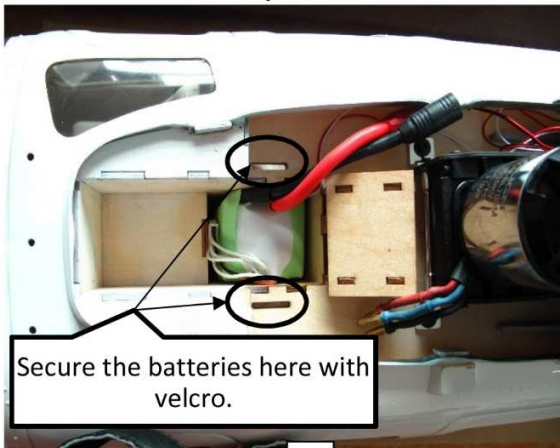

Secure the batteries here with velcro.

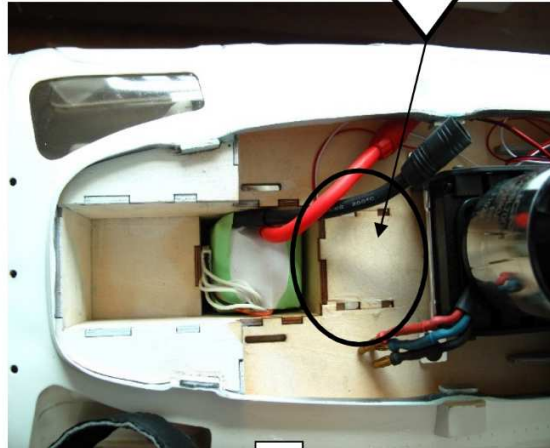

Step 11 - Now it is time to fly

For the first few circuits: starting from ground effect, accelerate to a moderate speed in level flight, and only then initiate a climb, always keep the model flying at a brisk forward speed; on the landing approach always descend towards the landing area at a steady angle (around 45°) directly into wind, and don't bring the model to a halt until it is in ground effect again. This way you can save your model through autorotation. If one particular technical fault keeps recurring in your model, replacing the component concerned will not solve the problem unless you change some other aspect of the operating conditions. It is as hard to fly nice and smooth scale maneuvers as flying F3C or exact 3D figures.

And one final request:

Please be realistic when assessing your piloting skills, because a scale helicopter is heavy and hence much less agile in response than any 3D helicopter. Keep this comparison in mind: if you can't swim and you dive into deep water, the chances are that you will drown.

Appendix A – Explosion Drawings

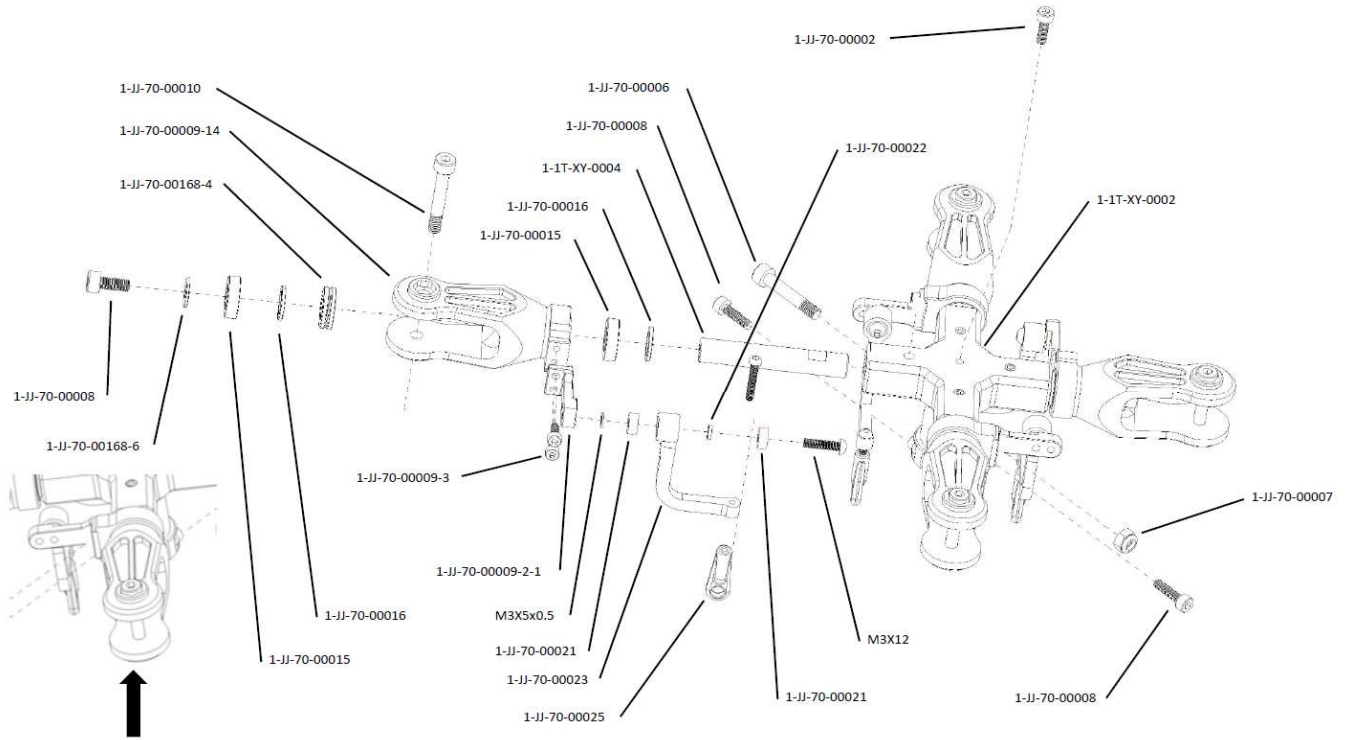

Note: This explosion drawing depicts a clock counter wise spinning rotor head if viewed from above, pitch links are pre-timed by 90 degrees. In a clockwise spinning setup, such as the EC135, the pitch links have to be turned around by 180 degrees before mounting the ball links onto the swashplate.

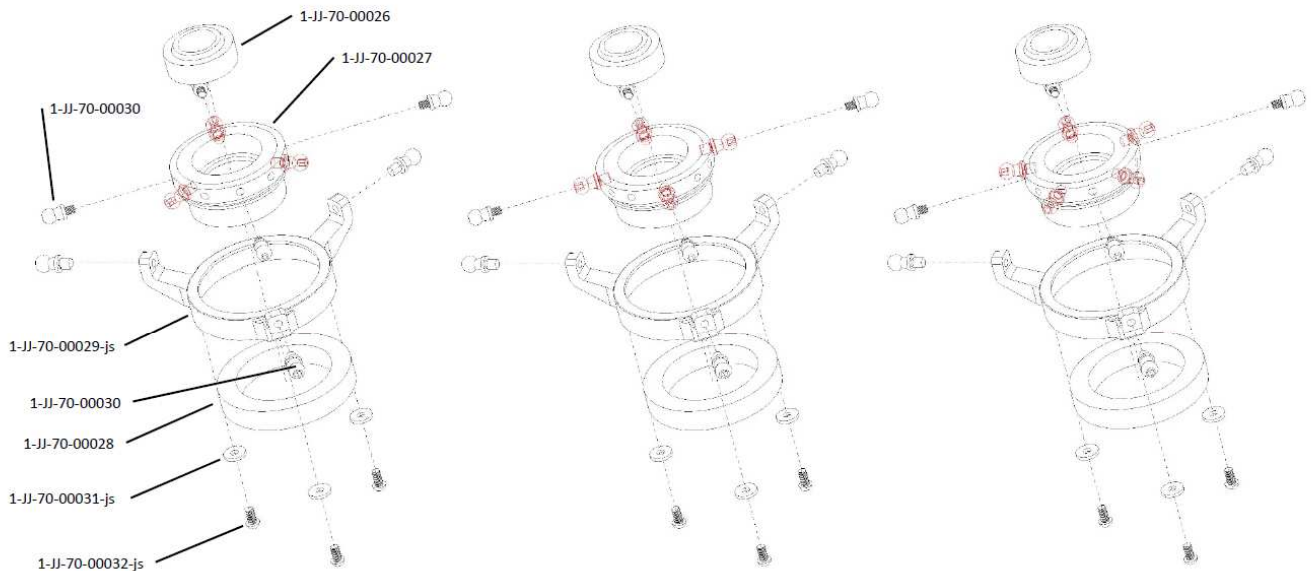

3 blade swash plate

4 blade swash plate

5 blade swash plate

Note: There are various configurations for the swashplate timing, whether through rotorhead L lever or knee-lever on top of the swashplate.

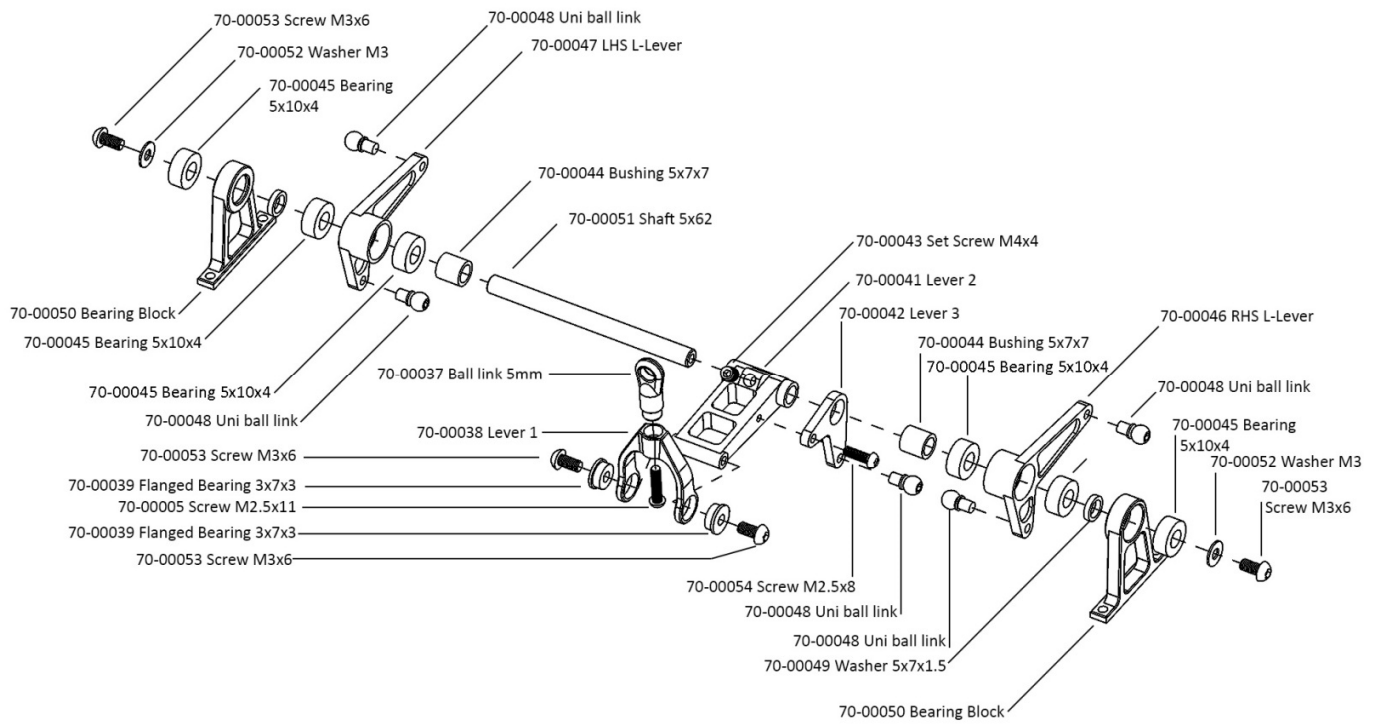

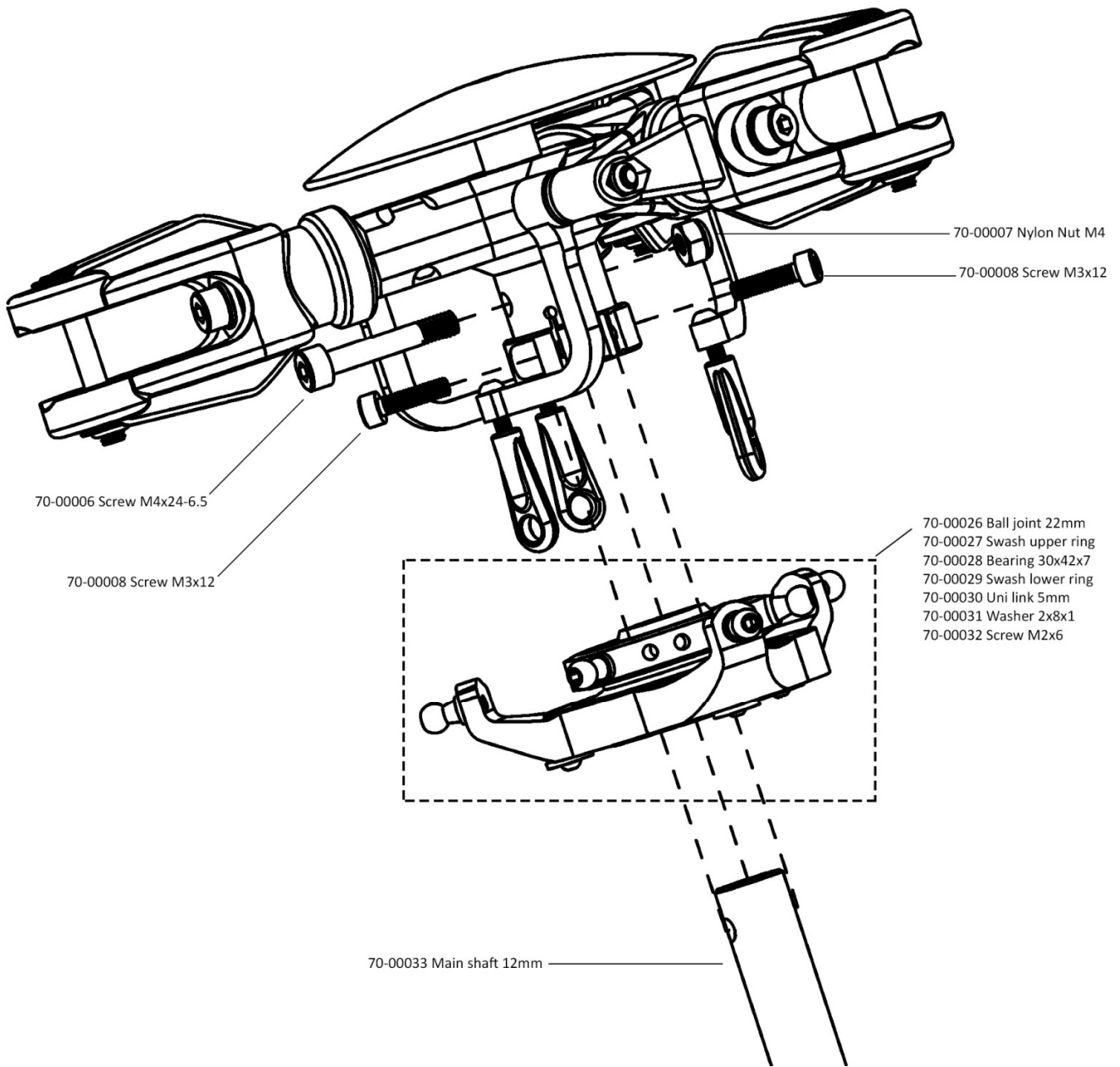

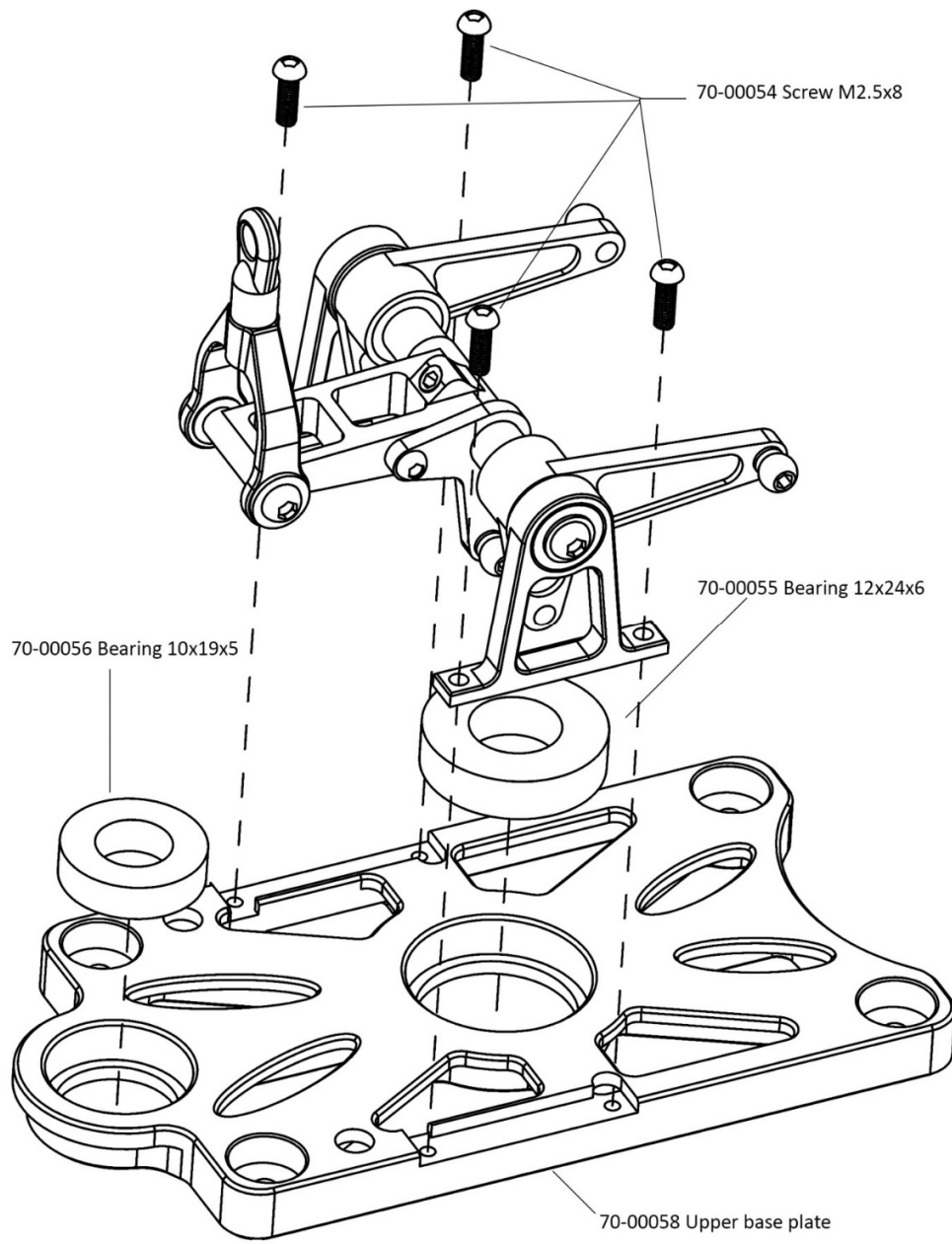

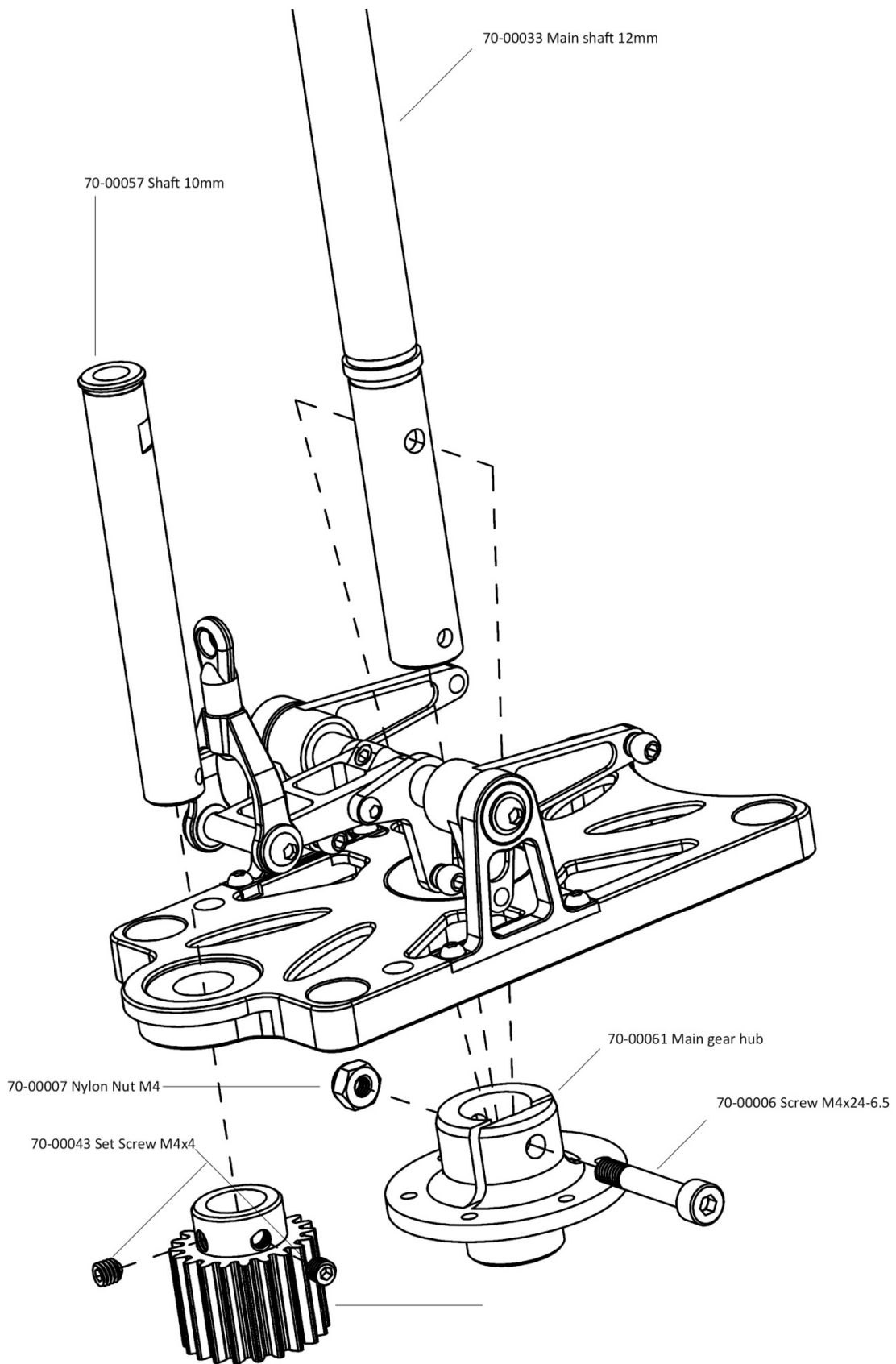

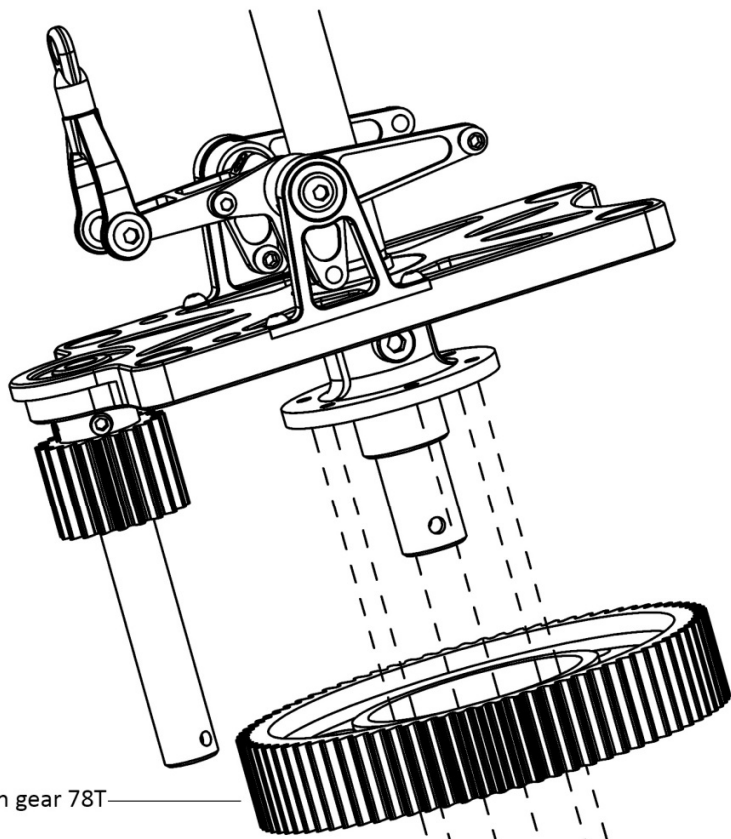

70-00062 Main gear 78T

70-00086 Screw M3x8

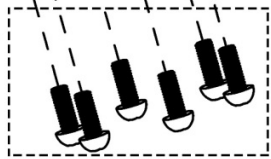

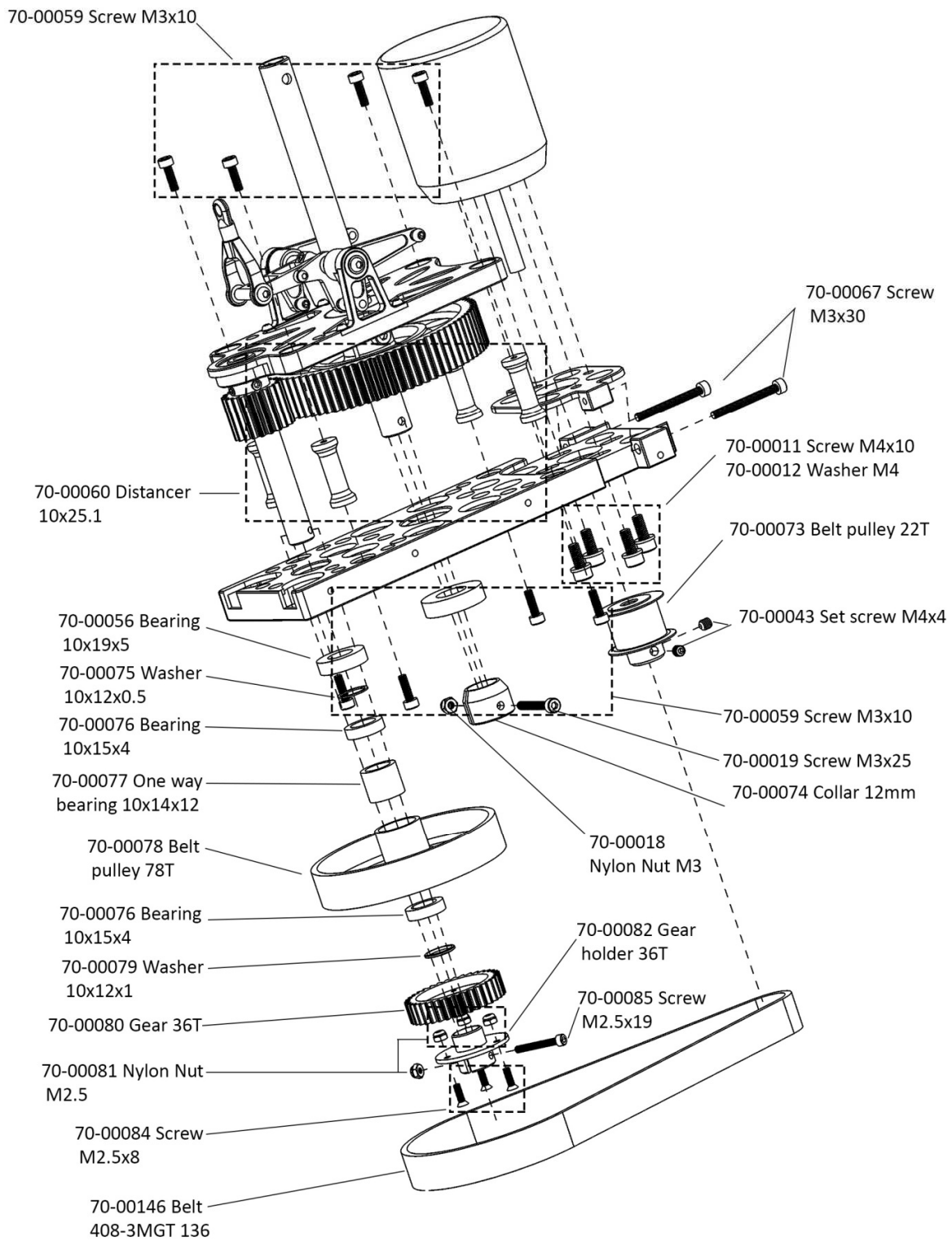

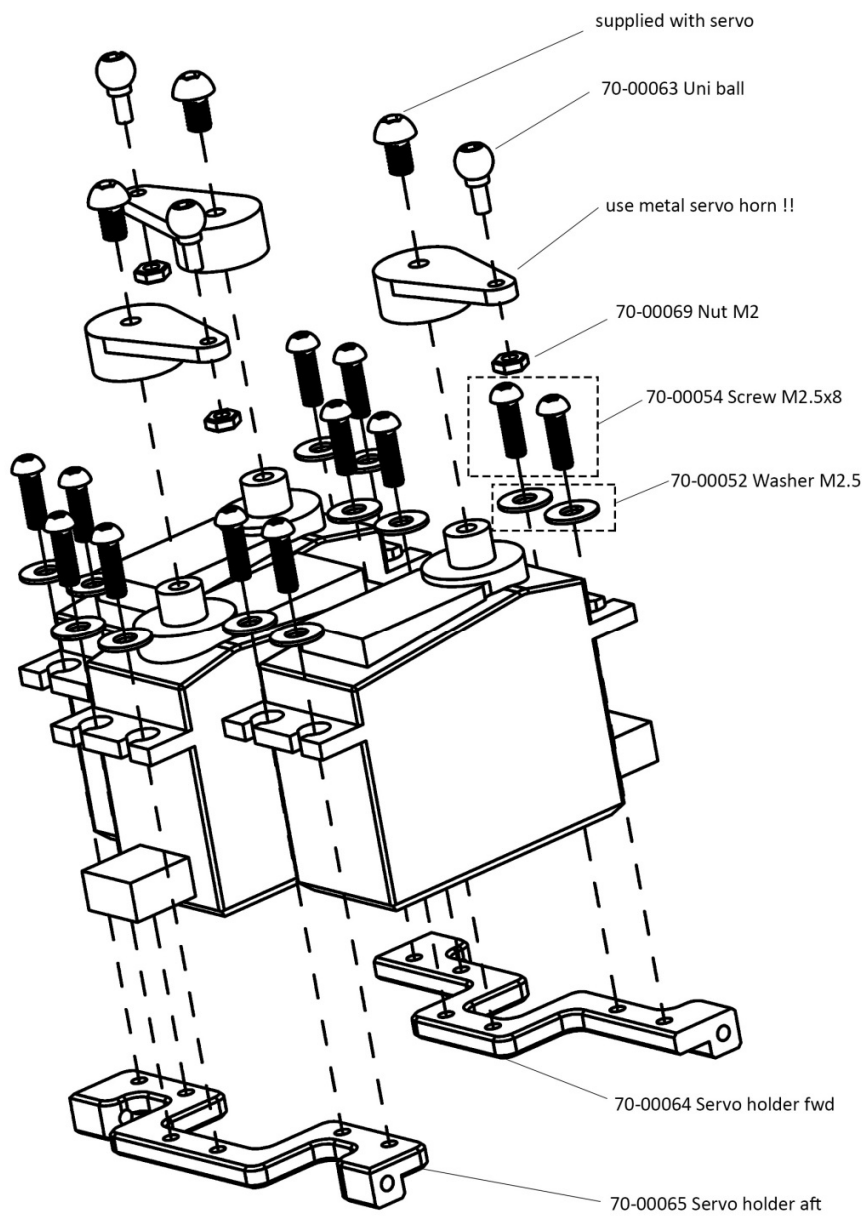

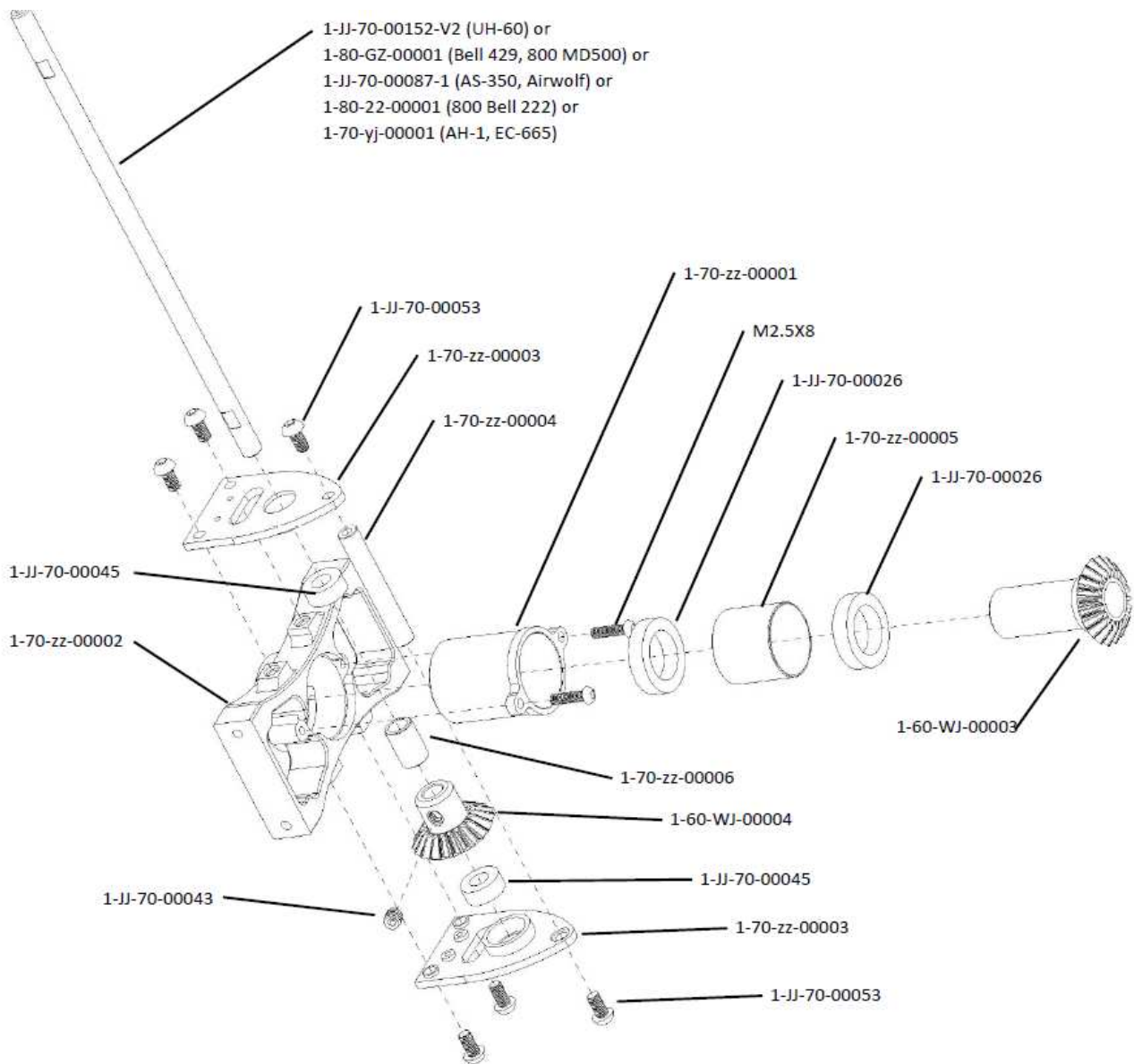



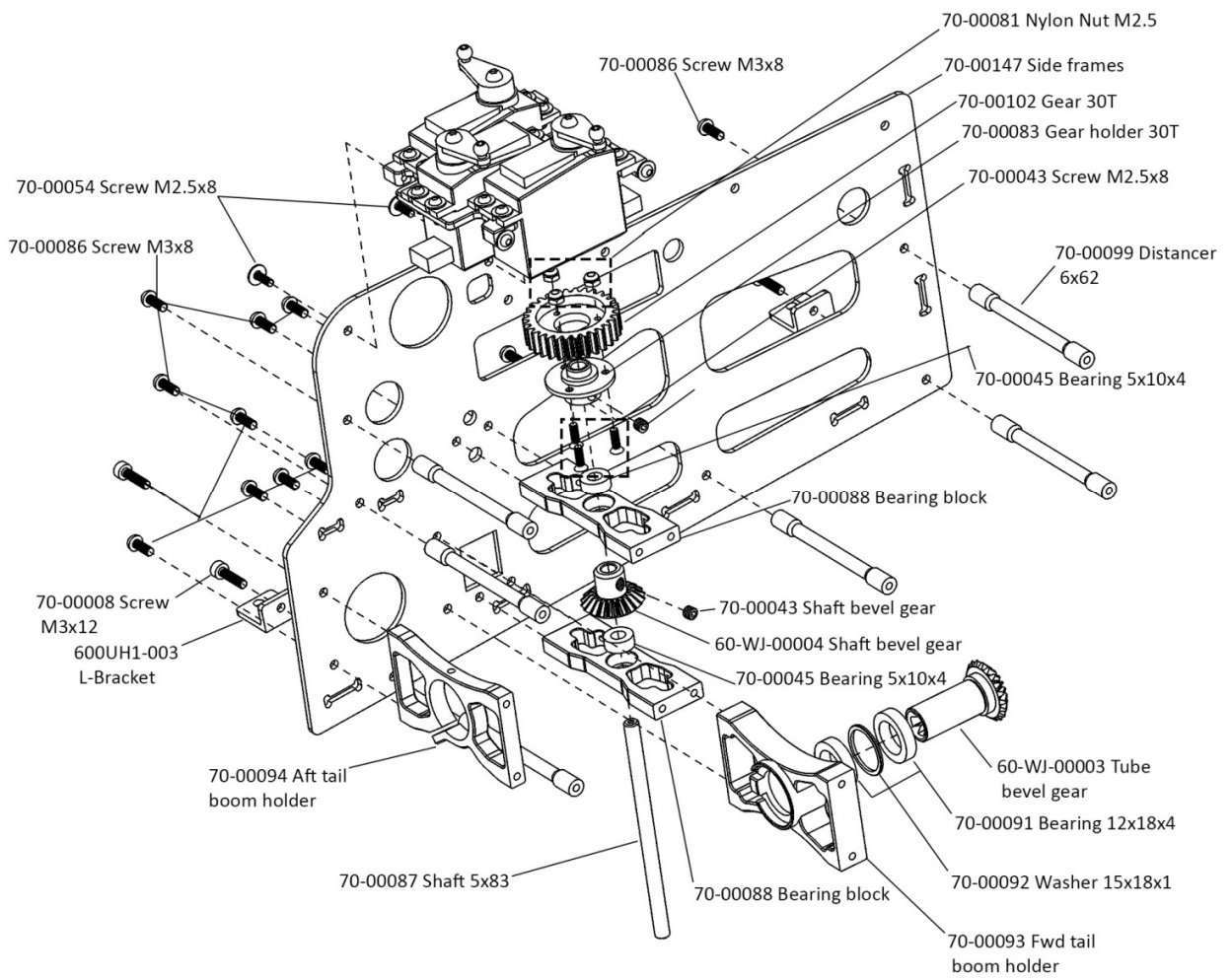

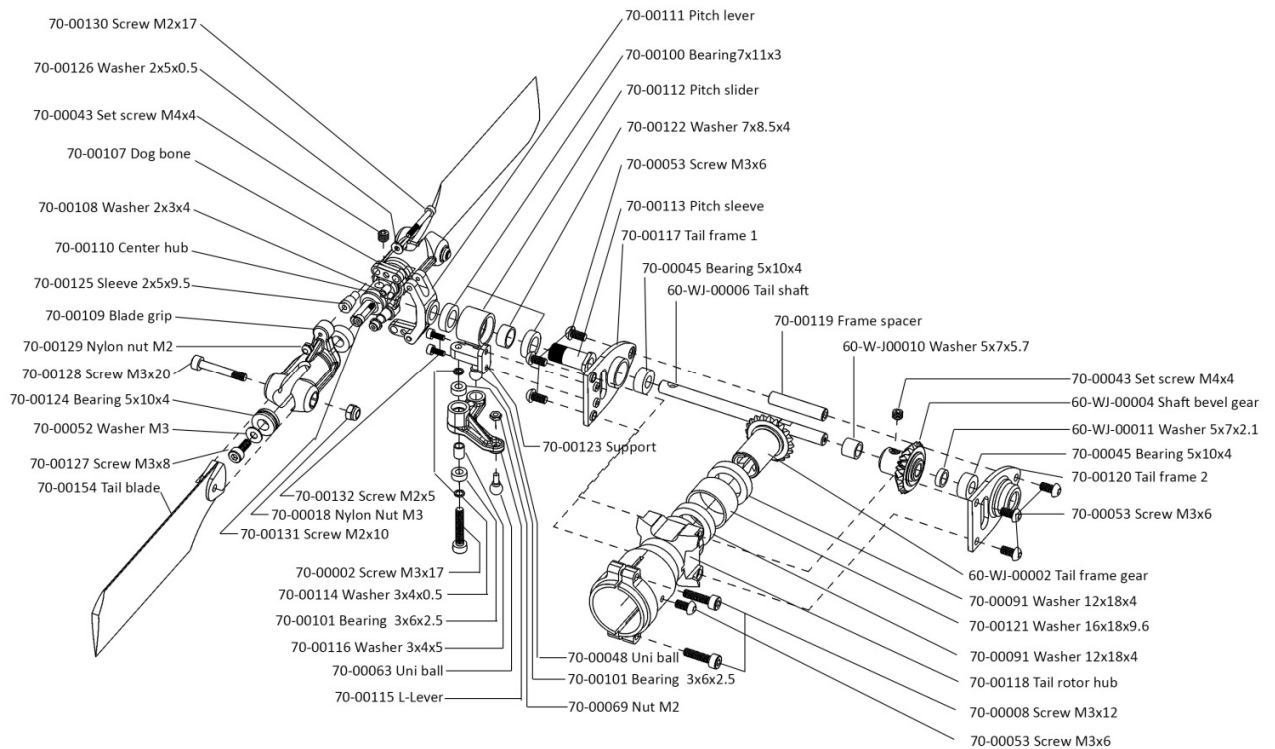
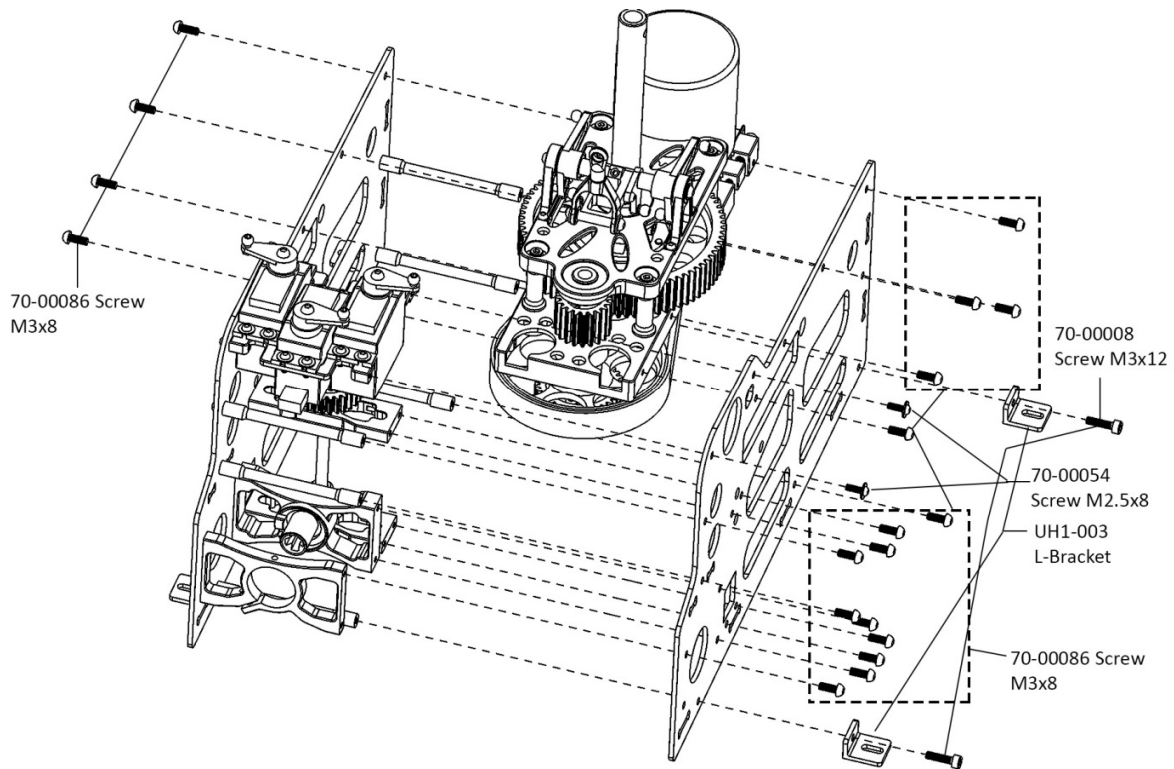



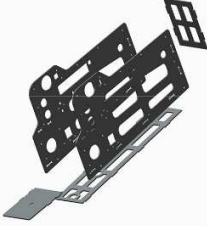





Note: To ensure proper tail rotor rotation and functionality, the input bevel gear (1-60-WJ-00004) and sleeve (1-70-zz-00006) might need to be swapped around.





Appendix B – Spareparts

<p>RCH-70-001-BE222</p> 	<p>RCH-70-002</p> 	<p>RCH-70-003-AW</p> 	<p>RCH-70-004</p> <p style="text-align: center;">N/A</p>
<p>RCH-70-005</p> 	<p>RCH-70-006</p> 	<p>RCH-70-007</p> 	<p>RCH-70-008</p> 
<p>RCH-70-009</p> 	<p>RCH-70-010</p> 	<p>RCH-70-011-BE222</p> 	<p>RCH-70-012</p> 
<p>RCH-70-013</p> 	<p>RCH-70-014</p> 	<p>RCH-70-015</p> 	<p>RCH-70-016</p> 
<p>RCH-70-017</p> 	<p>RCH-70-018</p> 	<p>RCH-70-019-LG</p> 	<p>RCH-70-020</p> 
<p>RCH-70-021-BE222</p> 	<p>RCH-70-022</p>	<p>RCH-70-023</p> 	<p>RCH-70-024</p> <p style="text-align: center;">N/A</p>

<p>RCH-70-025-AW</p> 	<p>RCH-70-026</p> 	<p>RCH-70-027</p> 	<p>RCH-70-028</p> 
<p>RCH-70-029</p> 	<p>RCH-70-030</p> 	<p>RCH-70-031</p> 	<p>RCH-70-032</p> 
<p>RCH-70-033</p> 	<p>RCH-70-034</p> 	<p>RCH-70-035</p> 	<p>RCH-70-036</p> 
<p>RCH-70-037</p> 	<p>RCH-70-038-BE222</p> 	<p>RCH-70-039</p> 	<p>RCH-70-040-BE222</p> 
<p>RCH-70-041-BE222</p> 	<p>RCH-70-042</p> 	<p>RCH-70-043</p> 	<p>RCH-70-044-BE222</p> 
<p>RCH-70-045</p> 	<p>RCH-70-046</p> 	<p>RCH-70-047-BE222</p> 	<p>RCH-70-048</p> 

RCH-70-049 	RCH-70-050 	RCH-70-051 	RCH-70-052 
RCH-70-053-BE222 	RCH-70-054 	RCH-70-055 	RCH-70-056 
RCH-70-057 	RCH-70-058-BE222 	RCH-70-059-BE222 	RCH-70-060 
RCH-70-061 	RCH-70-062 	RCH-70-063 	RCH-70-064 
RCH-70-065 	RCH-70-066 	RCH-70-067 	RCH-70-068 
RCH-70-069 	RCH-70-070 	RCH-70-071 	RCH-70-072 

RCH-70-073

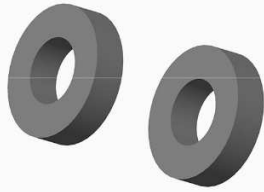

RCH-70-074



RCH-70-075



RCH-70-076



RCH-70-077



RCH-70-078

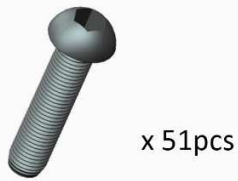

RCH-70-079



RCH-70-080



RCH-70-081



RCH-70-082



RCH-70-083

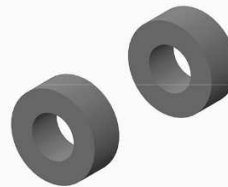

RCH-70-084



RCH-70-085



RCH-70-086

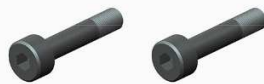

RCH-70-086



RCH-70-088



RCH-70-089

RCH-70-090



RCH-70-091



RCH-70-092

RCH-70-093

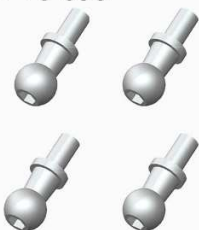

RCH-70-094













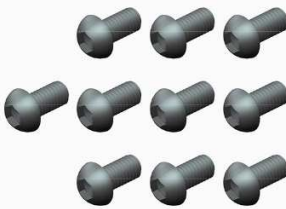
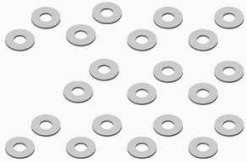

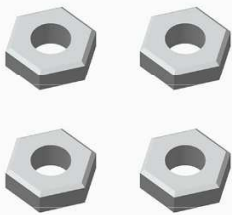

RCH-70-095



RCH-70-096



RCH-70-097 	RCH-70-098 	RCH-70-099 	RCH-70-100 
RCH-70-101 	RCH-70-102 	RCH-70-103 	RCH-70-104 
RCH-70-105 	RCH-70-106 	RCH-70-107 	RCH-70-108 
RCH-70-109 	RCH-70-110 	RCH-70-111 	RCH-70-112 

Appendix C – Sparepart List

RCH-70-001	1-JJ-70-00147	Sideframes	Seitenrahmen
	1-JJ-70-00148	Aft frame	hintere Platte
	1-JJ-70-00149	Bottom frame	Bodenplatte
	1-JJ-70-00150	Fwd frame	vordere Platte
RCH-70-002	1-JJ-70-00099	Distancer 6x62	Distanzstück 6x62
	11-600UH1-003	L-Bracket	L-Halter
RCH-70-003	1-JJ-70-00152	Landing Gear	Fahrwerk
RCH-70-004	1-JJ-70-00153	Footrest	Trittleiste
RCH-70-005	1-JJ-70-00058	Upper base plate	Obere Basisplatte
RCH-70-006	1-JJ-70-00071	Lower base plate	Untere Basisplatte
RCH-70-007	1-JJ-70-00066	Motor holder	Motorhalter
	1-JJ-70-00067	Screw M3x30	Schraube M3x30
RCH-70-008	1-JJ-70-00062	Main Gear 78T	Hauptzahnrad 78T
RCH-70-009	1-JJ-70-00061	Main gear hub	Hauptzahnradaufnahme
RCH-70-010	1-JJ-70-00063	Spur Gear 20T	Ritzel 20T
RCH-70-011	1-JJ-70-00075	Washer 10x12x0.5	Beilagschreibe 10x12x0.5
	1-JJ-70-00076	Bearing 10x15x5	Kugellager 10x15x4
	1-JJ-70-00077	One way bearing 10x14x12	Kugellager 10x14x12
	1-JJ-70-00078	Belt pulley 78T	Riemenrad 78T
	1-JJ-70-00079	Washer 10x12x1	Beilagscheibe 10x12x1
RCH-70-012	1-JJ-70-00080	Gear 1M 36T	Zahnrad 1M 36T
RCH-70-013	1-JJ-70-00082	Gear hub 36T	Zahnradaufnahme 36T
RCH-70-014	1-JJ-70-00083	Gear holder 30T	Zahnradaufnahme 30T
RCH-70-015	1-JJ-70-00073	Belt pinion 22T	Riemenscheibe 22T
RCH-70-016	1-JJ-70-00037	Ball link 5mm	Kugelkopfrahmen 5mm
	1-JJ-70-00038	Lever 1	Hebel 1
	1-JJ-70-00039	Flanged bearing 3x7x3	Kugellager Flansch 3x7x3
RCH-70-017	1-JJ-70-00060	Distancer 10x25.1	Abstandshalter 10x25.1
RCH-70-018	1-JJ-70-00074	Collar 12mm	
RCH-70-019	1-JJ-70-00033	Main Shaft 12mm	Hauptwelle 12mm
RCH-70-020	1-JJ-70-00057	Shaft 10x76.1	Welle 10x76.1
RCH-70-021	1-JJ-70-00026	Ball joint 22mm	Kugelgelenk 22mm
	1-JJ-70-00027	Swash upper ring	Taumelscheibe Oberteil
	1-JJ-70-00028	Bearing 30x42x7	Kugellager 30x42x7
	1-JJ-70-00029	Swash lower ring	Taumelscheibe Unterteil
	1-JJ-70-00030	Ball head	Kugelkopf
	1-JJ-70-00031	Washer 2x8x1	Beilagscheibe 2x8x1
	1-JJ-70-00032	Screw M2x6	Schraube M2x6
RCH-70-022	1-JJ-70-00003	Rotorhead top	Rotorkopf oben
	1-JJ-70-00004	Rotorhead bottom	Rotorkopf unten
RCH-70-023	1-JJ-70-00001	Rotorhead Cap	Rotorkopfkappe

RCH-70-024	1-JJ-70-00017	Grip Spindle	Blattlagerwelle
RCH-70-025	1-JJ-70-00020	Washer 3x9x1.5	Beilagscheibe 3x9x1.5
	1-JJ-70-00021	Bearing 3x7x3	Kugellager 3x7x3
	1-JJ-70-00022	Washer 3x4.5x1.1	Beilagscheibe 3x4.5x1.1
	1-JJ-70-00023	L-Lever	L-Hebel
	1-JJ-70-00019	Screw M3x25	Schraube M3x25
	1-JJ-70-00018	Self Locking Nut M3	Stopfmutter M3
RCH-70-026	1-JJ-70-00024	Screw M2.5x16	Schraube M2.5x16
	1-JJ-70-00025	Ball link 5mm	Kugelkopf 5mm
RCH-70-027	1-JJ-70-00012	Washer 4x8x1	Beilagscheibe 4x8x1
	1-JJ-70-00014	Washer 8x14x0.5	Beilagscheibe 8x14x0.5
	1-JJ-70-00016	Washer 8x11.5x1.3	Beilagscheibe 8x11.5x1.3
RCH-70-028	1-JJ-70-00009	Main Blade Grip	Hauptrotorblatthalter
RCH-70-029	1-JJ-70-00034	Lever 23mm	Gestänge 23mm
	1-JJ-70-00035	Lever 67mm	Gestänge 67mm
	1-JJ-70-00036	Gestänge 98mm	Gestänge 98mm
RCH-70-030	1-JJ-70-00046	Right servo lever	Rechter Servohebel
	1-JJ-70-00047	Left servo lever	Linker Servohebel
RCH-70-031	1-JJ-70-00050	Bearing Block	Lagerbock
RCH-70-032	1-JJ-70-00041	Lever 2	Hebel 2
RCH-70-033	1-JJ-70-00042	Lever 3	Hebel 3
RCH-70-034	1-JJ-70-00044	Bushing 5x7x7	Buchse 5x7x7
	1-JJ-70-00049	Washer 5x7x1.5	Beilagscheibe 5x7x1.5
	1-JJ-70-00051	Shaft 5x62	Welle 5x62
RCH-70-035	1-JJ-70-00064	Servo holder fwd	Servohalter vorne
	1-JJ-70-00065	Servo holder aft	Servohalter hinten
RCH-70-036	1-JJ-70-00068	Uniball 5mm	Uniball 5mm
RCH-70-037	1-JJ-70-00088	Bearing block	Lagerbock
RCH-70-038	1-JJ-70-00087	Tail shaft 5x83	Welle 5x83
	1-60-WJ-00003	Tube bevel gear	Kegelrad
	1-JJ-70-00092	Washer 15x18x1	Beilagscheibe 15x18x1
RCH-70-039	1-JJ-70-00093	Tail boom holder fwd	Heckrohrhalter vorne
	1-JJ-70-00094	Tail boom holder aft	Heckrohrhalter hinten
RCH-70-040	1-JJ-70-00095	Tail boom	Heckrohr
RCH-70-041	1-JJ-70-00096	Tail boom shaft	Heckrohrwelle
	12-02-02006	Bearing holder	Kugellagerhalter
	11-600jRCH-70-002	X Junction	X-Verbinder
RCH-70-042	1-JJ-70-00097	Tail servo frame	Heckservorahmen
	1-JJ-70-00098	Tail servo clamp	Heckservoklammer
RCH-70-043	1-JJ-70-00102	Gear 1M 30T	Zahnrad 1M30T
RCH-70-044	1-JJ-70-00103	Tail pushrod 702mm	Gestänge 702mm
RCH-70-045	1-JJ-70-00104	Tail support holder	Strebenaufnahme
	1-JJ-70-00105	Bolt 1.5x7.8	Bolzen 1.5x7.8
	1-JJ-70-00106	Tail support rod	Heckstrebe

RCH-70-046	11-600UH1-007	Tail support clamp	Heckstrebenklammer
RCH-70-047	1-60-WJ-00010	Washer 5x7x5.7	Hülse 5x7x5.7
	1-60-WJ-00011	Washer 5x7x2.1	Beilagscheibe 5x7x2.1
	1-60-WJ-00006	Tail shaft 2 blade	Heckwelle 2 Blatt
RCH-70-048	1-JJ-70-00121	Washer 16x18x9.6	Hülse 16x18x9.6
	1-60-WJ-00002	Tail frame gear	Kegelrad Heck
RCH-70-049	1-JJ-70-00110	Center hub	Heckrotorkopf
RCH-70-050	1-JJ-70-00111	Pitch lever	Pitchhebel
	1-JJ-70-00112	Pitch slider	Pitchschieber
	1-JJ-70-00113	Pitch sleeve	Pitchhülse
	1-JJ-70-00122	Washer 7x8.5x4	Hülse 7x8.5x4
RCH-70-051	1-JJ-70-00107	Dog bone	Hundeknochen
	1-JJ-70-00108	Washer 2x3x4	Hülse 2x3x4
	1-JJ-70-00125	Sleeve 2x5x9.5	Hülse 2x5x9.5
	1-JJ-70-00126	Washer 2x5x0.5	Beilagscheibe 2x5x0.5
	1-JJ-70-00130	Screw M2x17	Schraube M2x17
RCH-70-052	1-JJ-70-00123	Support	Halterung
RCH-70-053	1-JJ-70-00114	Washer 3x4x0.5	Beilagscheibe 3x4x0.5
	1-JJ-70-00115	L-Lever	L-Hebel
	1-JJ-70-00116	Washer 3x4x5	Hülse 3x4x5
RCH-70-054	1-JJ-70-00119	Frame spacer	Distanzstück
RCH-70-055	1-JJ-70-00117	Tail frame 1	Heckrahmen 1
RCH-70-056	1-JJ-70-00120	Tail frame 2	Heckrahmen 2
RCH-70-057	1-JJ-70-00118	Tail rotor hub	Heckhalter
RCH-70-058	1-JJ-70-00136	Tail blade	Heckrotorblatt
	1-JJ-70-00154	Tail blade	Heckrotor
RCH-70-059	1-JJ-70-00151	Main Blade	Hauptrotorblatt
RCH-70-060	1-JJ-70-00146	Main Belt	Zahnriemen
RCH-70-061	1-JJ-70-00002	Screw M3x18	Schraube M3x18
RCH-70-062	1-JJ-70-00005	Screw M2.5x12	Schraube M2.5x12
RCH-70-063	1-JJ-70-00006	Screw M4x24-6.5	Paßschraube M4x24-6.5
RCH-70-064	1-JJ-70-00007	Self Locking Nut M4	Stopfmutter M4
RCH-70-065	1-JJ-70-00008	Screw M3x12	Schraube M3x12
RCH-70-066	1-JJ-70-00010	Screw M4x26-7	Paßschraube M4x26-7#
RCH-70-067	1-JJ-70-00011	Screw M4x10	Schraube M4x10
RCH-70-068	1-JJ-70-00013	Thrust Bearing 6x14x5	Drucklager 6x14x5
RCH-70-069	1-JJ-70-00015	Bearing 8x14x4	Kugellager 8x14x4
RCH-70-070	1-JJ-70-00040	Servo rod guide	Gestängeführung
RCH-70-071	1-JJ-70-00045	Bearing 5x10x4	Kugellager 5x10x4
RCH-70-072	1-JJ-70-00054	Screw M2.5x8	Schraube M2.5x8
RCH-70-073	1-JJ-70-00055	Bearing 12x24x6	Kugellager 12x24x6
RCH-70-074	1-JJ-70-00056	Bearing 10x19x5	Kugellager 10x19x5
RCH-70-075	1-JJ-70-00081	Nylon Nut M2.5	Nylon Mutter M2.5
RCH-70-076	1-JJ-70-00084	Screw M2.5x8	Schraube M2.5x8
RCH-70-077	1-JJ-70-00085	Screw M2.5x20	Schraube M2.5x20

RCH-70-078	1-JJ-70-00086	Screw M3x8	Schraube M3x8
RCH-70-079	1-JJ-70-00090	rotor head 4 blade top	Rotorkopf 4 Blatt oben
	1-JJ-70-00133	rotor head 4 blade bottom	Rotorkopf 4 Blatt unten
RCH-70-080	1-JJ-70-00100	Bearing 7x11x3	Kugellager 7x11x3
RCH-70-081	1-JJ-70-00101	Bearing 3x6x2.5	Kugellager 3x6x2.5
RCH-70-082	1-JJ-70-00109	Blade grip	Rotorblatthalter
RCH-70-083	1-JJ-70-00124	Bearing 5x10x4	Kugellager 5x10x4
RCH-70-084	1-JJ-70-00127	Screw M3x8	Schraube M3x8
RCH-70-085	1-JJ-70-00128	Screw M3x20	Schraube M3x20
RCH-70-086	1-JJ-70-00131	Screw M2x10	Schraube M2x10
RCH-70-087	1-JJ-70-00132	Screw M2x5	Schraube M2x5
RCH-70-088	1-JJ-70-00134	rotor head 5 blade top	Rotorkopf 5 Blatt oben
	1-JJ-70-00135	rotor head 5 blade bottom	Rotorkopf 5 Blatt unten
RCH-70-090	1-JJ-70-00138	Sleeve 2x5x6.5	Hülse 2x5x6.5
	1-JJ-70-00139	Ball Link	Kugelkopfverbinder
RCH-70-091	1-JJ-70-00140	Screw M2x14	Schraube M2x14
RCH-70-092			
RCH-70-093	1-JJ-70-00142	Uniball 5mm	Uniball 5mm
RCH-70-094	1-JJ-70-00143	Pitch lever 4 blade	Pitchhebel 4 Blatt
RCH-70-095	1-JJ-70-00144	Pitch lever 3 blade	Pitchhebel 3 Blatt
RCH-70-096	1-JJ-70-00145	Tail shaft 3/4 blade	Heckwelle 3/4 Blatt
RCH-70-097	1-60-WJ-00015	Washer 12x18x0.1	Beilagscheibe 12x18x0.1
RCH-70-098	1-JJ-70-00043	Set screw M4x4	Madenschraube M4x4
RCH-70-099	1-JJ-70-00053	Screw M3x6	Schraube M3.6
RCH-70-100	1-JJ-70-00052	Washer 3x7x0.5	Beilagscheibe 3x7x0.5
RCH-70-101	1-JJ-70-00048	Ball link 5mm	Kugelkopf 5mm
RCH-70-102	1-JJ-70-00059	Screw M3x10	Schraube M3x10
RCH-70-103	1-JJ-70-00069	Nut M2	Mutter M2
RCH-70-104	1-JJ-70-00091	Bearing 12x18x4	Kugellager 12x18x4
RCH-70-105	1-60-WJ-00004	Shaft bevel gear	Kegelrad 20T
RCH-70-106	1-JJ-70-00089	Washer 10x13x0.1	Beilagscheibe 10x13x0.1
RCH-70-107	1-JJ-70-00129	Nylon Nut M2	Nylon Mutter M2
RCH-70-108	1-JJ-70-00141	Tail spindle	Heckrotor Welle
RCH-70-109	1-JX-47-00115	Rotor hub 3 blade	Rotorkopf 3 Blatt
RCH-70-110	1-JX-47-00103	Rotor hub 4 blade	Rotorkopf 4 Blatt

www.robanmodel.com
www.scaleflying.com

