



BUCKINGHAM PALACE

Palacio de Buckingham

London, England

The world's great architecture

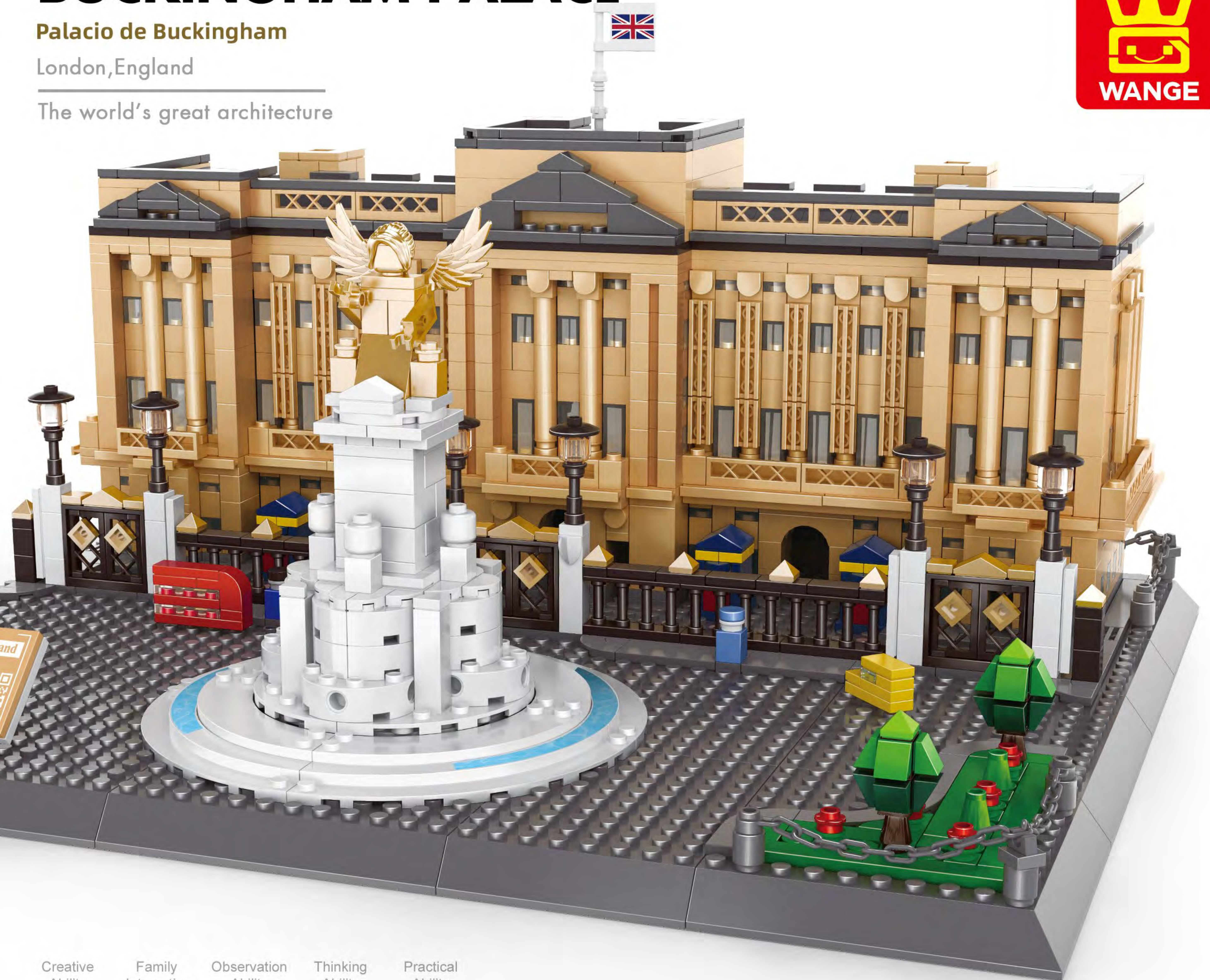

- Creative Ability
- Family Interaction
- Observation Ability
- Thinking Ability
- Practical Ability

6+ / 6224 / 1695 PCS
Suitable Age / Product Number / Parts Total



Architecture

It will be a city...

这将构成一座城市...

ABOUT THE PRODUCT

关于产品



Geography and culture

地理.文化



Creation and thinking

创作.思考



features and functions

特点.功能



Buckingham Palace
NO.6223

ARCHITECTURE

WANGE The world's great architect since 1991

Shantou Wange Educational Material Sci-Tech Co., Ltd.
©2014 Wange / Dubie. All Rights Reserved

Buckingham Palace

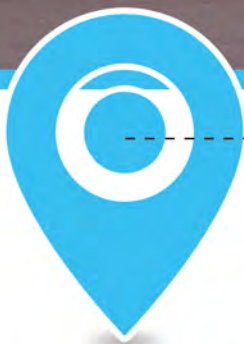

The City of Westminster is the home of Buckingham Palace, which has been the official London-based home of the monarch since 1837, although it is owned by the state.

Buckingham Palace



Geography and culture

地理·文化



Buckingham Palace became the London residence of the British monarch on the accession of Queen Victoria in 1837.





Palacio de Buckingham

Buckingham ■

Palace

England

The contents of this chapter refer to the Wikipedia website.

本章内容参考维基百科网站，更多资讯可自行查阅。

The world's great architecture

Buildings and layout

■ 建筑物和布局



白金汉宫不同于许多国家首都的著名历史建筑，白金汉宫并不是只供游人参观的博物馆。这座宫殿是君主制的中心，是女王陛下作为英国国家元首和英联邦领袖办公和履行礼仪性职责的地方。女王平常会在白金汉宫工作，通常在周末会回到温莎城堡。要知女王在不在宫殿里，只要看一看白金汉宫中央的旗杆就可以了：因为如果女王在宫里，旗杆上飘扬的会是君主旗，否则人们便会看到联合王国旗（即英国国旗）。如遇到盛大的礼仪场合，在天气允许的情况下，宫殿则会挂一面加大号的旗帜。

Possibly the first house erected within the site was that of a Sir William Blake, around 1624. The next owner was Lord Goring, who from 1633 extended Blake's house and developed much of today's garden, then known as Goring Great Garden. He did not, however, obtain the freehold interest in the mulberry garden. Unbeknown to Goring, in 1640 the document "failed to pass the Great Seal before King Charles I fled London, which it needed to do for legal execution". It was this critical omission that helped the British royal family regain the freehold under King George III.



Structure

白金汉宫的建筑风格为新古典主义，主体建筑为五层，其中两层为服务人员使用的附属层，高度较低。所以立面可以视为纵、横三段式处理。白金汉宫建筑外立面装修材料为巴斯石灰岩。内部装修则以人造大理石及青金岩为主。正面广场围以铸铁栅栏，为皇家卫队换岗仪式的场所。广场外为手持权杖、塑造为天使形象的维多利亚女王雕像。宫殿正面向口面向东北方，通过林荫路（The Mall）与特拉法尔加广场相连。

The house which forms the architectural core of the palace was built for the first Duke of Buckingham and Normanby in 1703 to the design of William Winde. The style chosen was of a large, three-floored central block with two smaller flanking service wings. Buckingham House was eventually sold by Buckingham's illegitimate son, Sir Charles Sheffield, in 1761 to George III for £21,000. Sheffield's leasehold on the mulberry garden site, the freehold of which was still owned by the royal family, was due to expire in 1774.



Design and construction

白金汉宫的附属建筑包括皇家画廊、皇家马厩和花园。皇家画廊和皇家马厩均对公众开放参观，其中皇家画廊内收藏有鲁本斯、伦勃朗、弗美尔、盖恩斯巴勒、卡拉内罗等人的绘画作品、卡诺瓦等人的雕塑作品。

Under the new Crown ownership, the building was originally intended as a private retreat for King George III's wife, Queen Charlotte, and was accordingly known as The Queen's House. Remodelling of the structure began in 1762. In 1775, an Act of Parliament settled the property on Queen Charlotte, in exchange for her rights to Somerset House, and 14 of her 15 children were born there. Some furnishings were transferred from Carlton House, and others had been bought in France after the French Revolution of 1789. While St James's Palace remained the official and ceremonial royal residence, the name "Buckingham-palace" was used from at least 1791.

Design Points

结构难点

Angle calculation
角度的计算

$$S=4\pi\cdot r^2$$

$$a^2+b^2=c^2$$

$$\sin^2 a + \cos^2 a = 1$$



Creation and thinking

创作·思考

Special parts

特殊零件的开发利用

$$S=4\pi \cdot r^2$$



WG544
分圆4孔

$$a^2+b^2=c^2$$

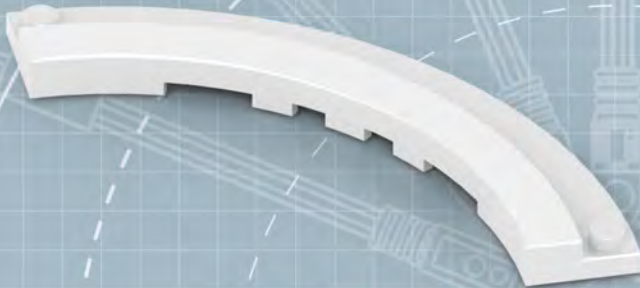

WG1335
台阶圆弧2孔

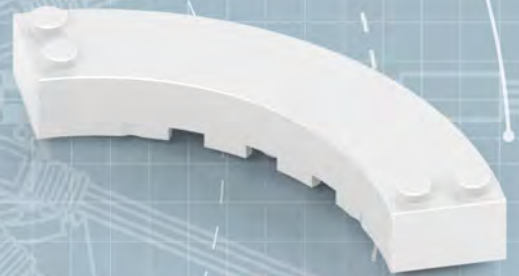

WG1334
高7倍圆弧4孔



WG379
带槽矮长4孔

$$\sin^2 a + \cos^2 a = 1$$



WG220
圆形12孔



features and function

特点.功能

Main Color Matching

配色方案



Pantone Black 6C



Pantone 431C



Pantone 347C



Pantone 285C



Pantone 7620C



Pantone 123C



Pantone Cool Gray 6C

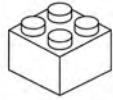

Pantone 4625C



Pantone 7509C



Color matching

Adopting 4 main colors, White, Orange and Red as the main color, the more reasonable and bold color matching on the original building, making the product more atmospheric and the whole design is more reasonable.

Buckingham Palace

英国白金汉宫



Front

Left

Back

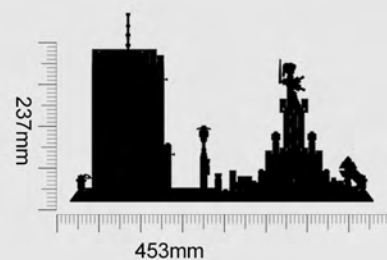
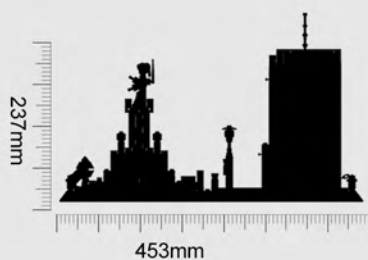
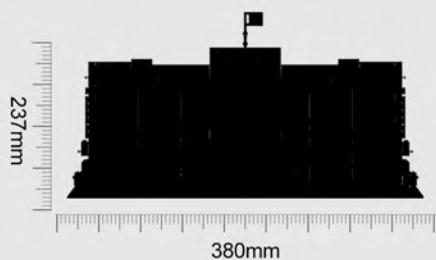

Product Size:453X237X380mm



Instructions For Use

积木起件器使用说明
Brickseparator

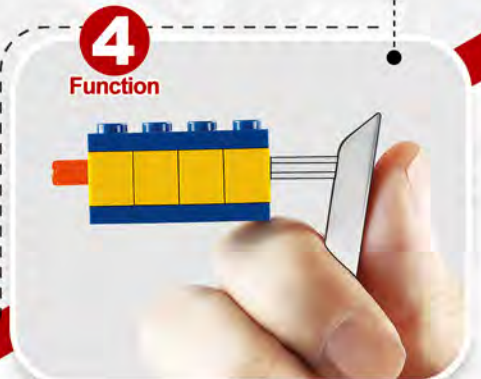
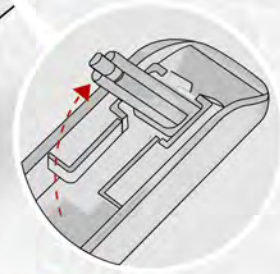
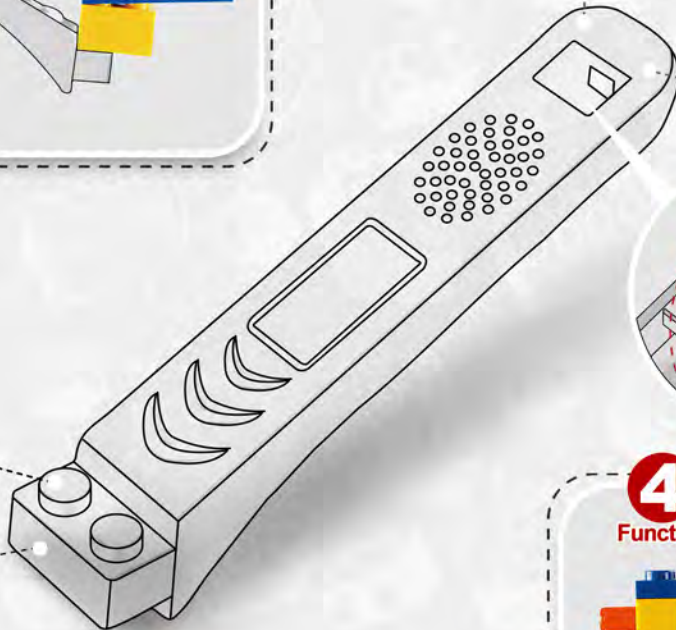
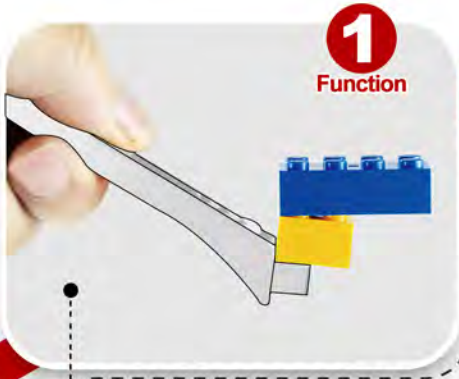

4 ways to make installation easier
让安装更简单



- First open the product packaging according to the instructions.

按指导用正确方式拆解产品外包装。



- Summarize all parts to count the number of familiar accessories.

对照说明书清单确认积木包数量与积木数量。



- Arranging all accessories by color helps to quickly install the product.

把确认好的积木以类型、颜色进行分类排好以便安装。



- Carefully install the product and learn about building.

按说明书步骤拼装并完成你的积木模型。



1:1 Physical Reference Table

十字棒配件1:1尺寸参照表

1:1

Instructions For Use
让安装更简单

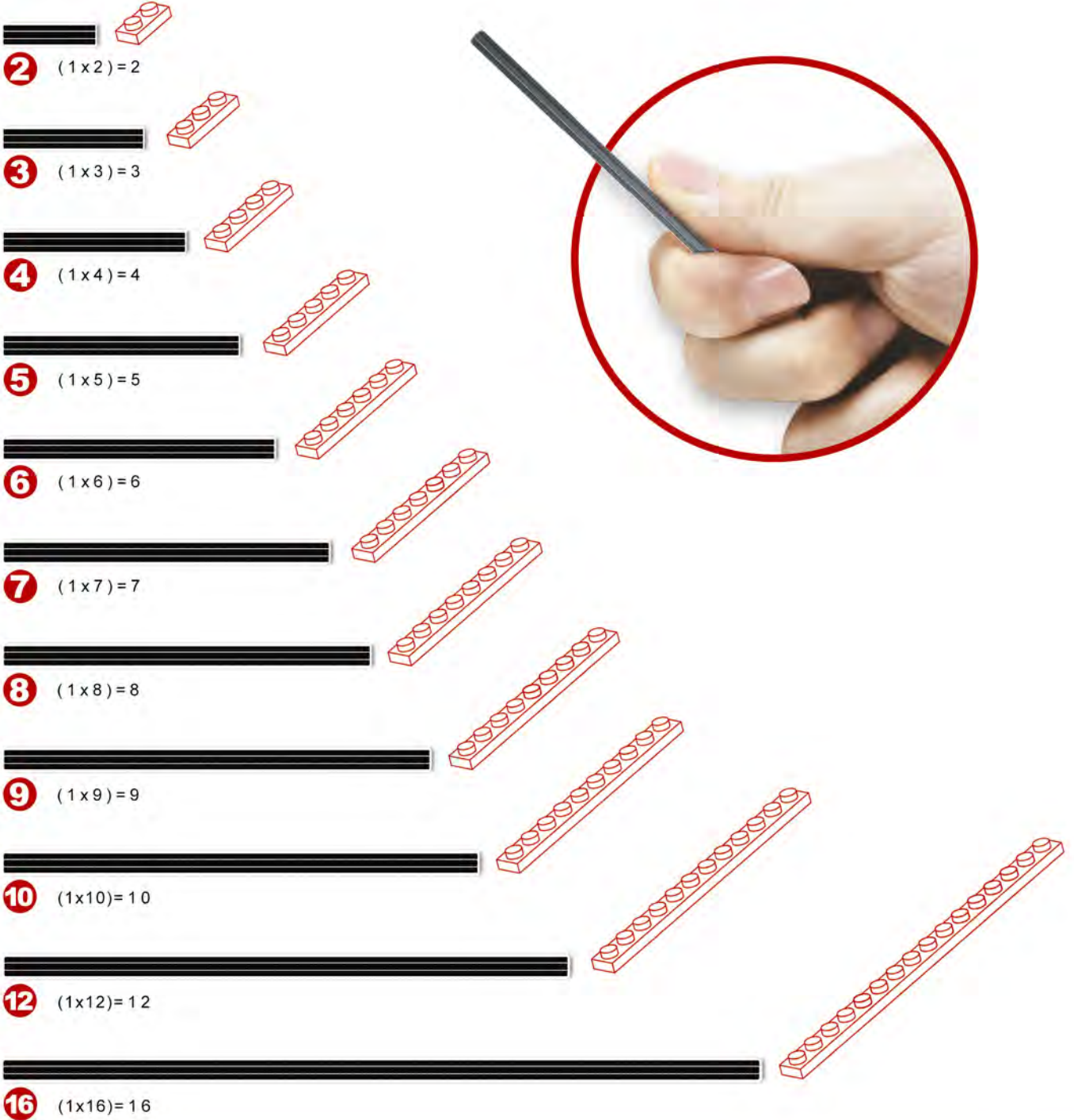

PARTS LIST

配件清单

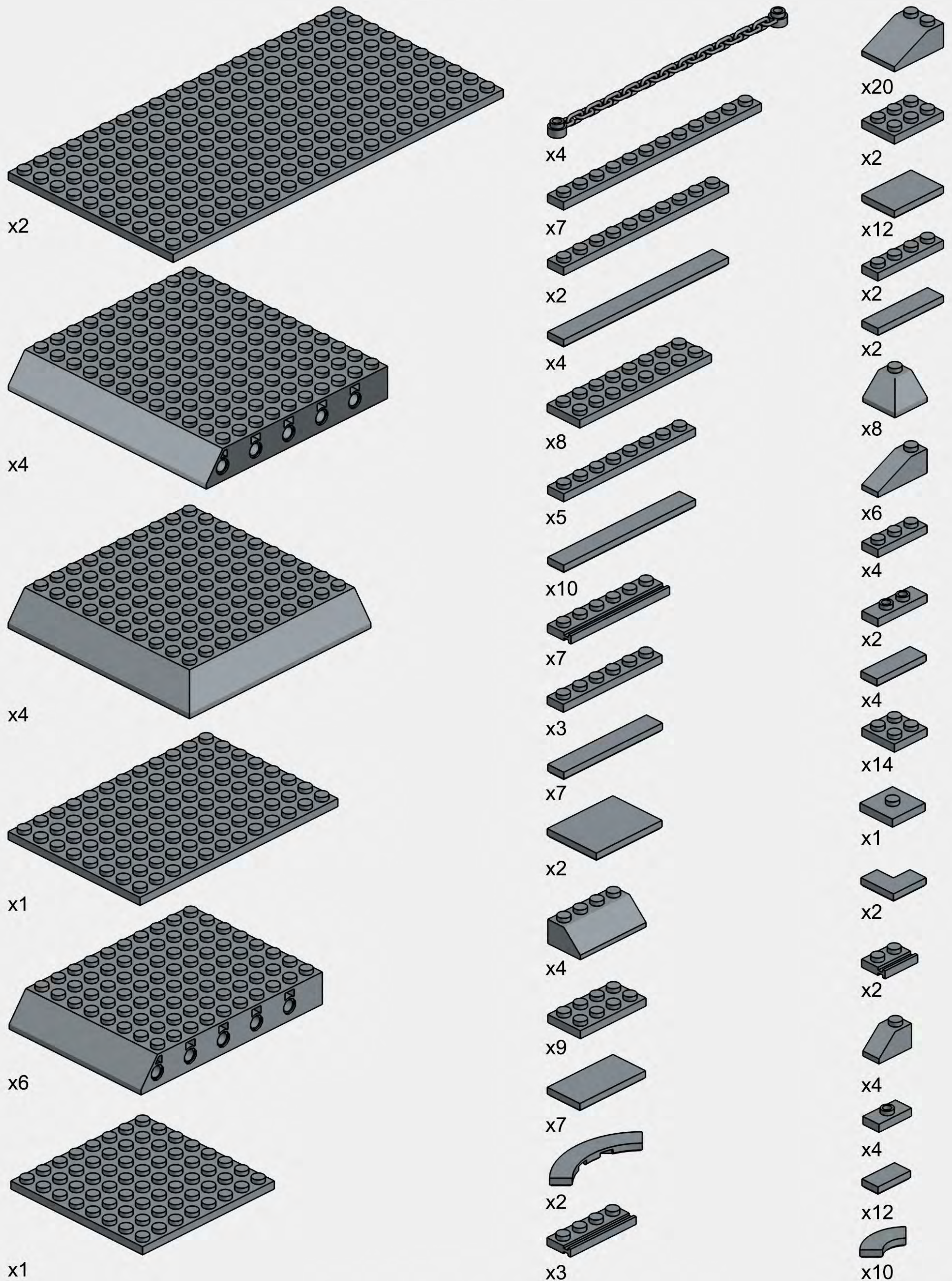

产品有增补件请以实物为准

If product has additional parts, please in kind prevail.

PARTS LIST

配件清单



x2

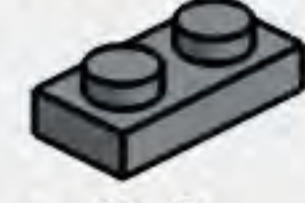

x24



x3



x6



x8



x4



x10



x8



x18



x12



x2



x2



x9



x4

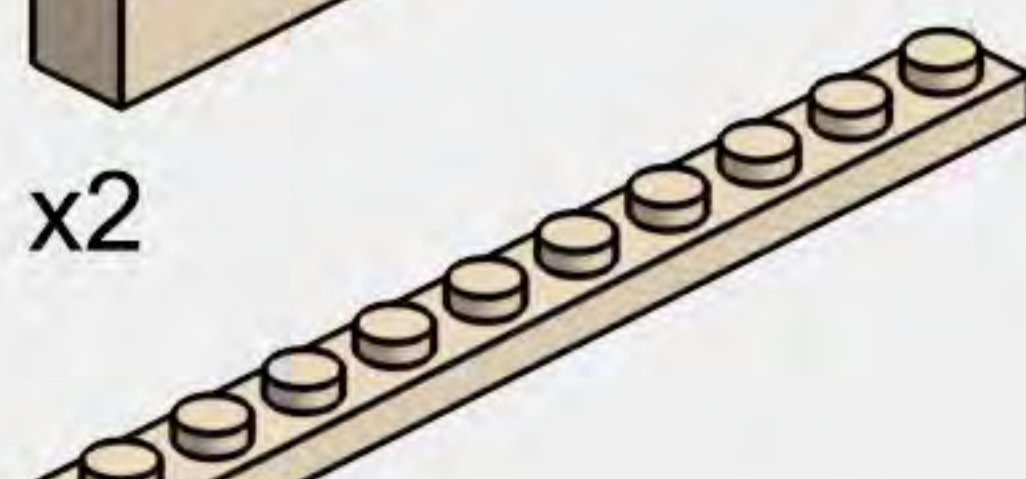

x2

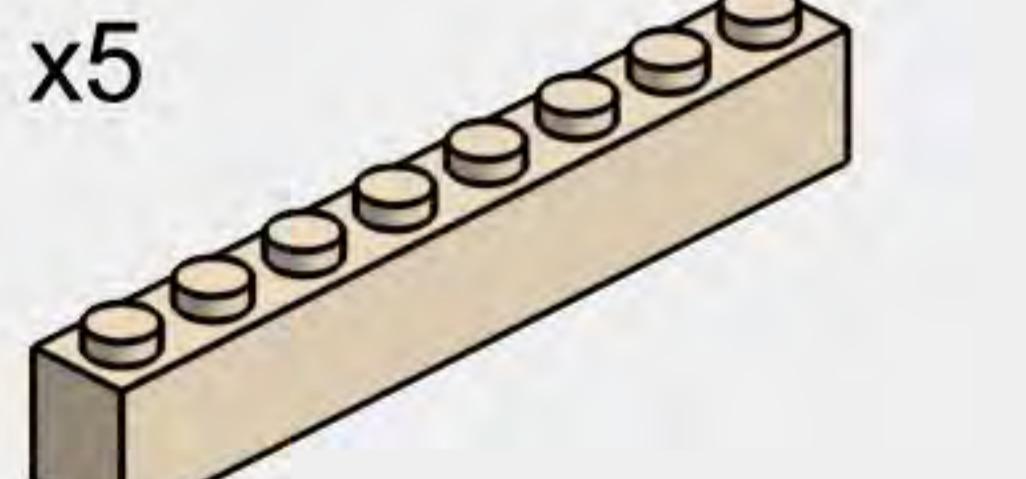

x5



x8

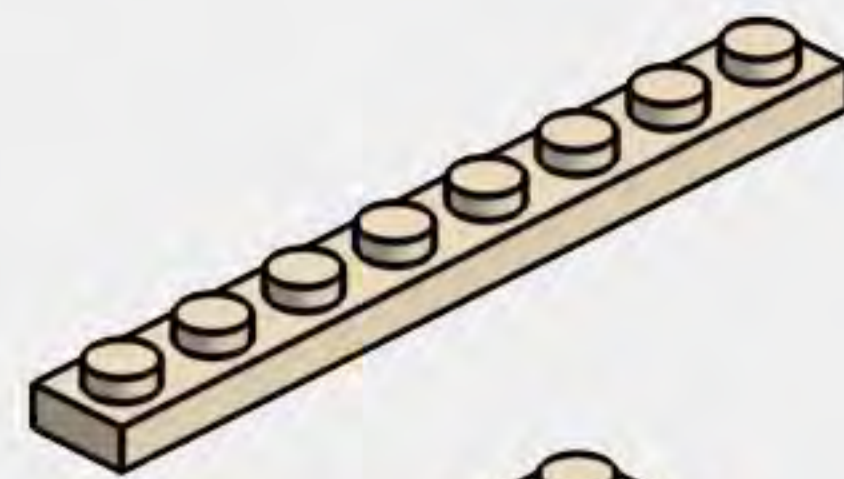

x5

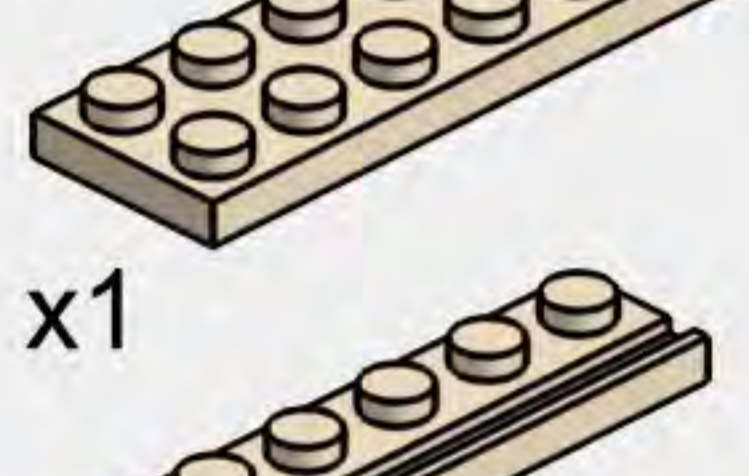

x1



x5



x14

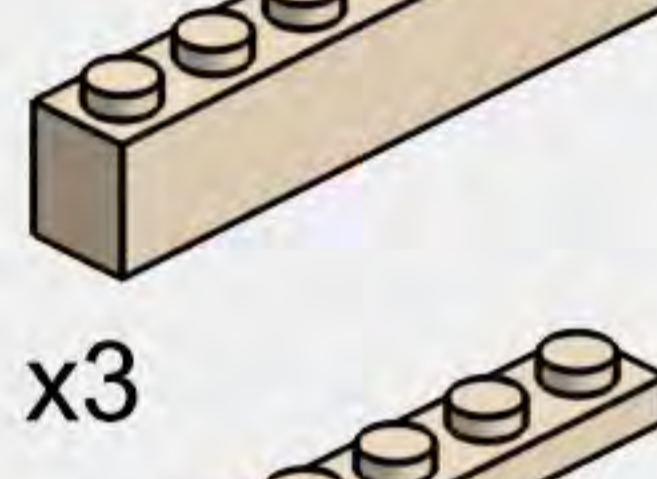

x3



x5

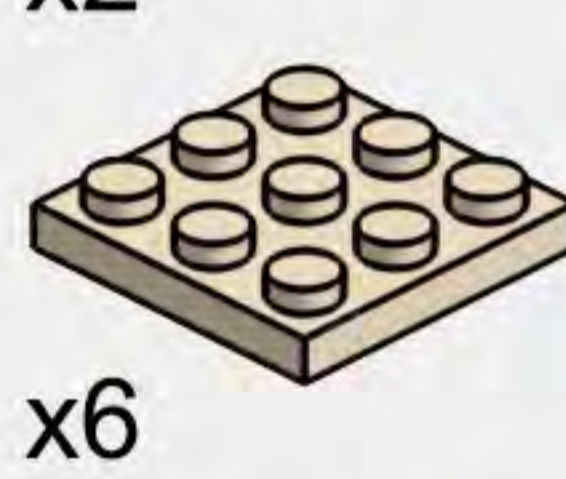

x2



x6



x4



x15

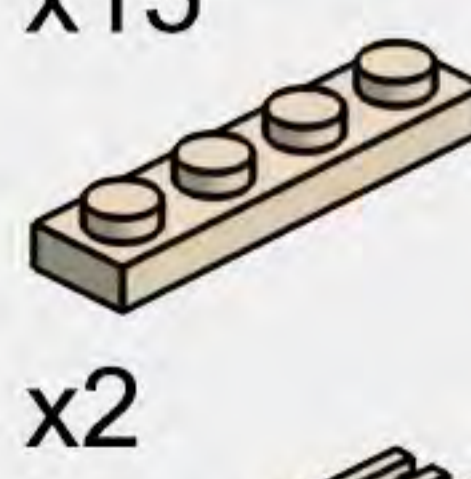

x2



x16

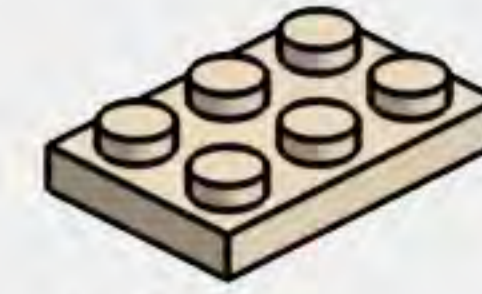

x4

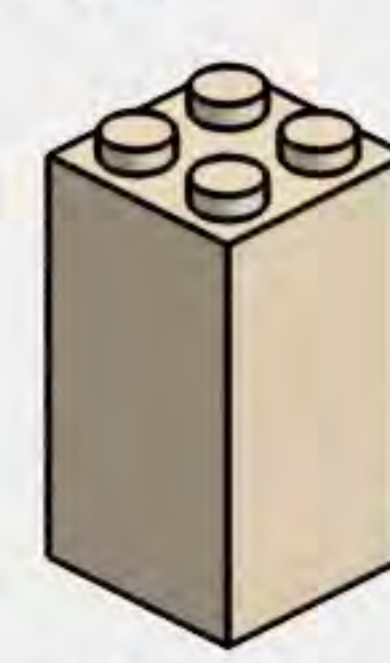

x2

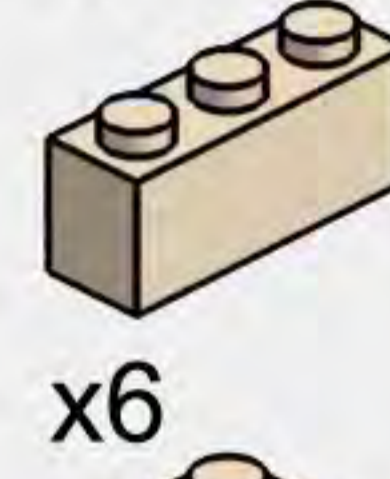

x6



x2

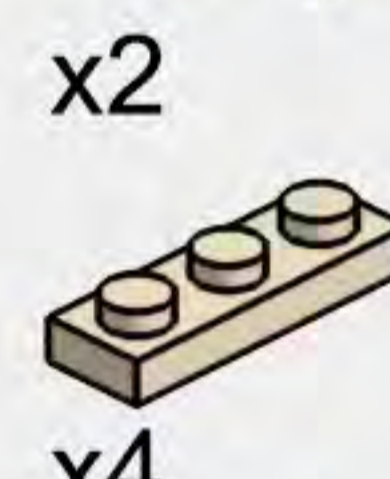

x4

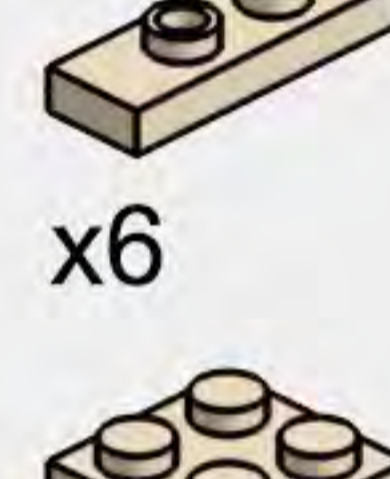

x6



x2



x4



x6

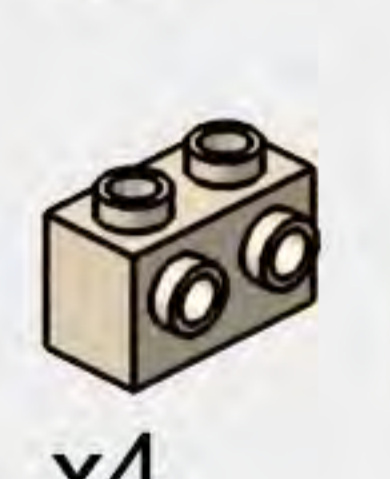

x8



x4



x14

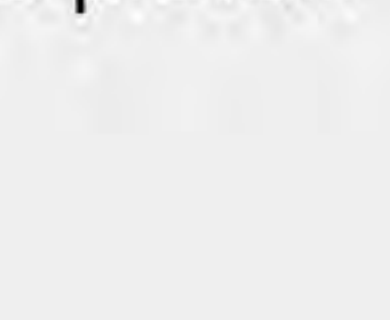

x26

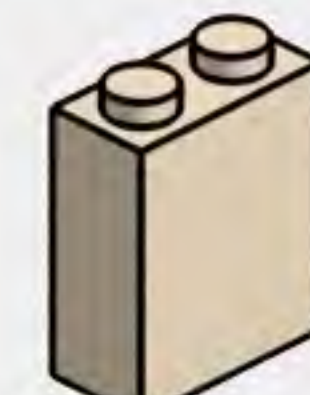

x26



x16



x32



x9



x16



x22

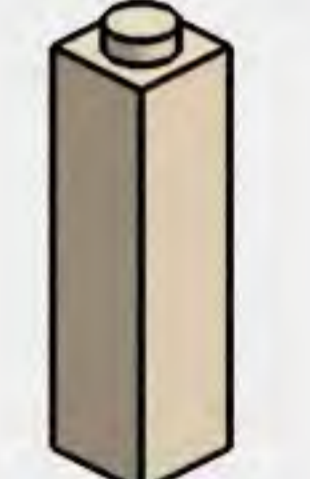

x20

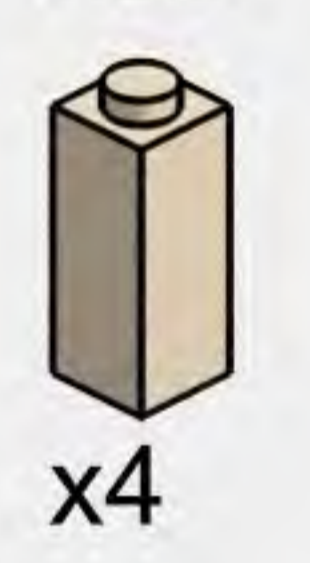

x4

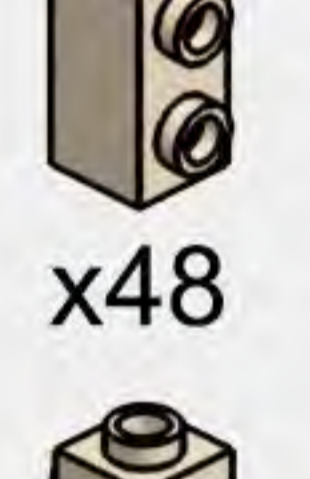

x48



x16



x40

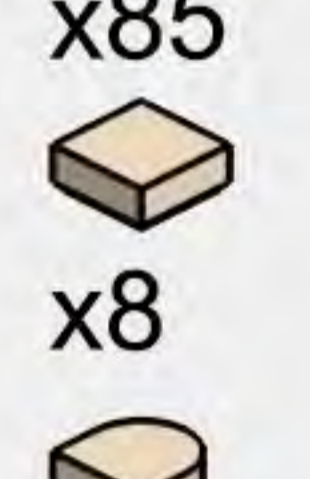

x79



x85



x8

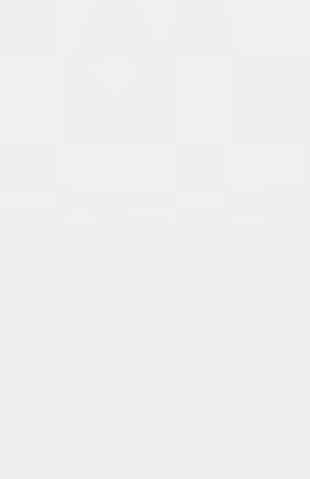

x22

x18

x22

x2



产品有增补件请以实物为准

If product has additional parts, please in kind prevail.

PARTS LIST

配件清单

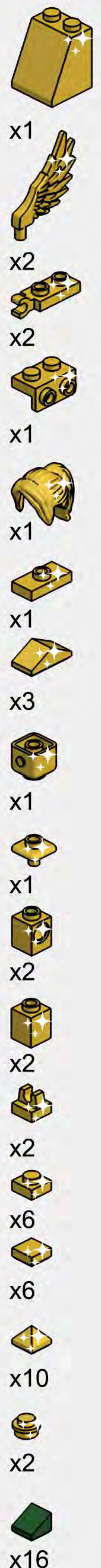
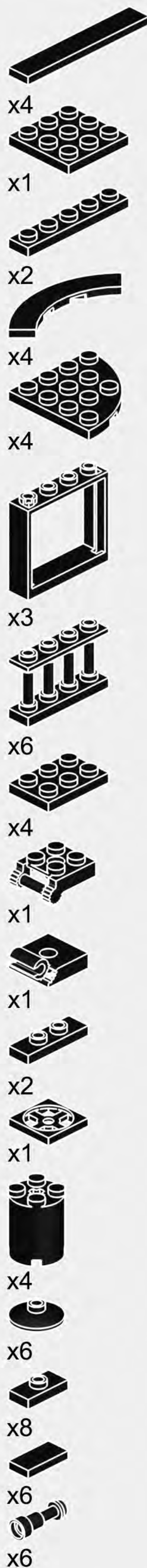
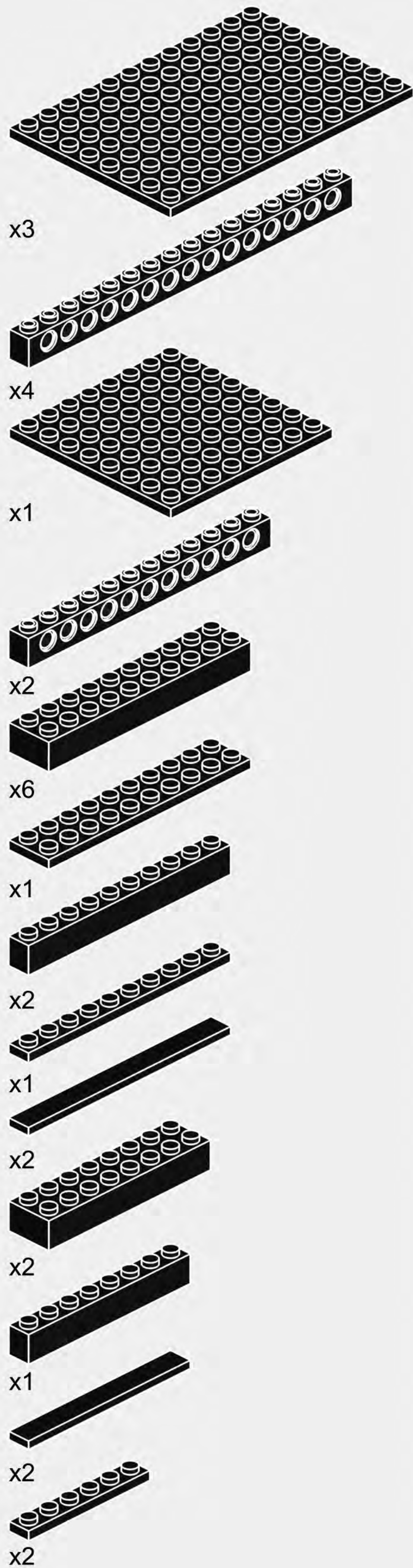

产品有增补件请以实物为准
 If product has additional parts, please in kind prevail.

PARTS LIST

配件清单

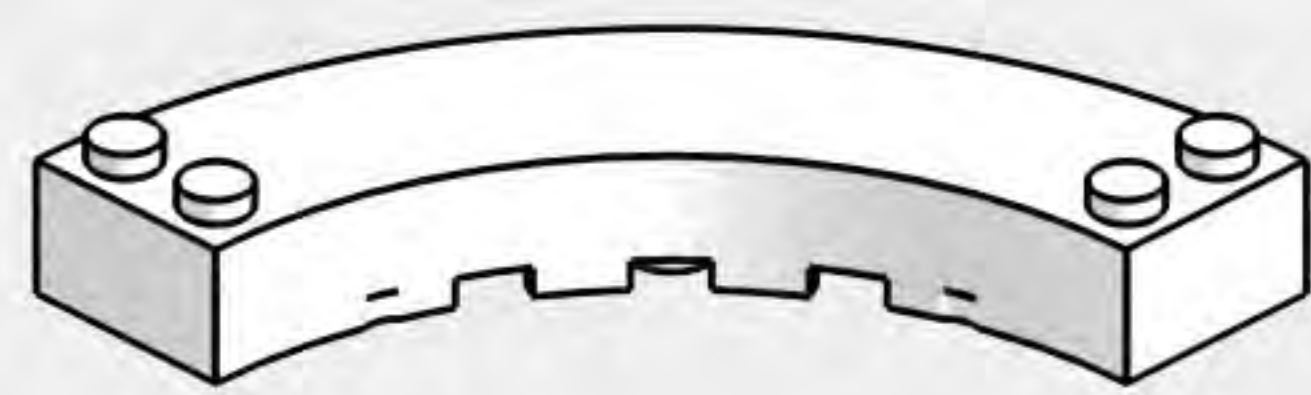

x4

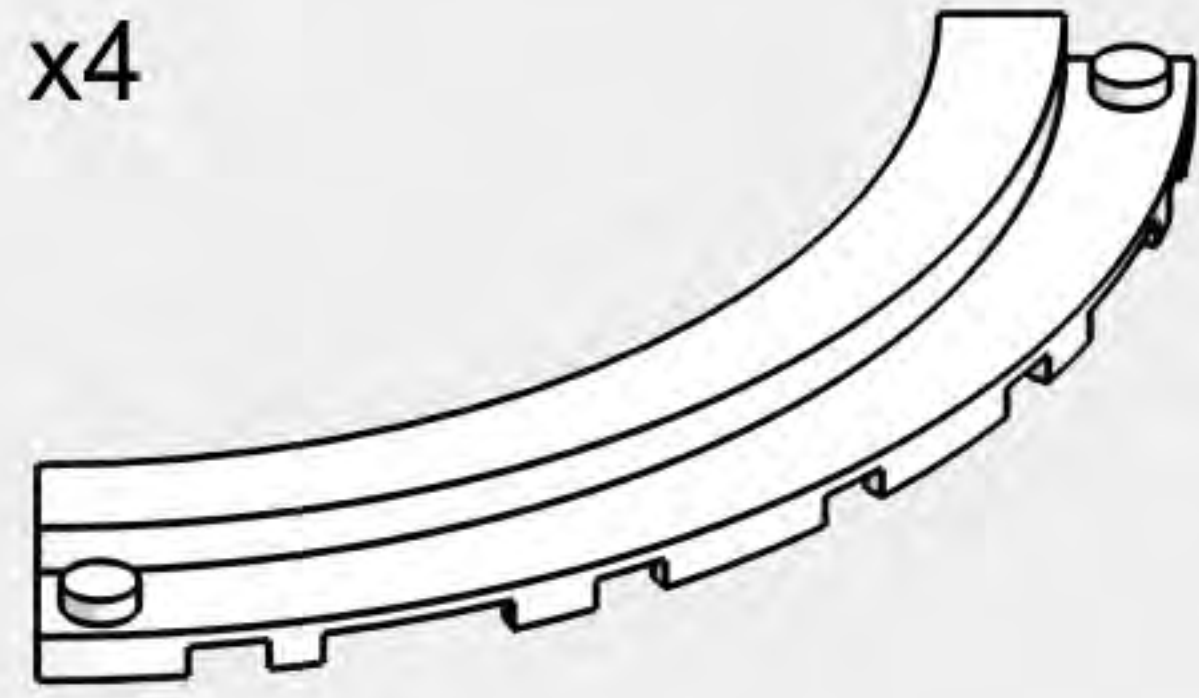

x4

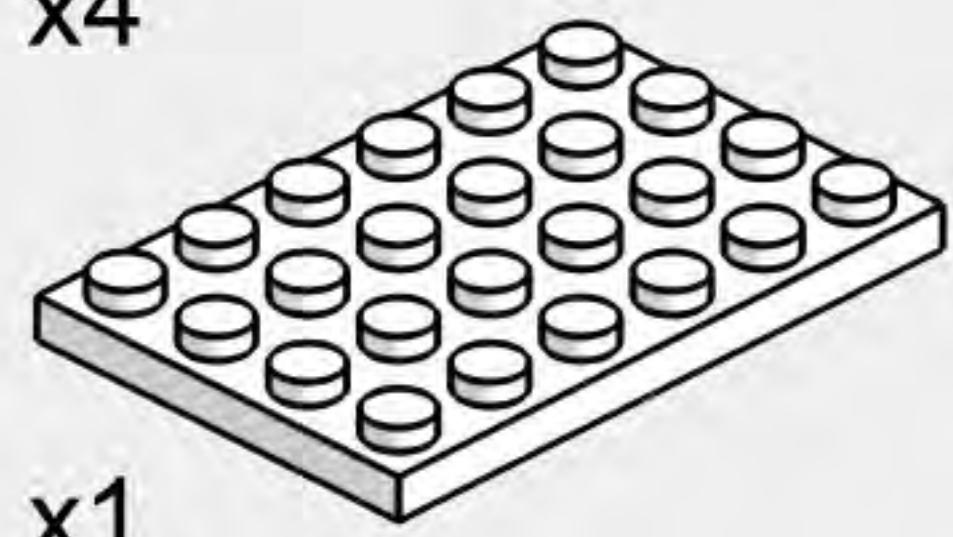

x1

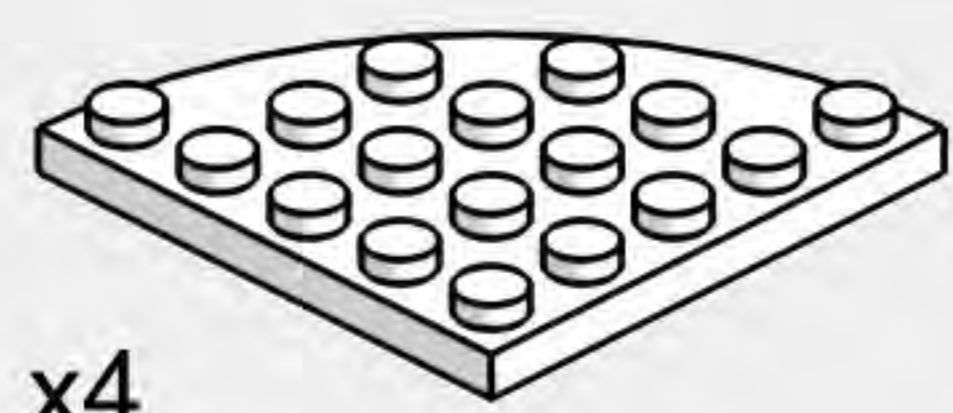

x4

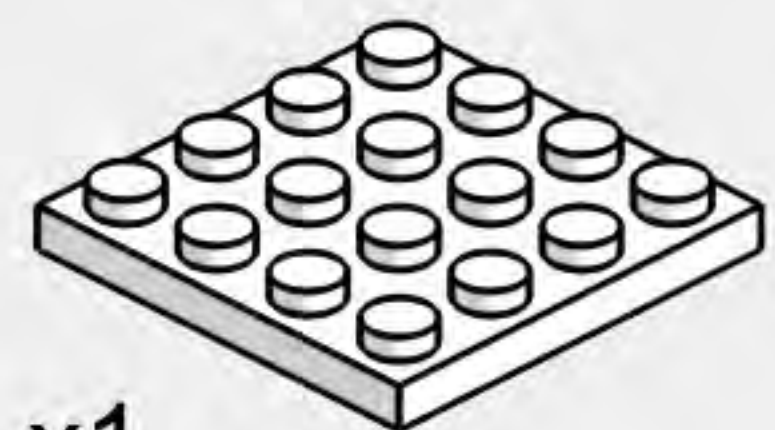

x1



x4



x1

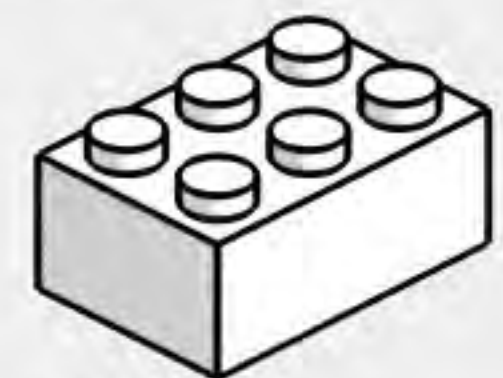

x3

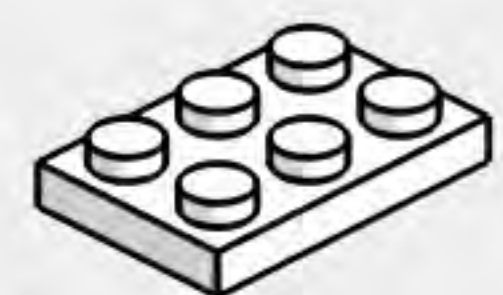

x1

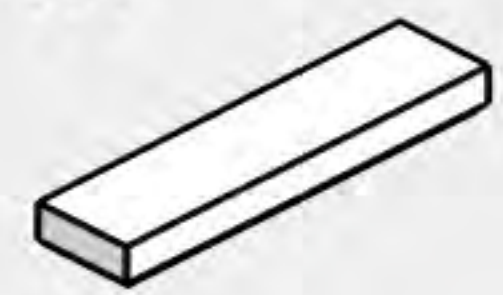

x7



x1

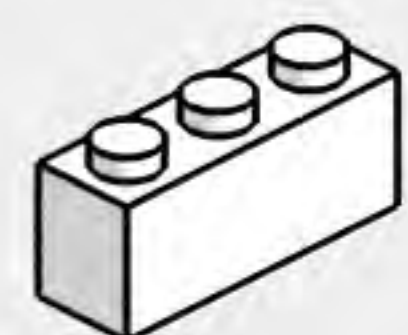

x3

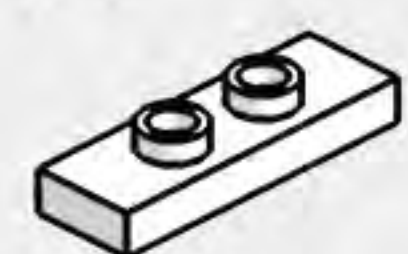

x7

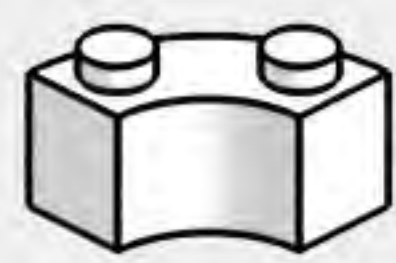

x16

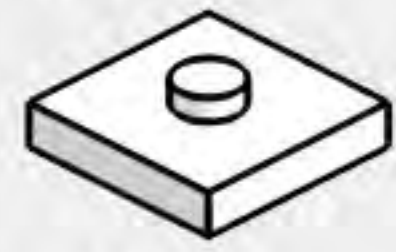

x6

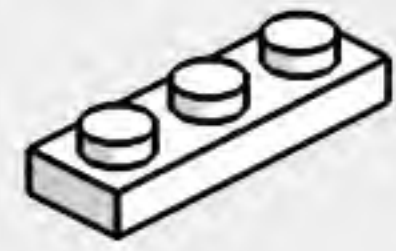

x1



x2



x2

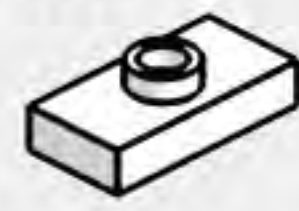

x8

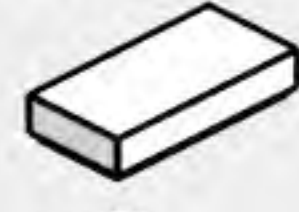

x6



x1



x4



x2

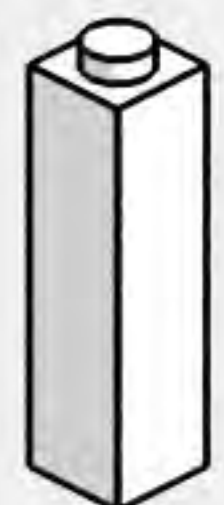

x6

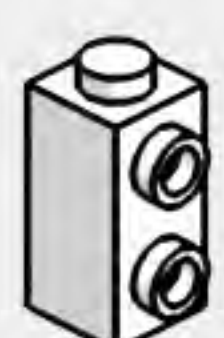

x4

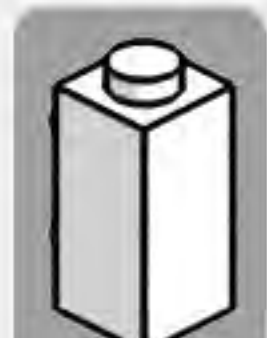

x12



x2



x12



x4



x1



x6



x2



x2



x2



x2



x2



x27



x49



x6



x50



x1

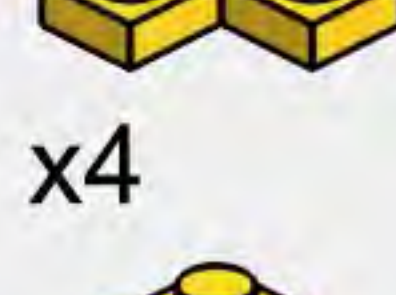

x4



x1



x5



x1



x1



x1

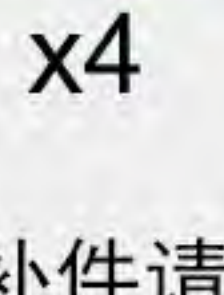

x4



x1

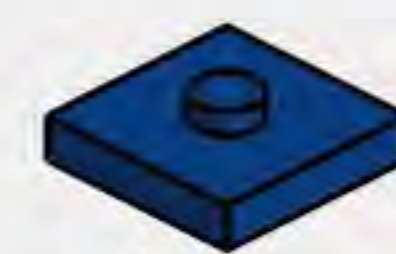

x4

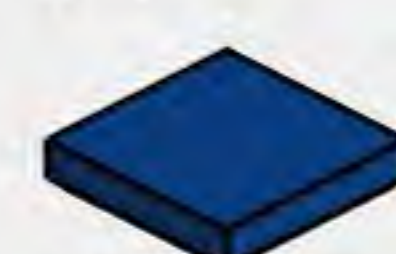

x8



x4



x4



x4



x1



x8



x5



x1



x1



x1



x1



x1



x4



x1



x10



x8



x4

产品有增补件请以实物为准

If product has additional parts, please in kind prevail.



271PCS

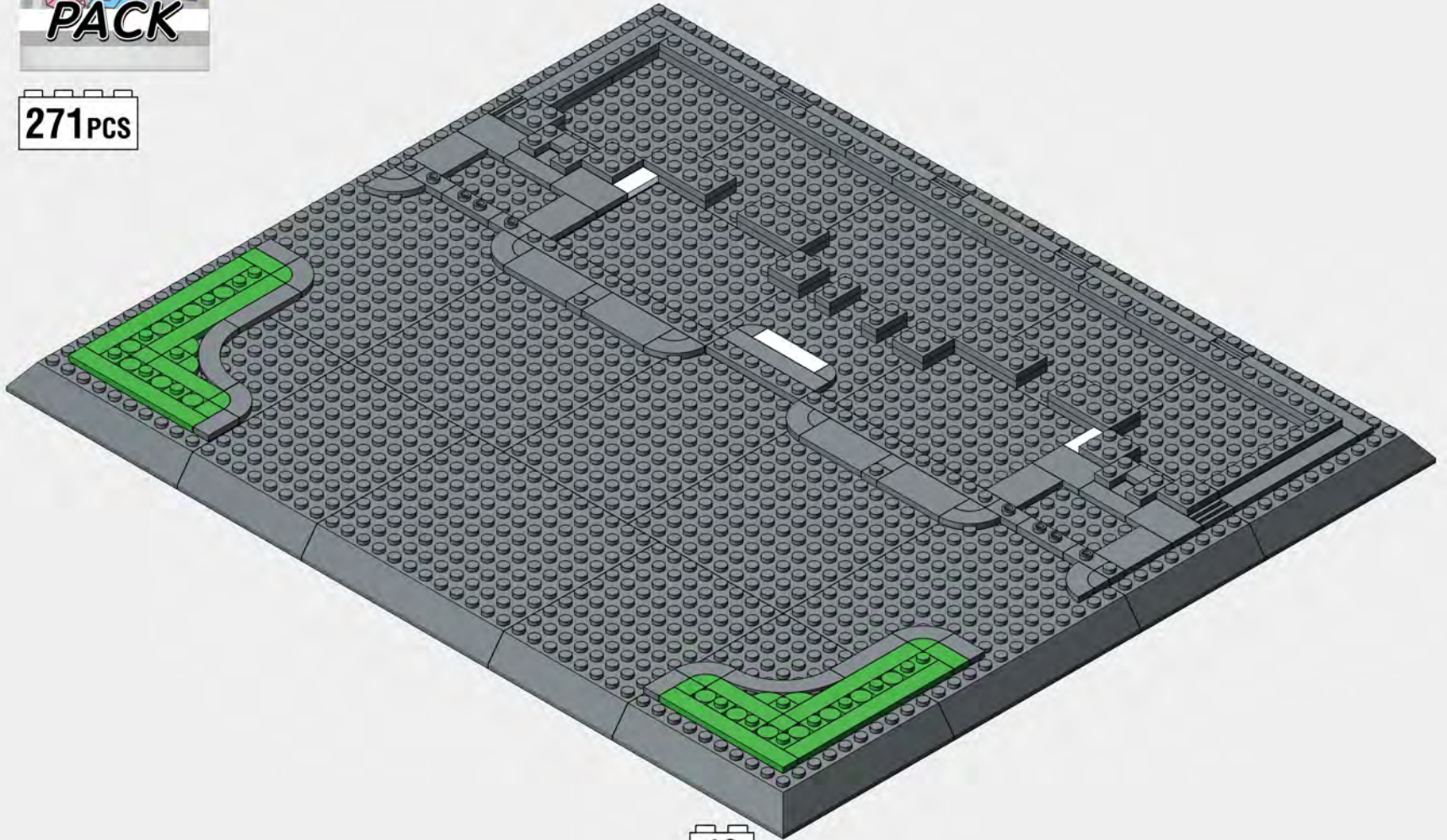

19

1-1

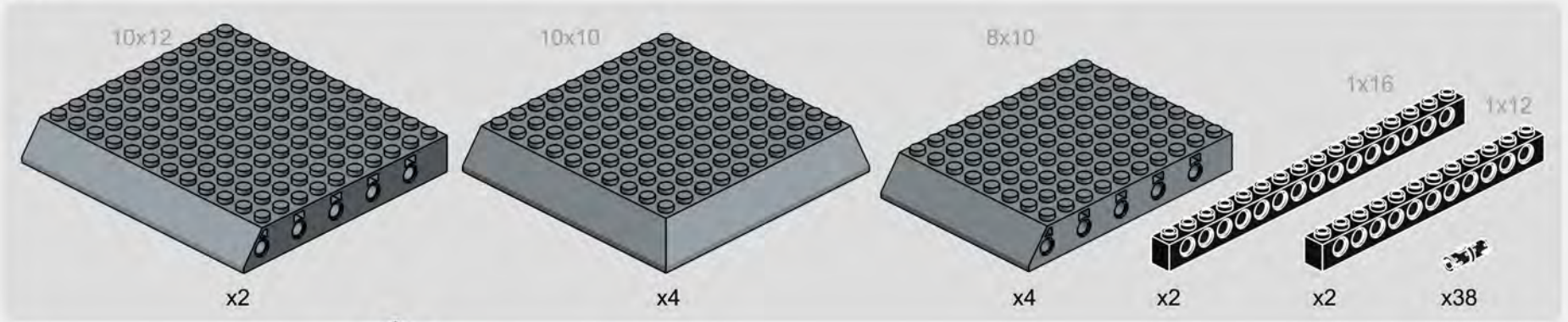

1

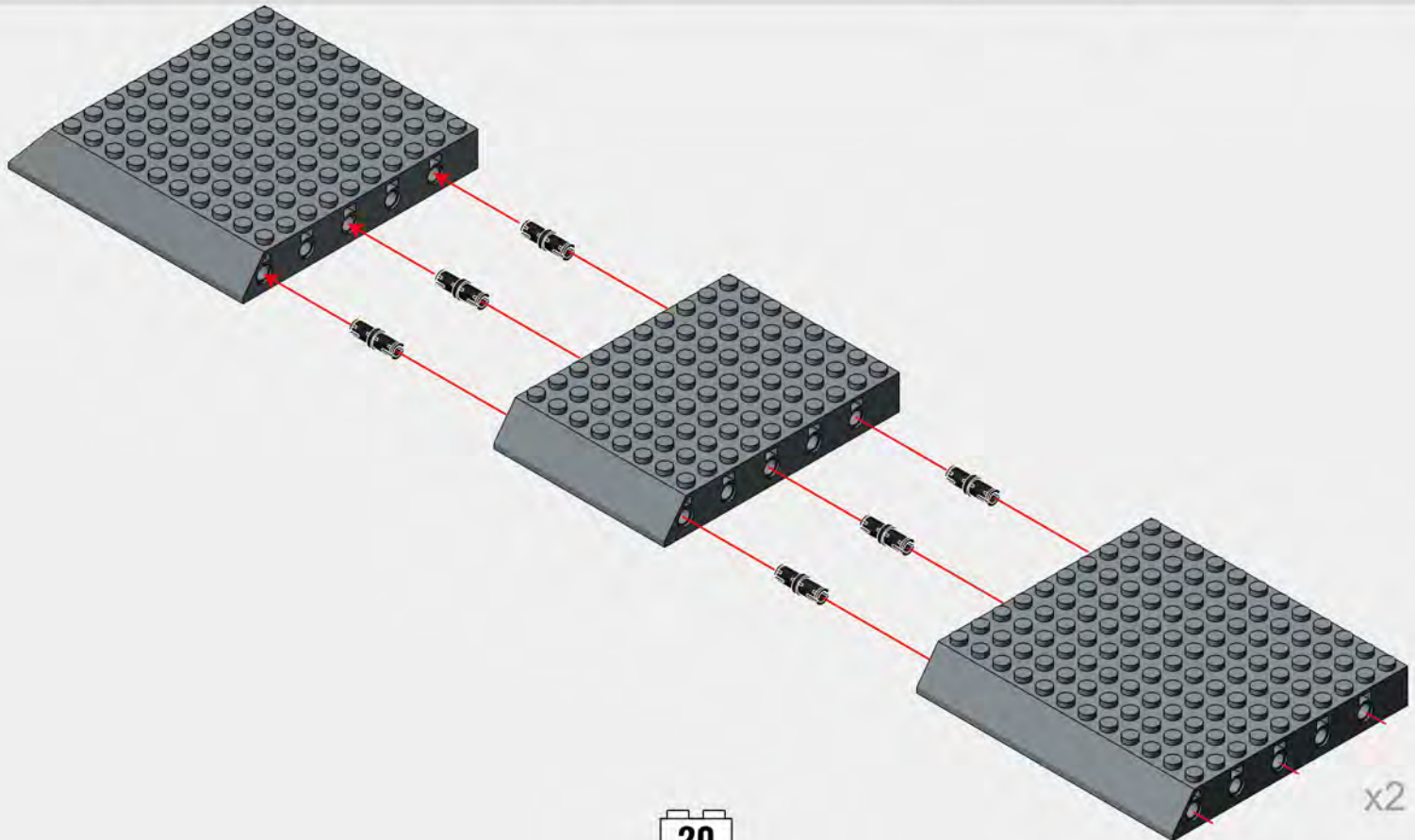

2

3

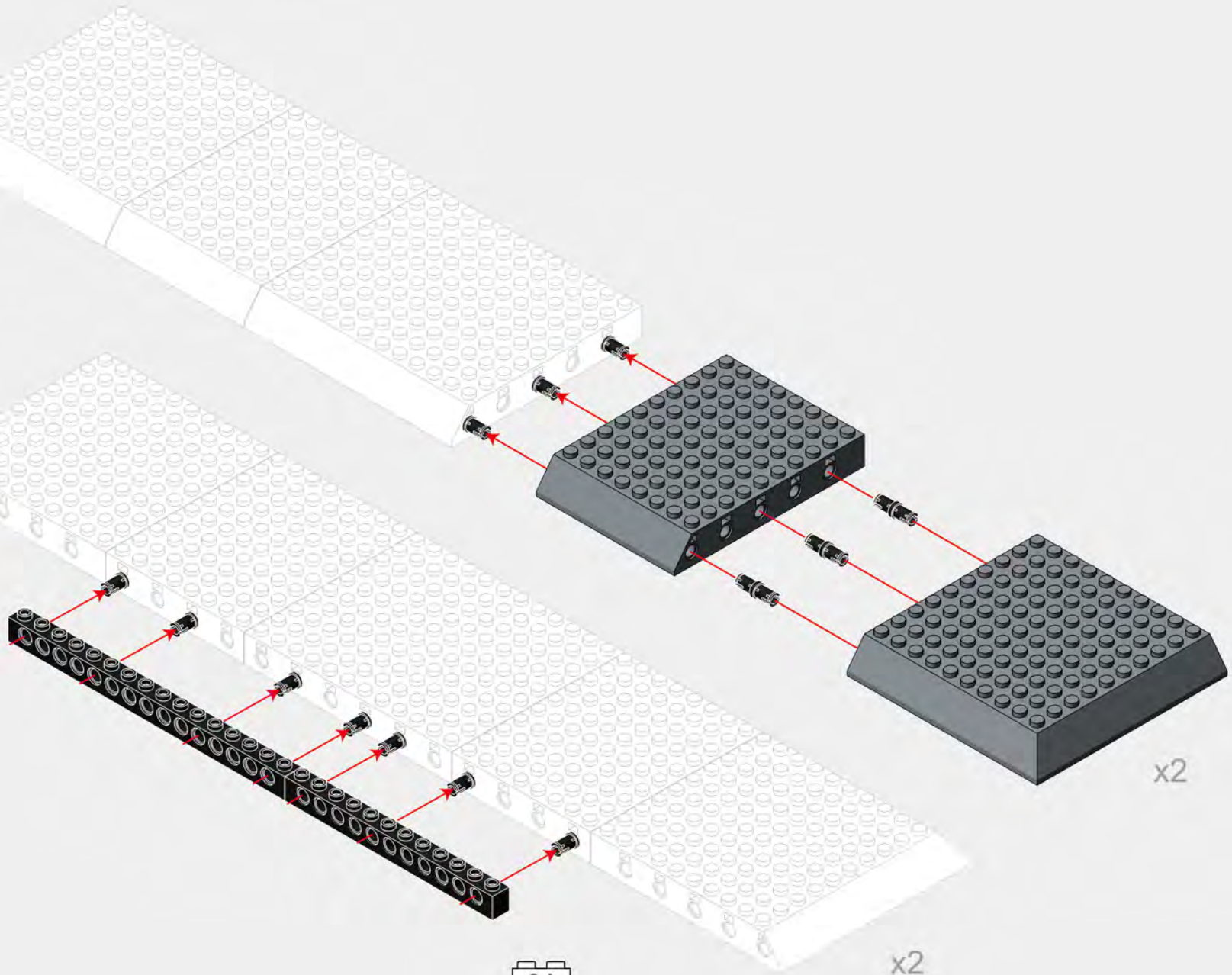

21

x2

x2

1-2

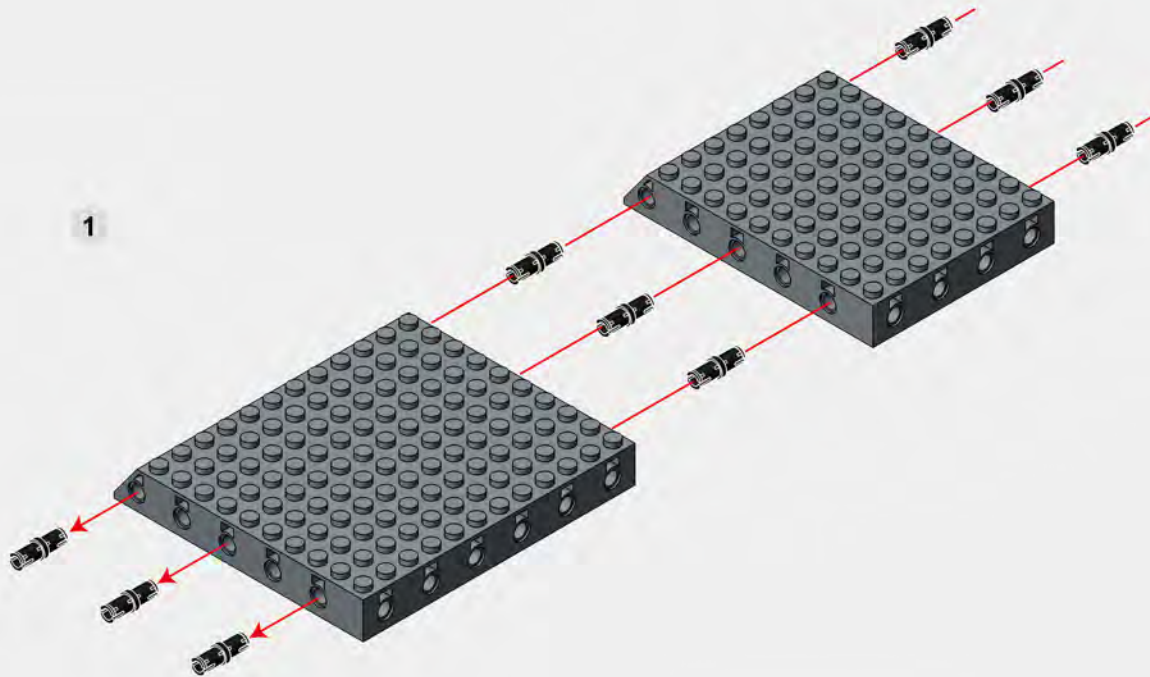
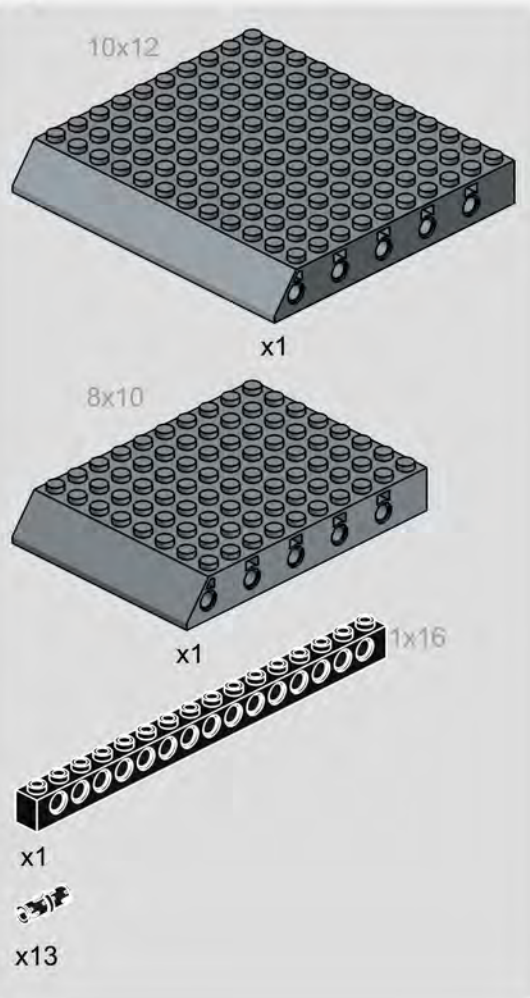

2

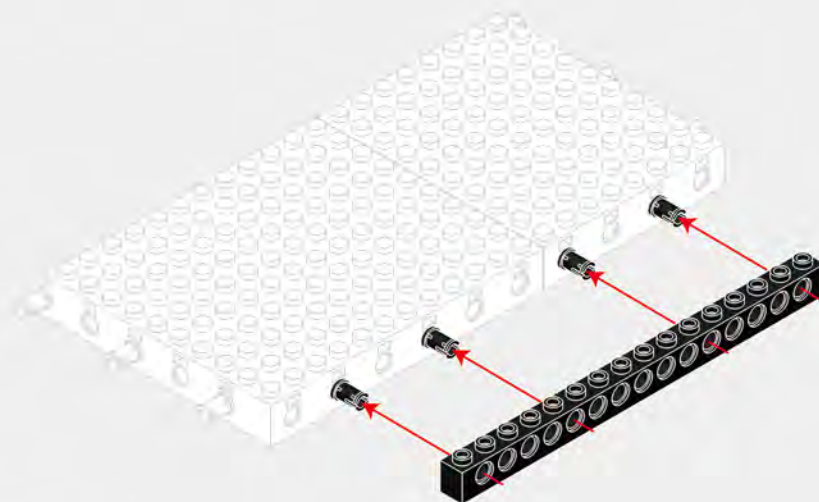

1-3

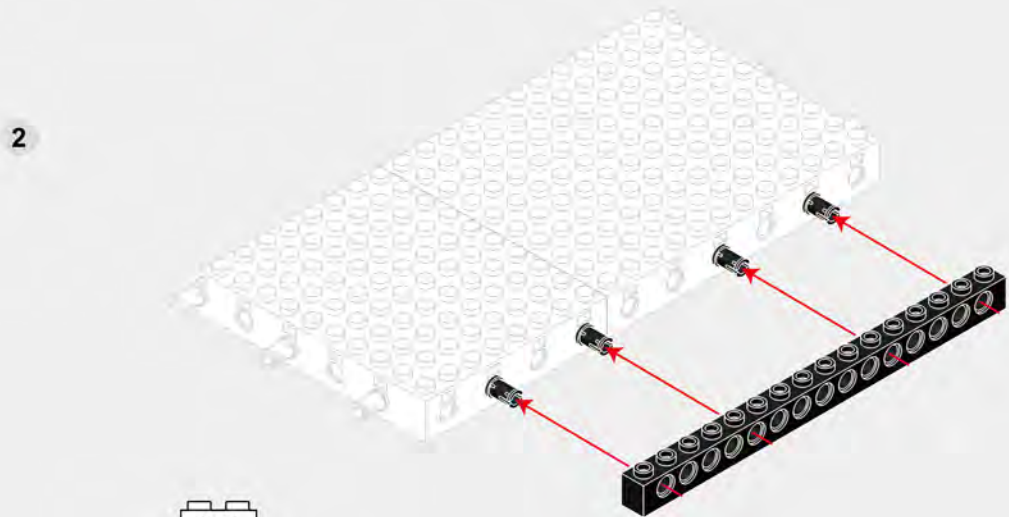
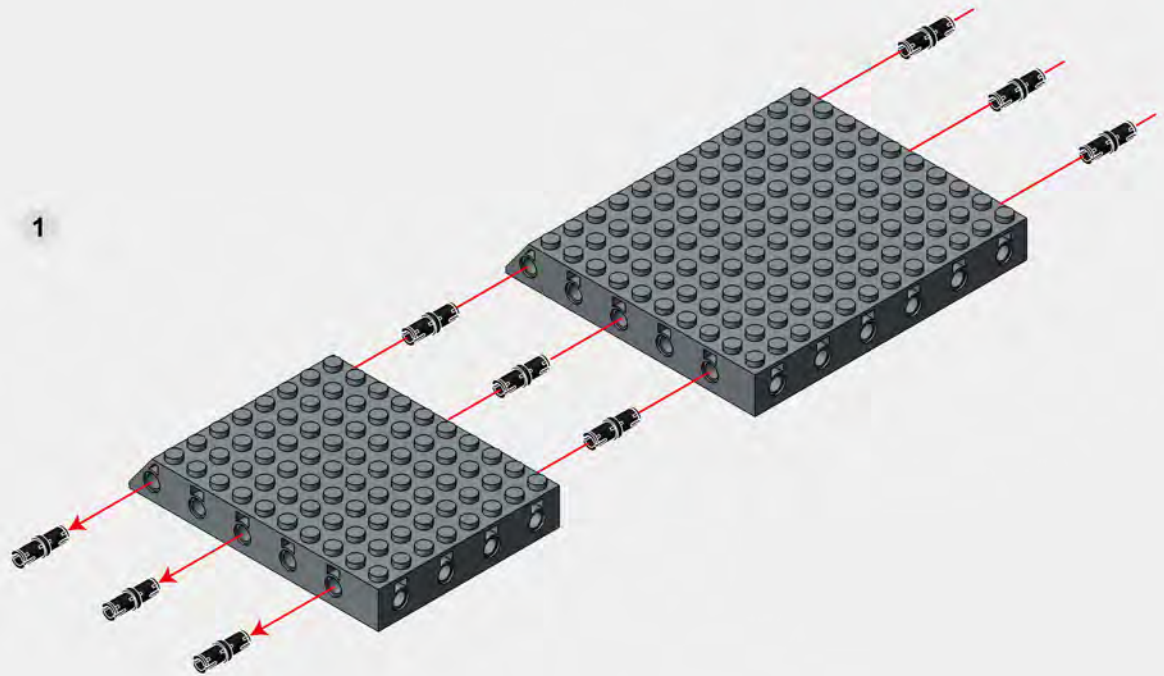
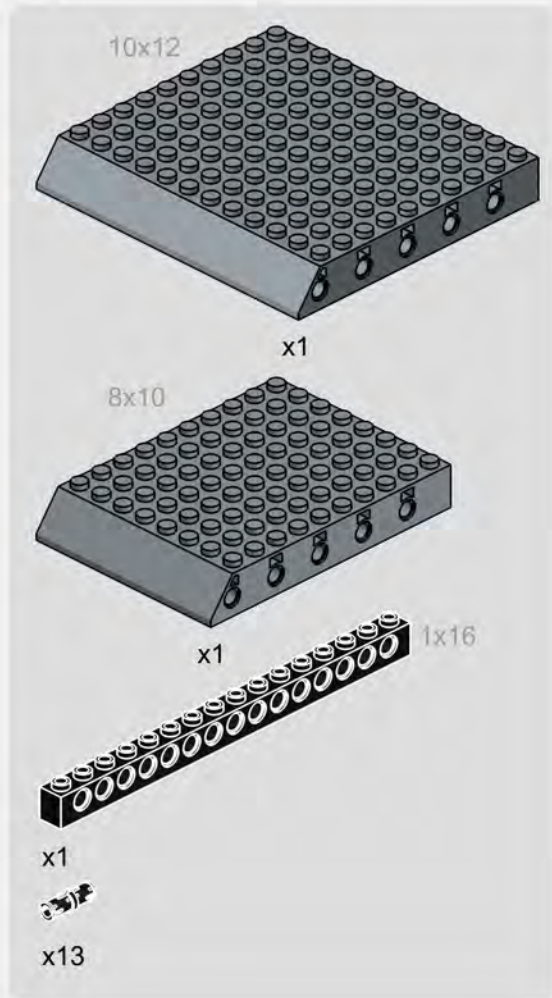

1-4

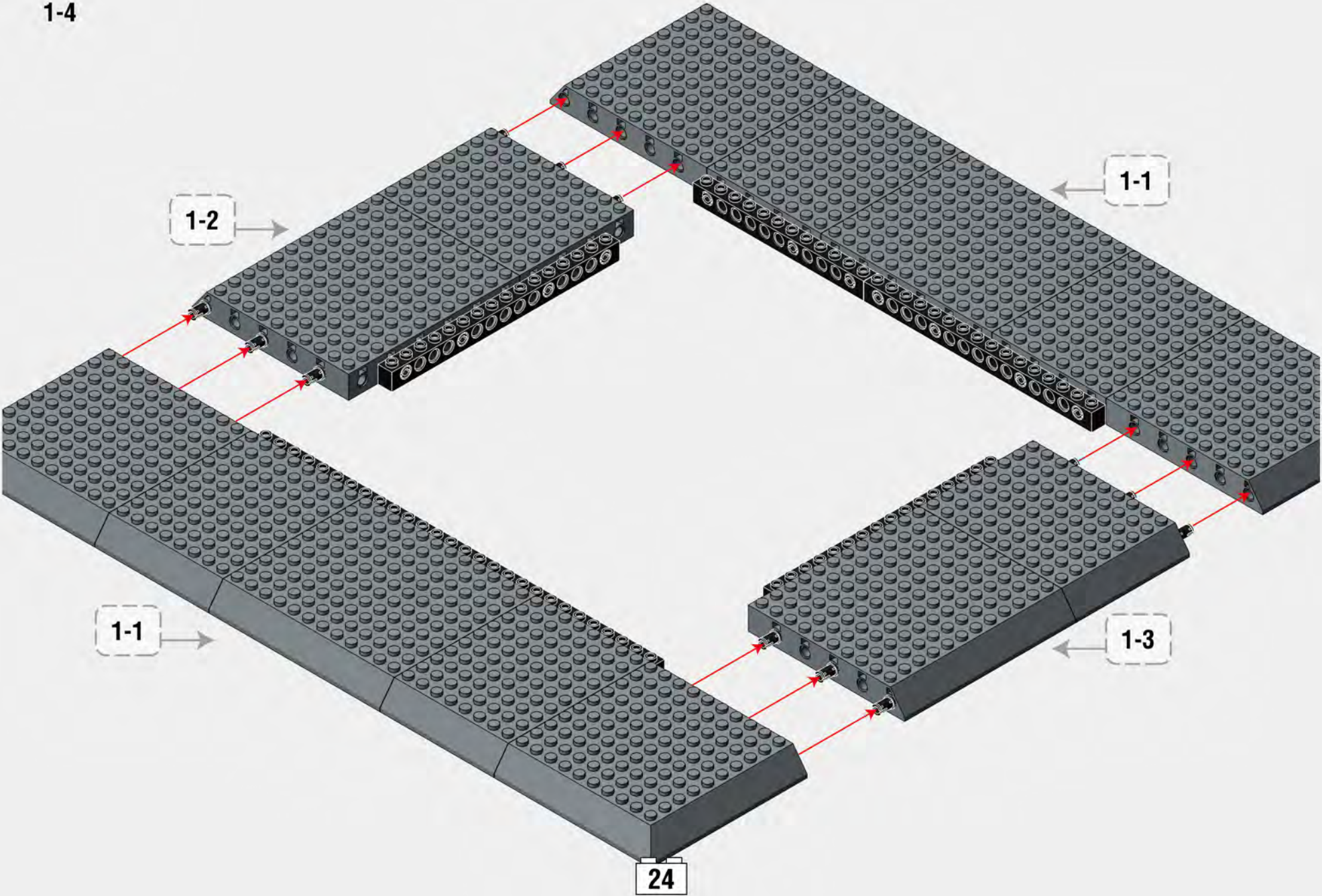

3

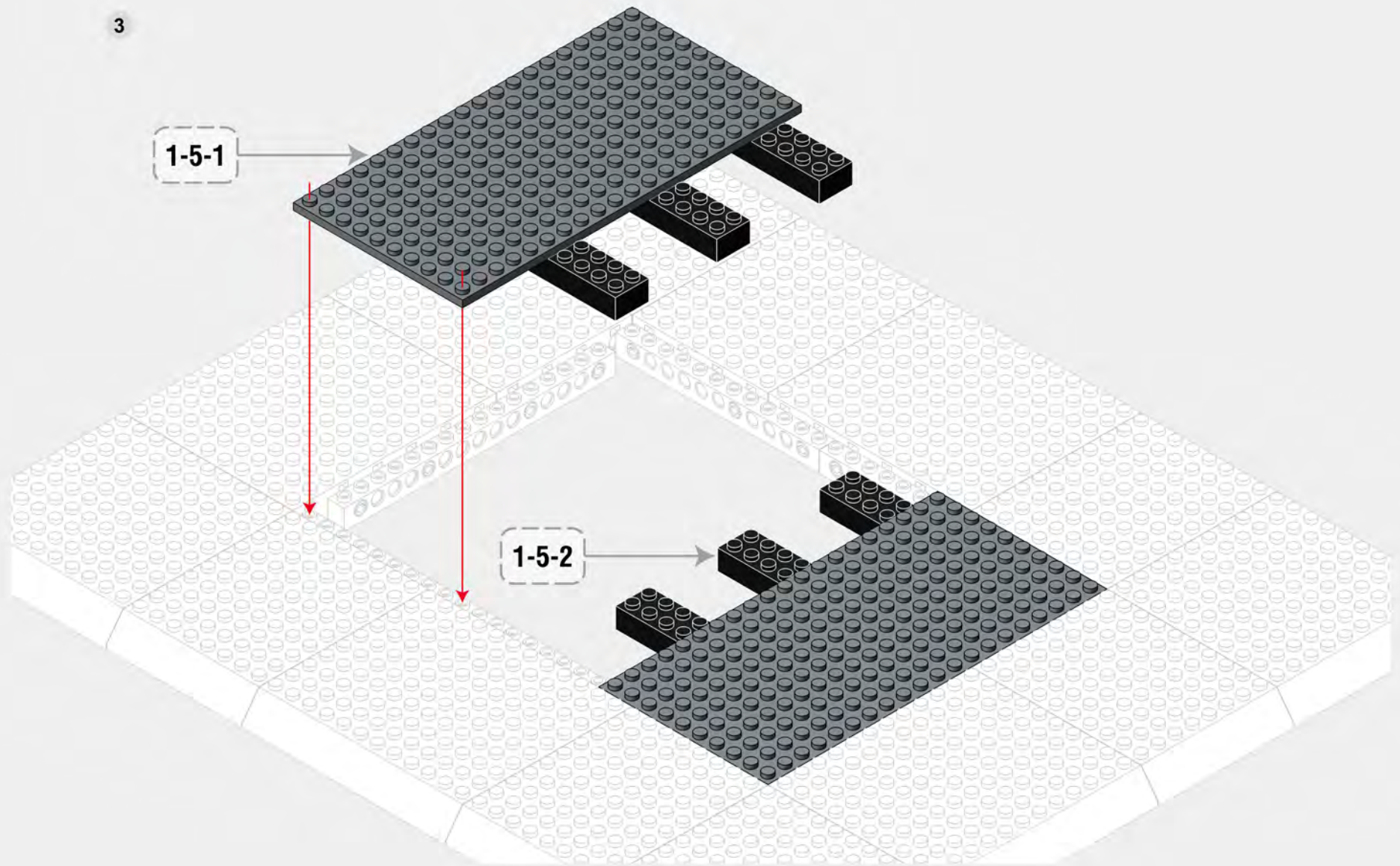

1-5-1

1-5-2

4

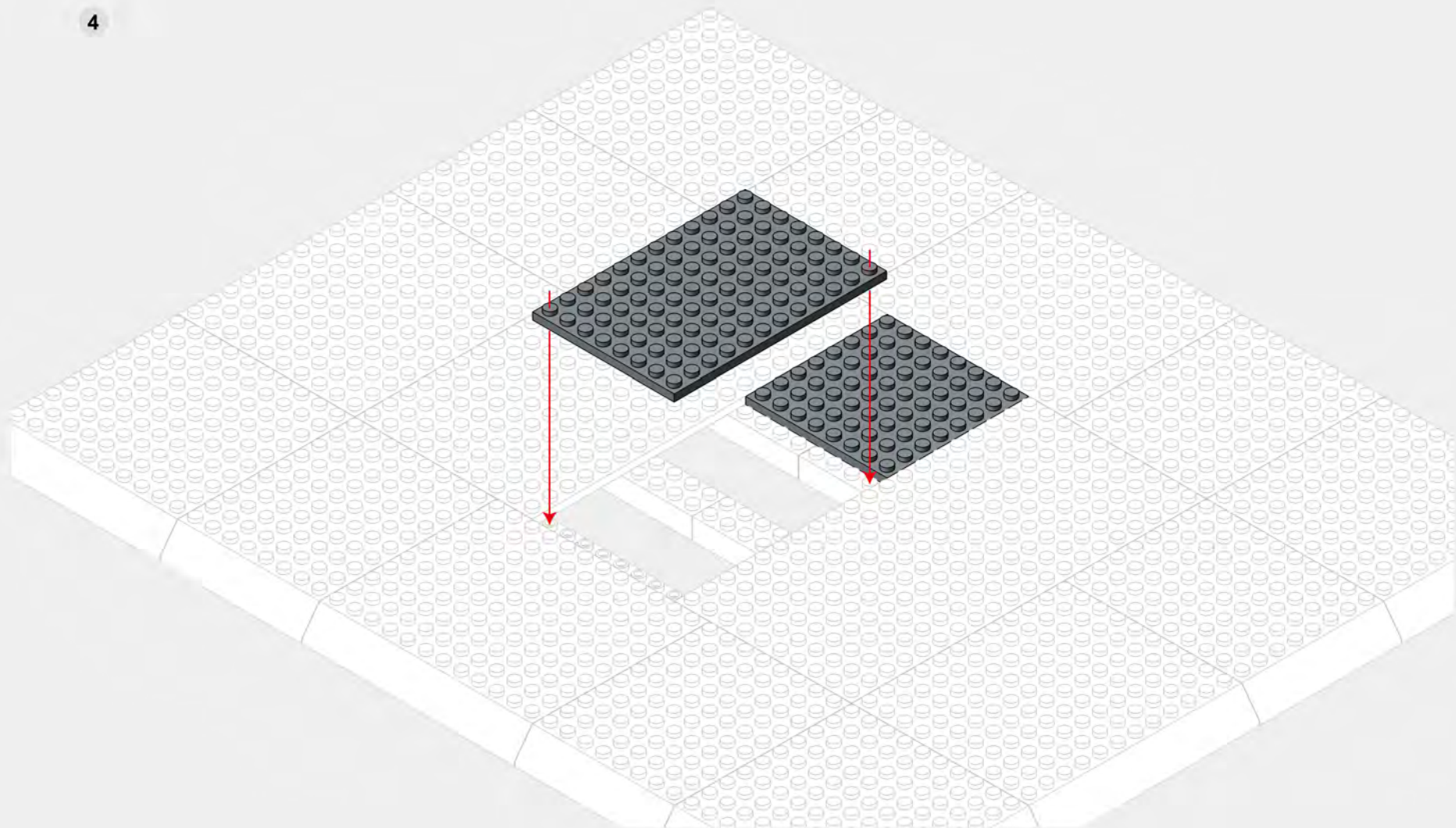

1-6

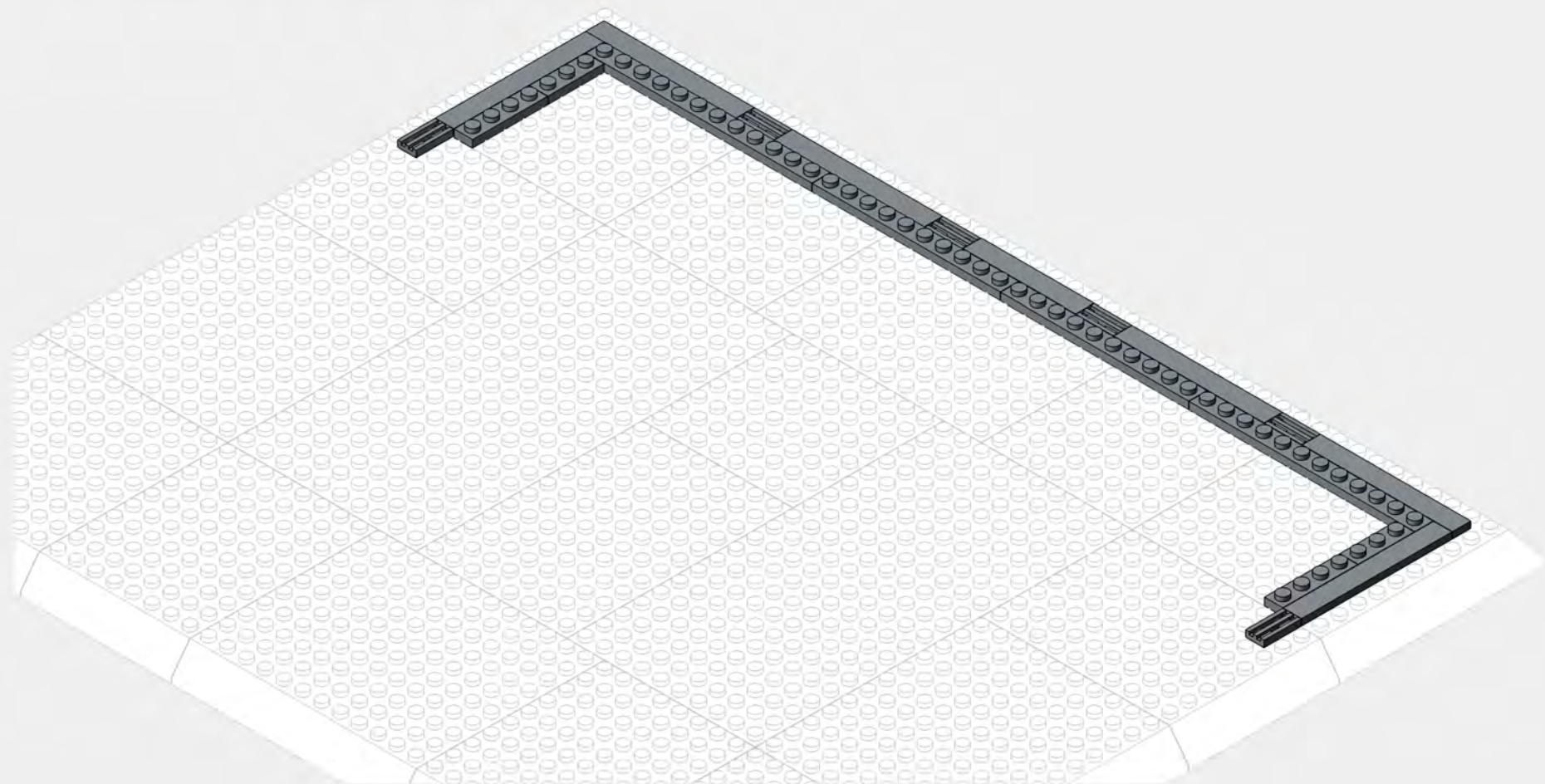
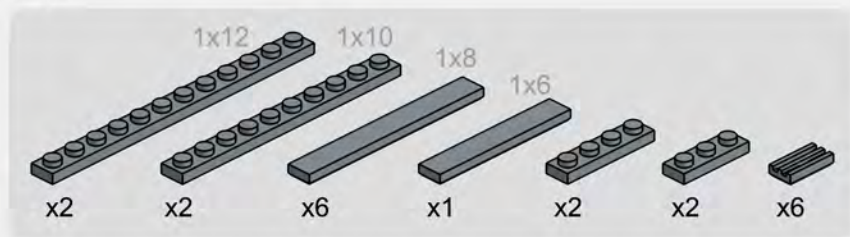

1-7

2x3

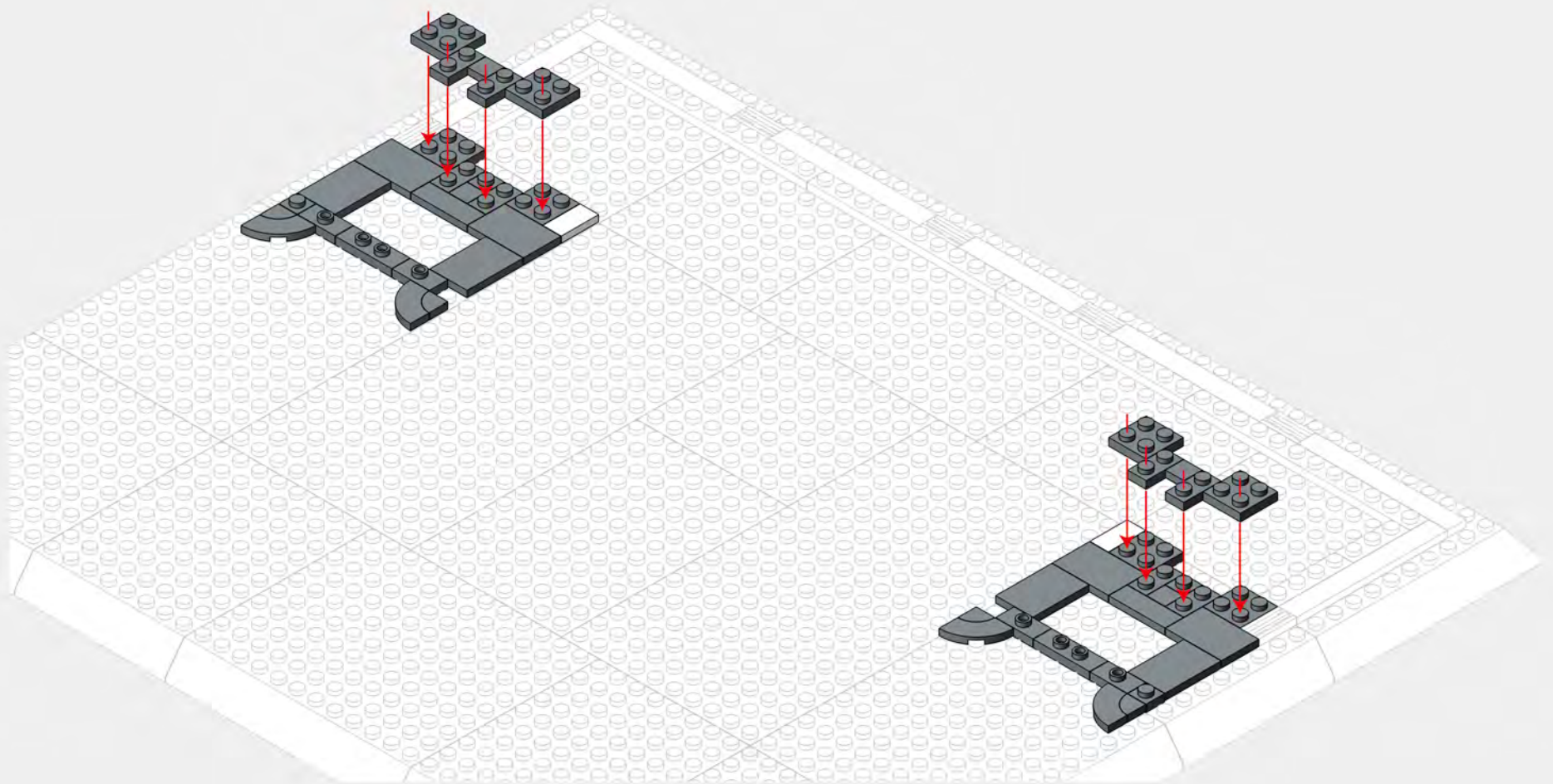
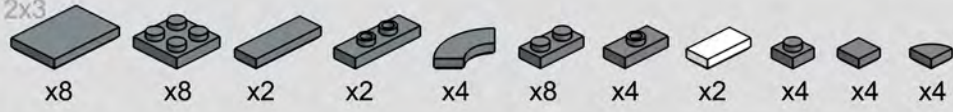

1-8

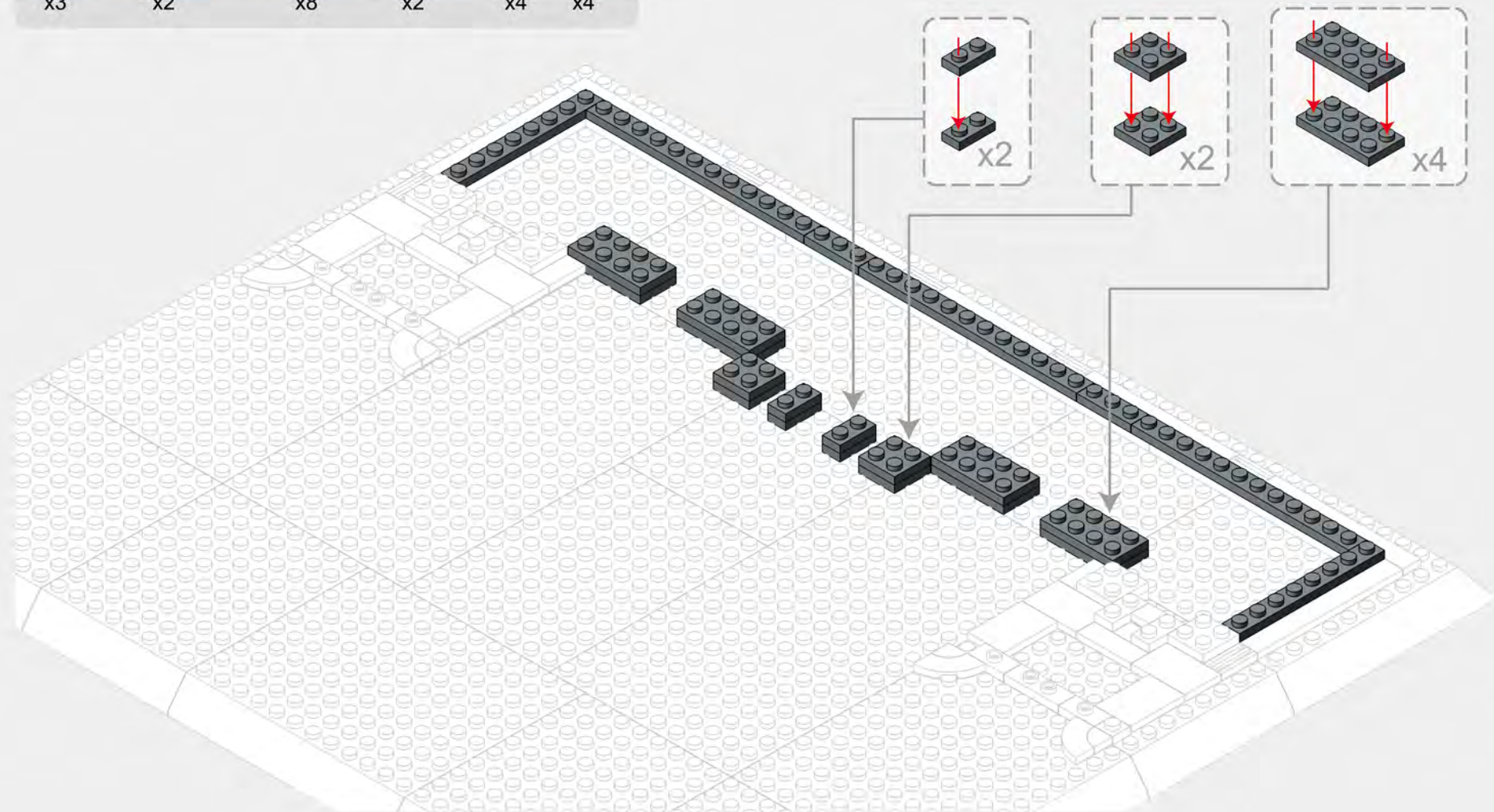
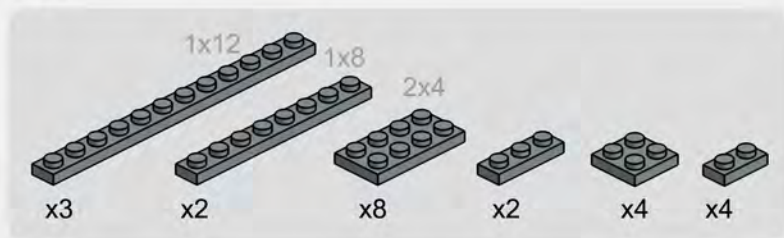

1-9

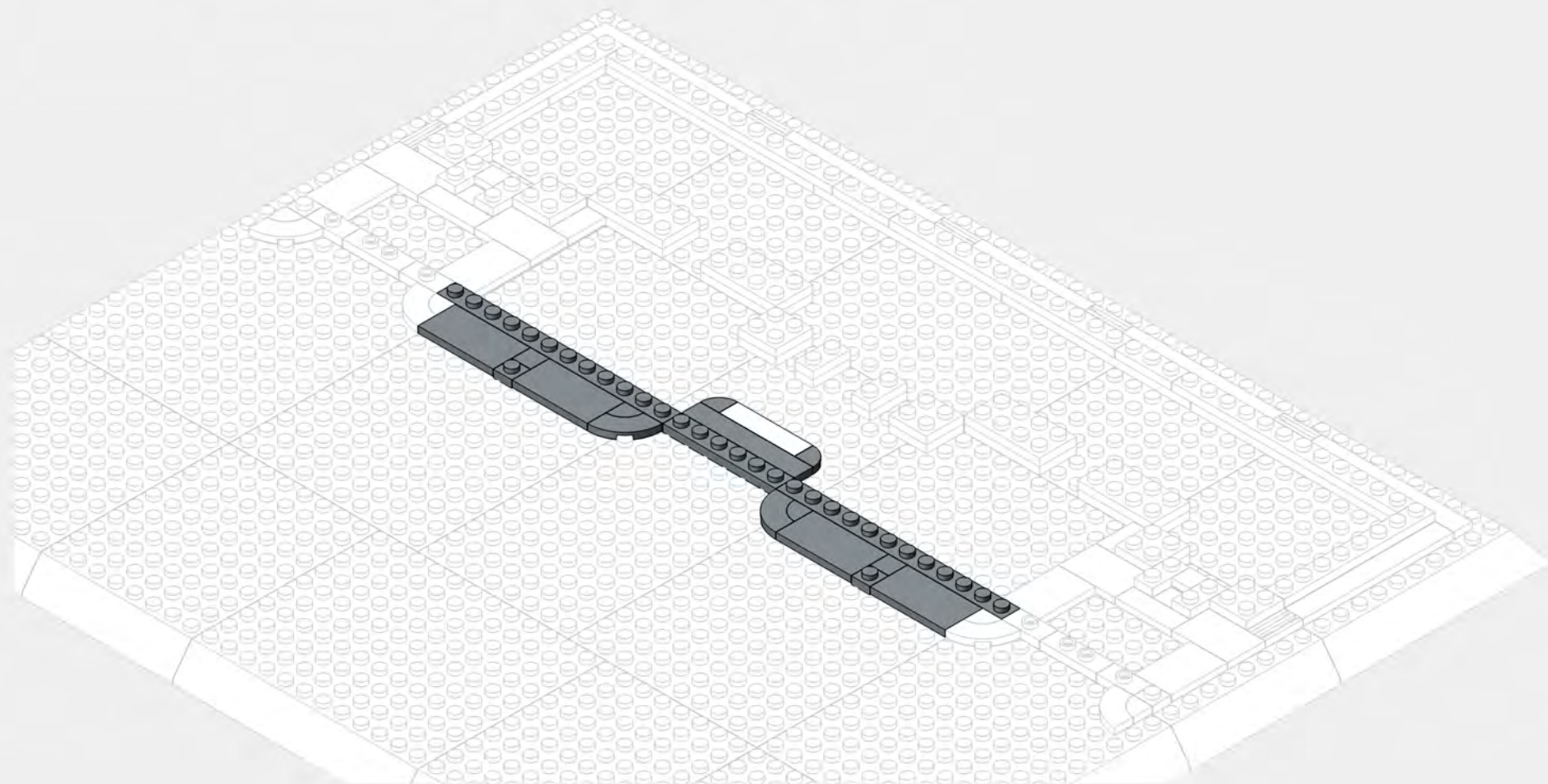
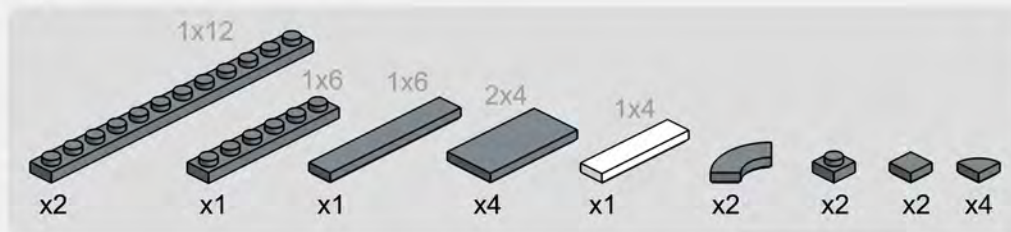

1-10

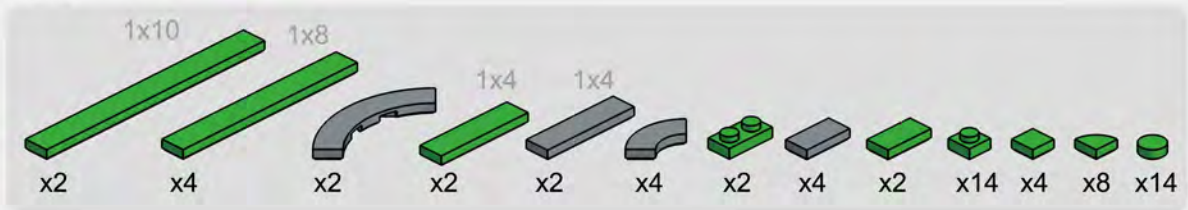



289PCS

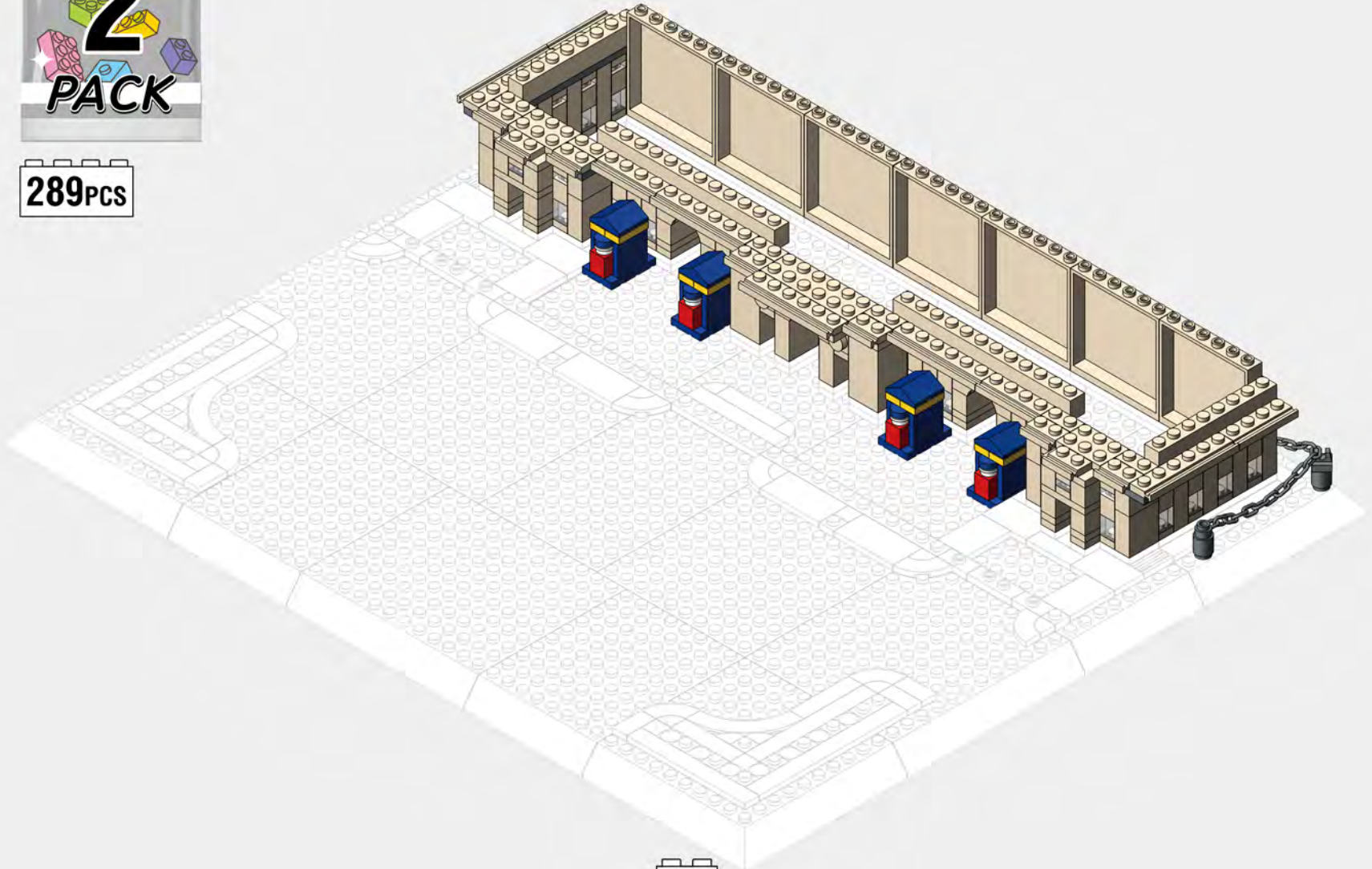

2-1

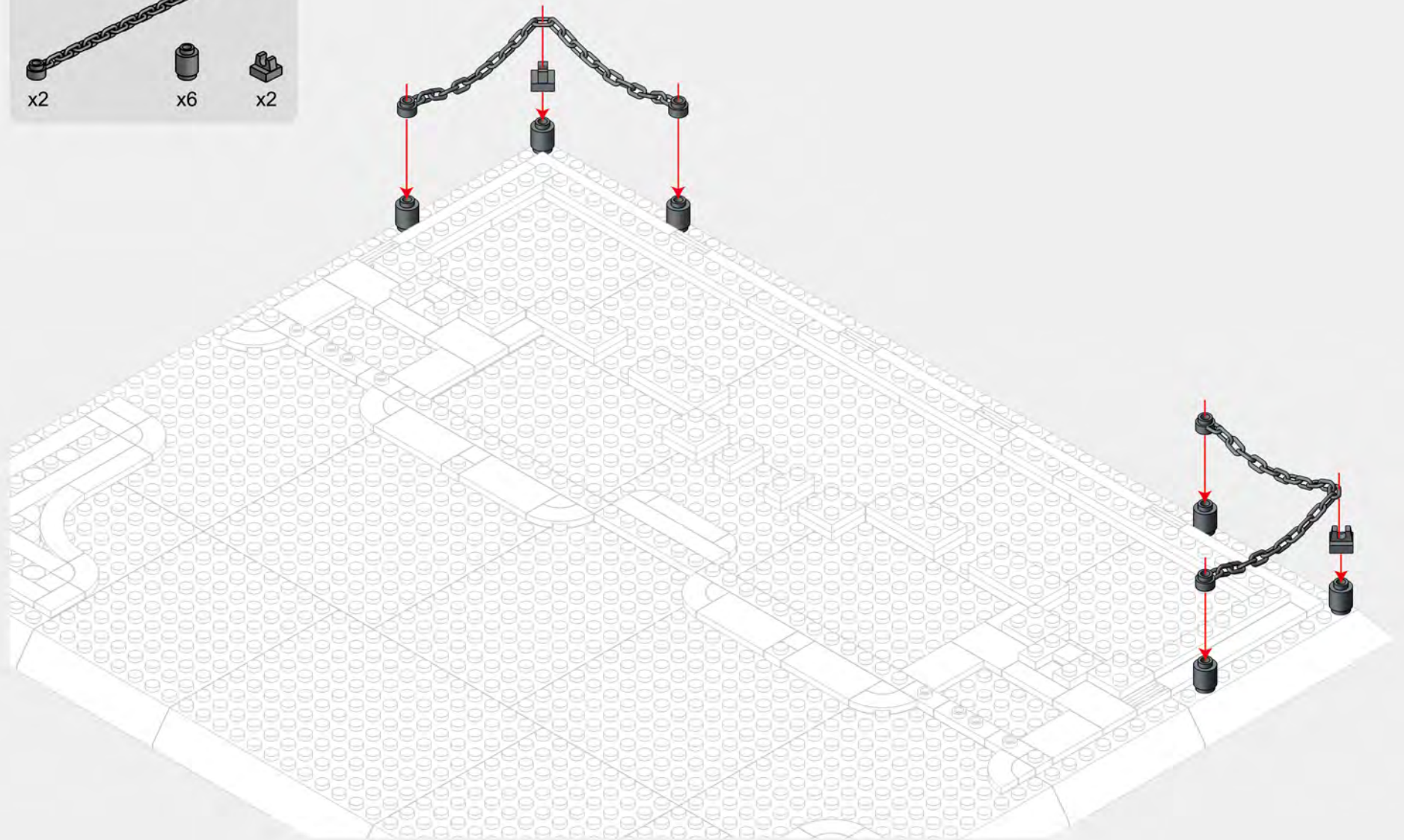
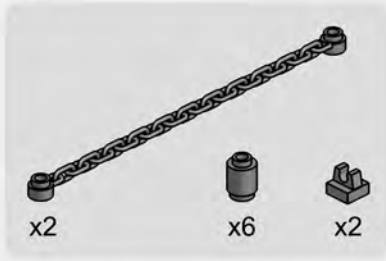

2-2

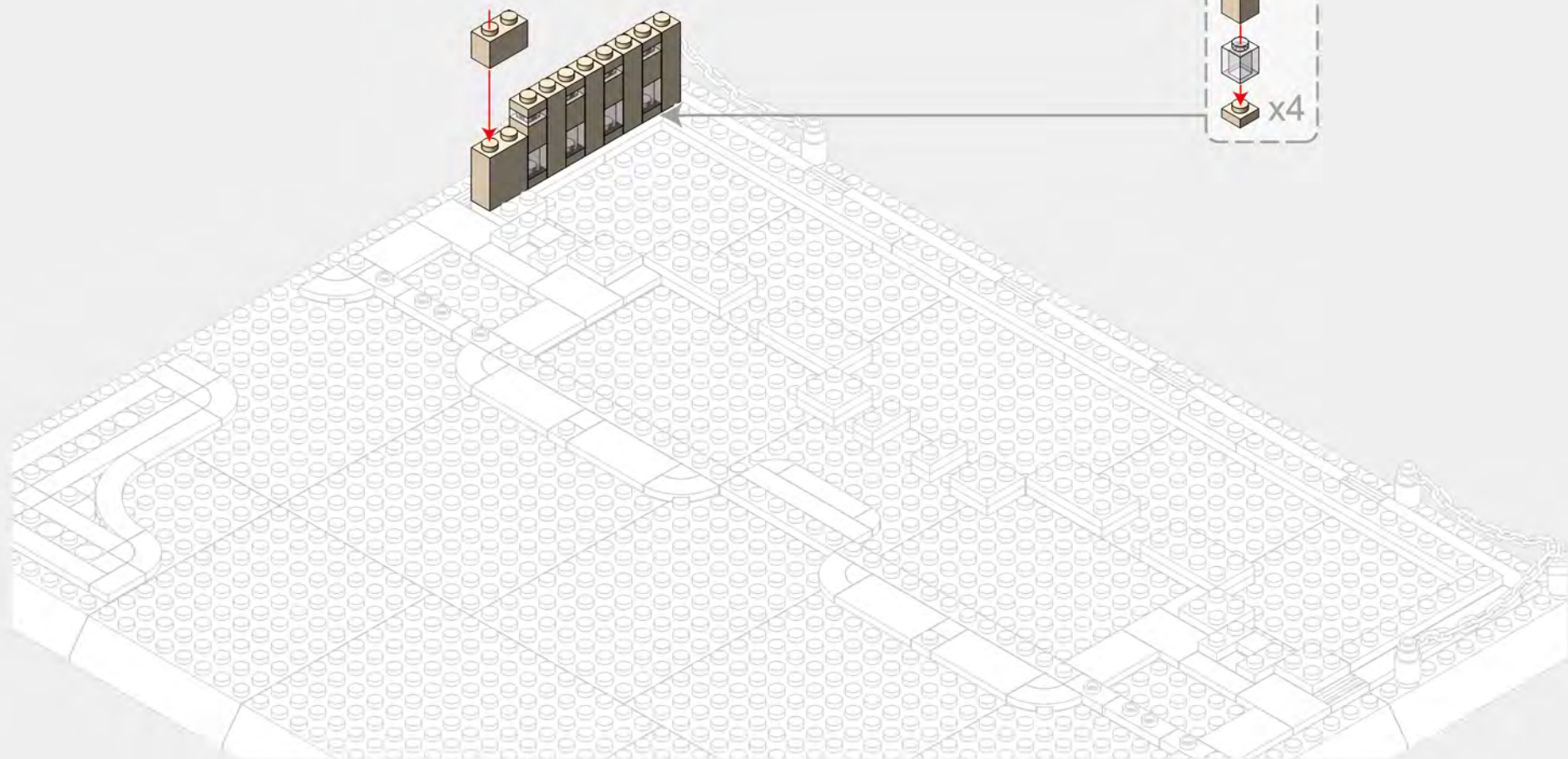
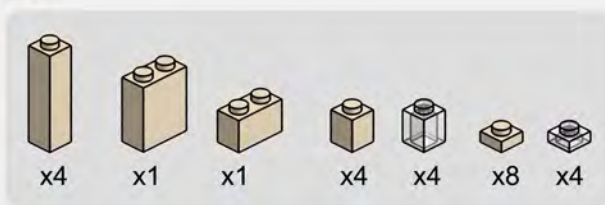

2-3

- 2x3 x1
- x4
- x2
- x2
- x6
- x1
- x4
- x2

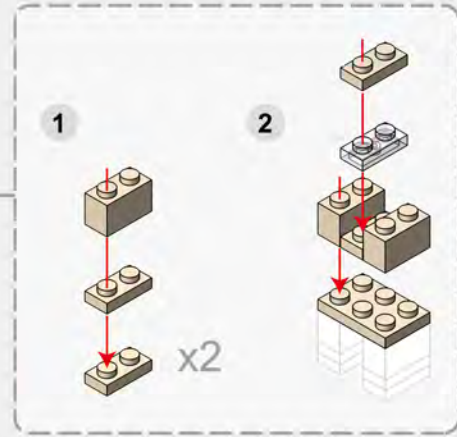
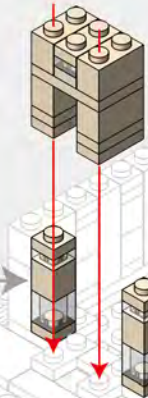
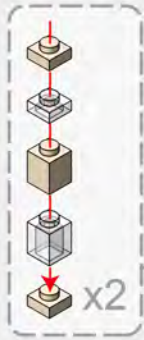

2-4

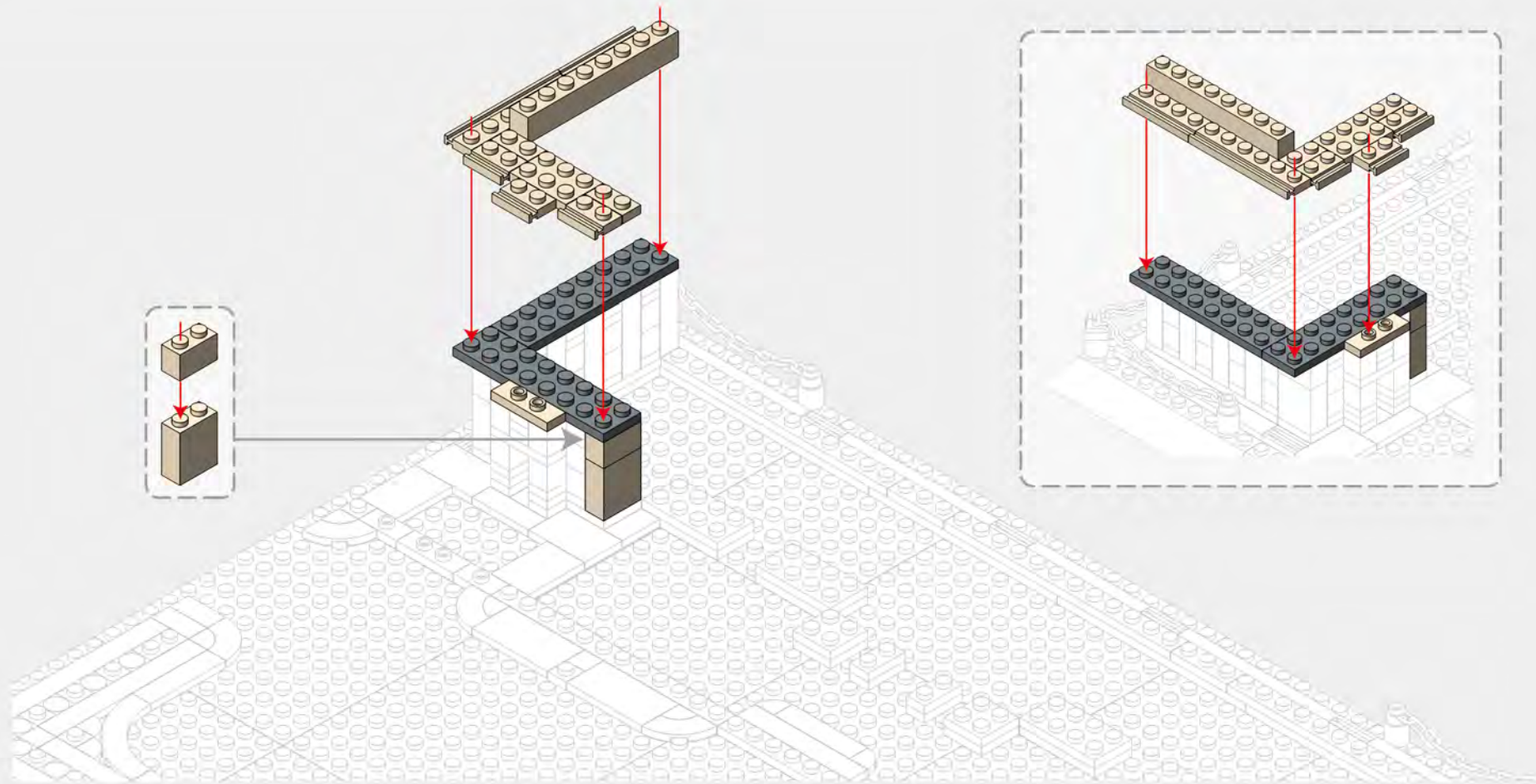
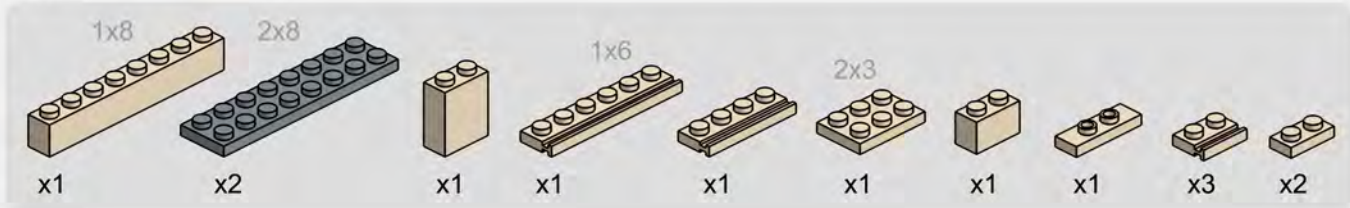

2-5

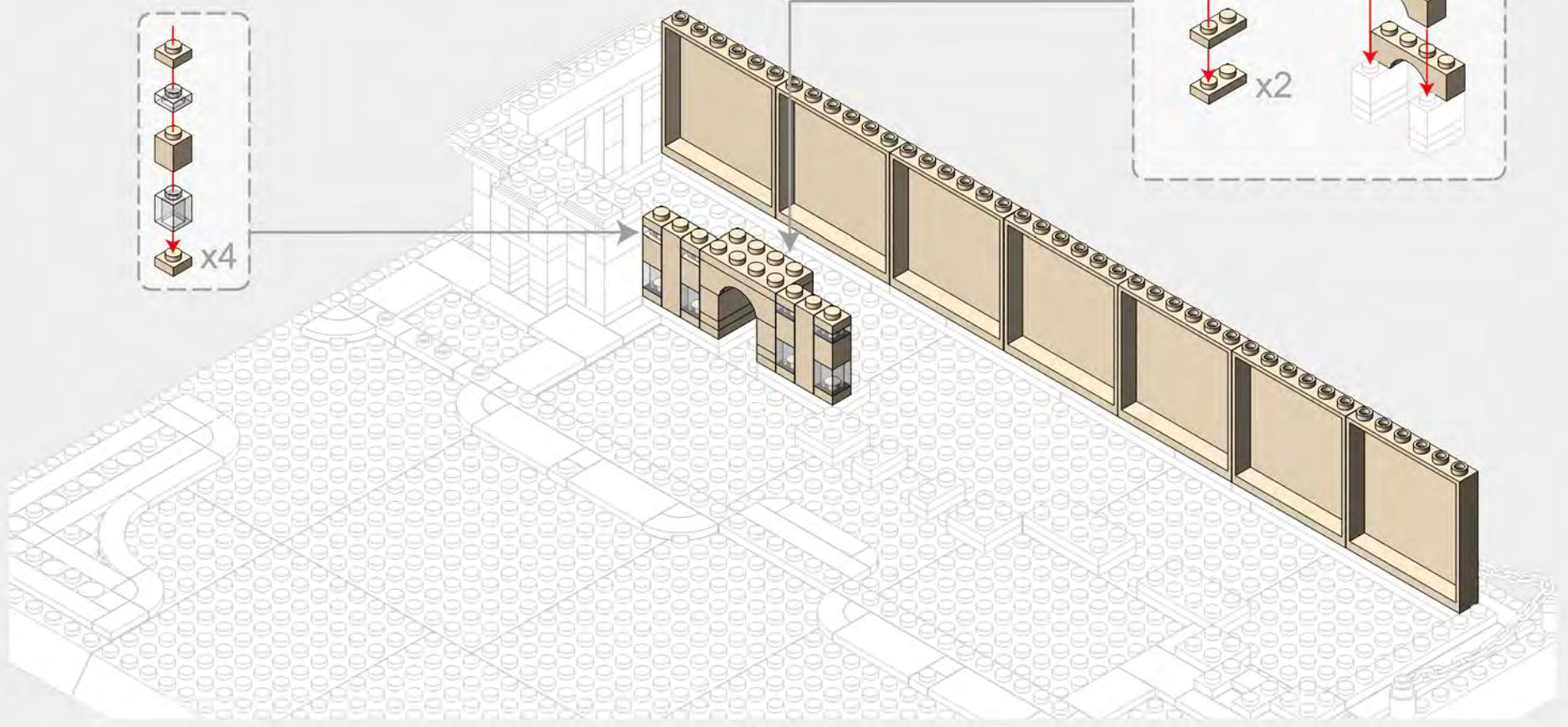
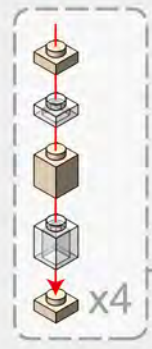
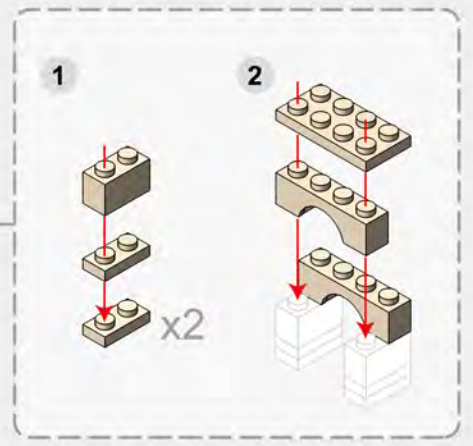
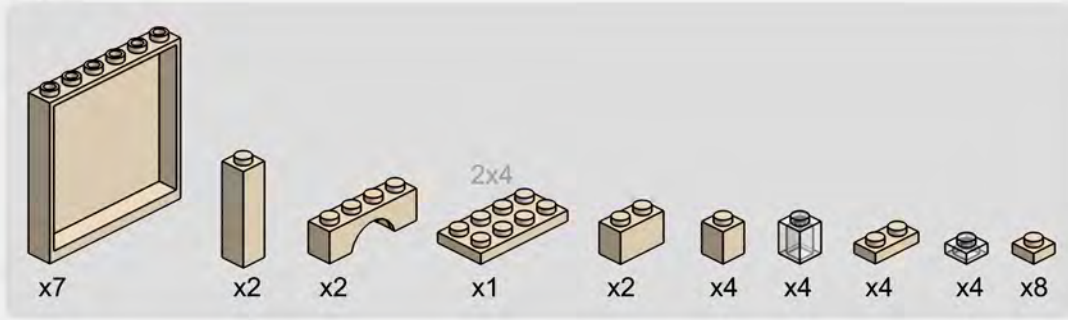

2-6

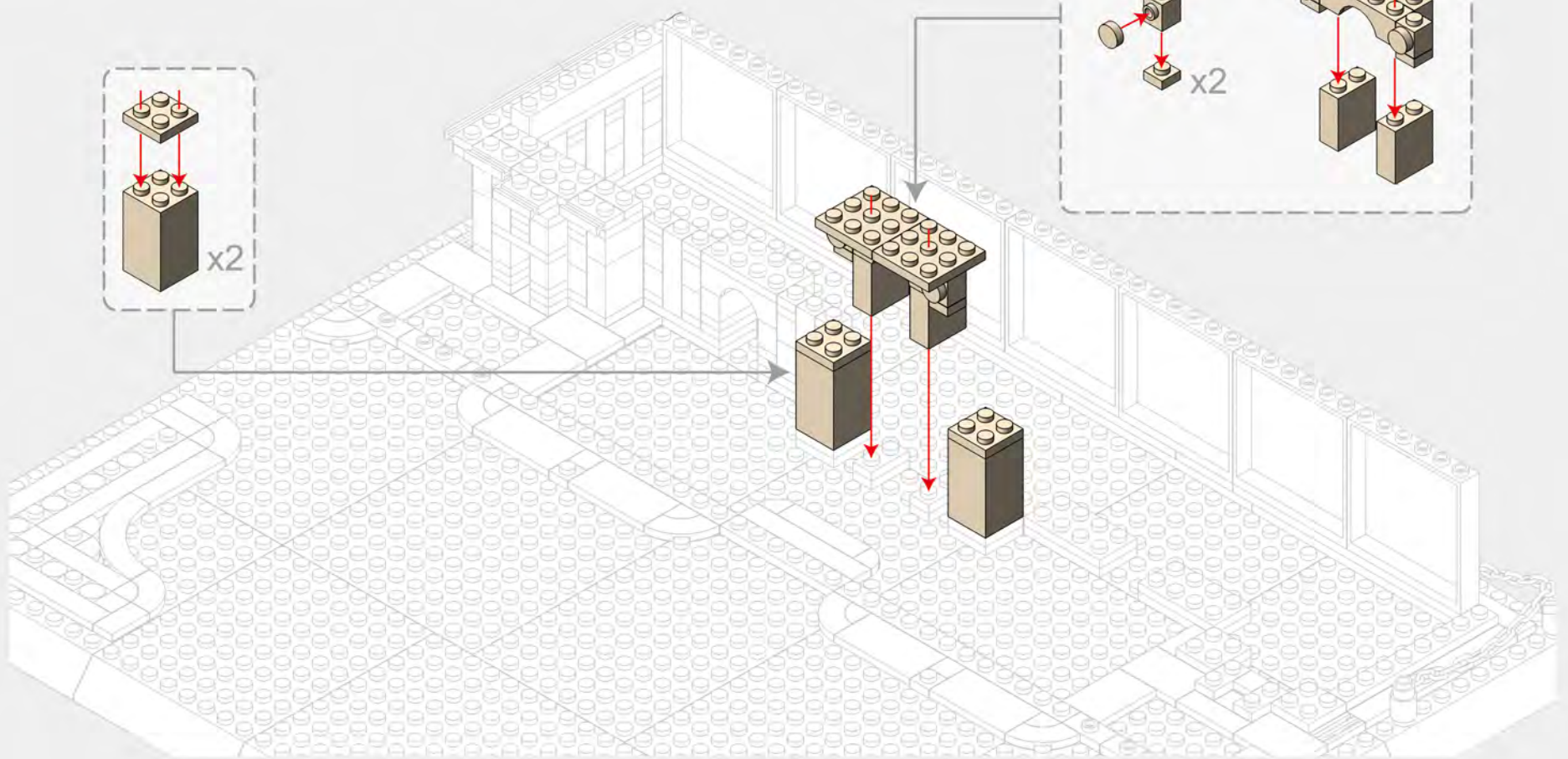
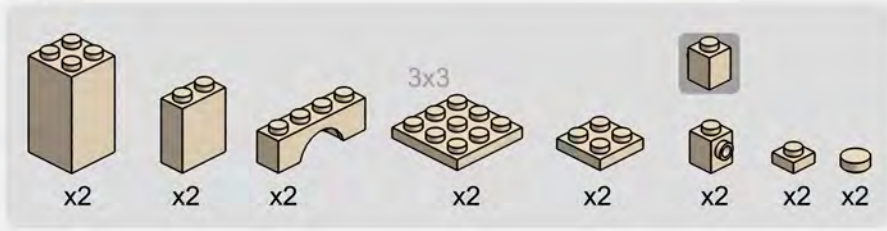

2-7

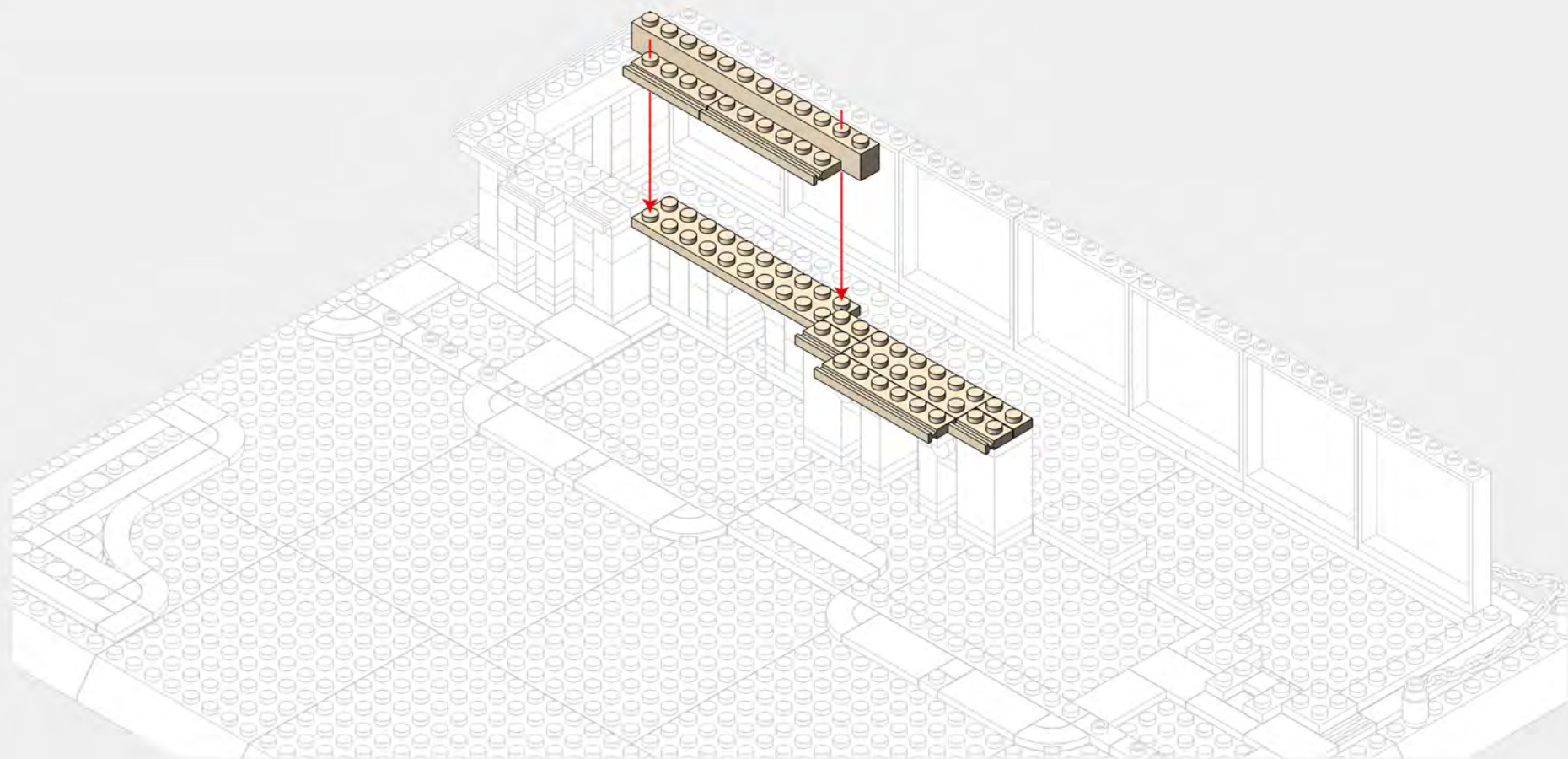
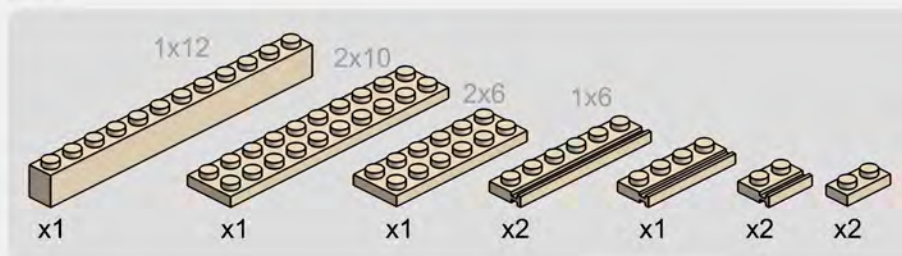

2-8

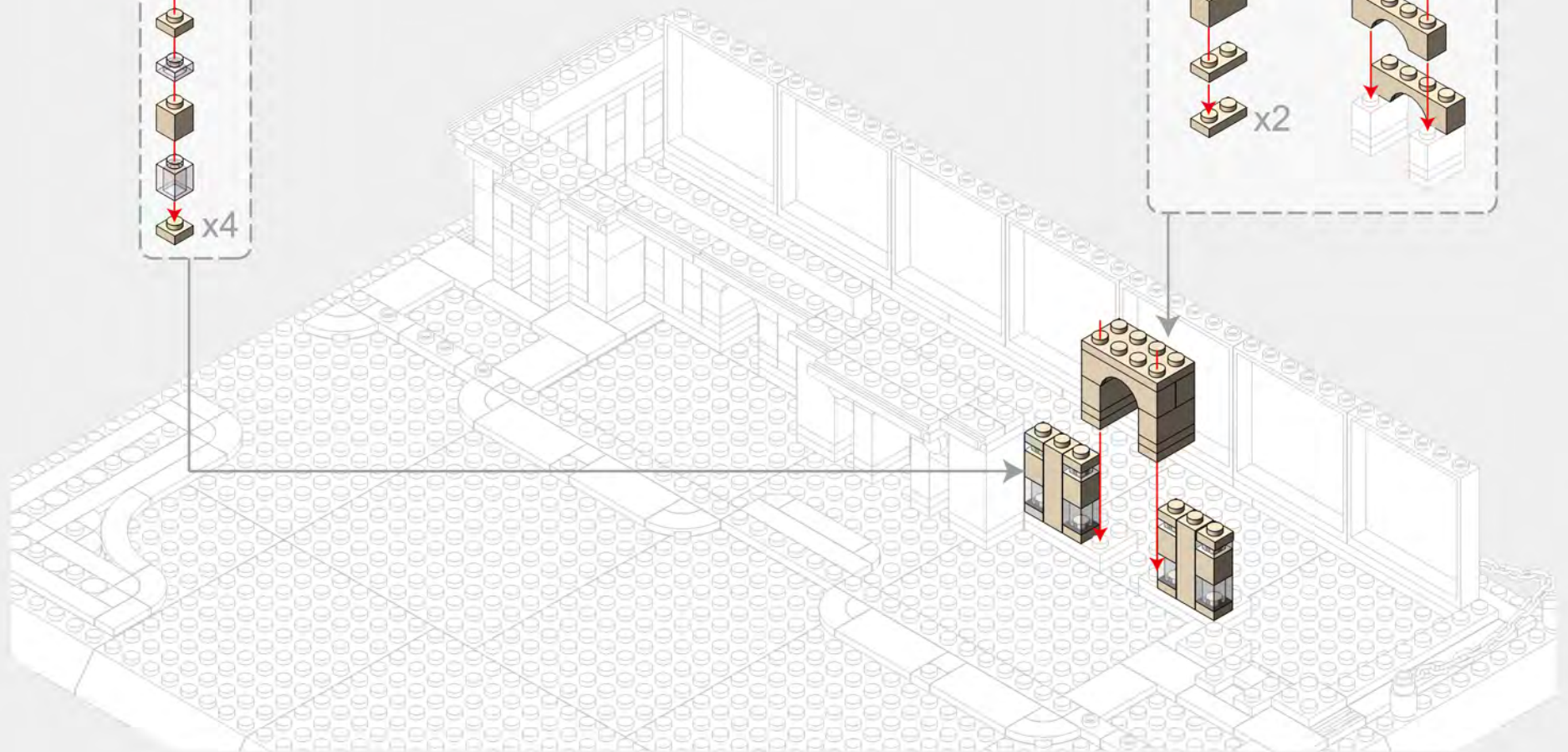
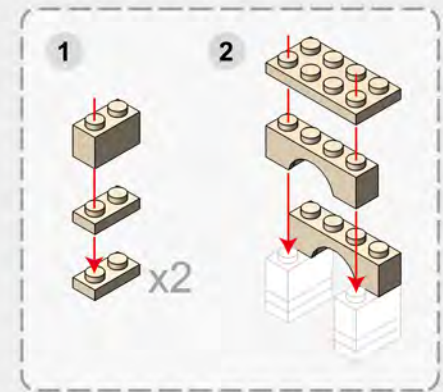
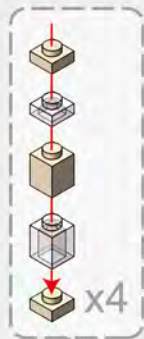
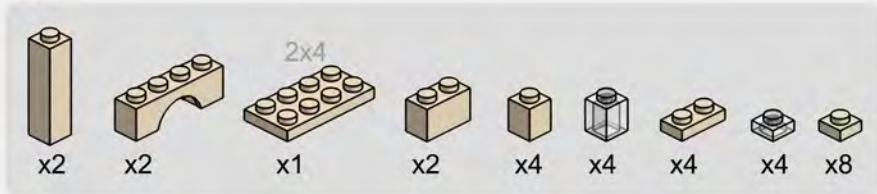

2-9

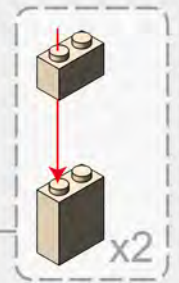
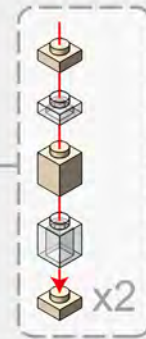
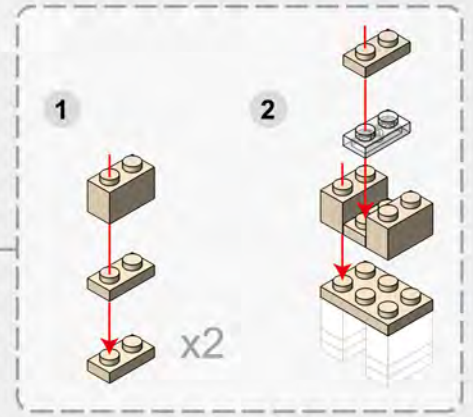
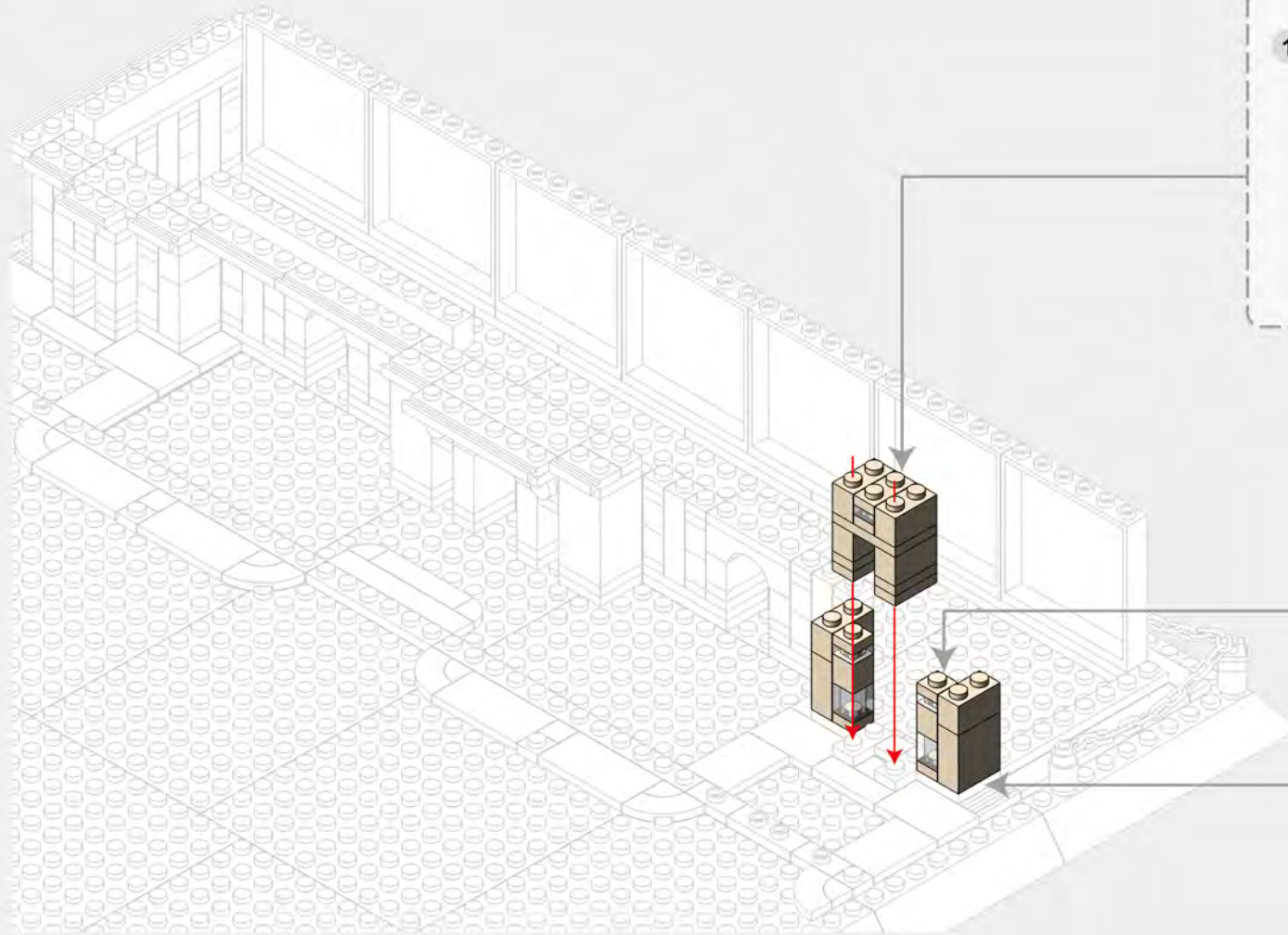

2-10

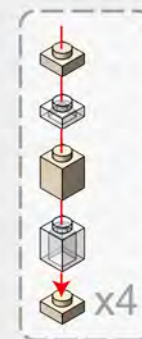
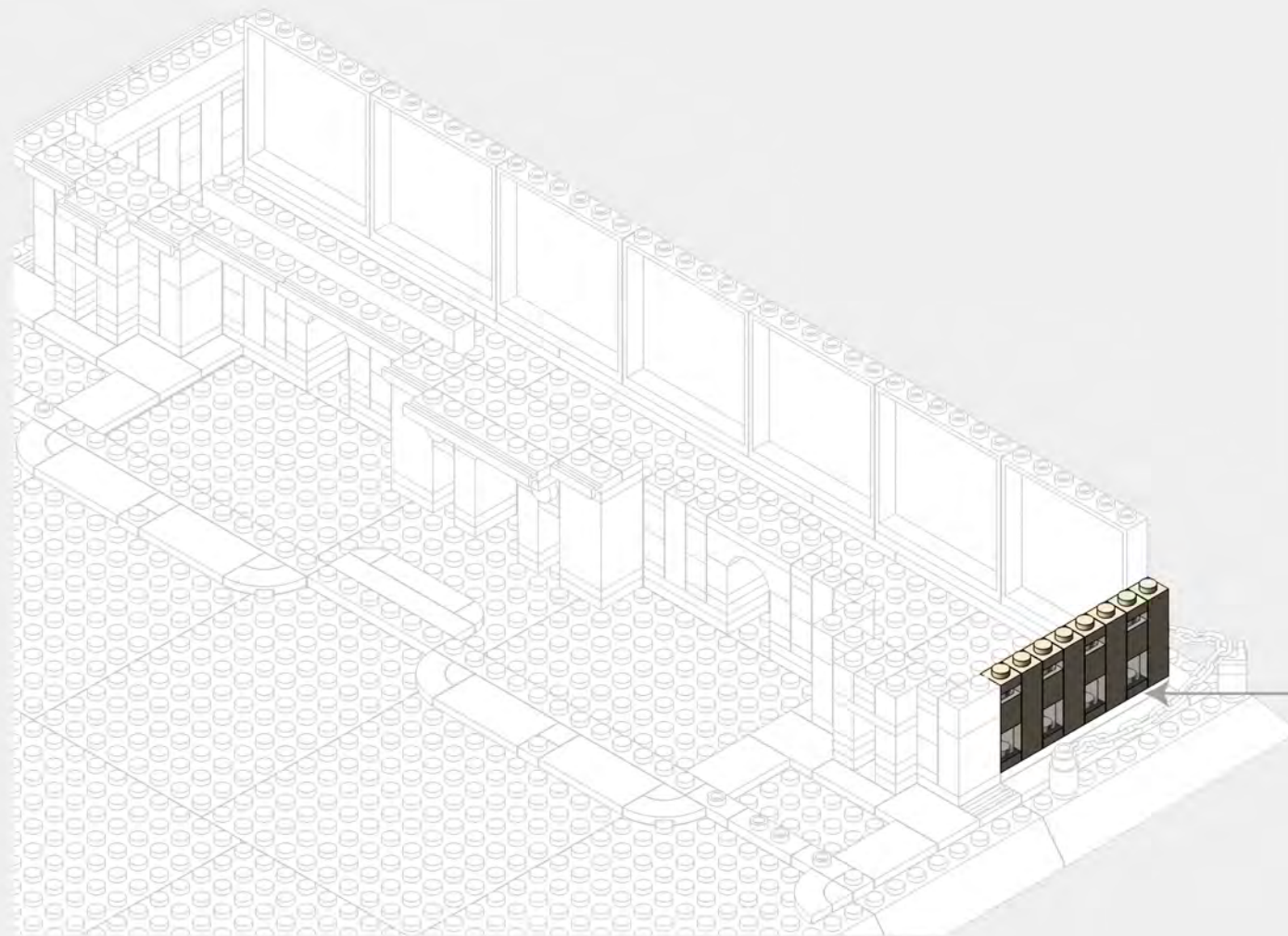

2-11

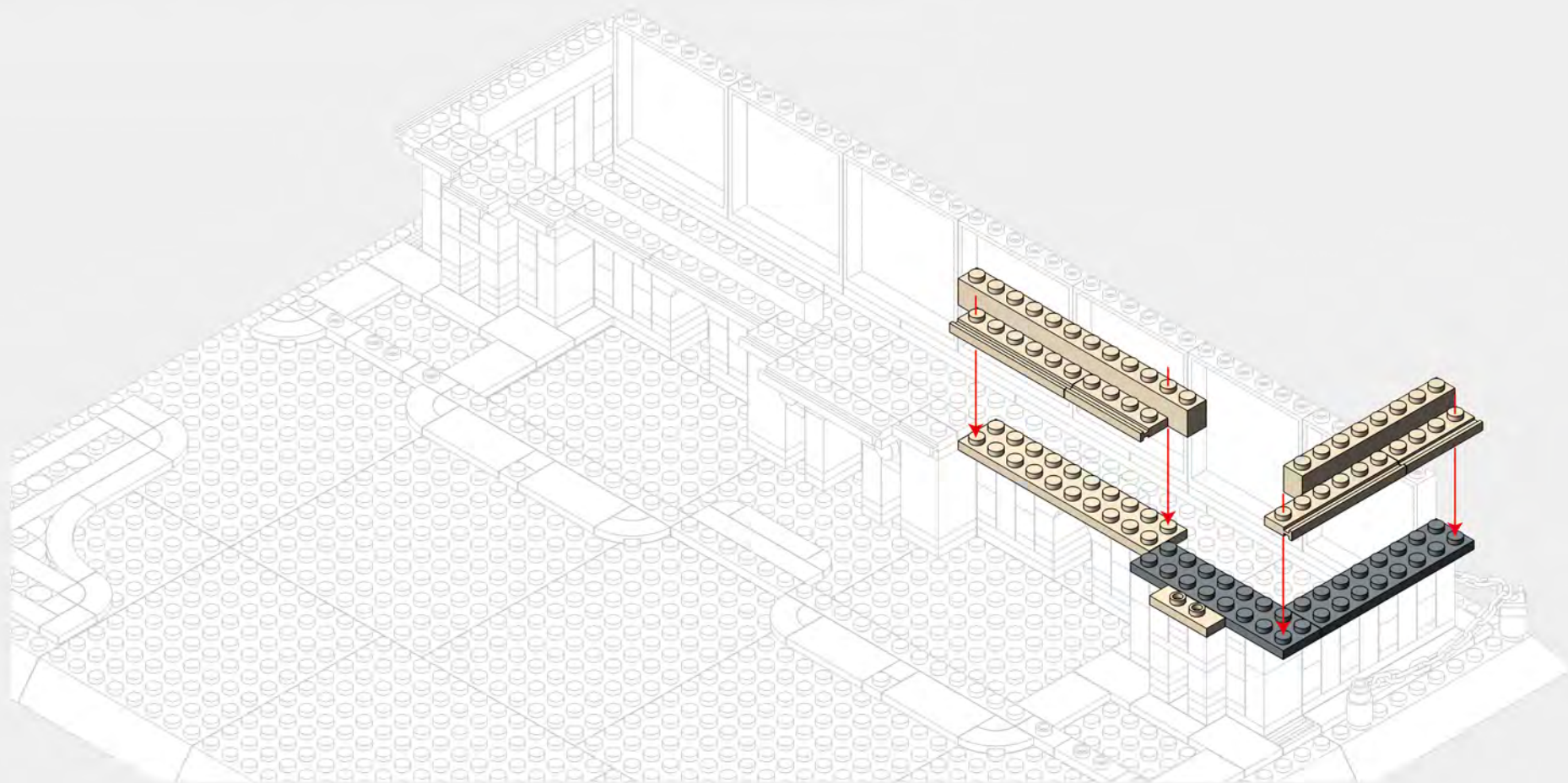
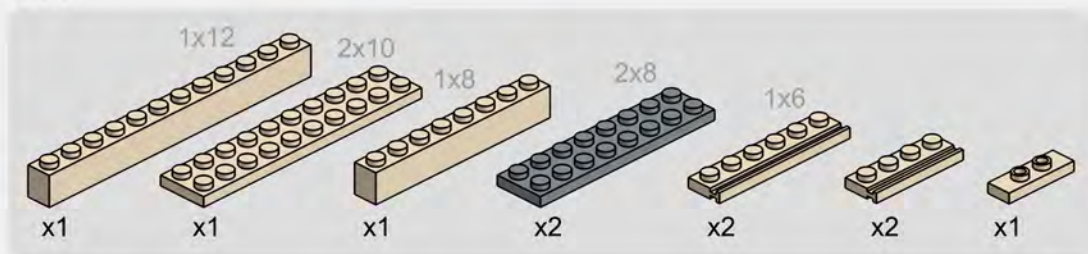

2-12

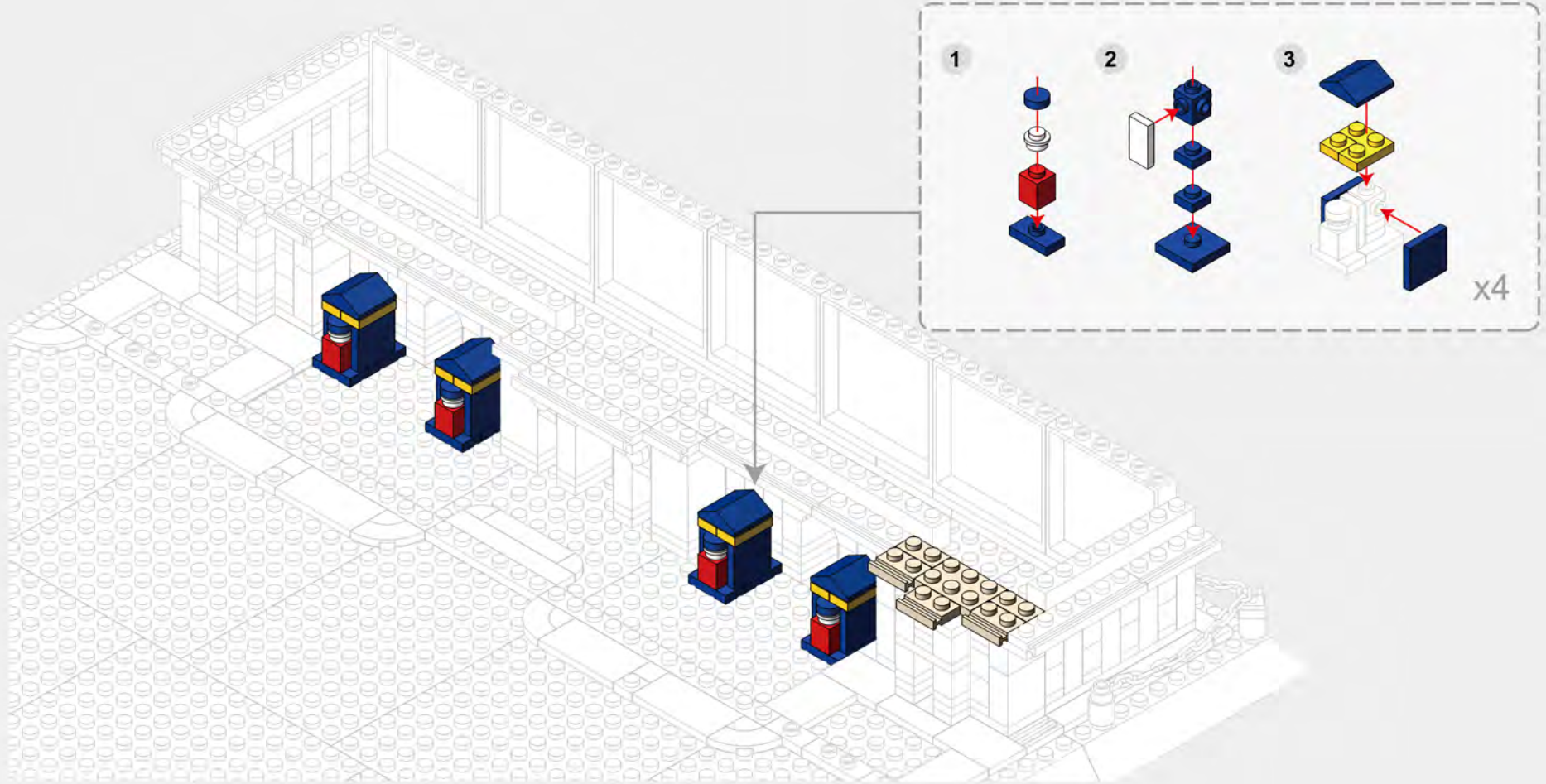
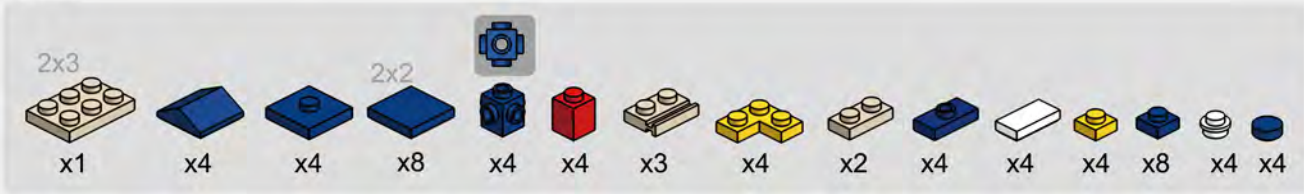



280PCS

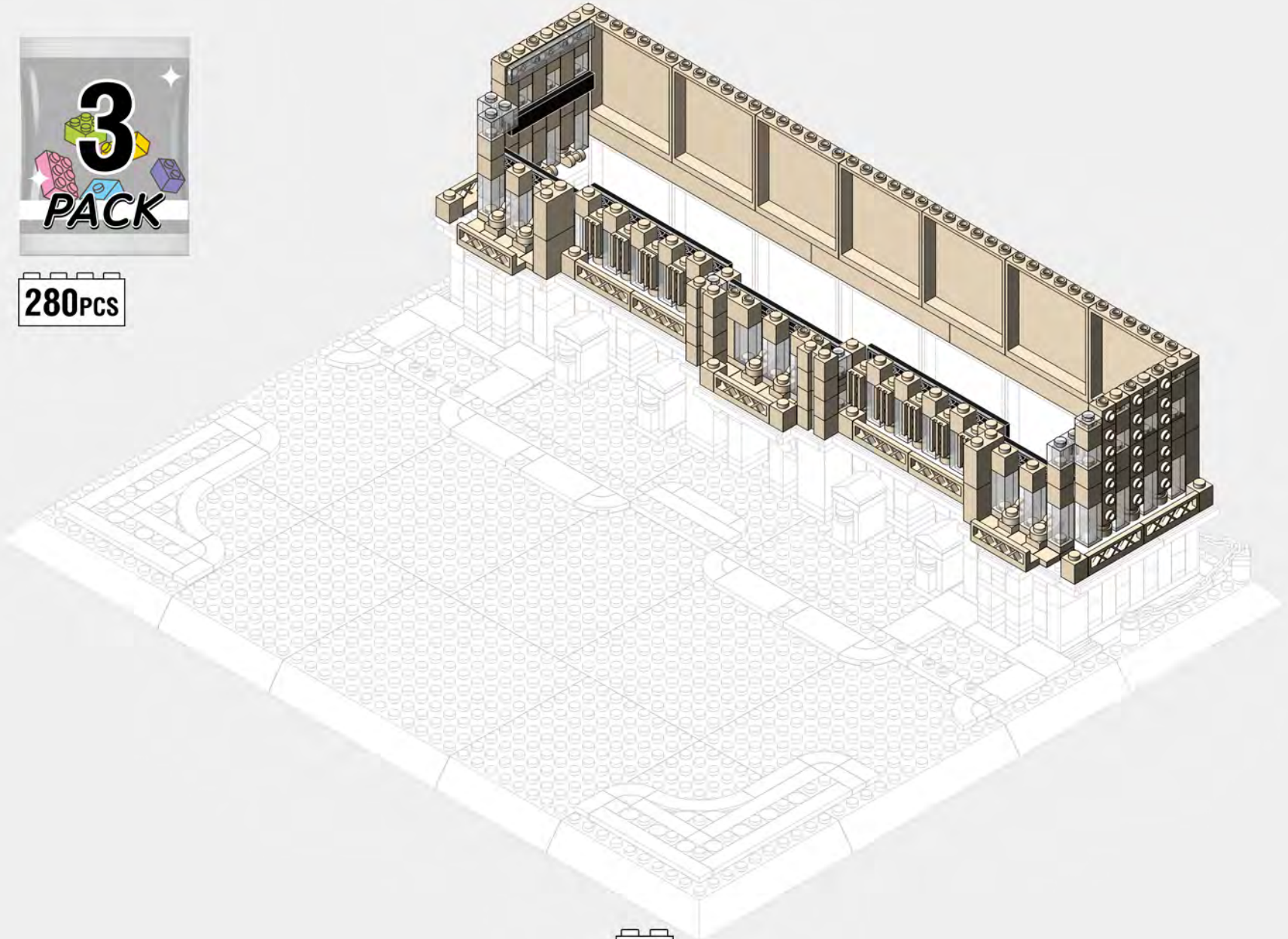

3-1

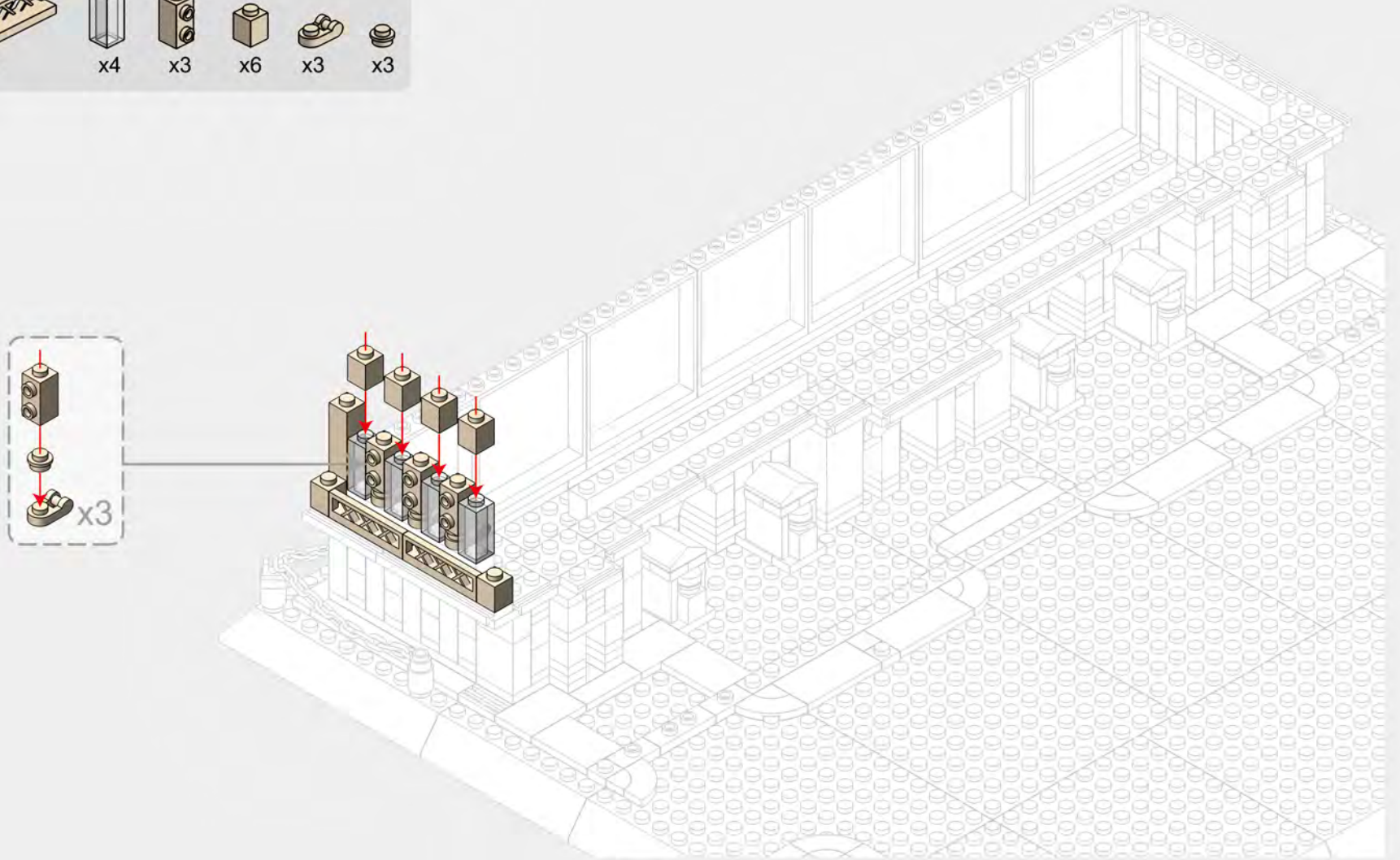
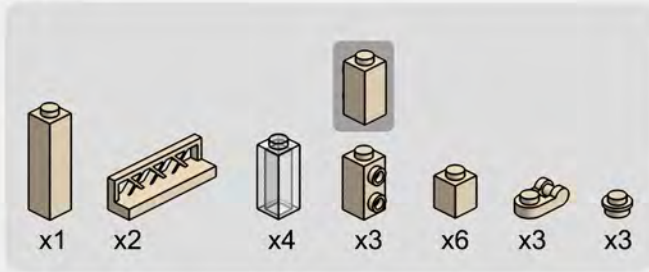

3-2

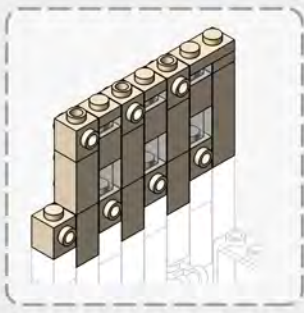
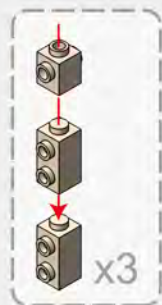
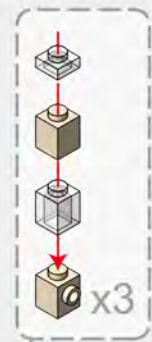
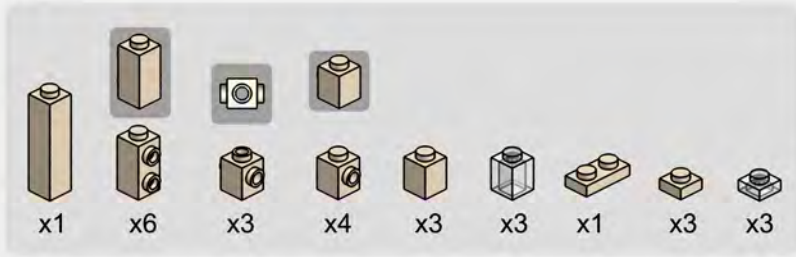

3-3

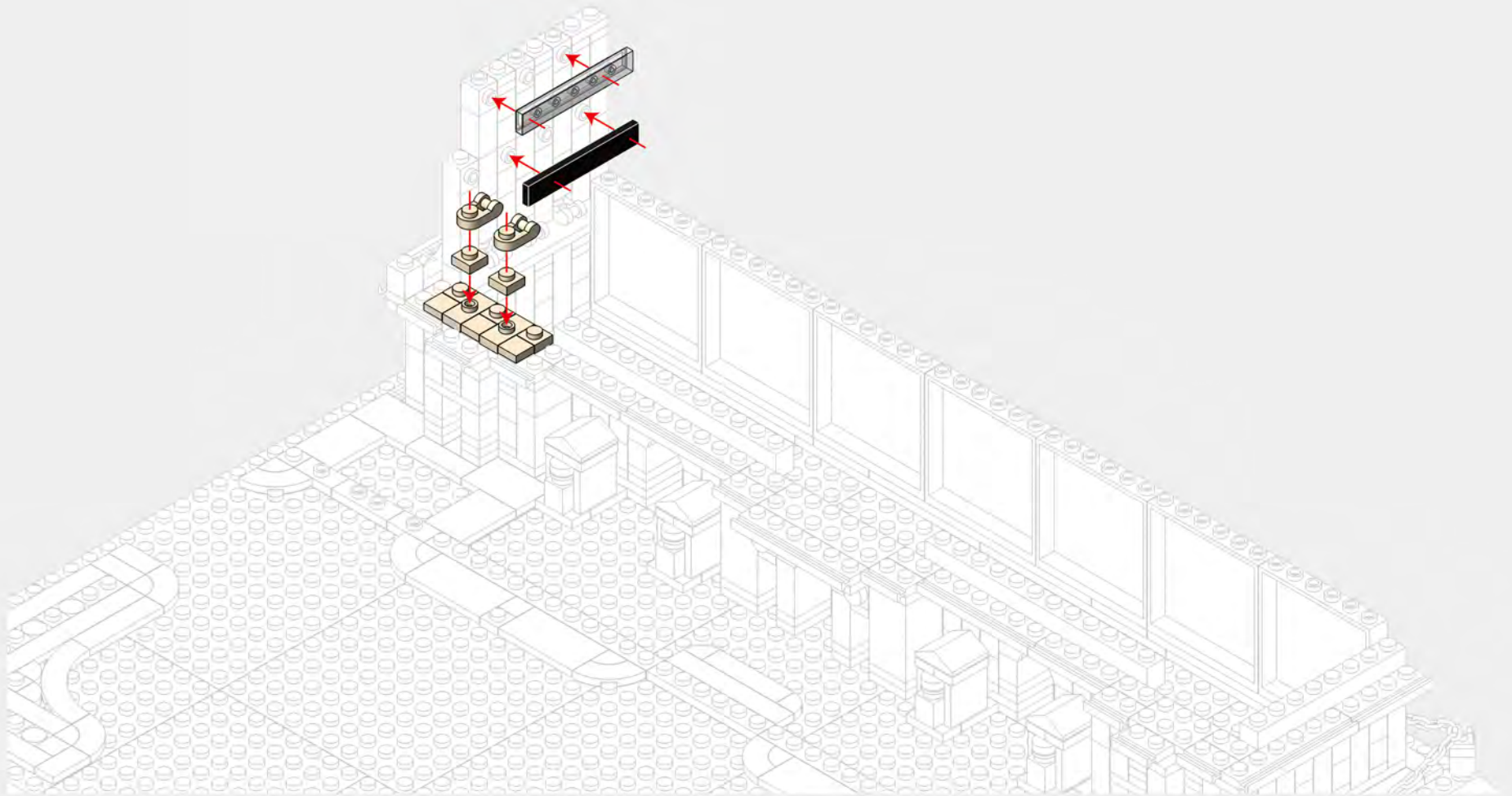
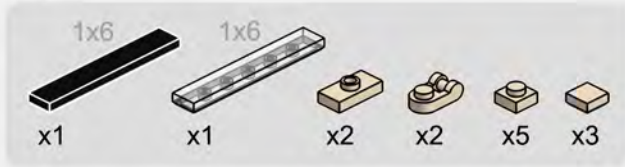

3-5

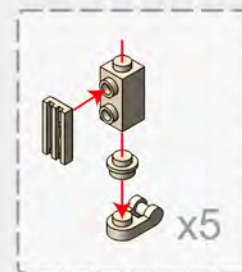
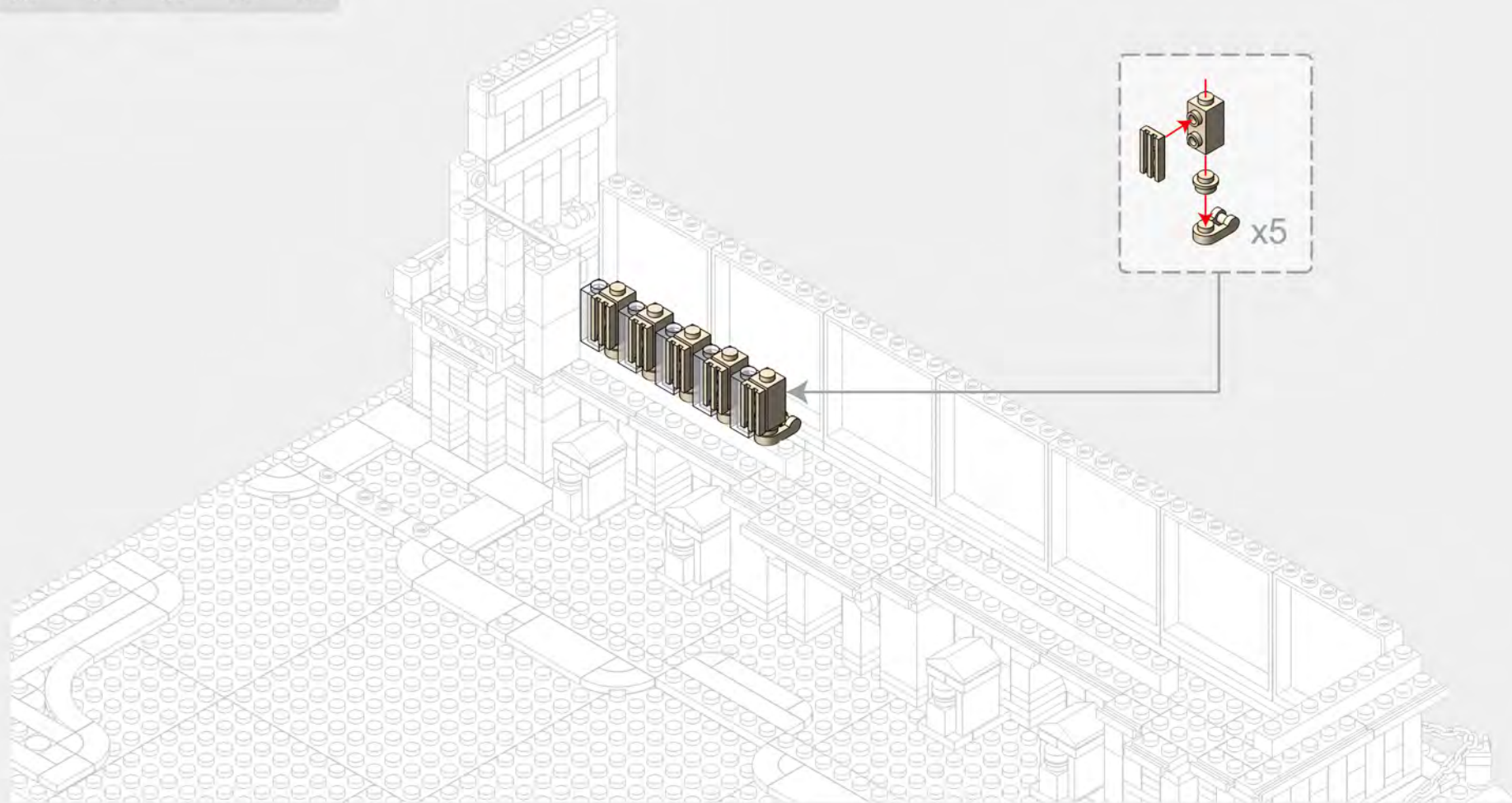
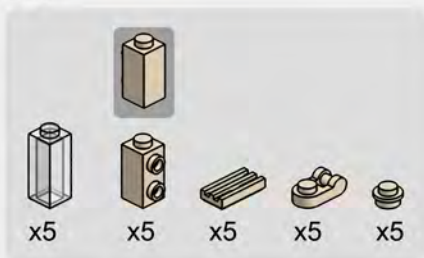

3-6

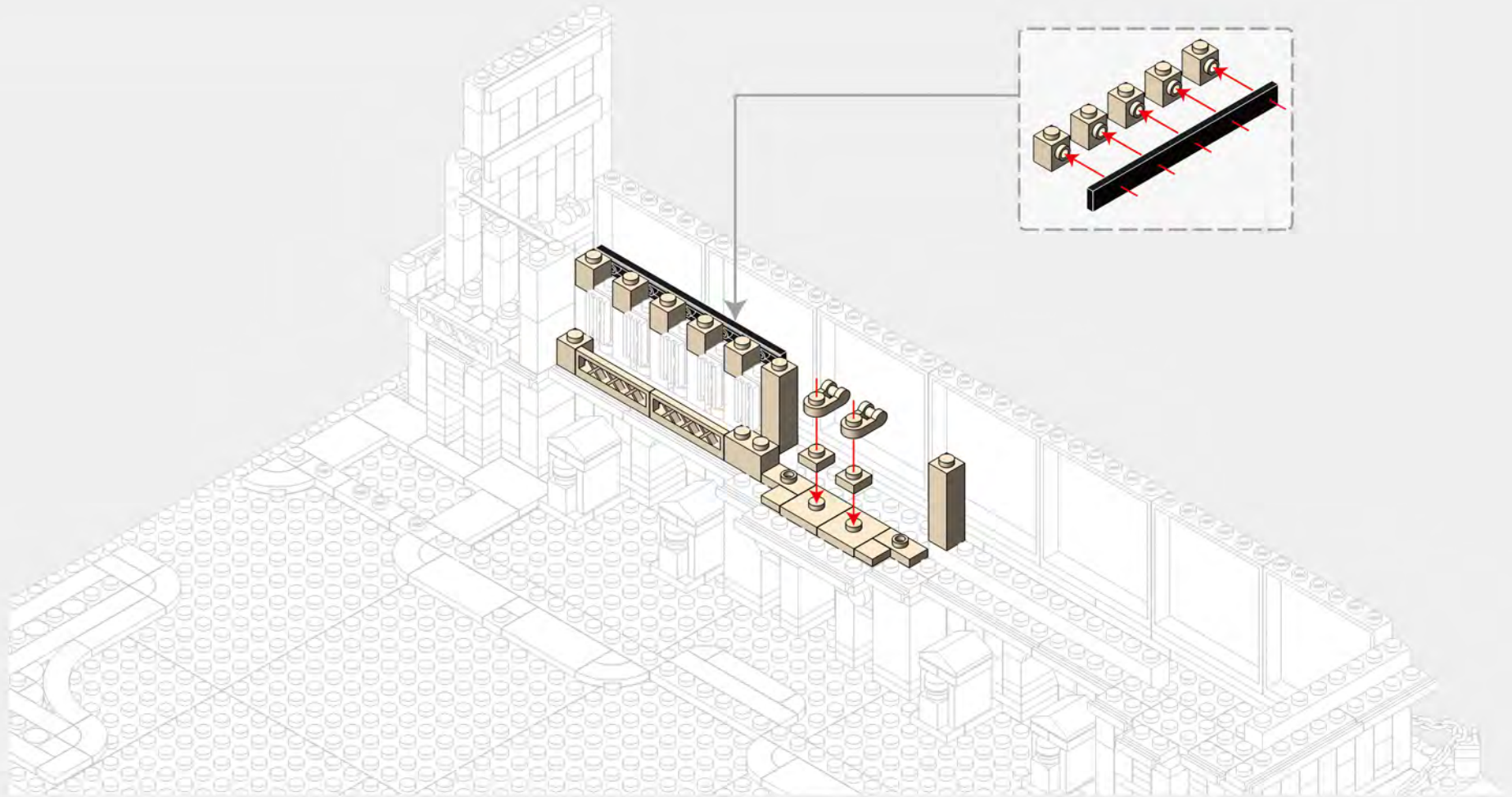
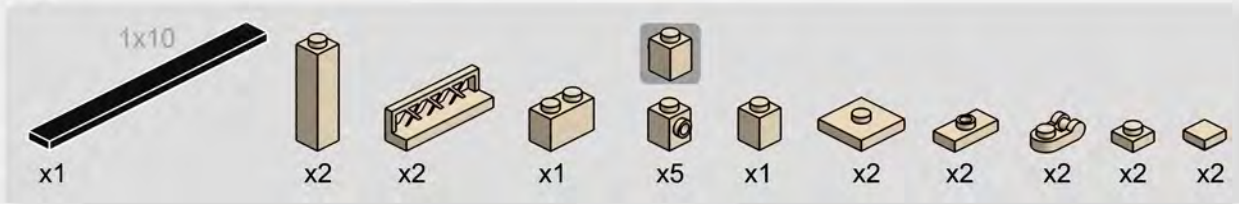

3-7

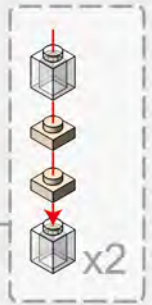
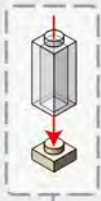
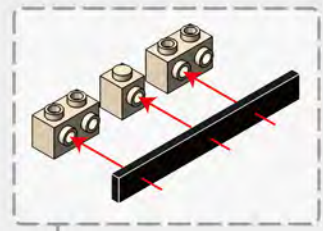
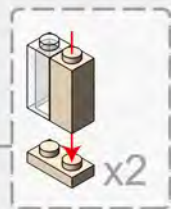
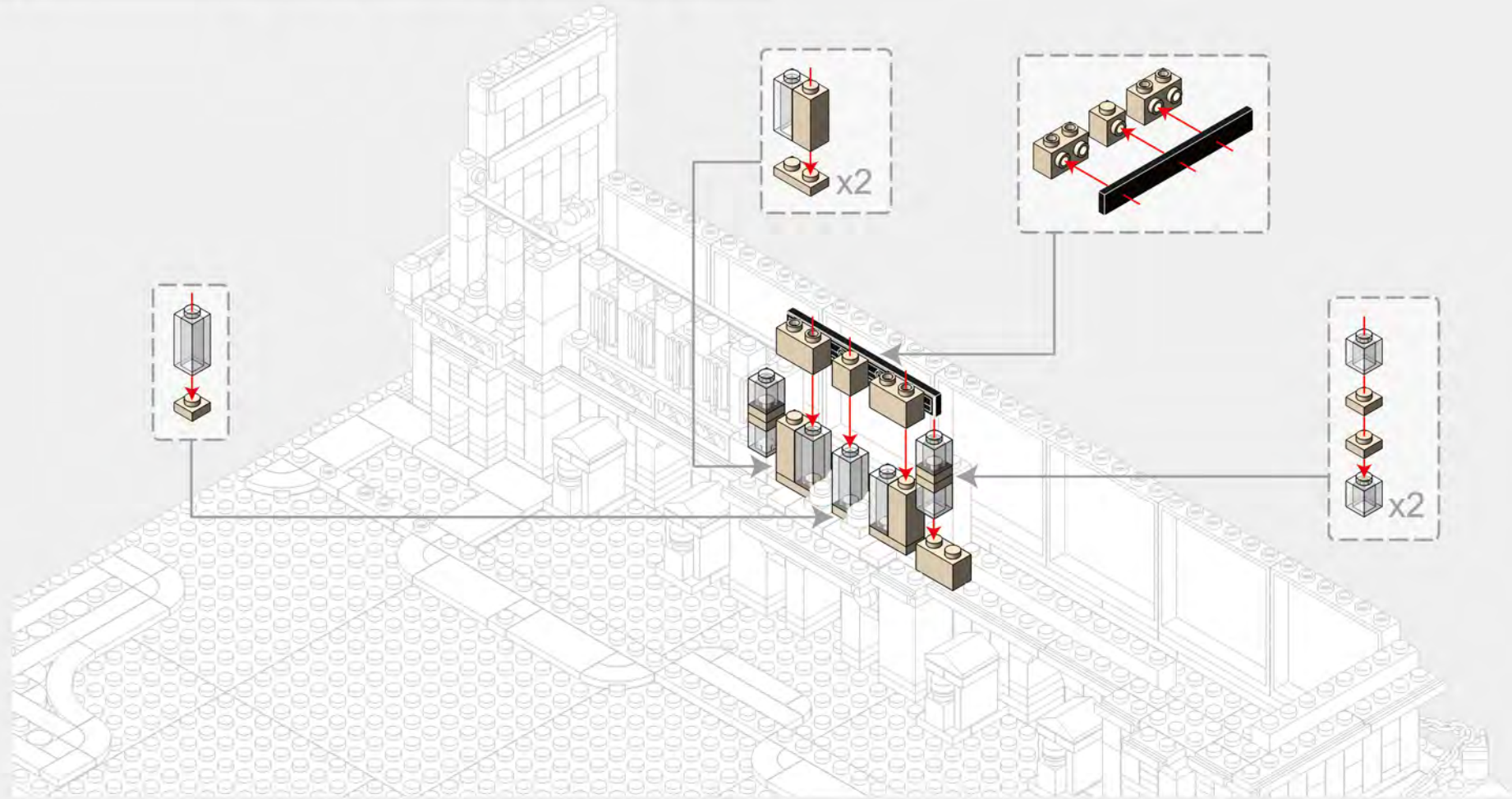
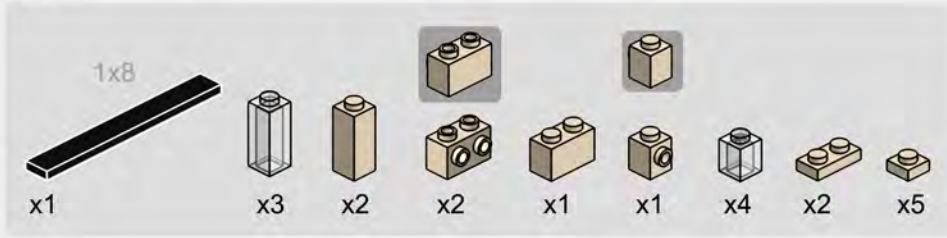

3-8

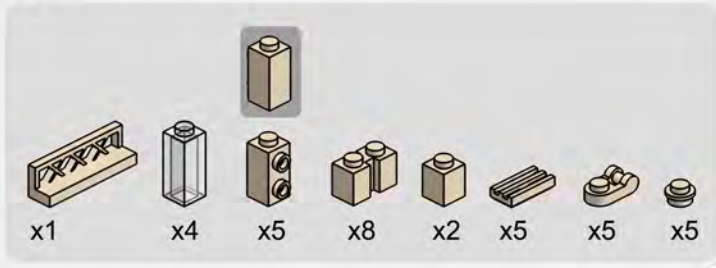

3-9

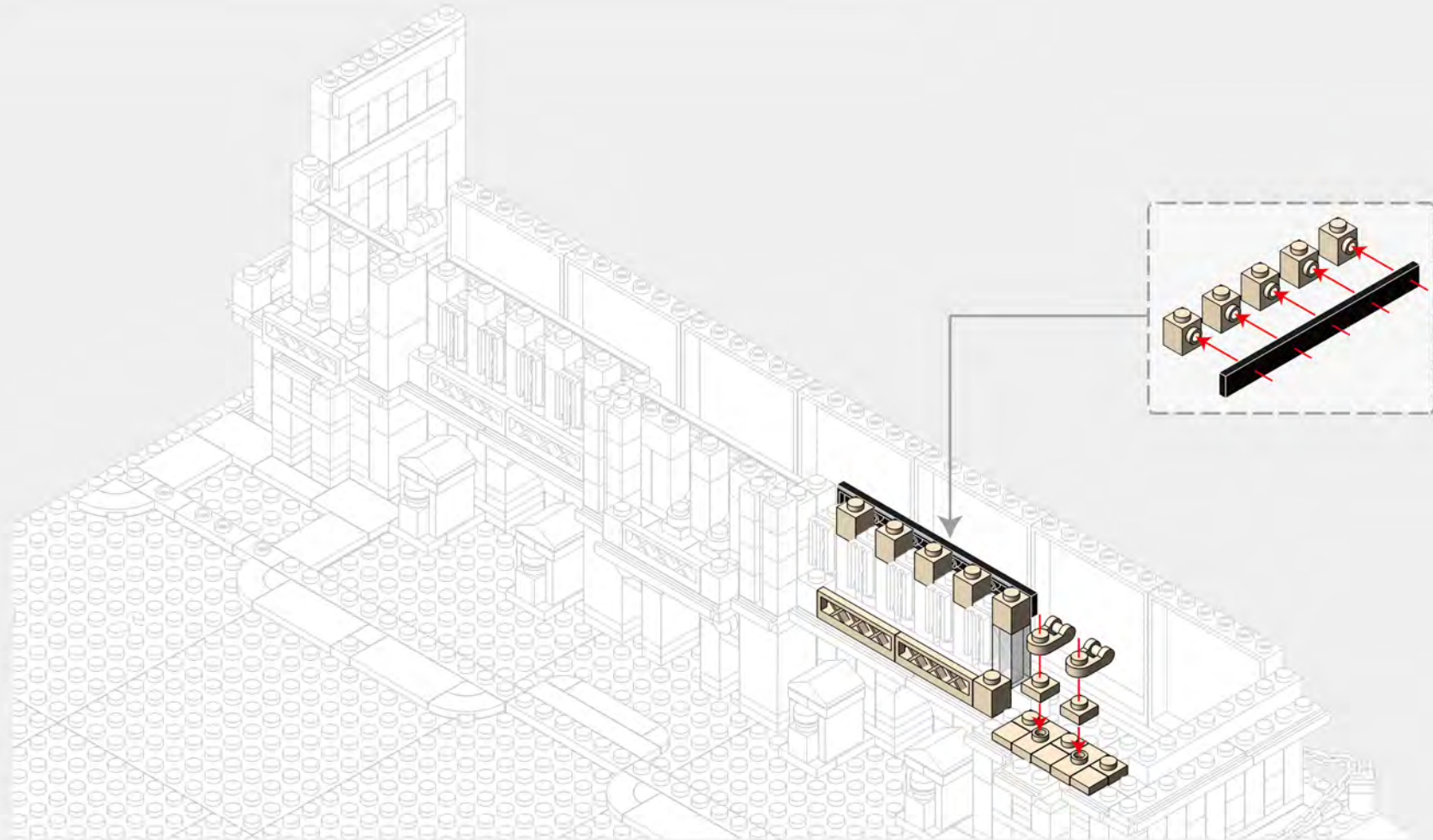
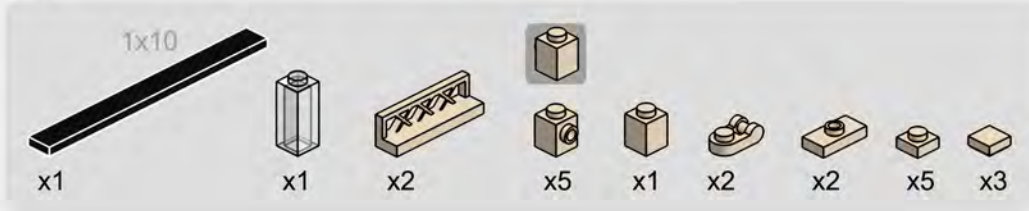

3-10

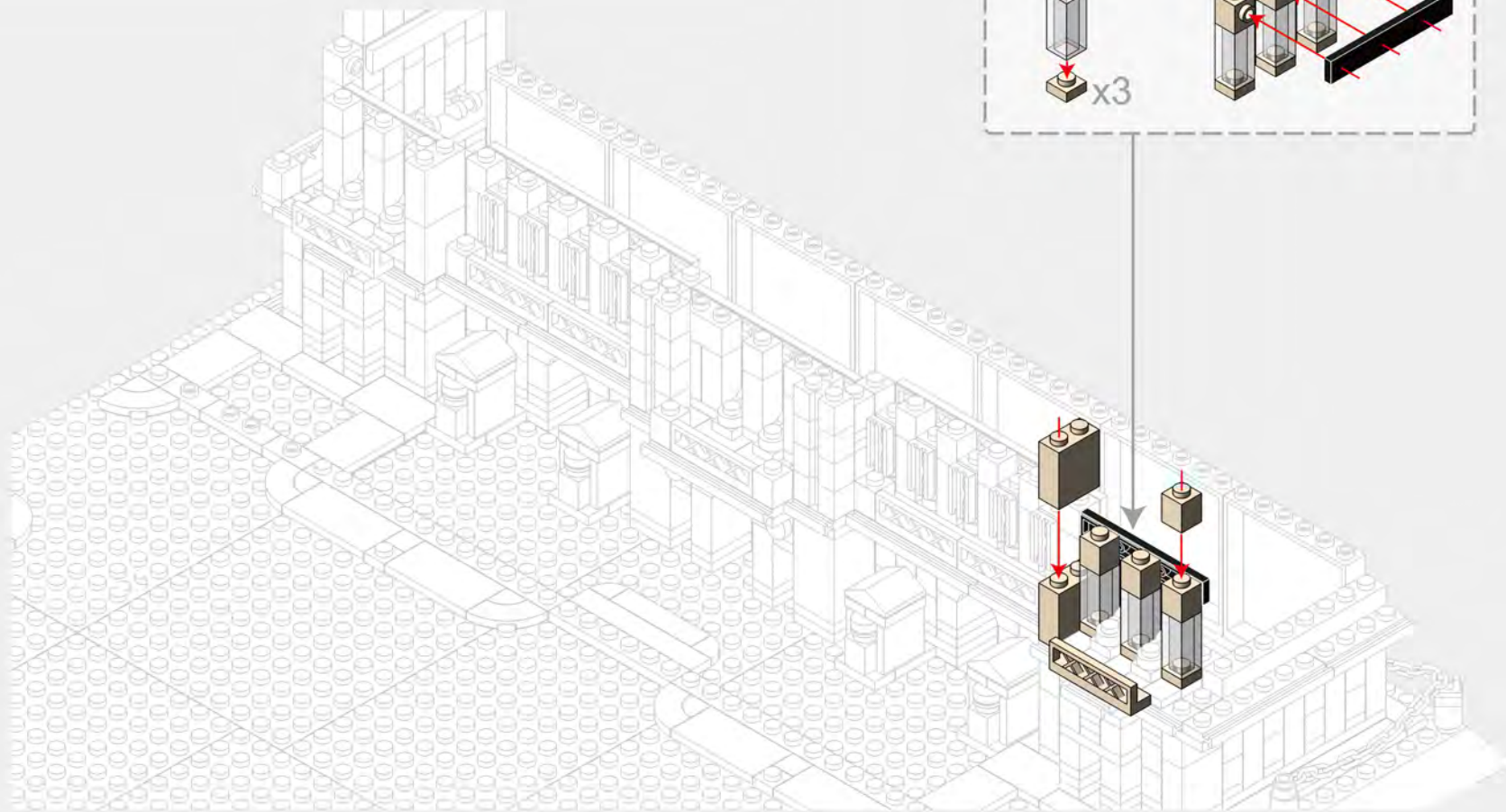
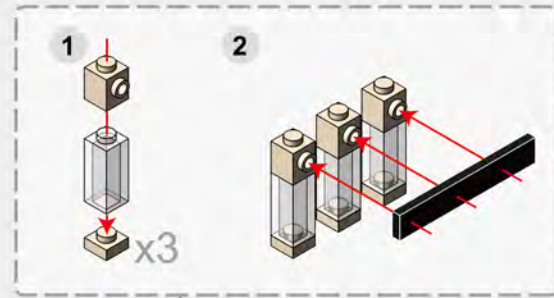
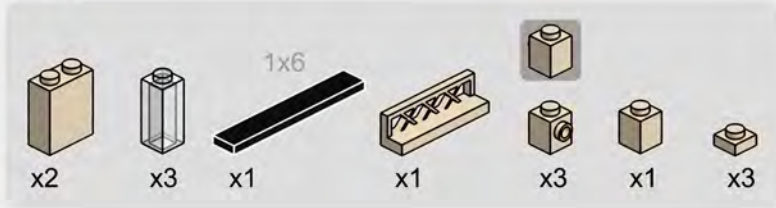

3-11

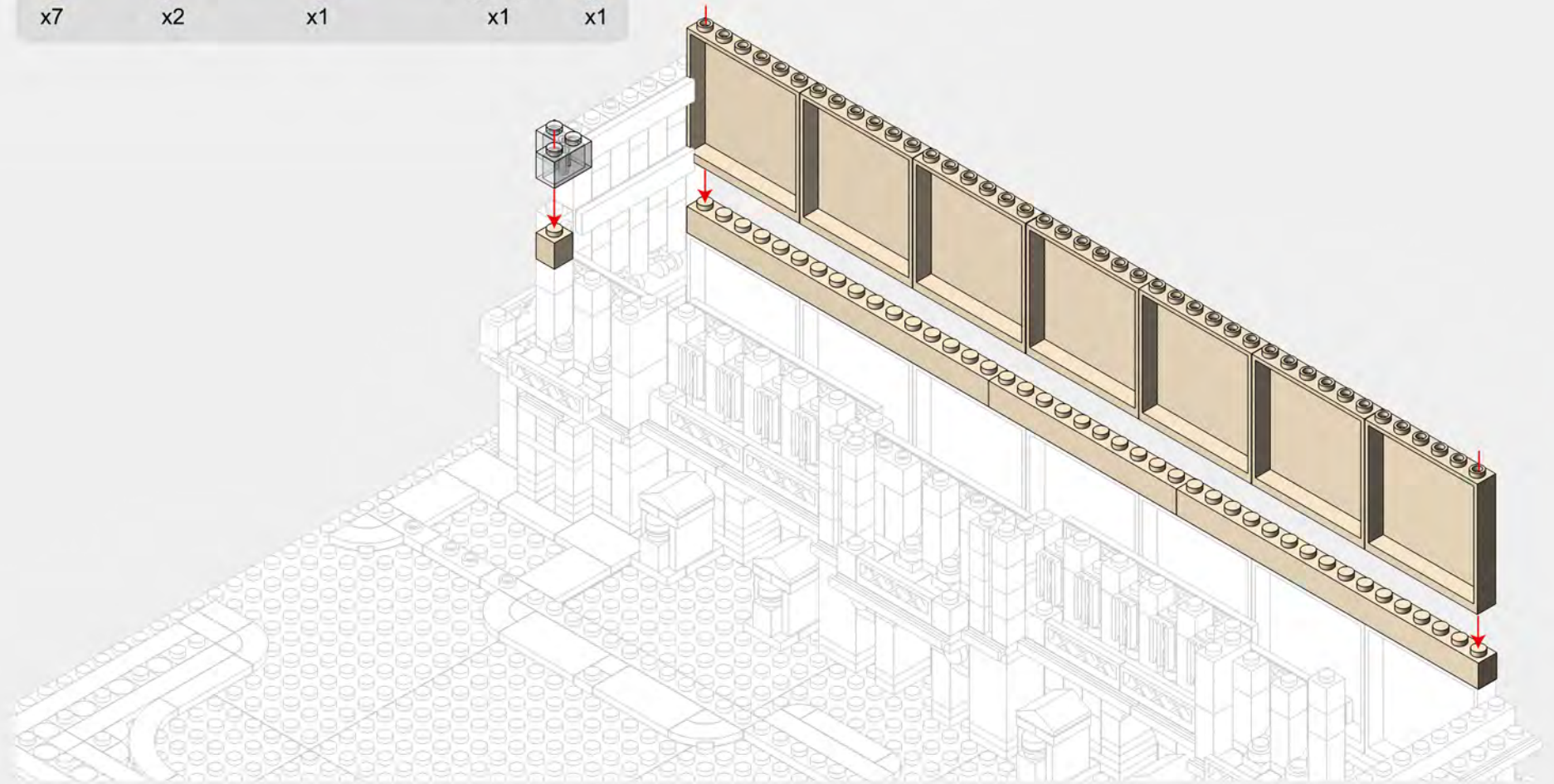
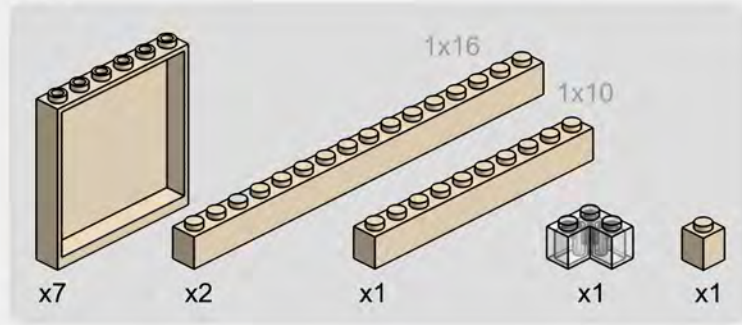

3-12

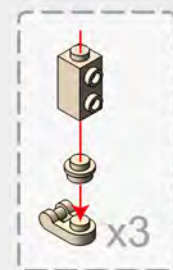
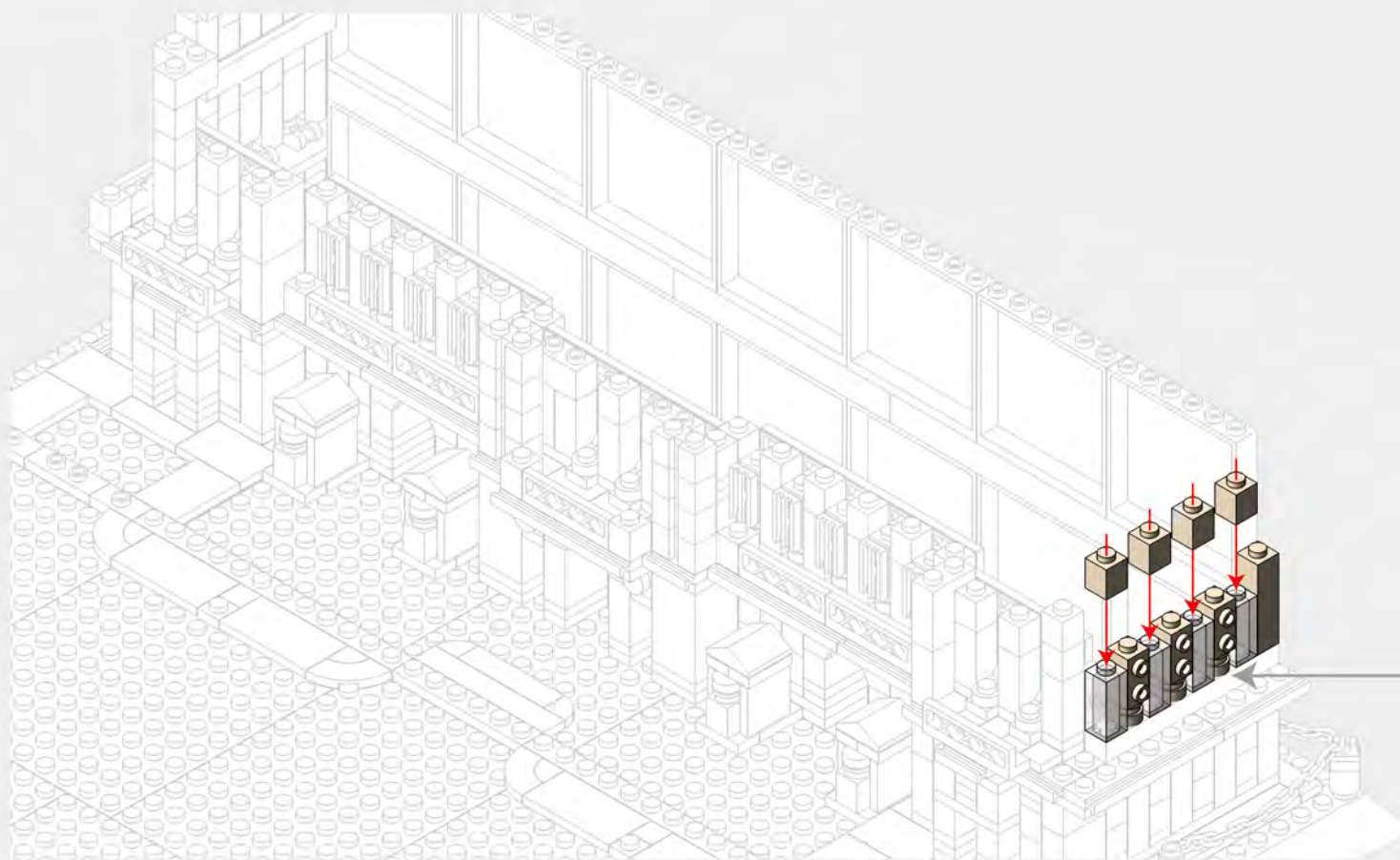
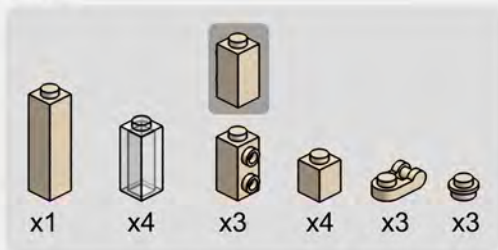

3-13

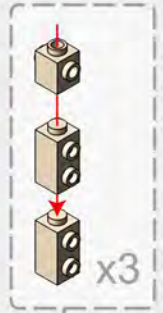
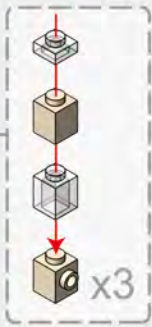
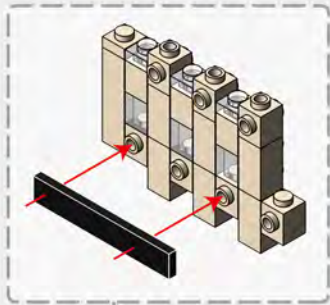
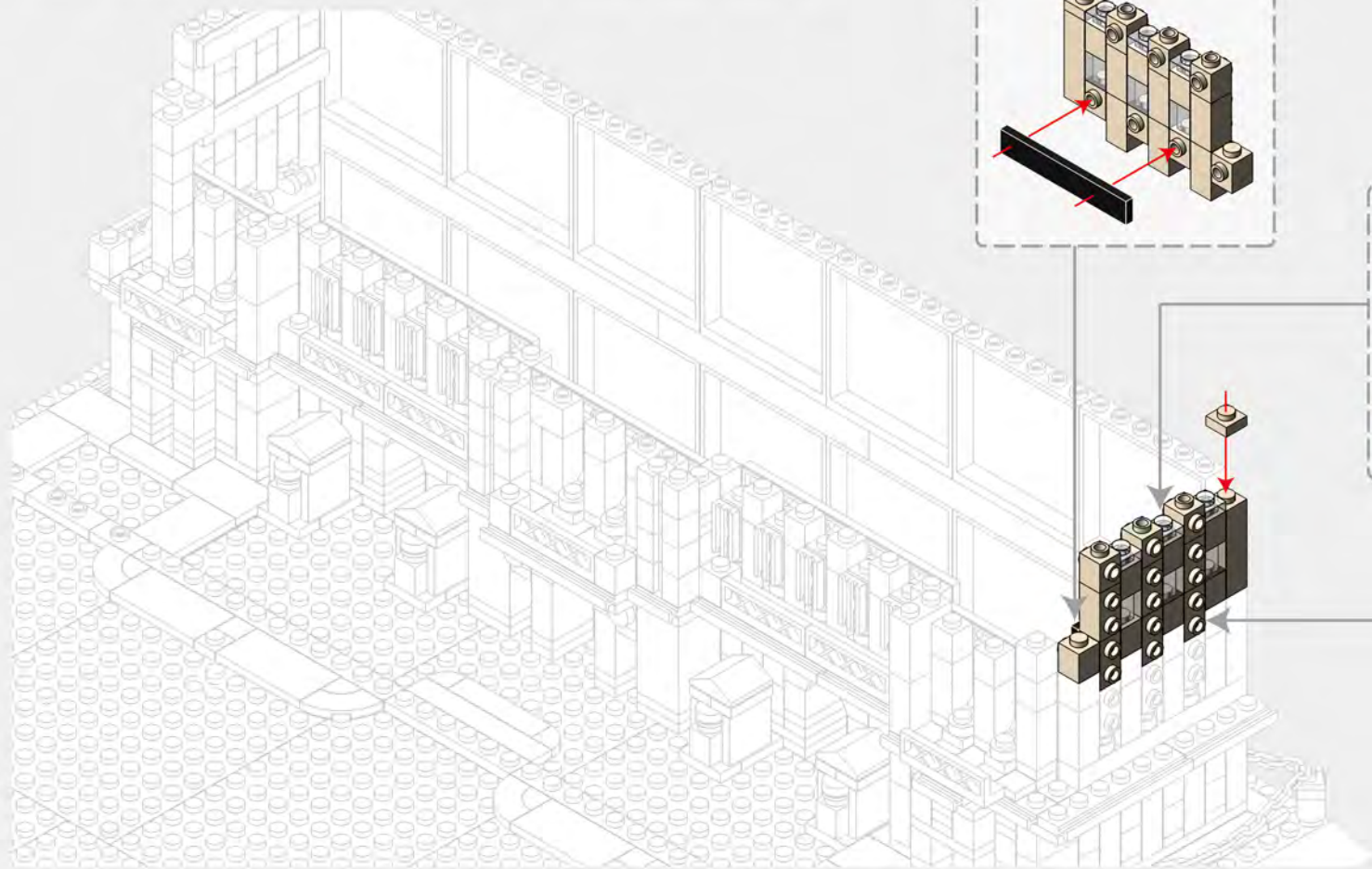
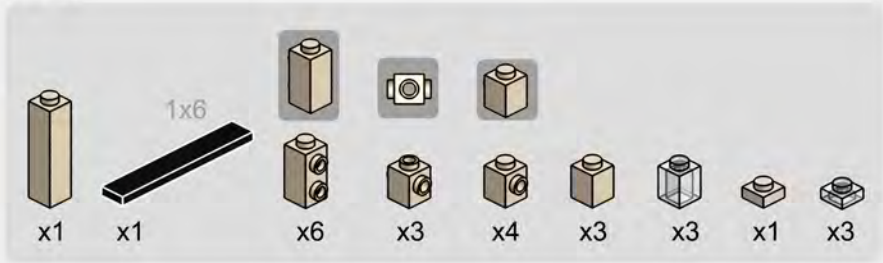

3-14



x2



x1



x3



x1



x2



x1

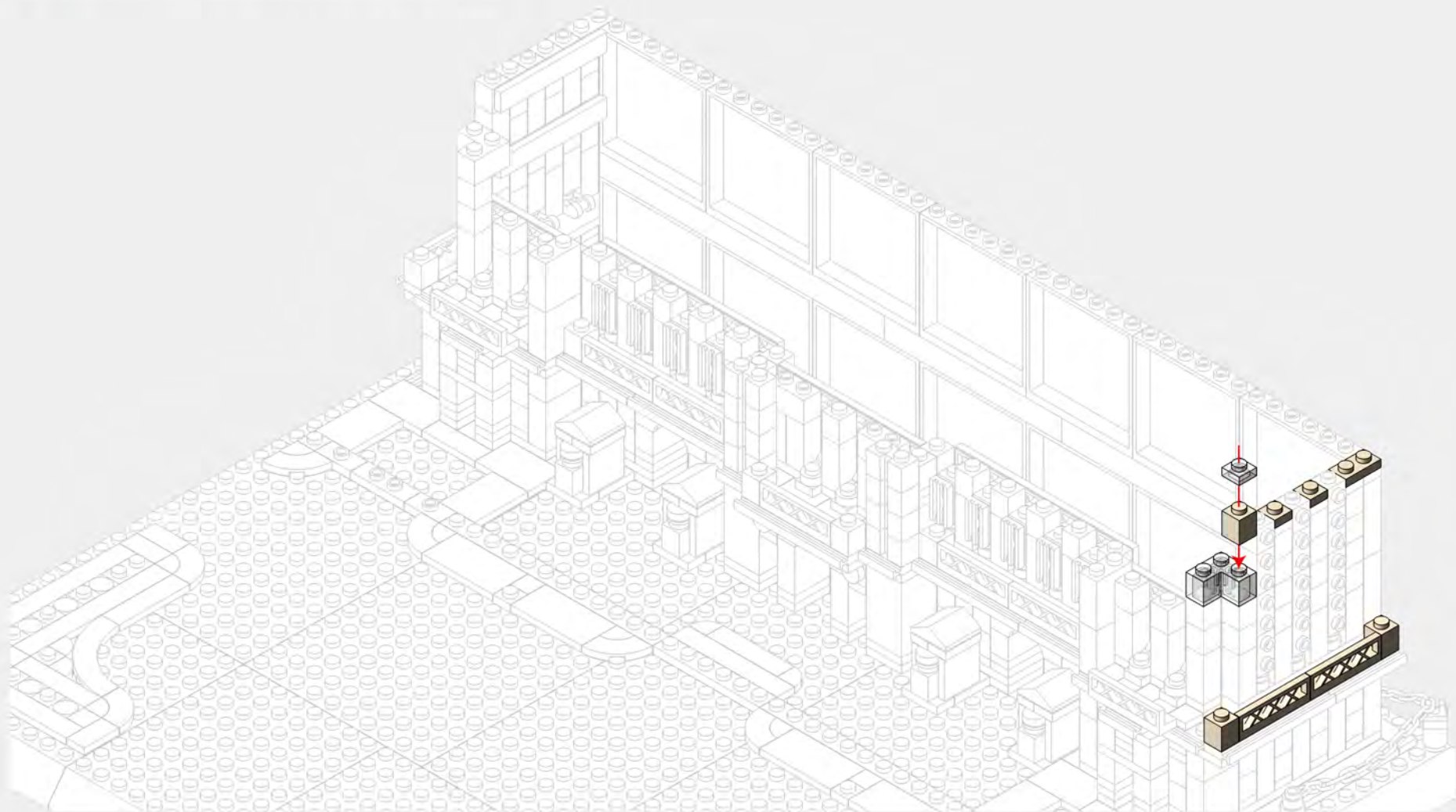



293PCS







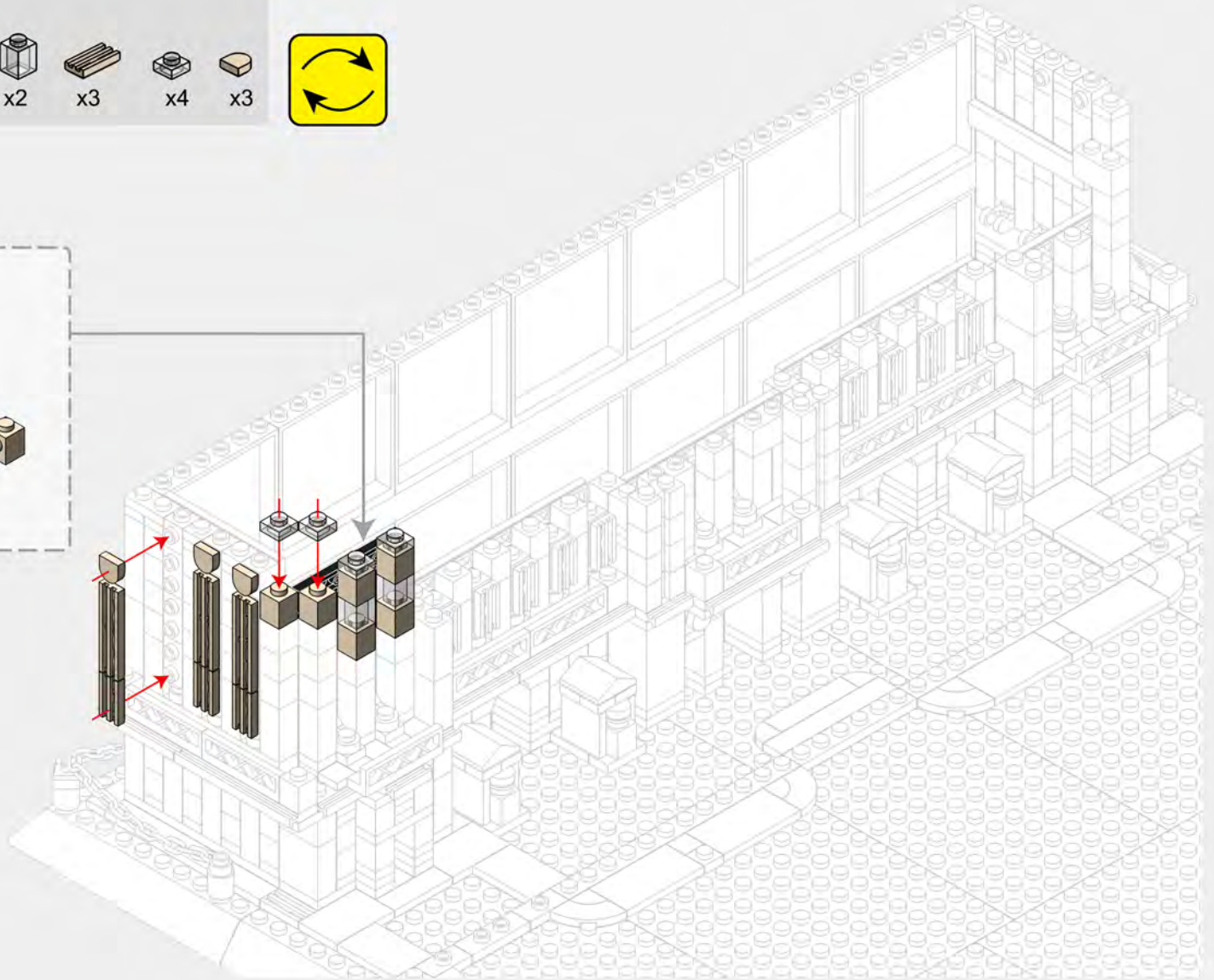
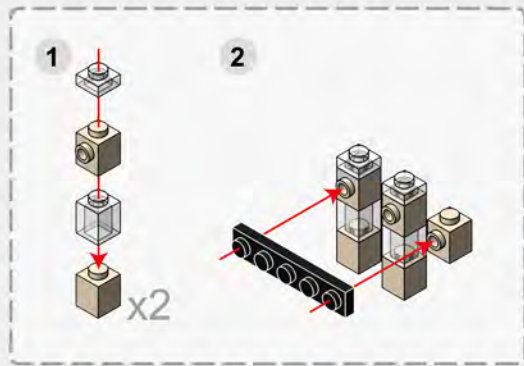
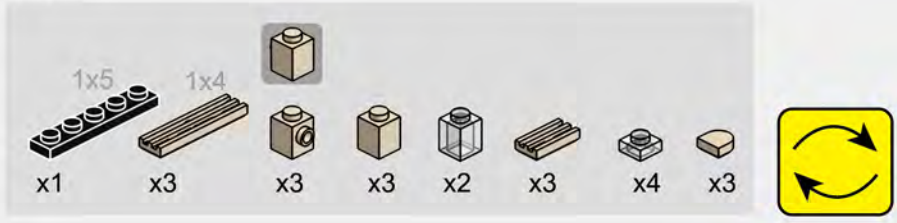



61

4-1



4-2

-  x4
-  x1
-  x6
-  x1
-  x2
-  x2
-  x1
-  x2
-  x2

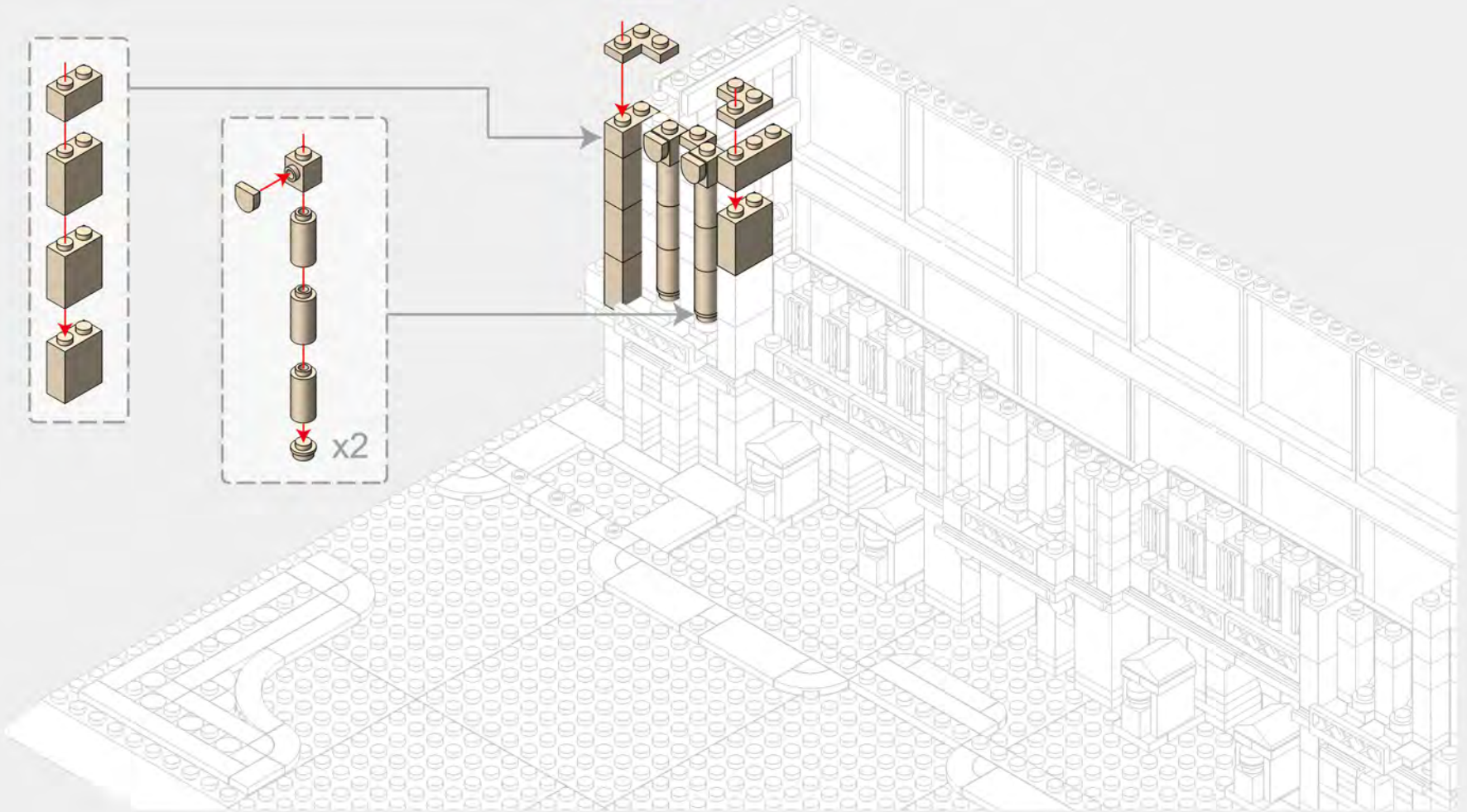

4-4

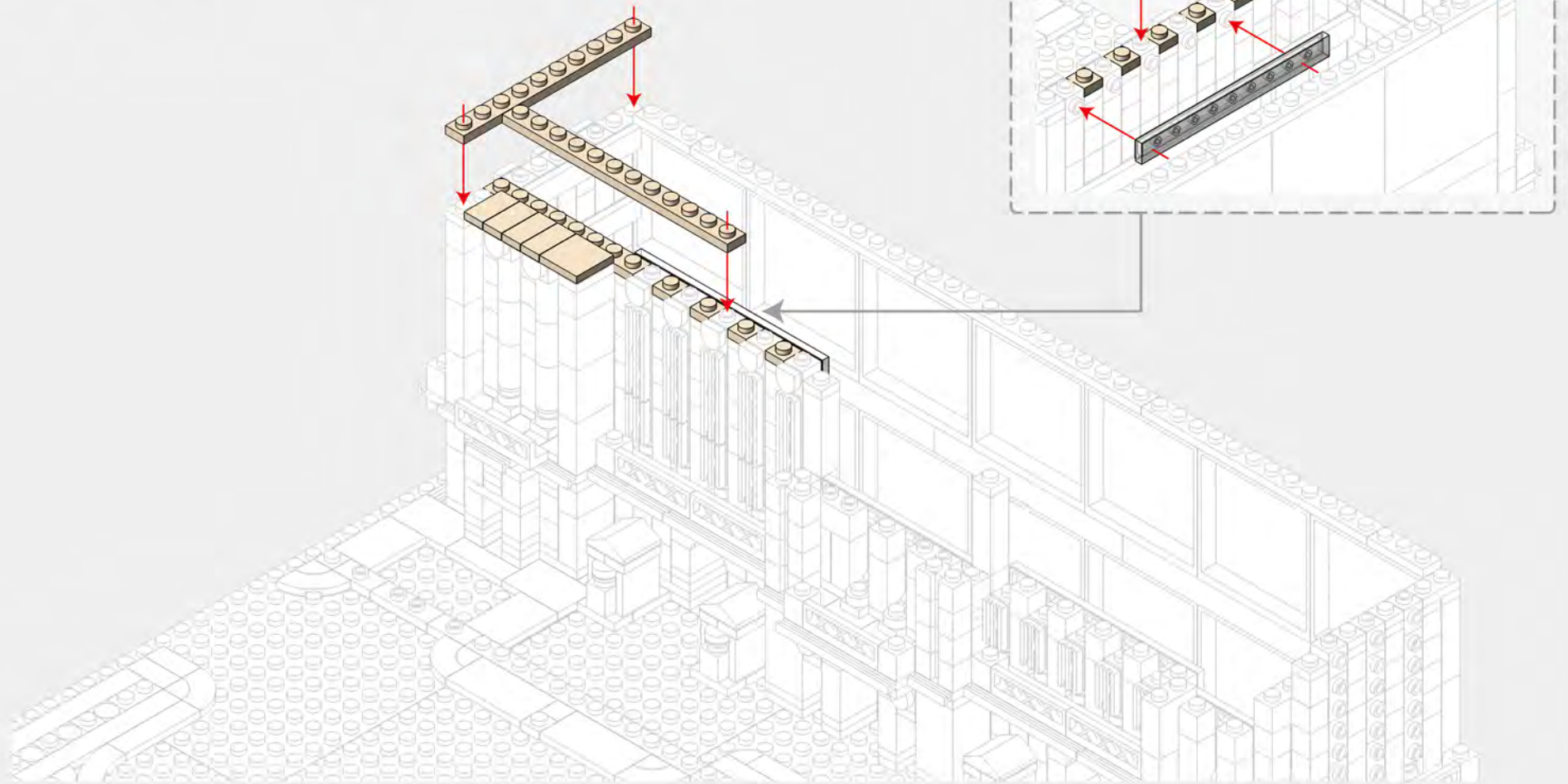
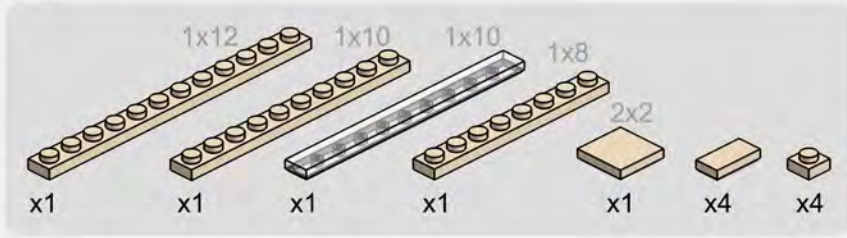

4-5

- 1x8
- x1
- x2
- x2
- x1
- x7
- x5
- x2
- x2
- x5

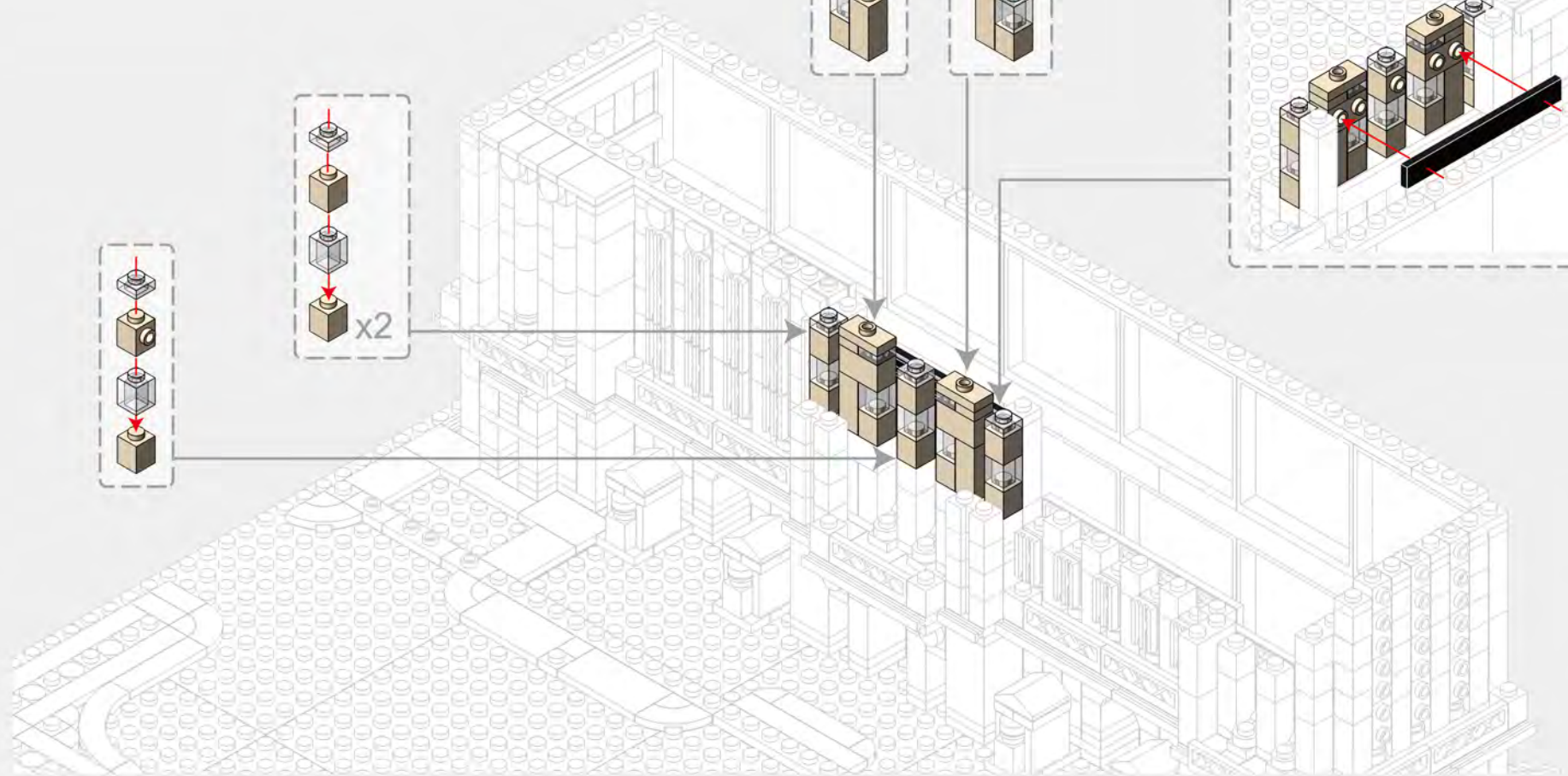
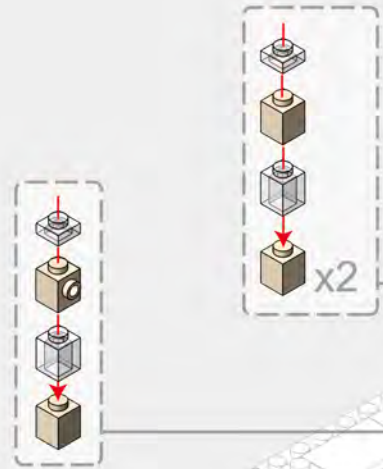
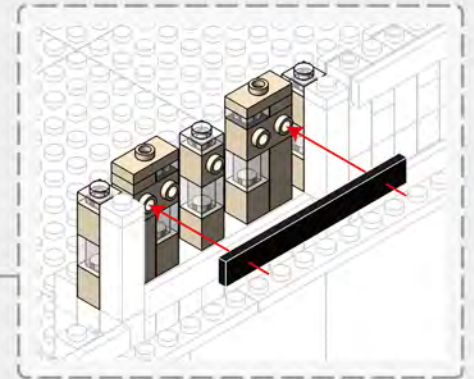
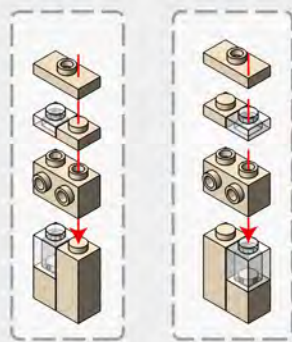

4-6

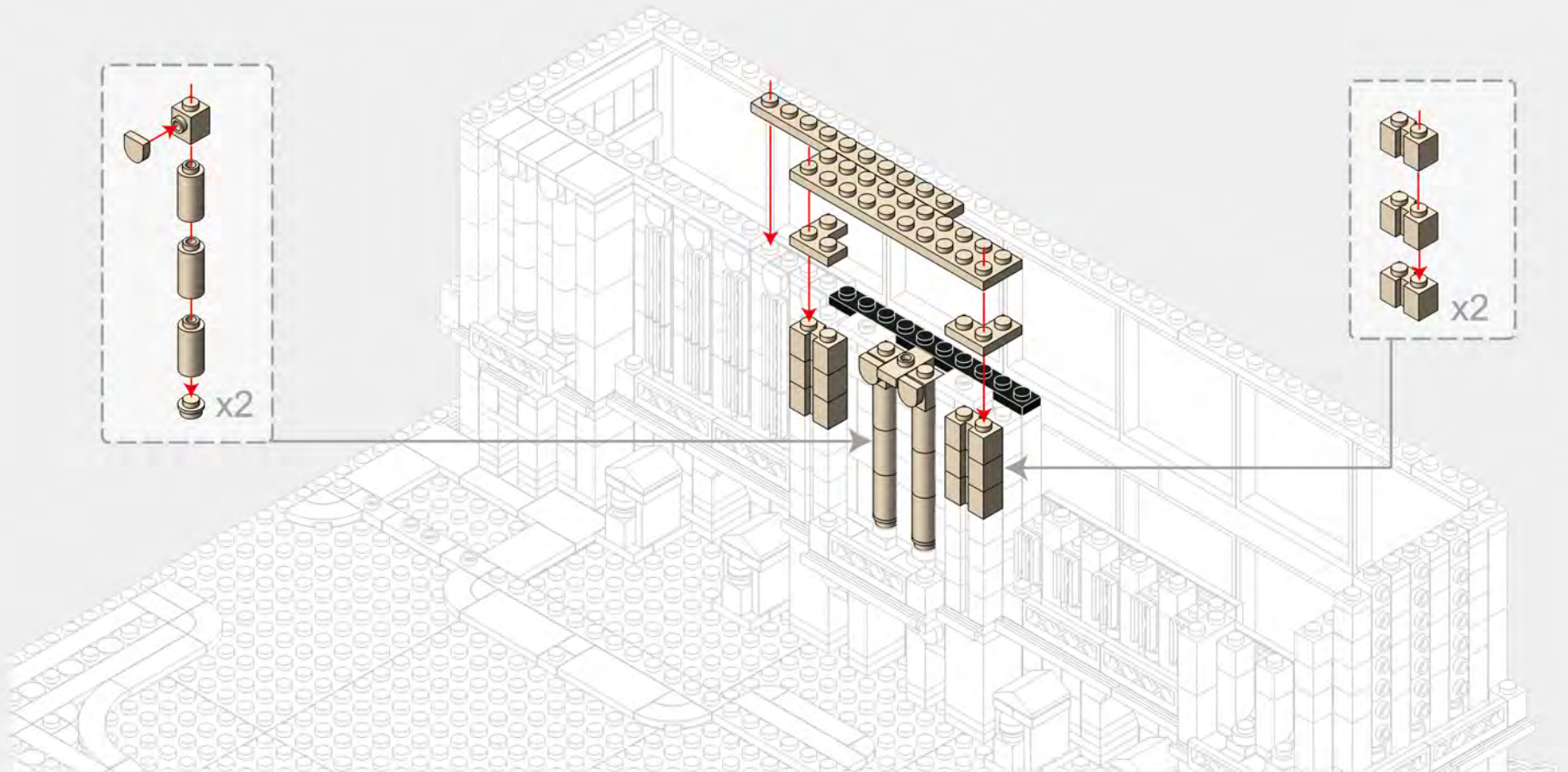
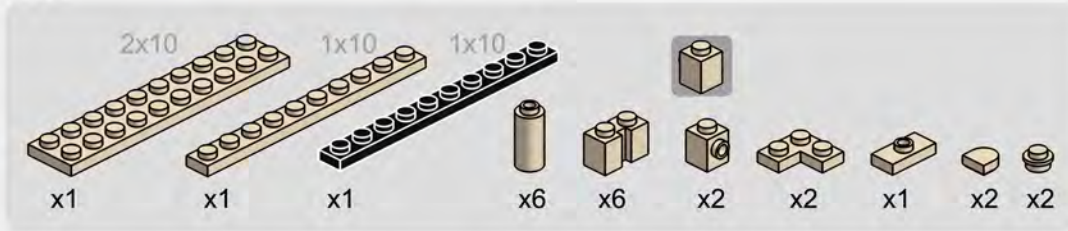

4-7

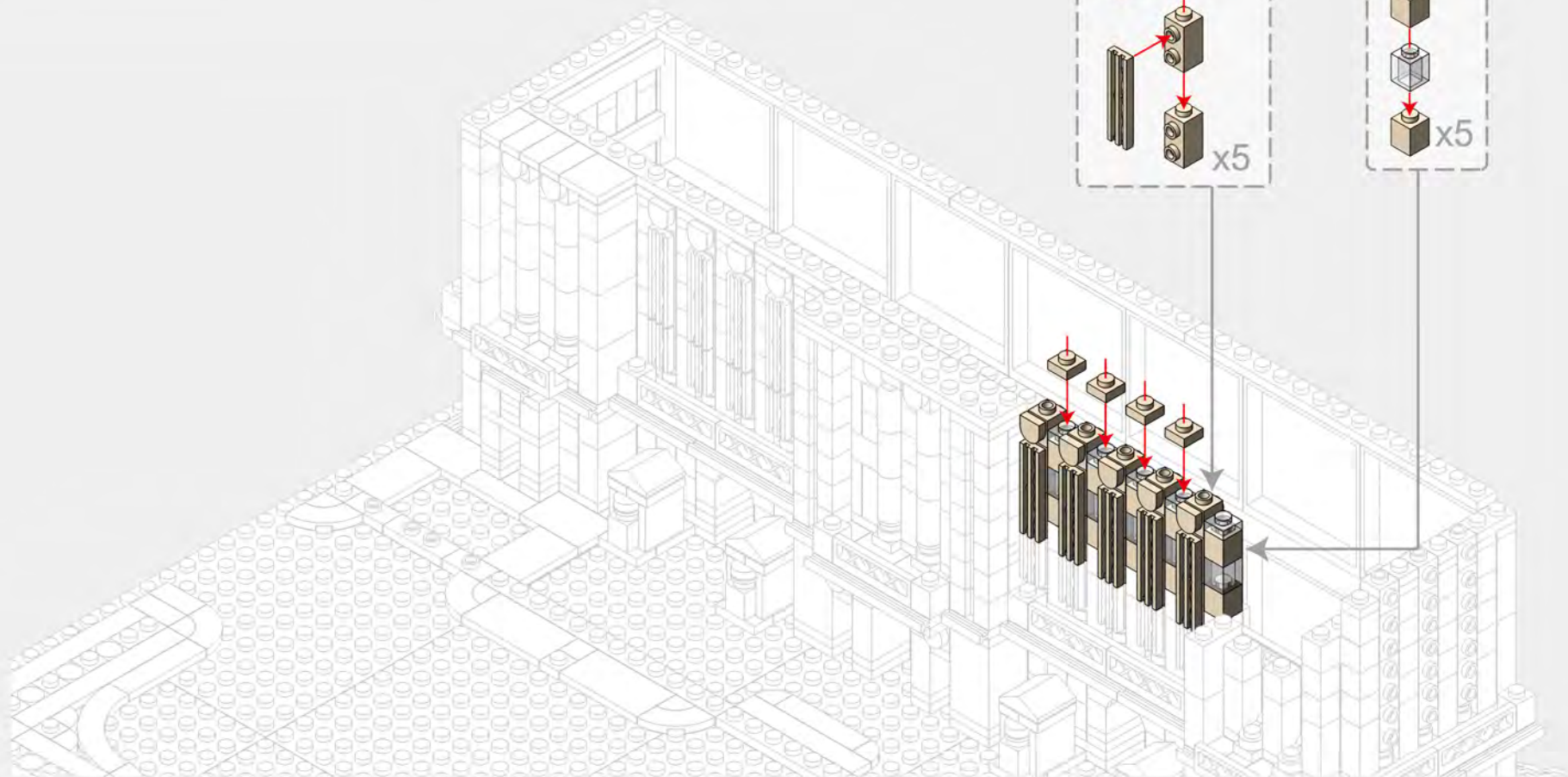

4-8

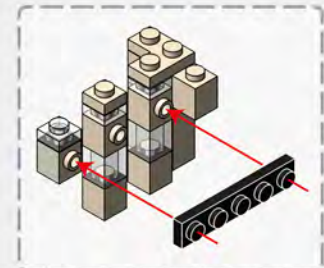
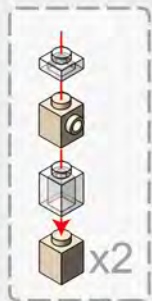
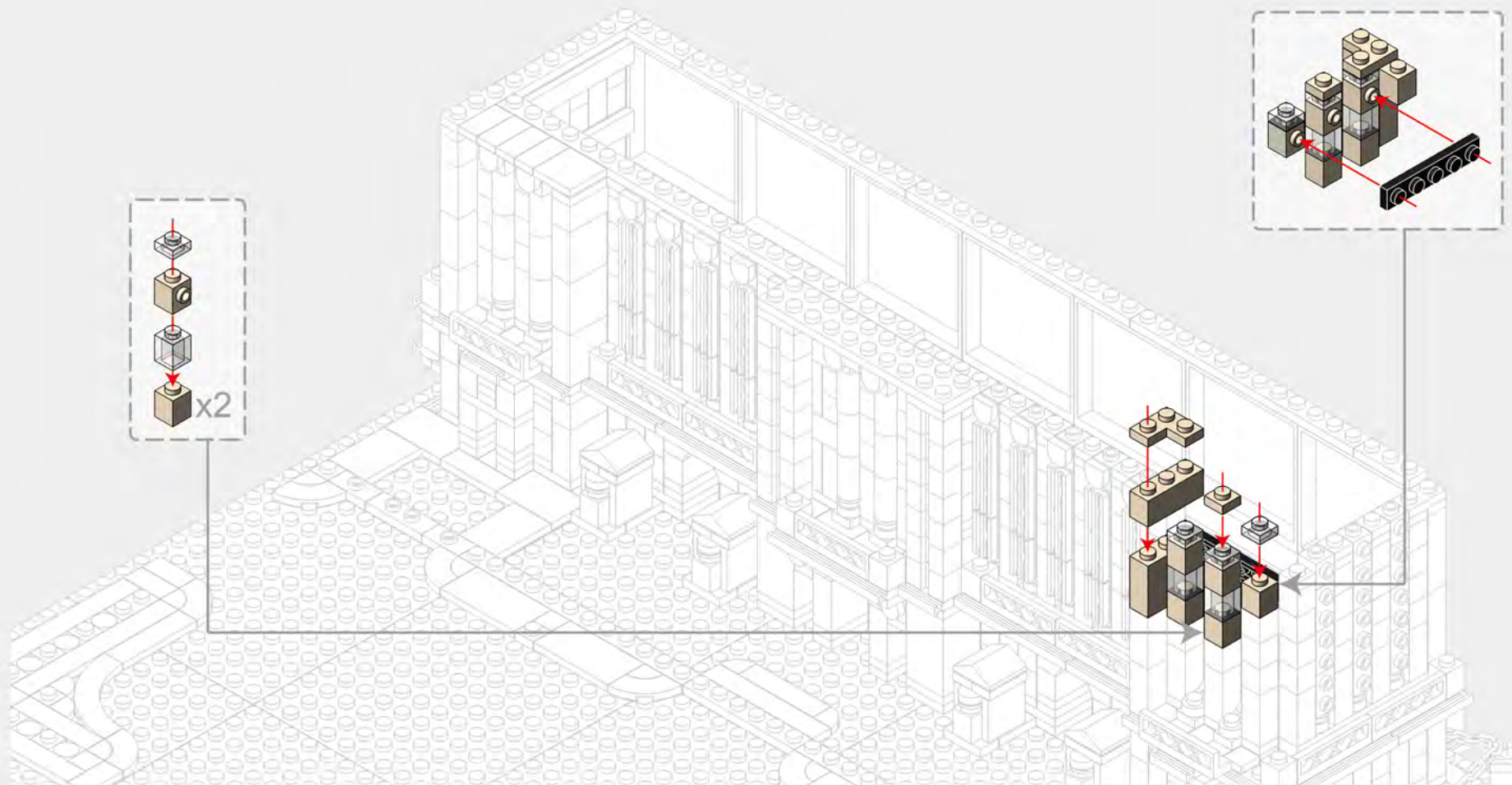

4-9

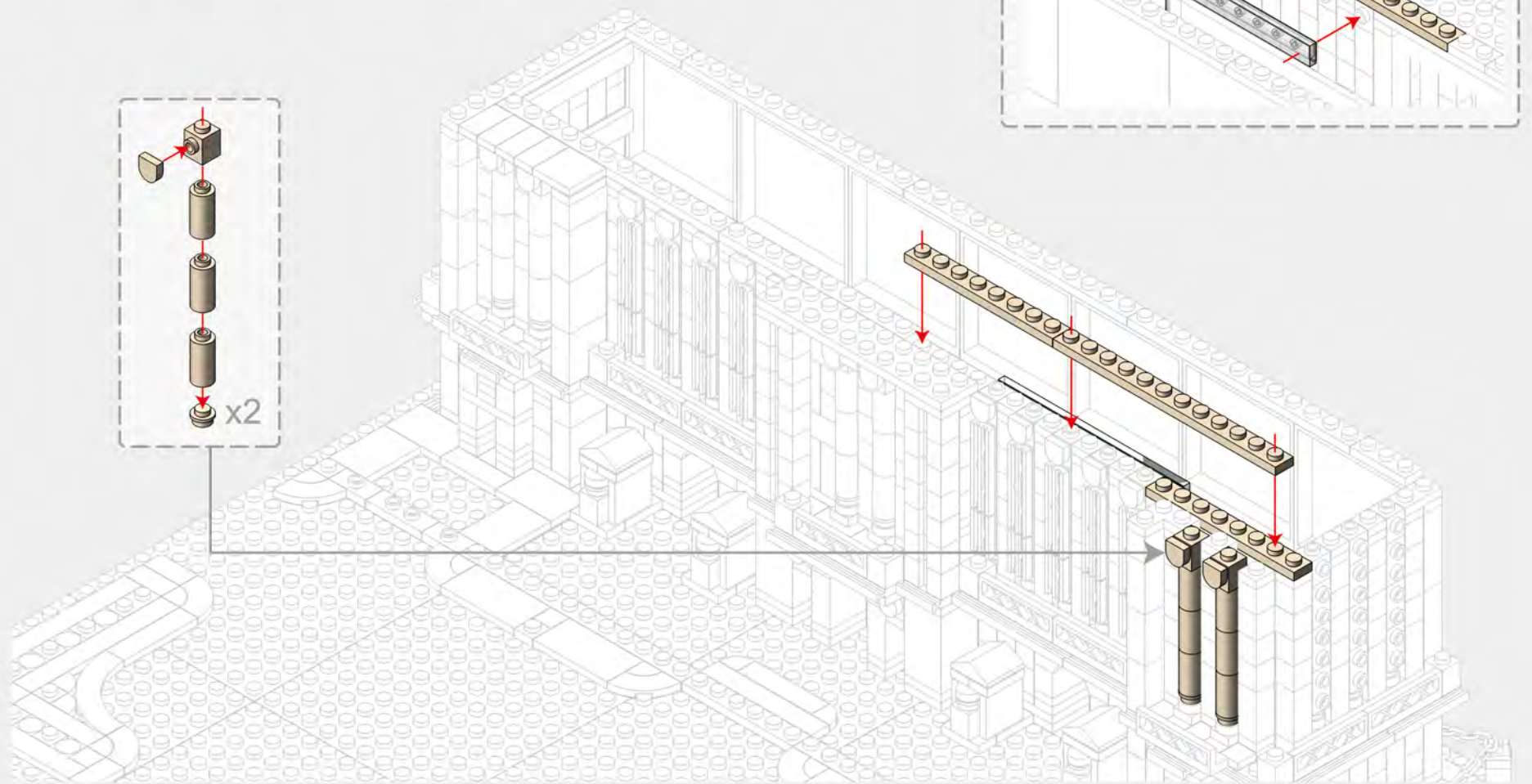
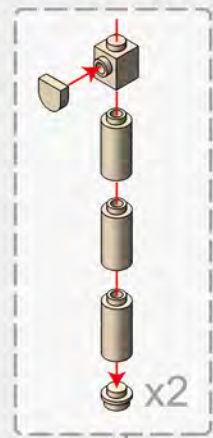
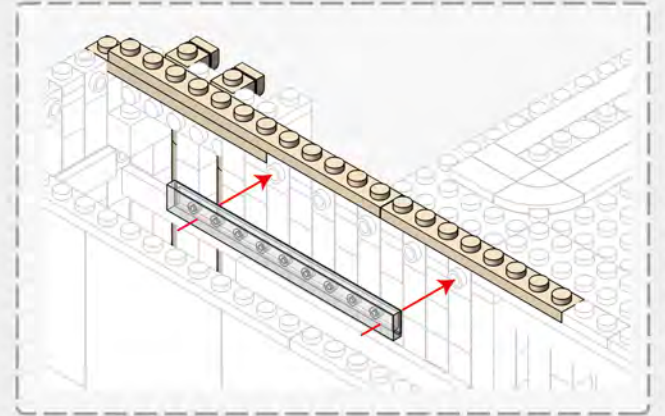
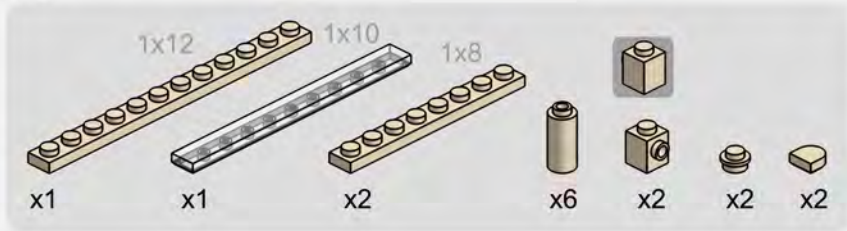

4-11

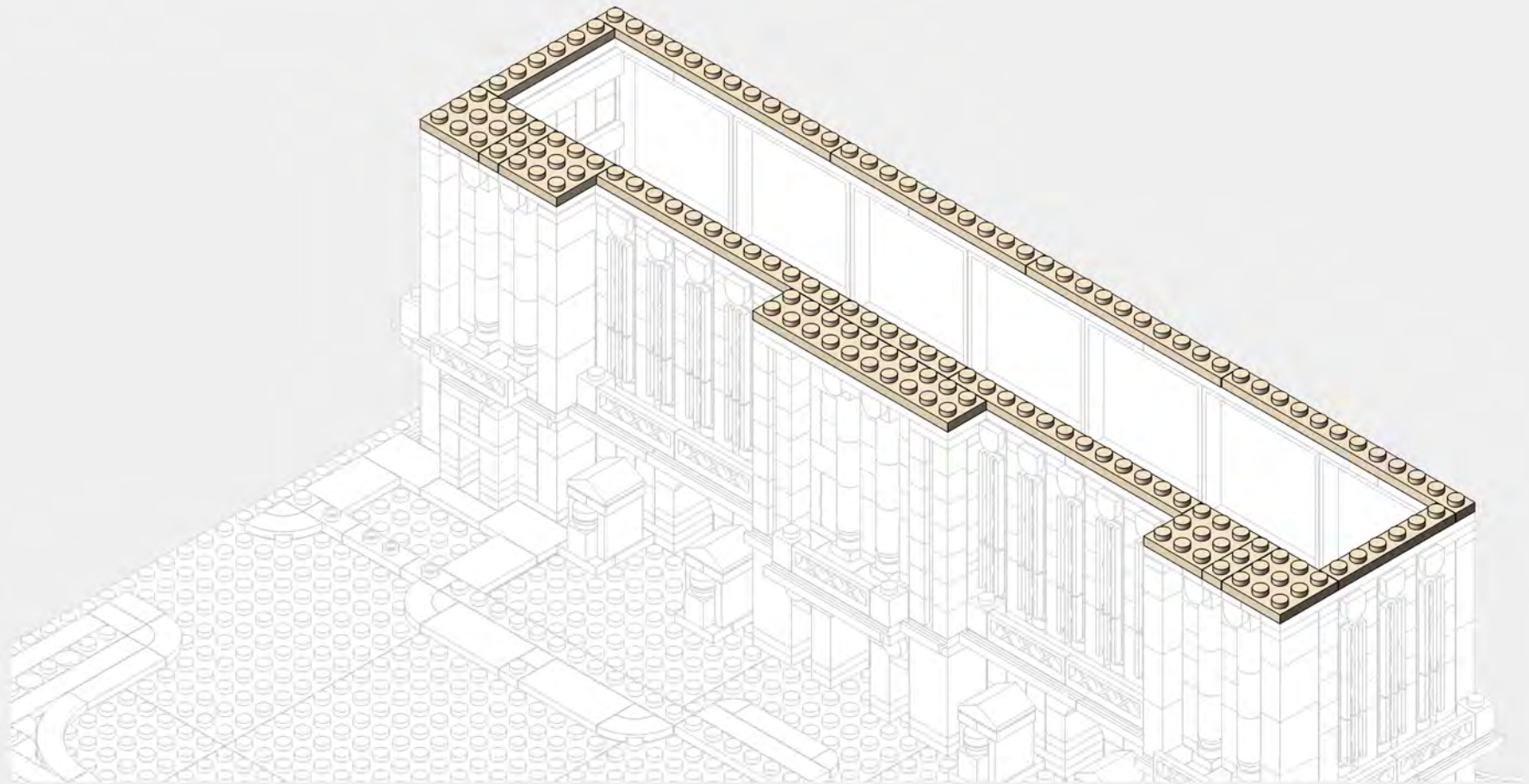
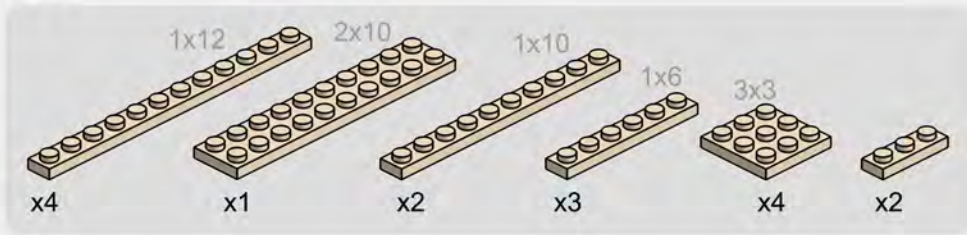

4-12

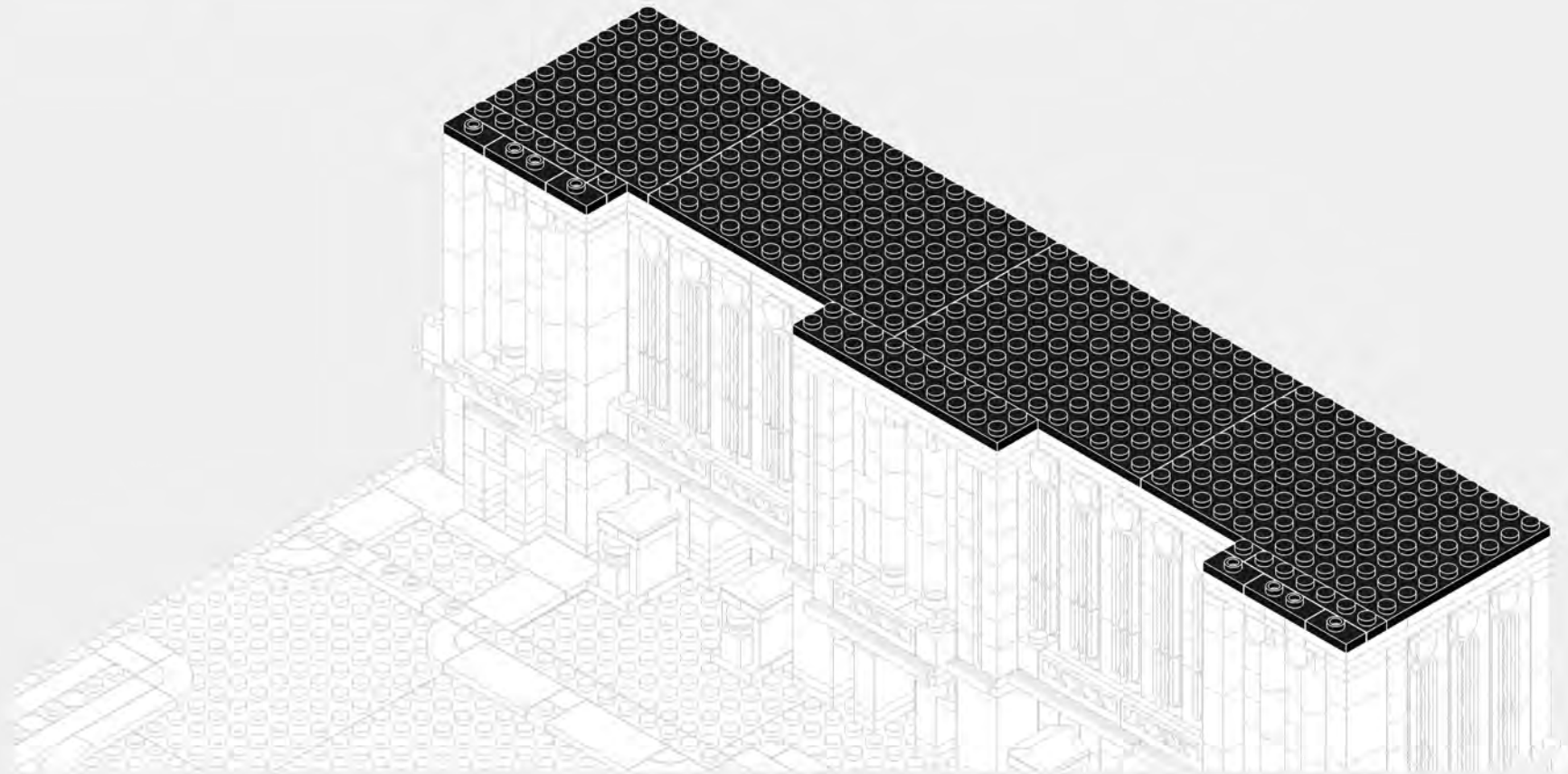
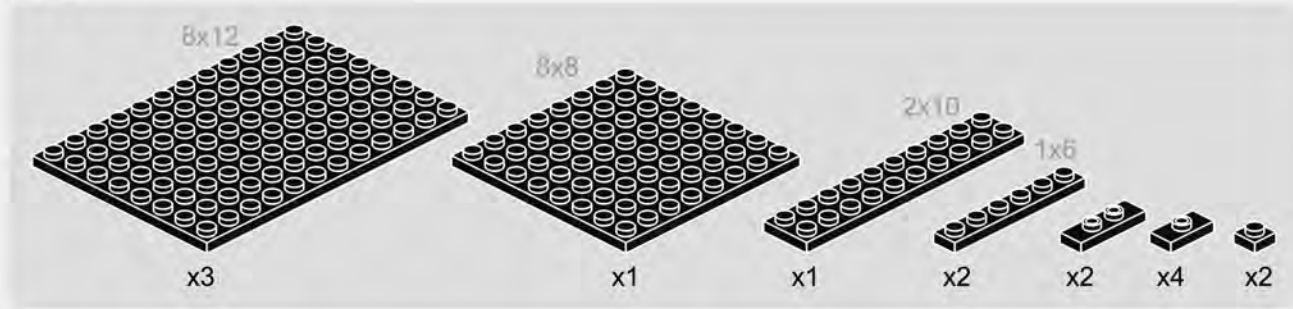



298PCS



74

5-2

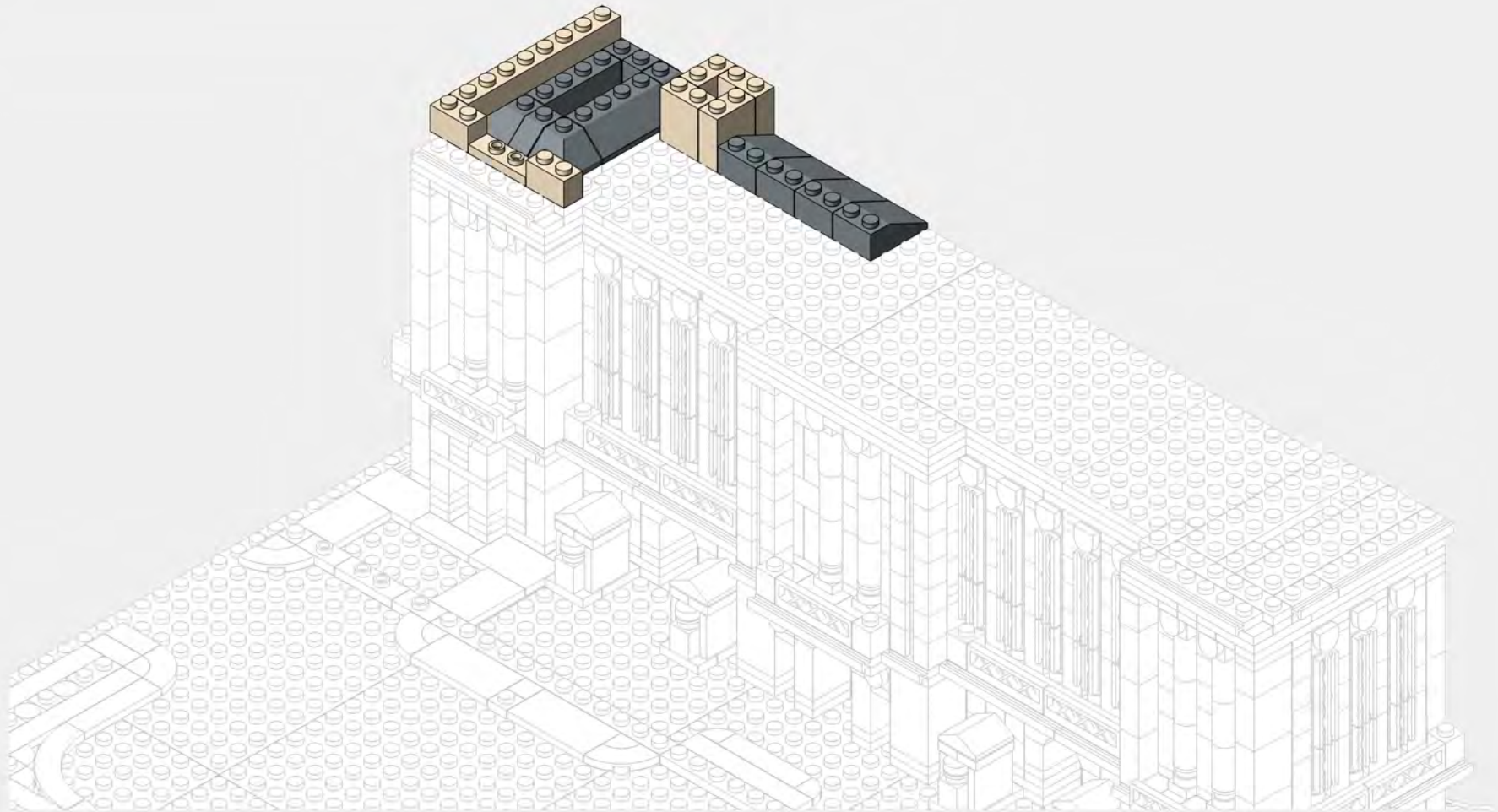
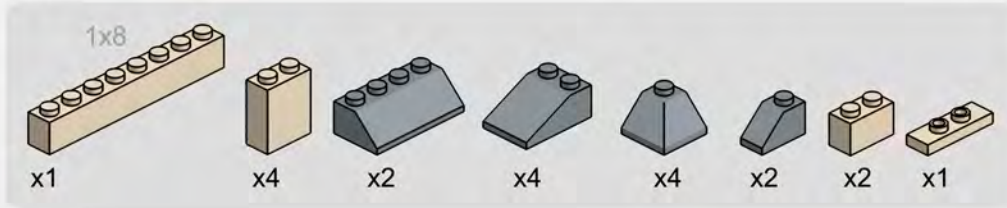

5-3

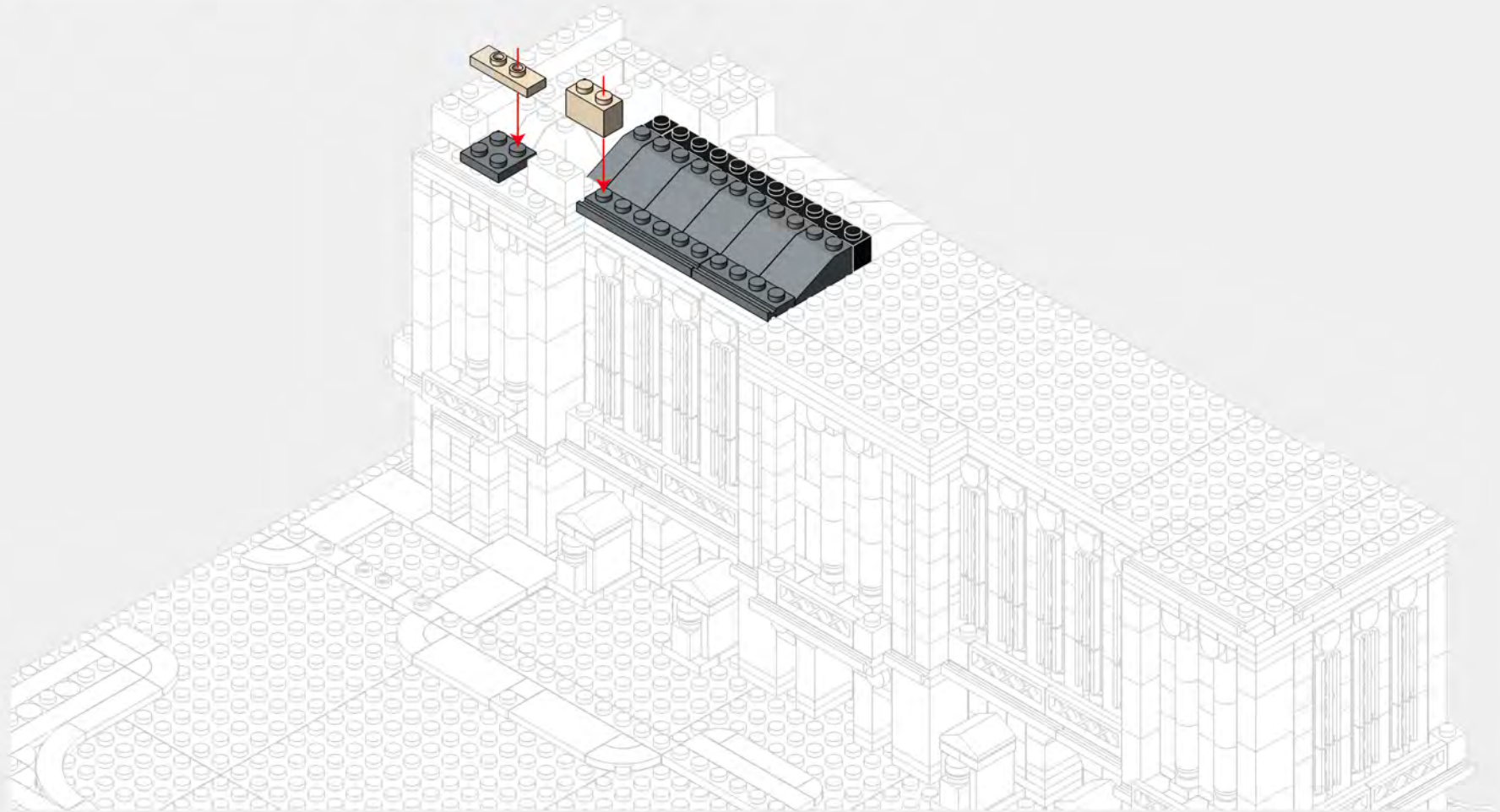
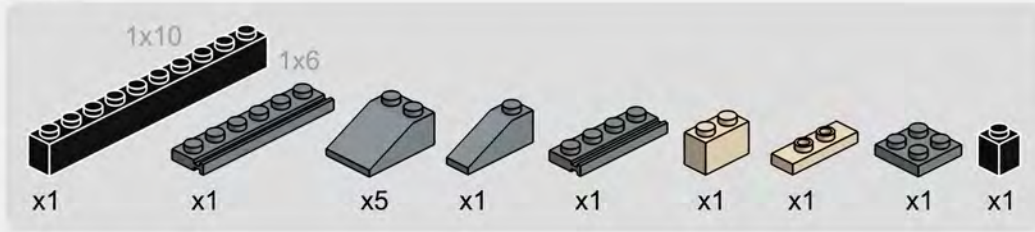

5-4

- 1x8 (tan) x1
- 1x6 (tan) x1
- 1x4 with axle (tan) x2
- 3x4 (dark grey) x1
- 2x3 (dark grey) x1
- 1x1 (tan) x1
- 1x2 (tan) x1
- 1x4 (tan) x4
- 1x2 (dark grey) x1
- 1x2 (dark grey) x4
- 1x1 (dark grey) x2

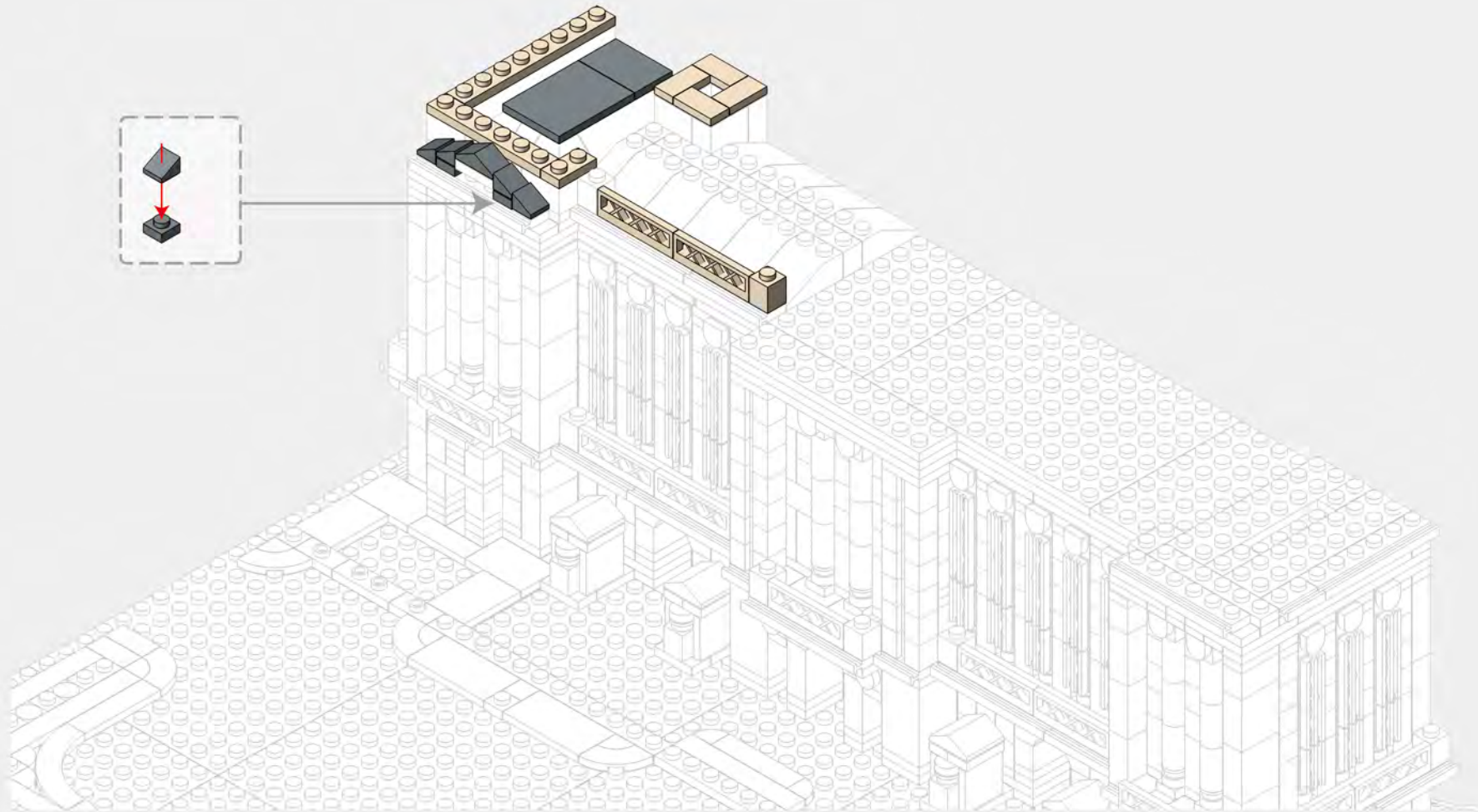

5-5

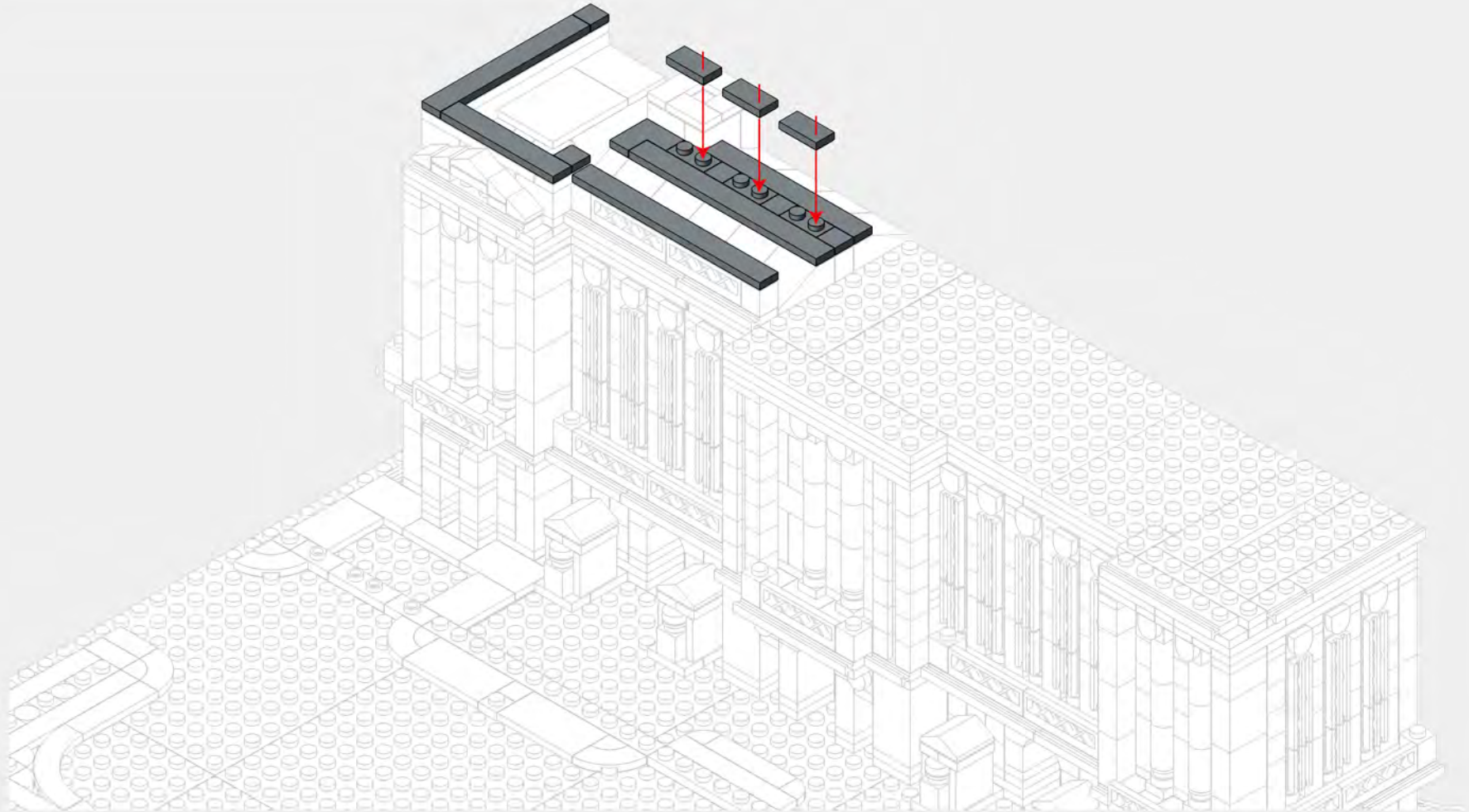
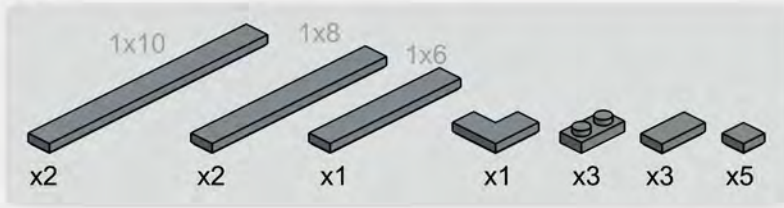

5-6

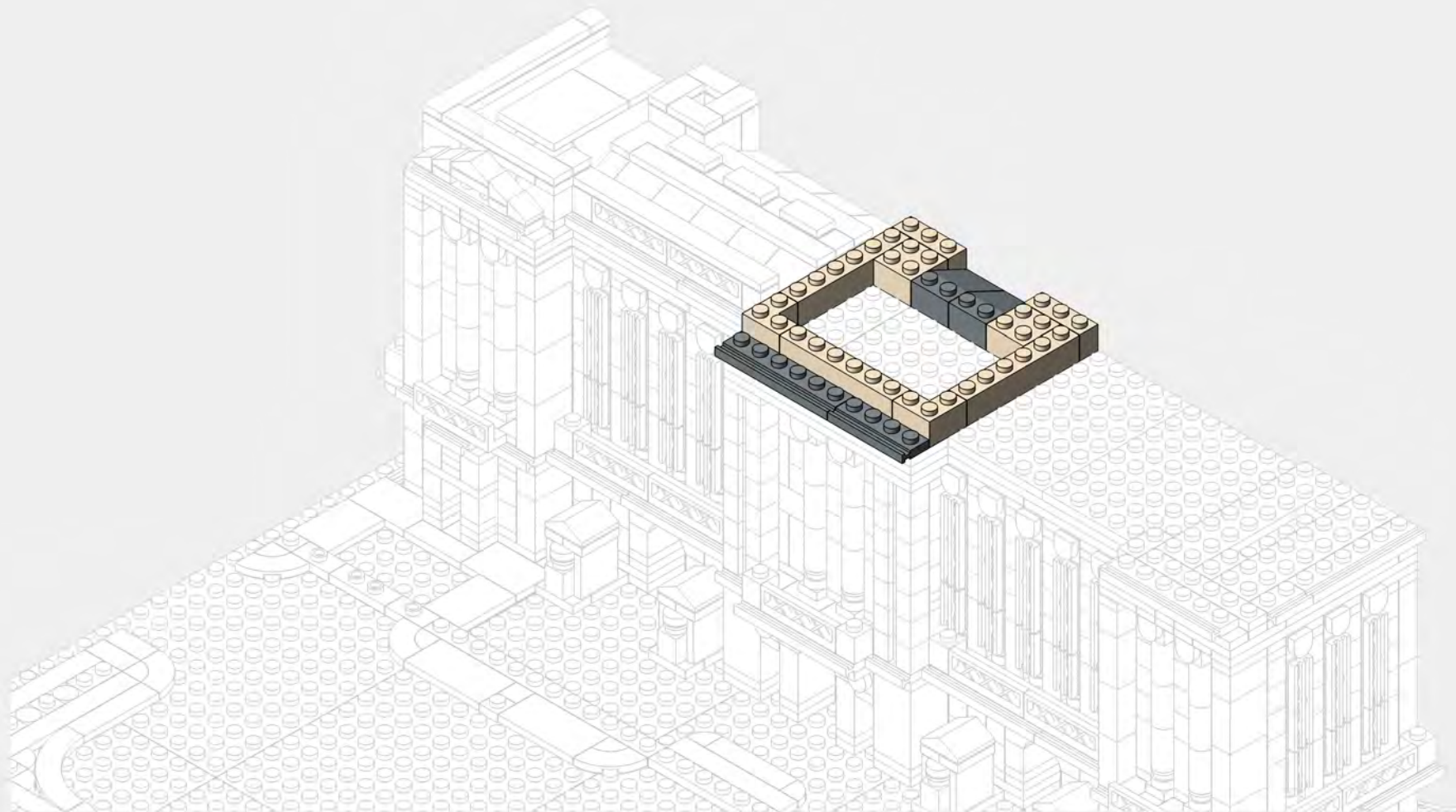
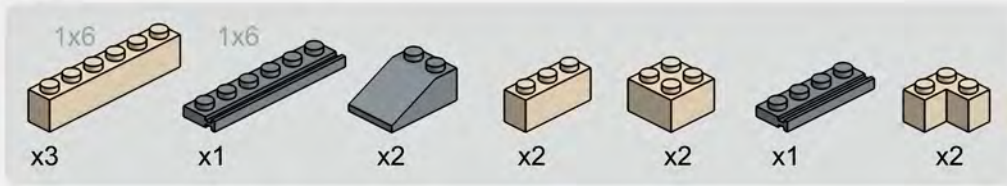

5-7

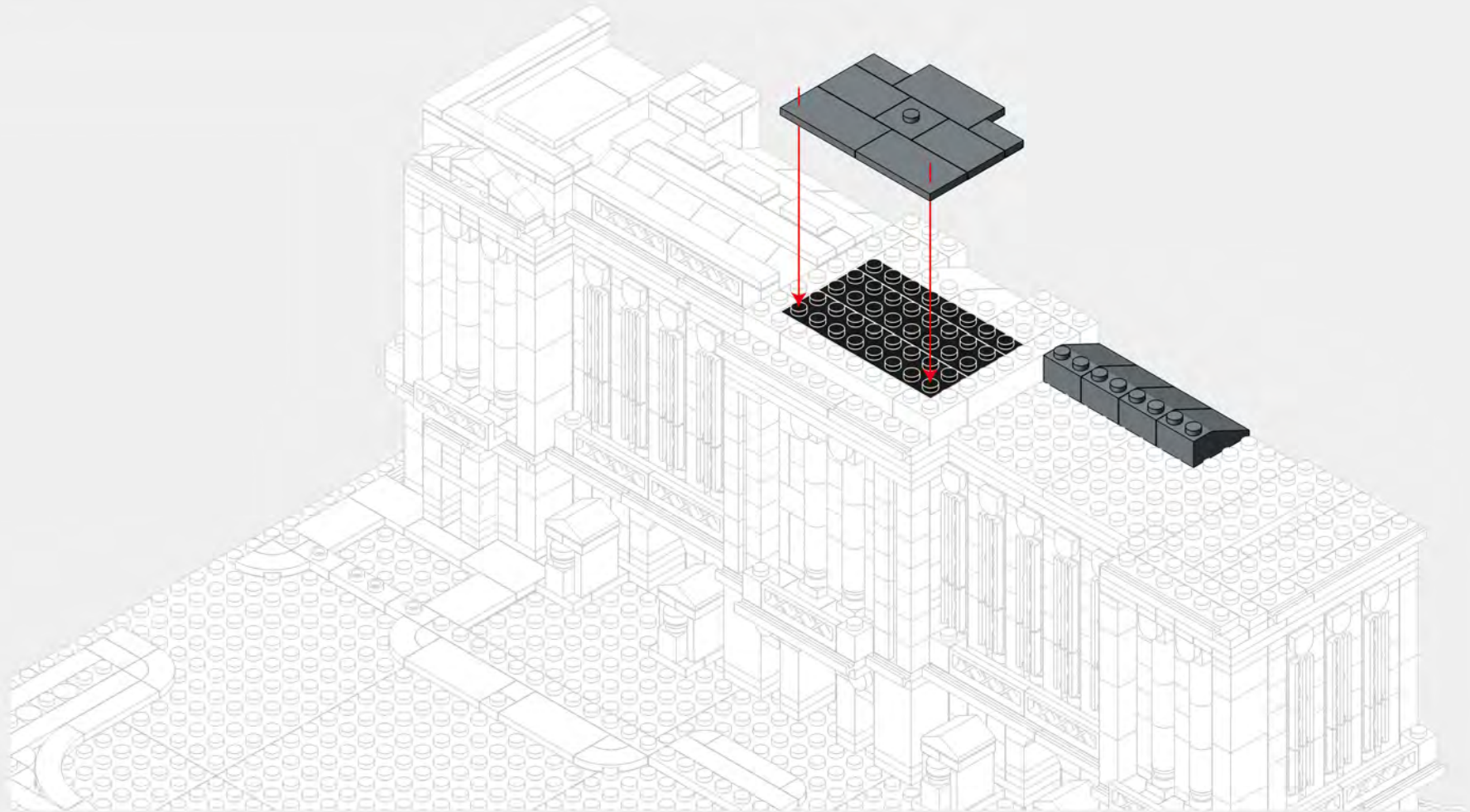
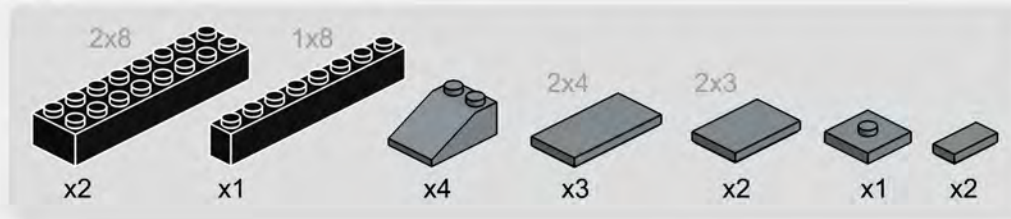

5-9

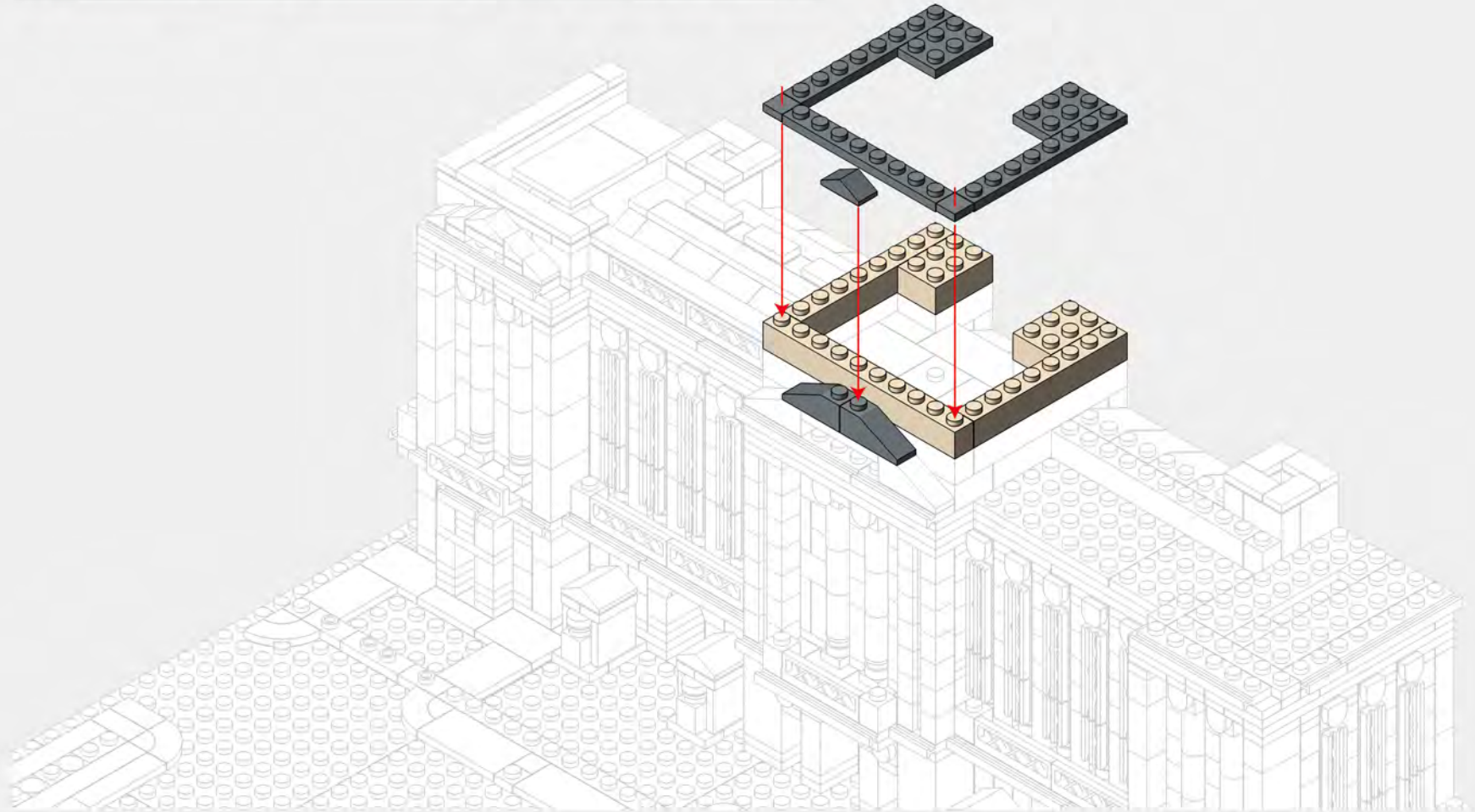
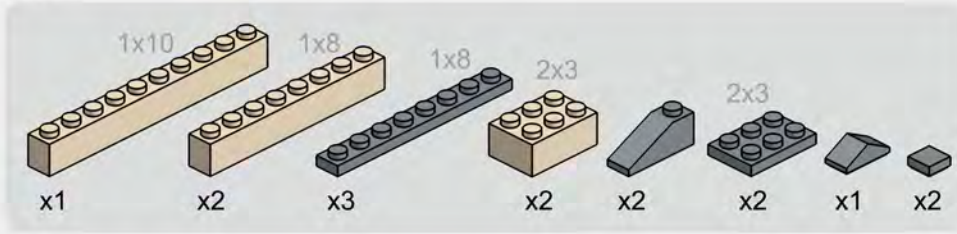

5-10

- 1x6 x3
- x5
- x1
- x1
- 2x2 x2
- 1x3 x2
- 1x3 x2
- x1
- x1
- x2

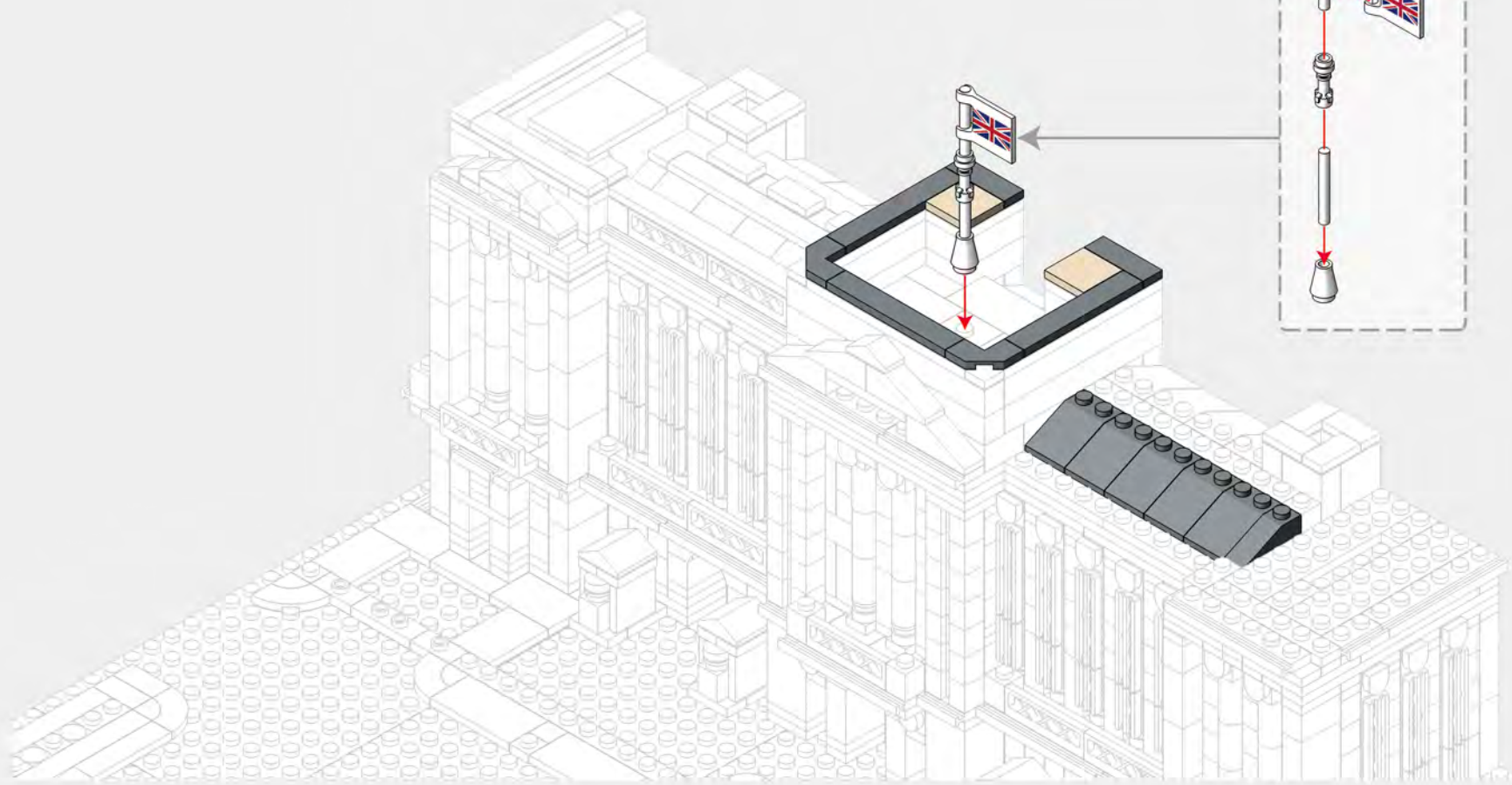

5-11

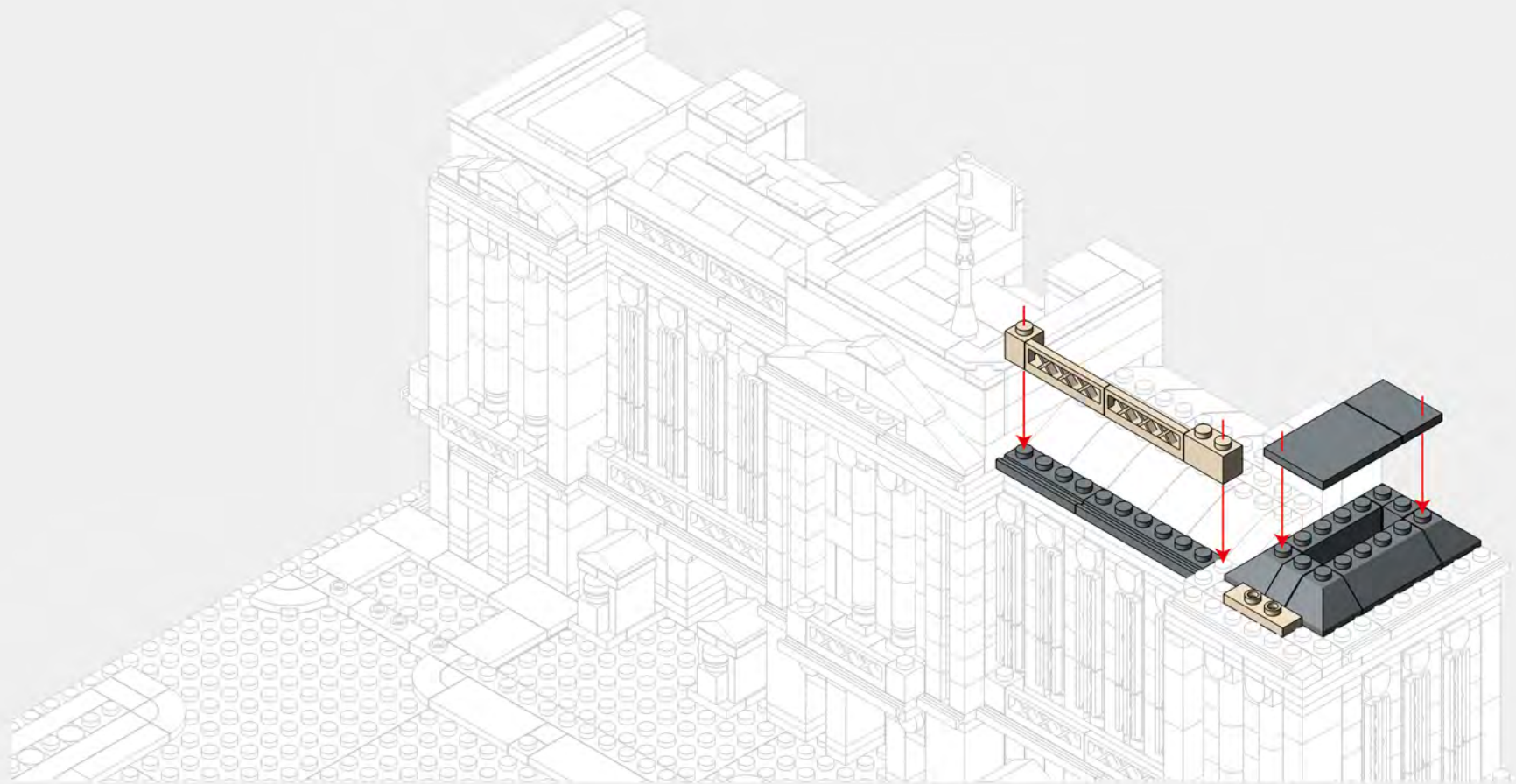

5-12

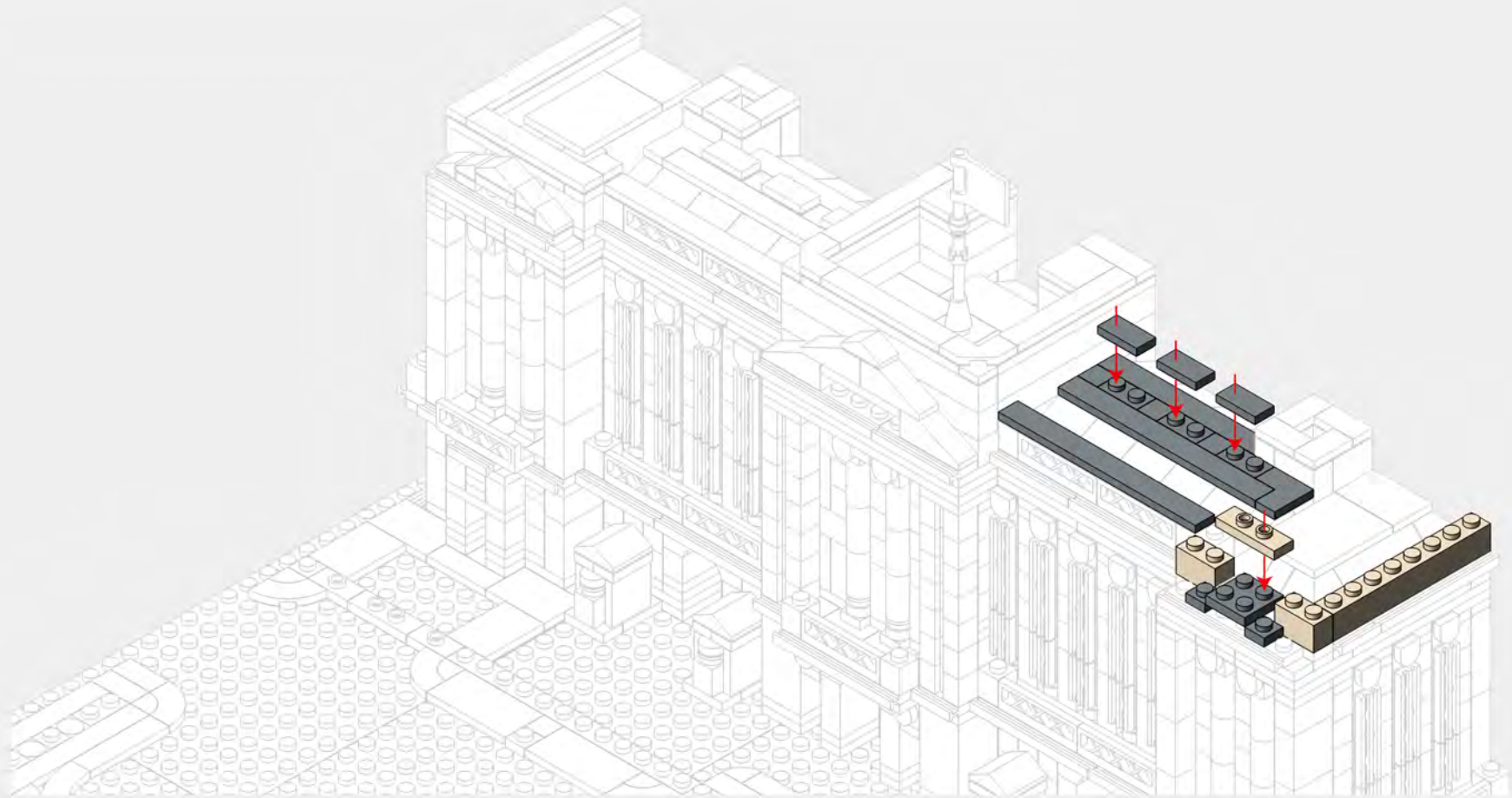
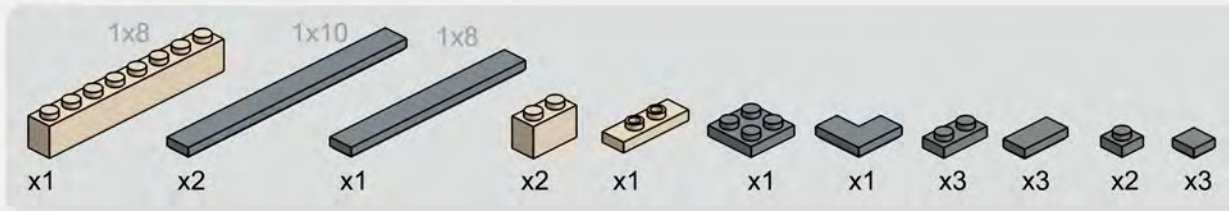

5-13

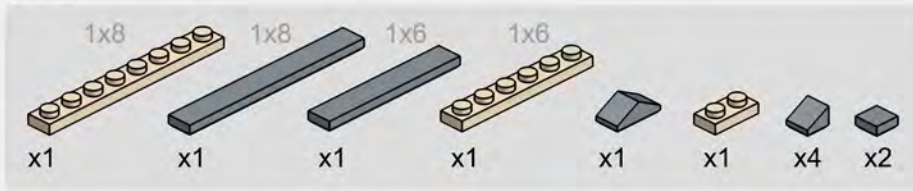

5-14

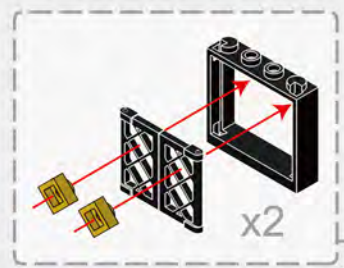
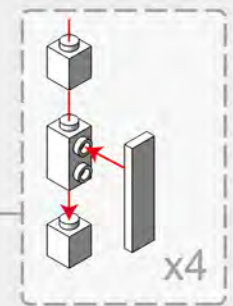
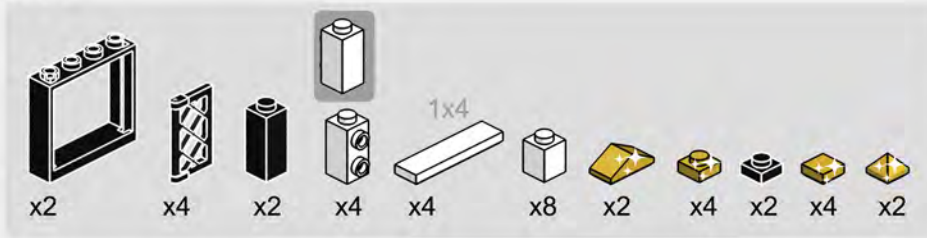

5-15

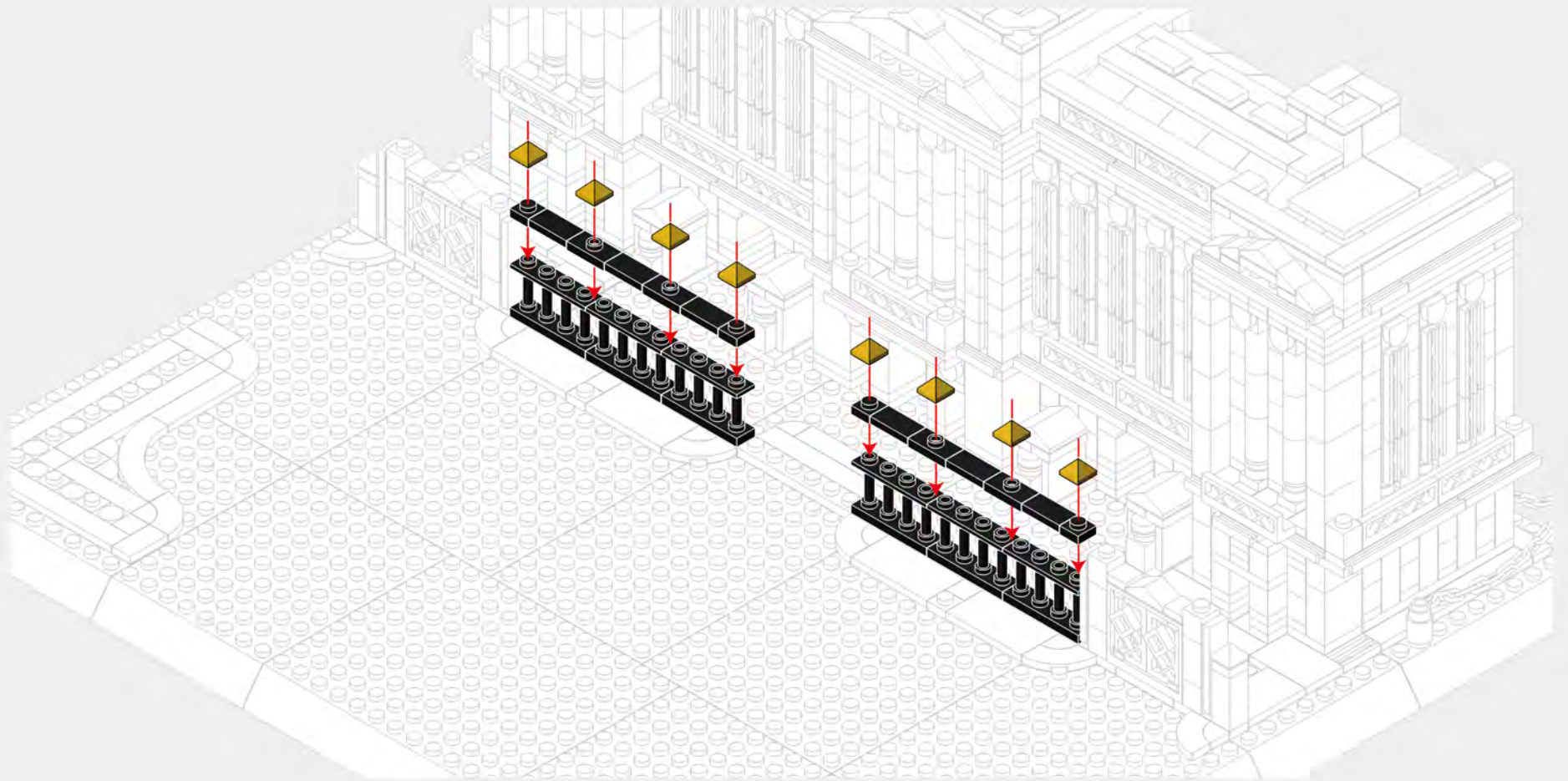
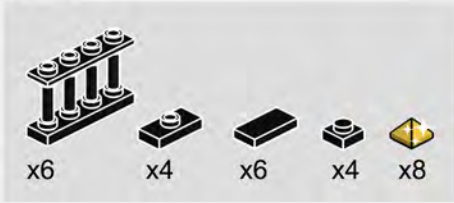

5-16

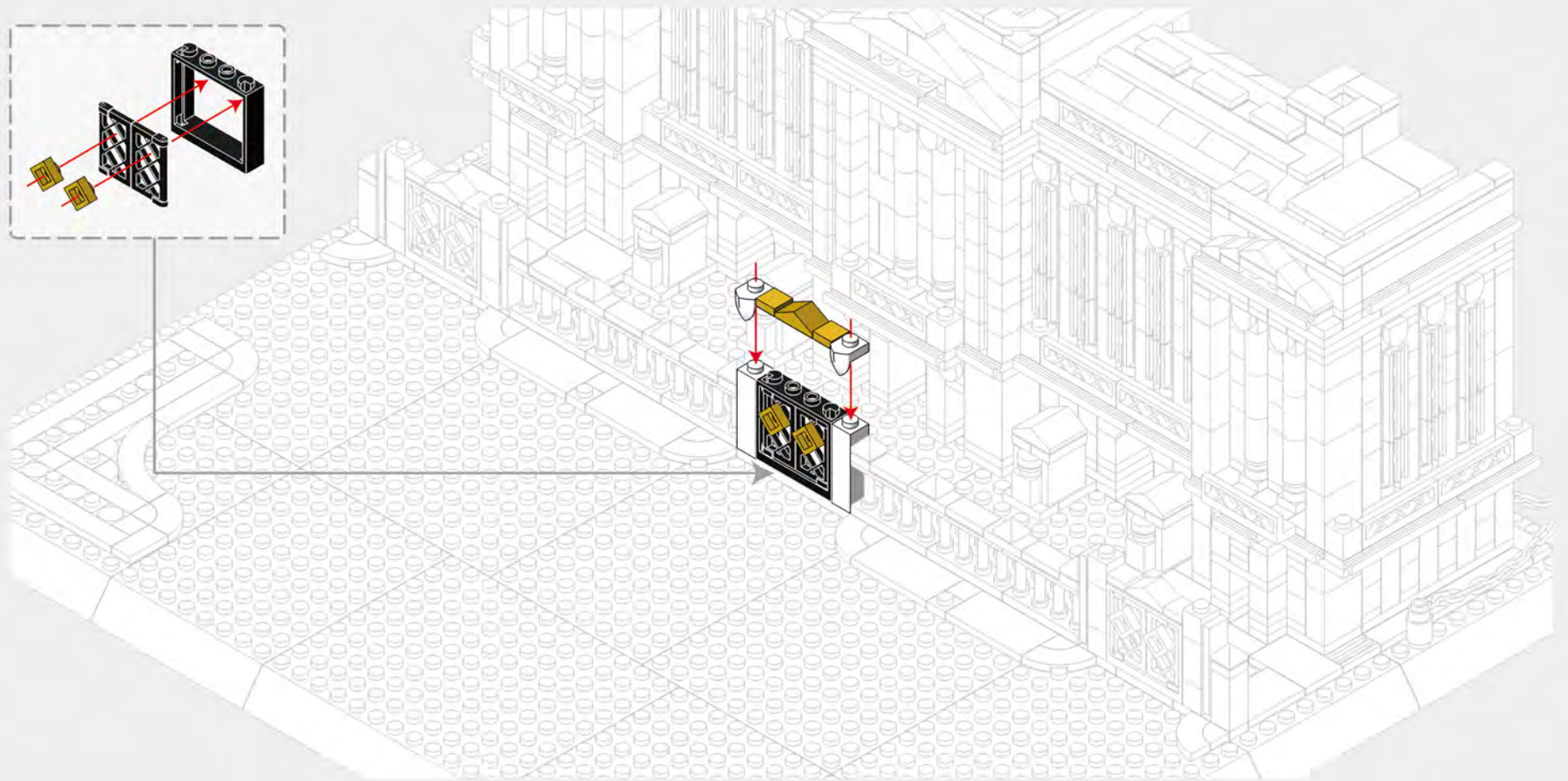
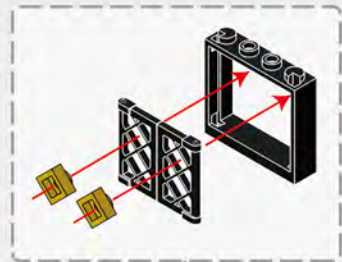
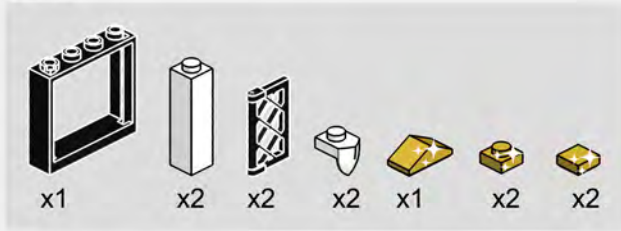



264PCS



91

6-1



6-2

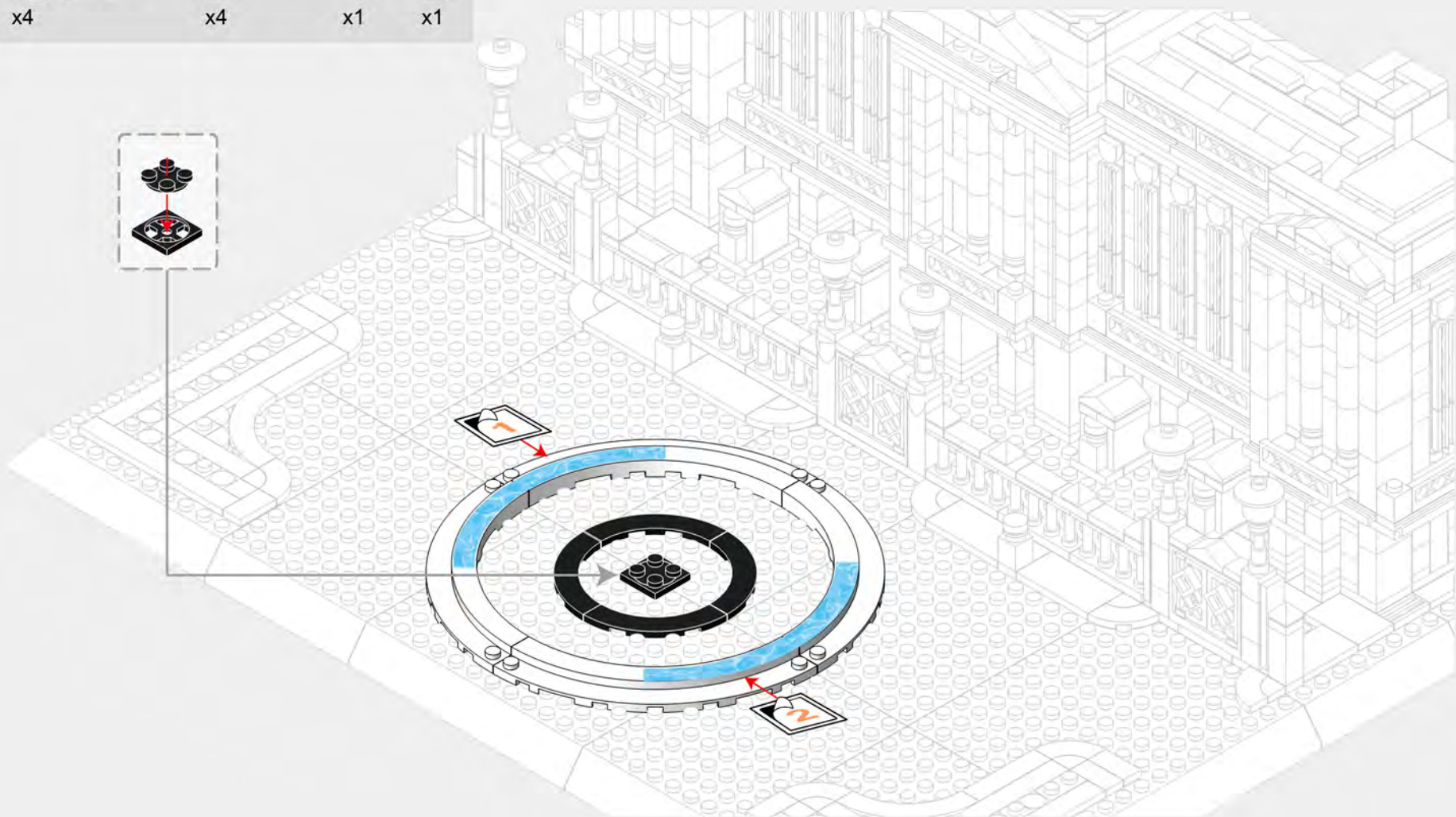
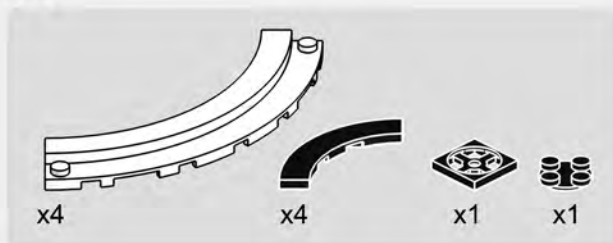

6-3

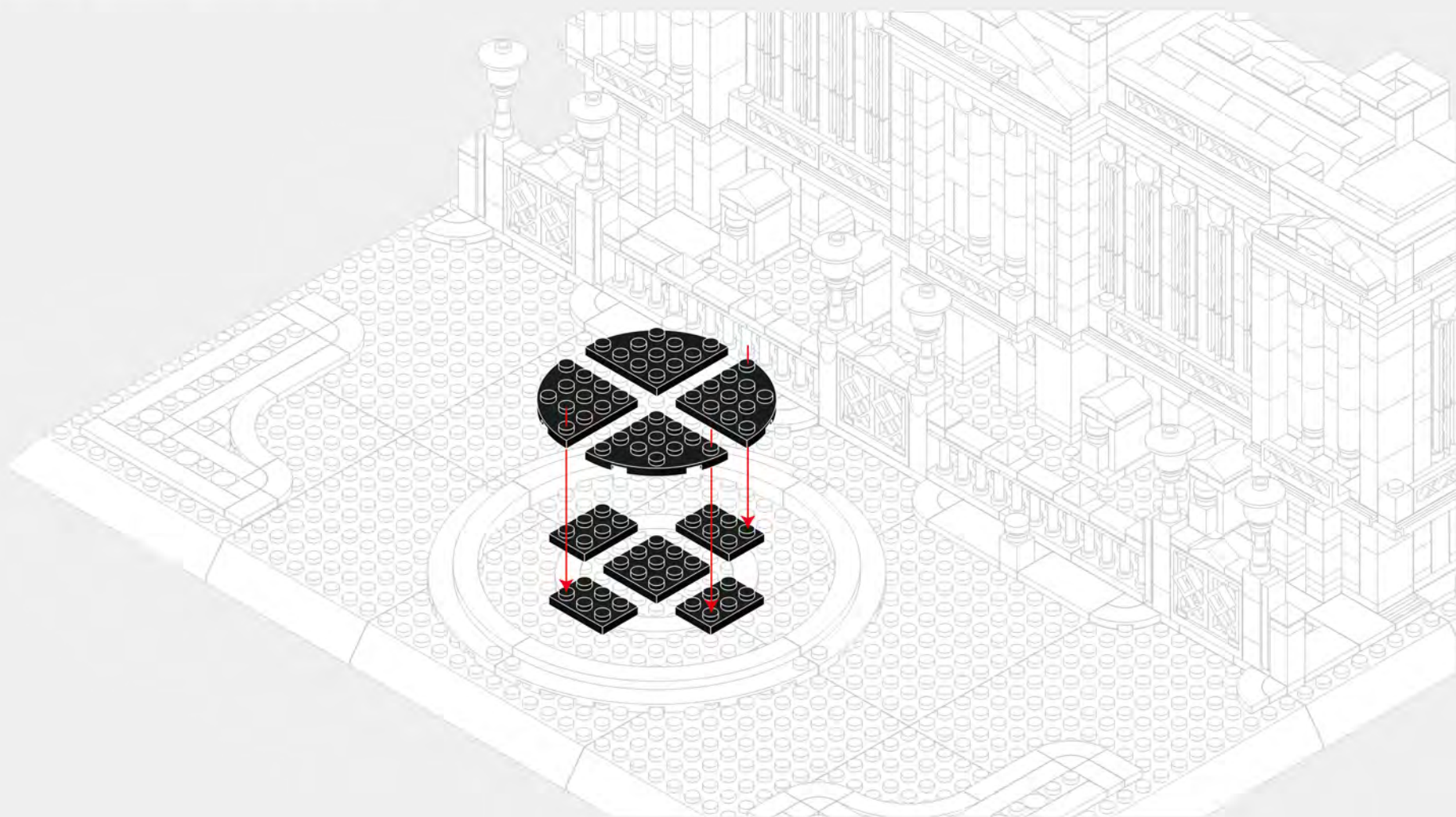

6-4

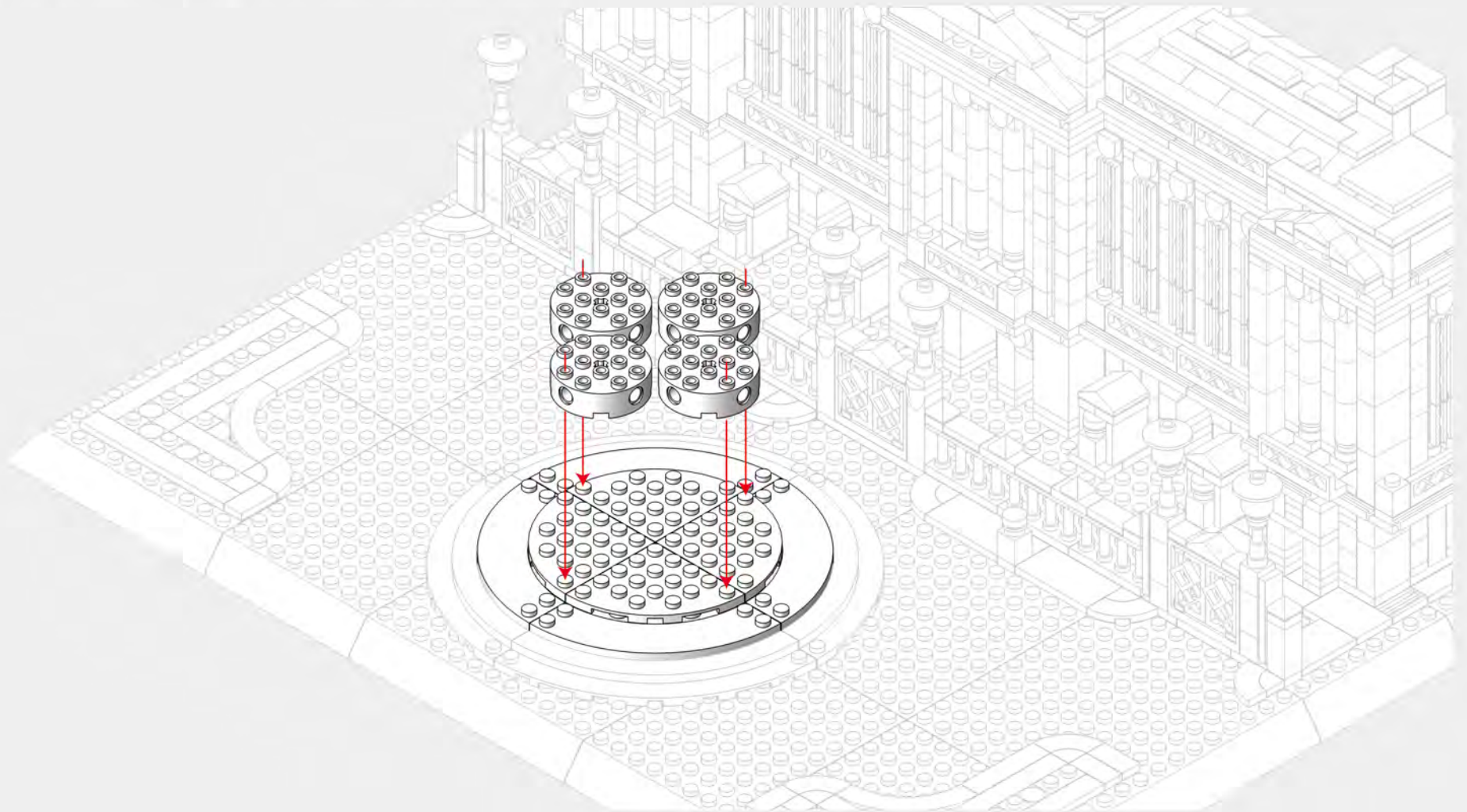
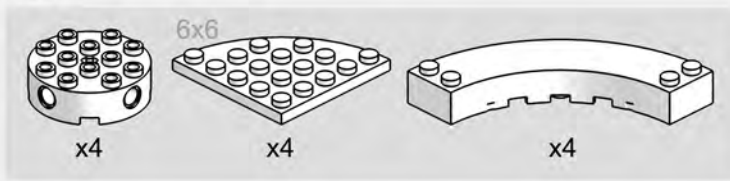

6-5

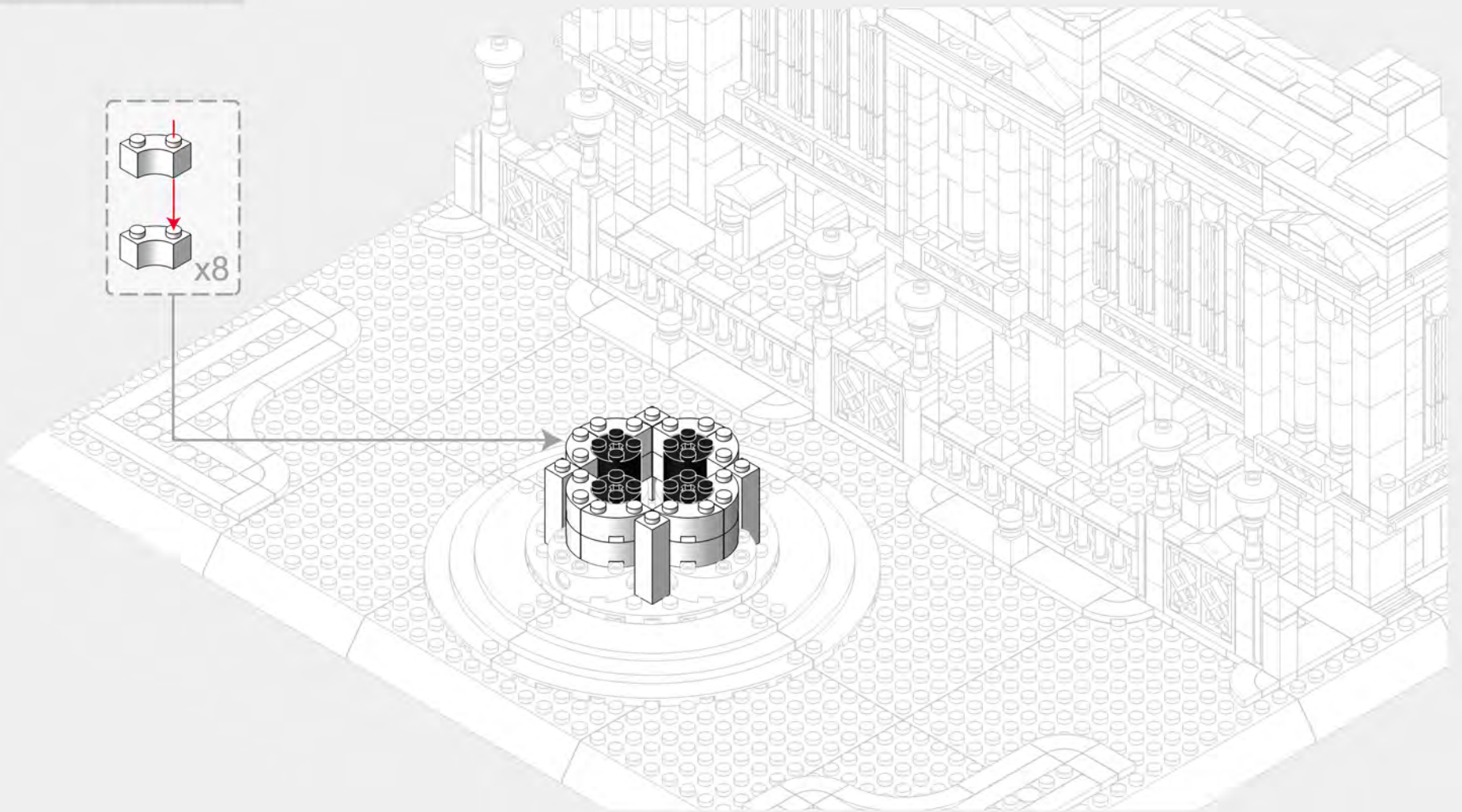
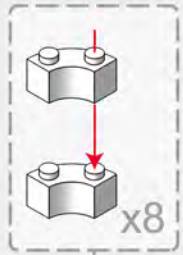
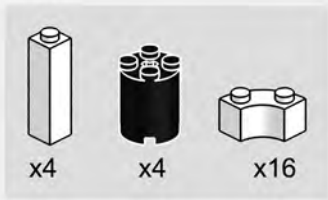

6-6

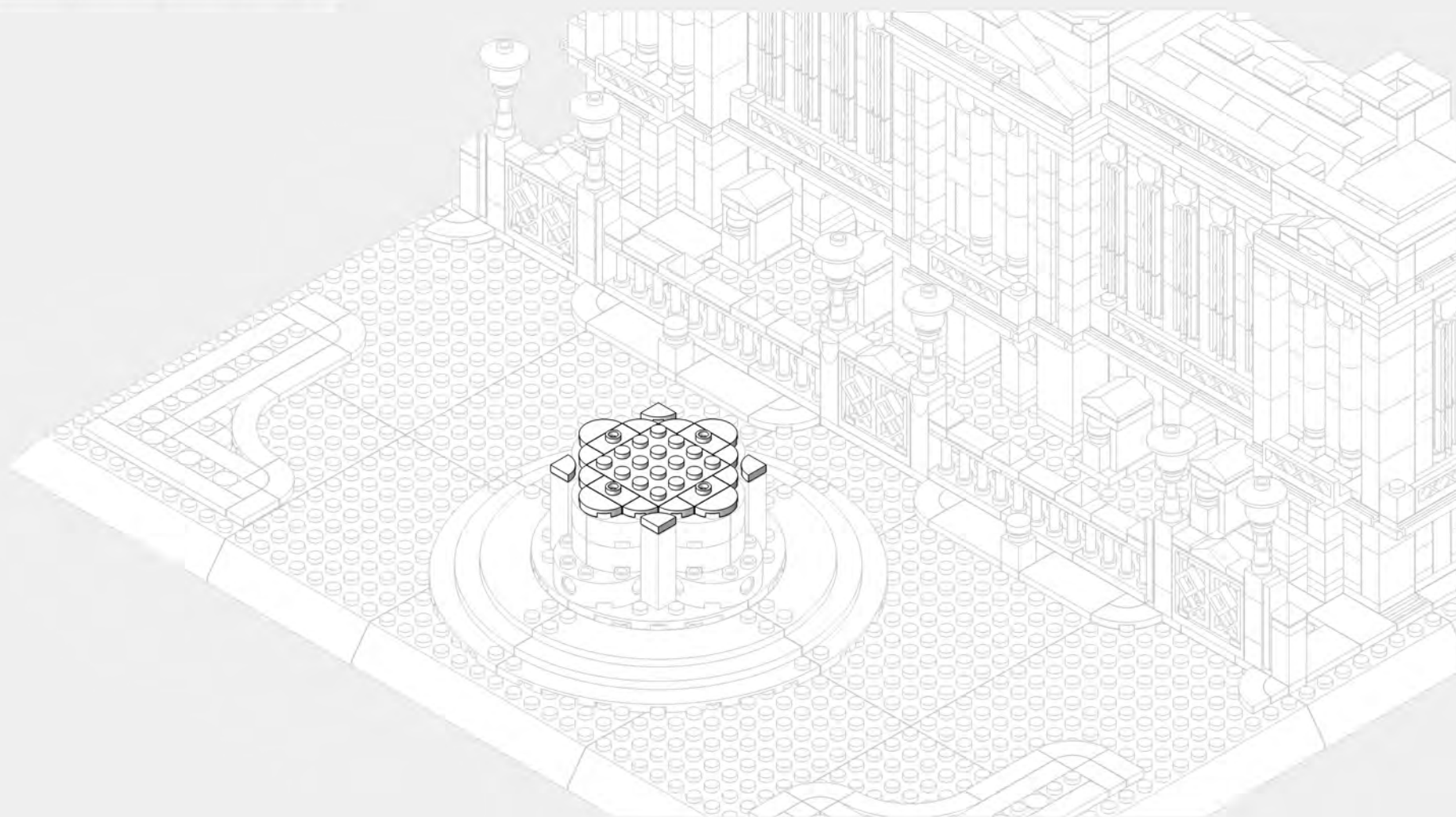
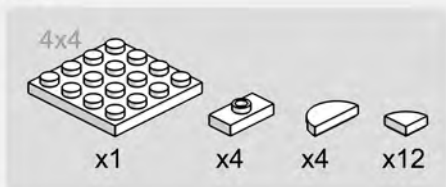

6-7

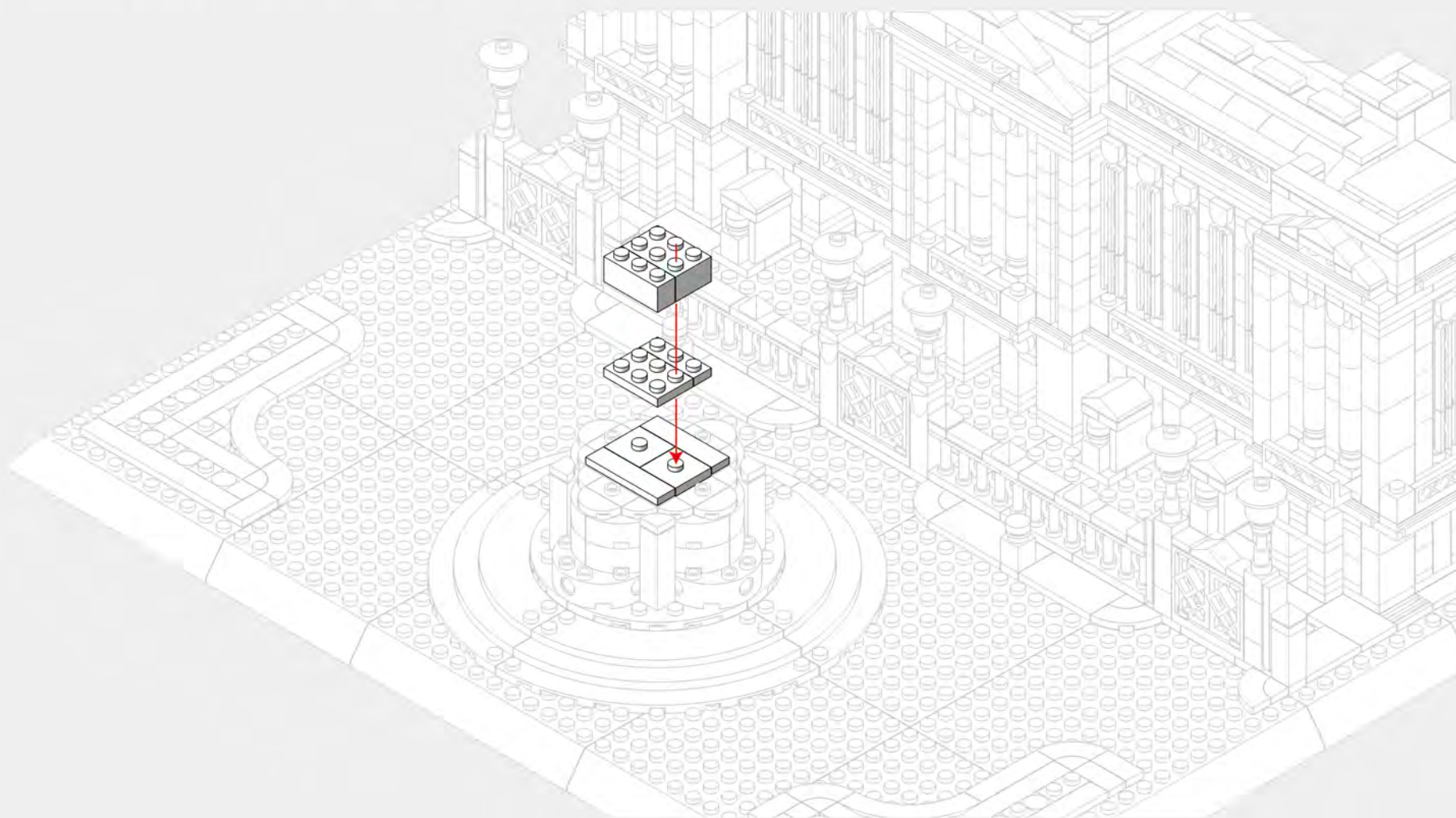
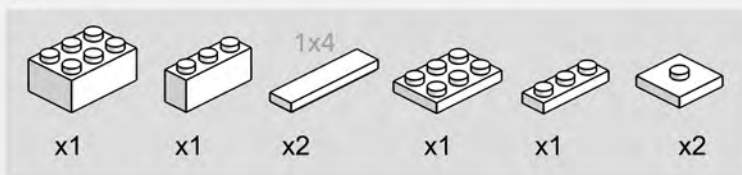

6-8

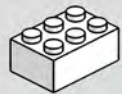

x2



x2



x4



x4



x3

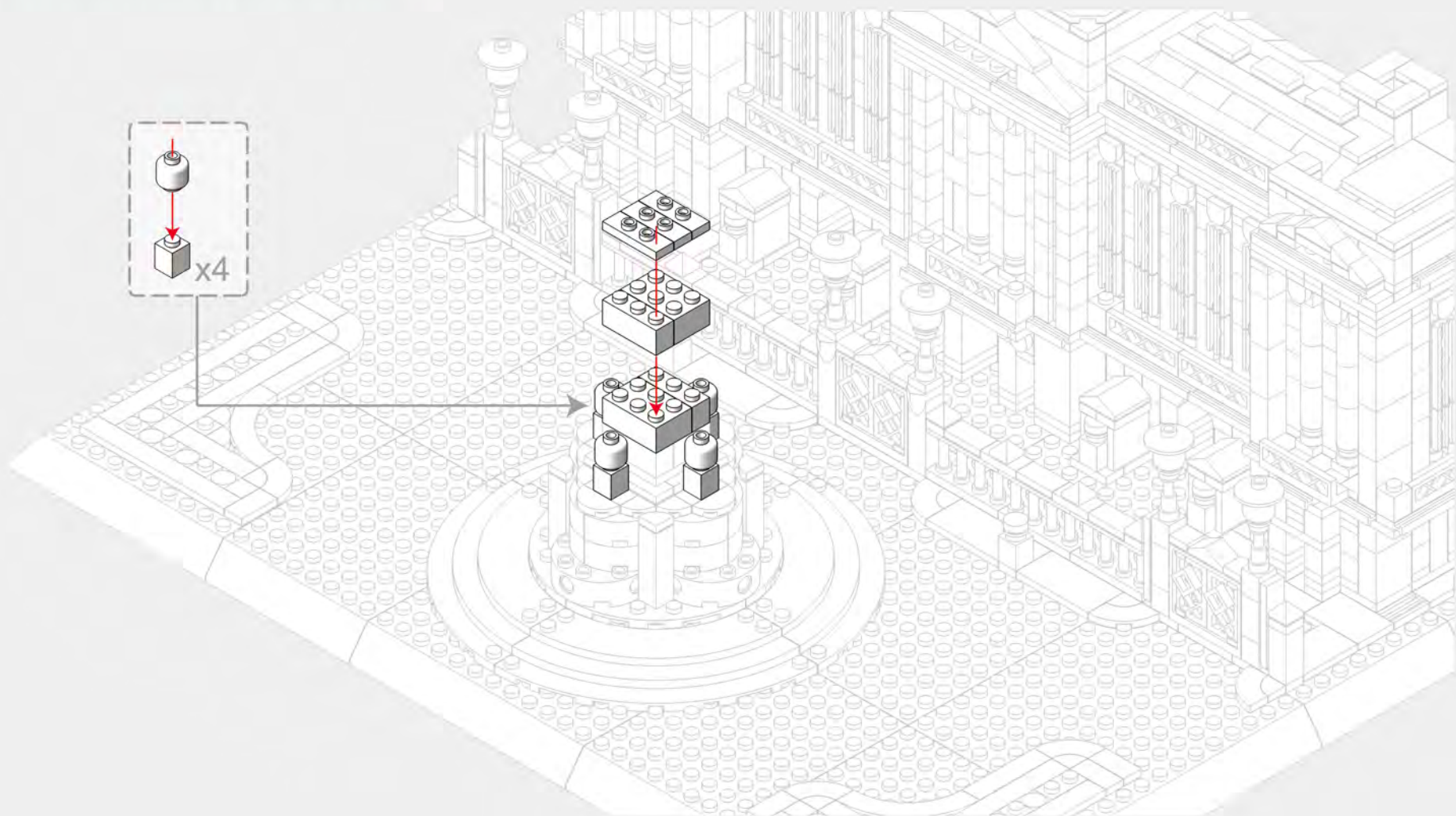
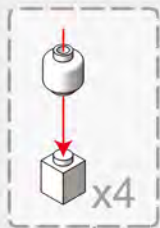

6-9

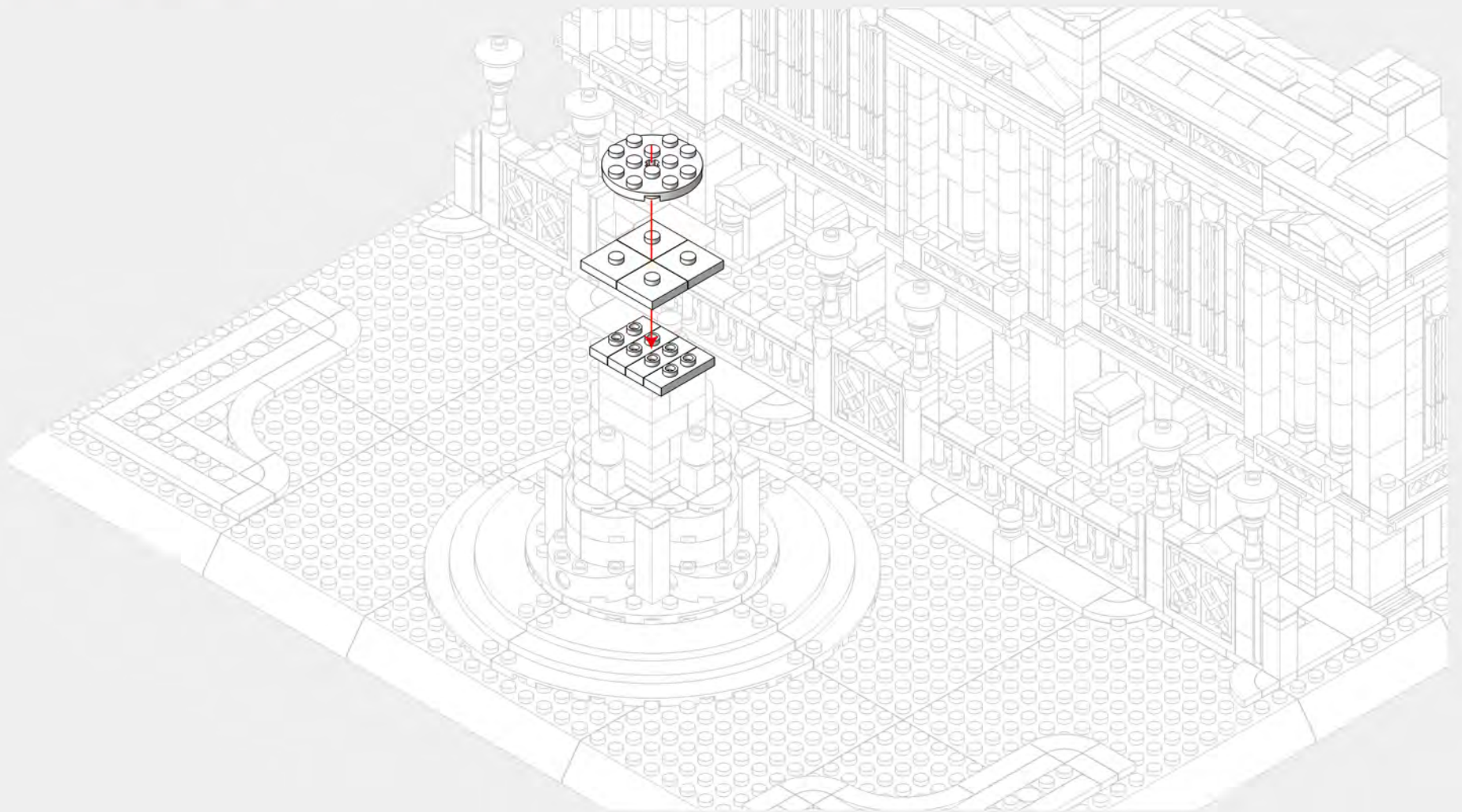
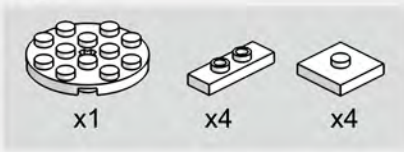

6-10



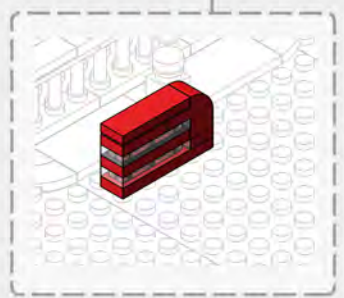
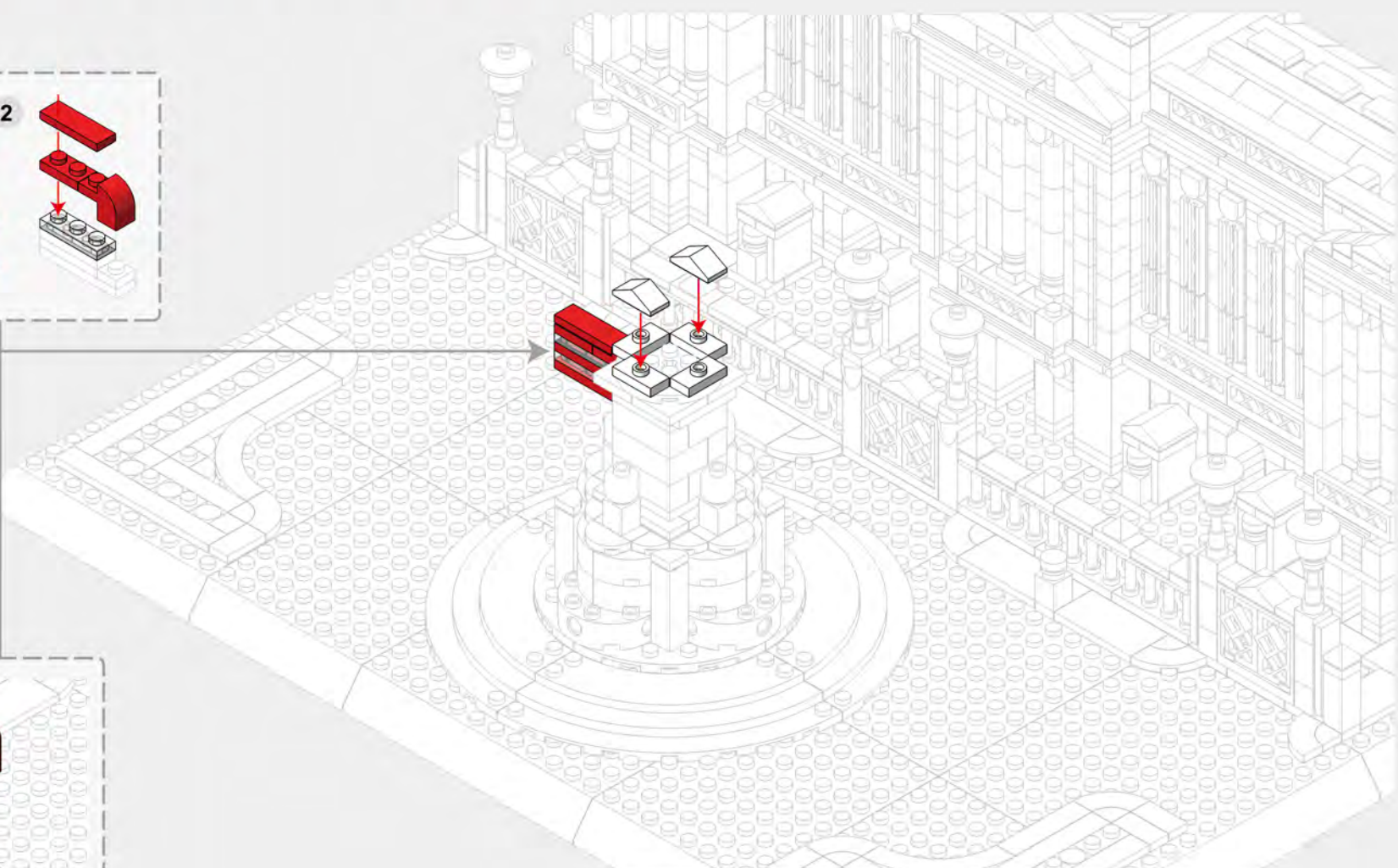
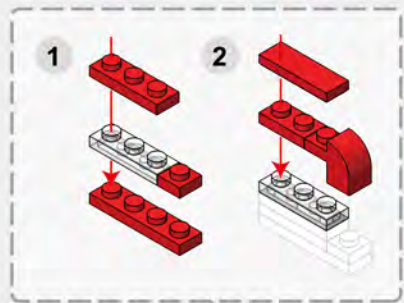



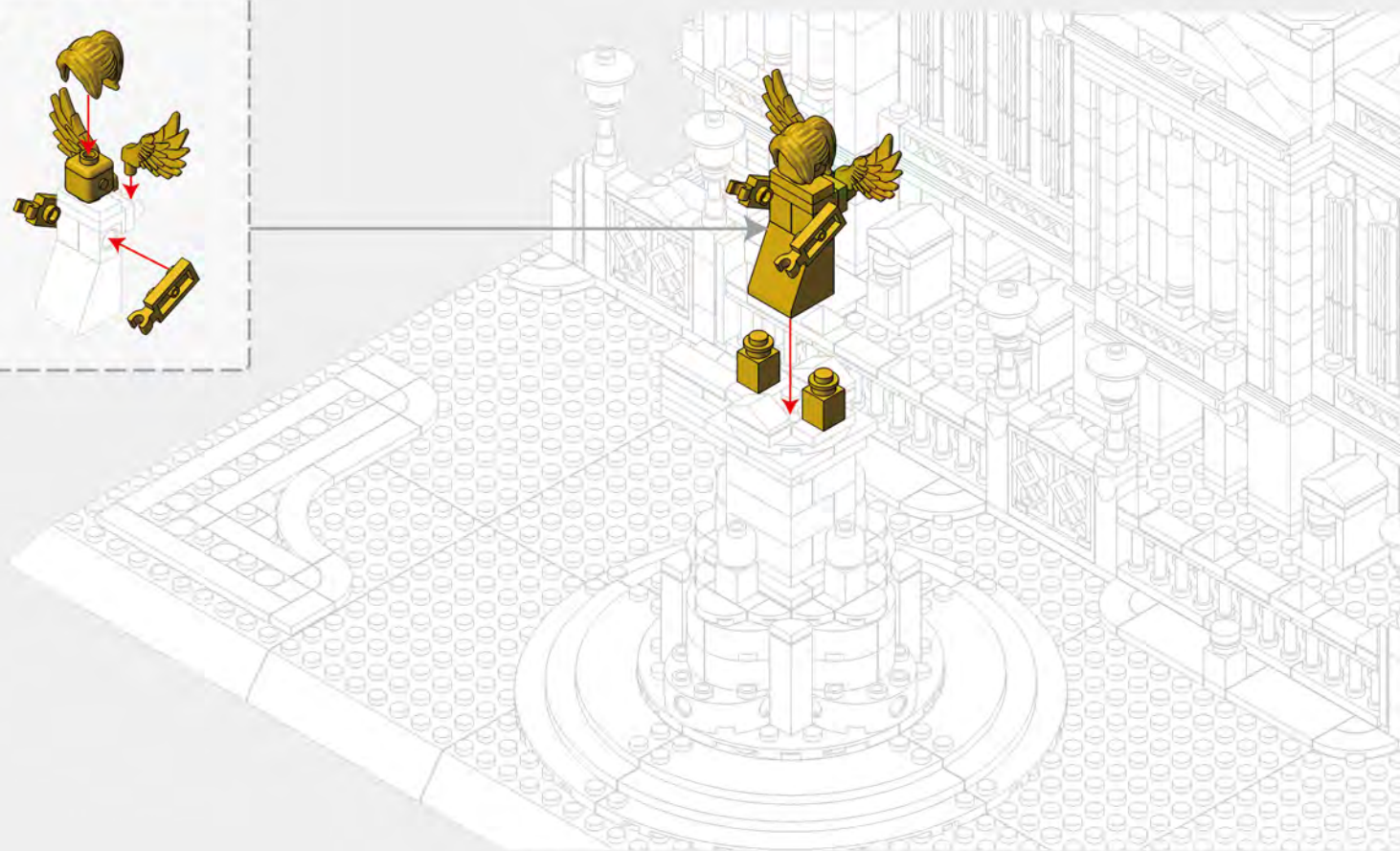
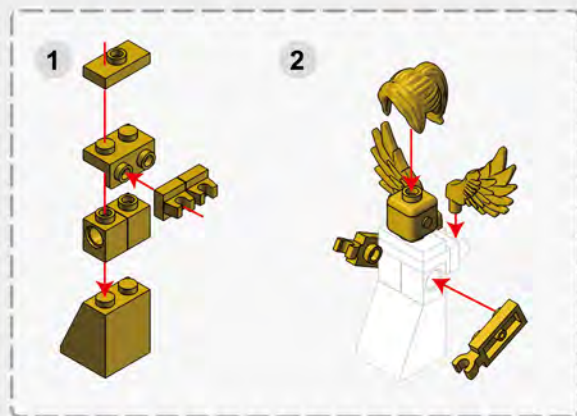

- x1
- x1
- x1
- x2
- x1
- x2
- x4
- x1
- x1



6-11



6-12

-  x4
-  x1
-  x1
-  x1
-  x1
-  x1
-  x1
-  x10
-  x10

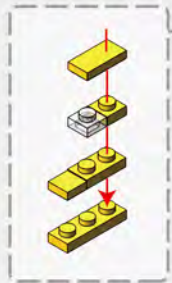

6-13

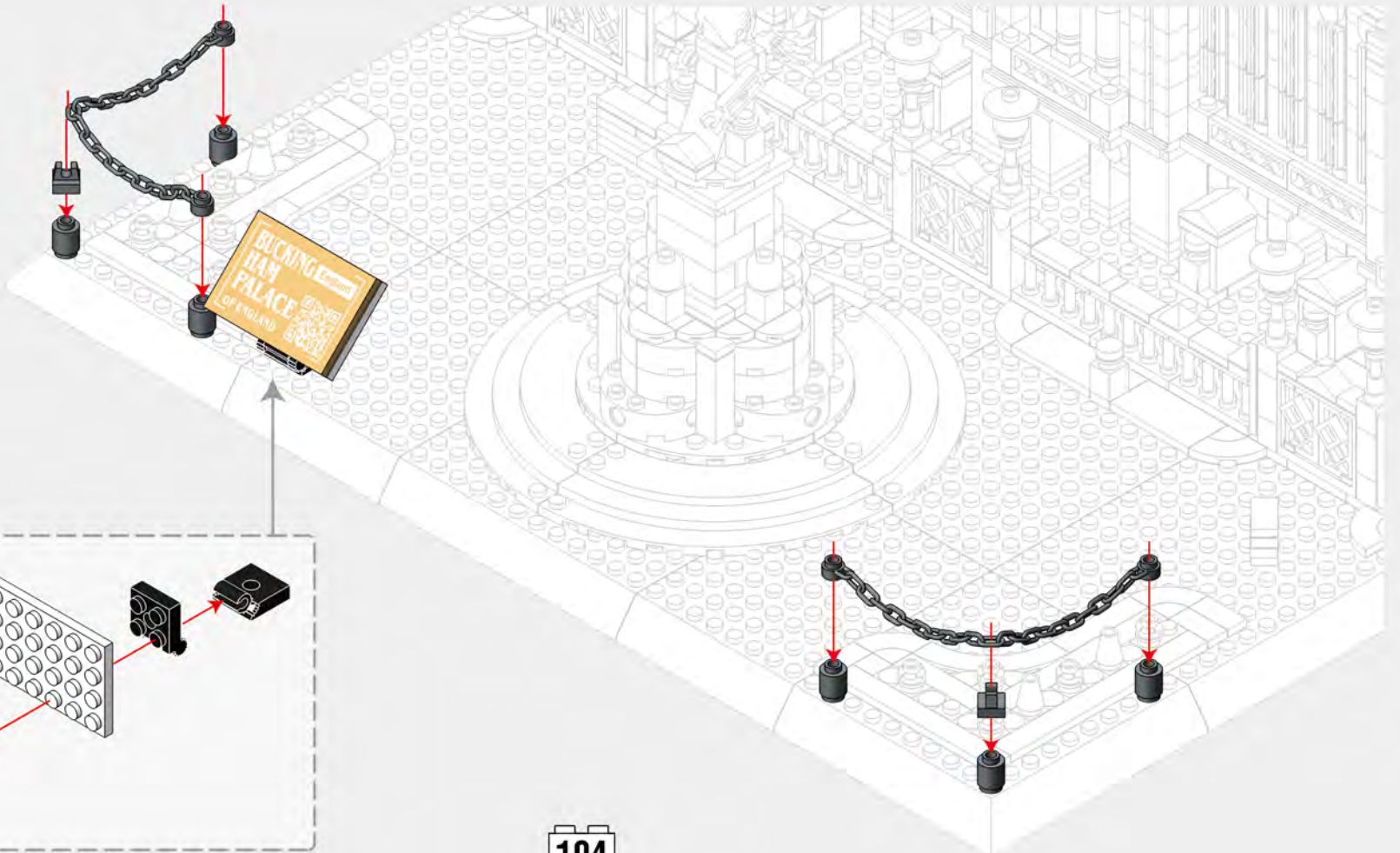
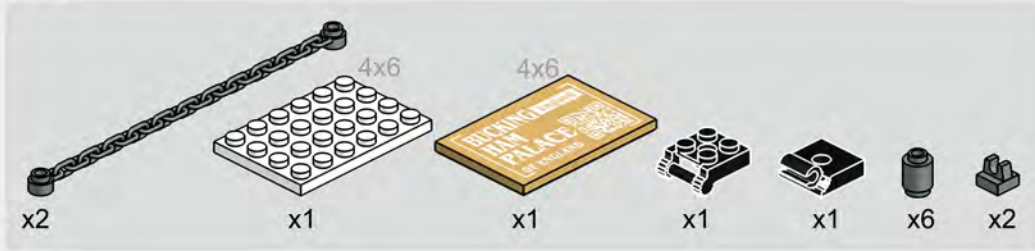

6-14



x8



x4



x16



x16



x4





ARCHITECTURE

The World's great architecture

- Shaping Skills
- Imagination & Curiosity
- Mathematical
- Self Discovery & Perception
- Parent-Child Interaction
- Problem Solving
- Creativity



6223 英国伦敦白金汉宫
BUCKINGHAM PALACE-LONDON,ENGLAND



5225 意大利罗马斗兽场
COLOSSEUM-ROME,ITALY



5226 日本东京帝国饭店
IMPERIAL HOTEL-TOKYO,JAPAN



5227 美国纽约自由女神像
STATUE OF LIBERTY-NEW YORK,AMERICA



6211 德国柏林勃兰登堡门
BRANDENBURG GATE-BERLIN, GERMANY



6222 中国甘肃长城-嘉峪关
JIAYU PASS-GANSU,CHINA



6212 日本京都清水寺仁王门
NIOMON GATE OF KIYOMIZU-DERA-KYOTO,JAPAN



6213 俄罗斯莫斯科瓦西里大教堂
SAINT BASIL'S CATHEDRAL-MOSCOW,RUSSIA



6214 中国武汉黄鹤楼
YELLOW CRANE TOWER-WUHAN,CHINA



6215 英国伦敦眼
LONDON EYE-LONDON,ENGLAND



6221 中国北京故宫-太和殿
HALL OF SUPREME HARMONY-BEIJING,CHINA



6220 沙特阿拉伯麦加大清真寺
GREAT MOSQUE OF MECCA,SAUDI ARABIA



6219 美国纽约联合国大厦
UNITED NATIONS HEADQUARTERS-NEW YORK,AMERICA



4214 美国华盛顿白宫
WHITE HOUSE-WASHINGTON D.C.,AMERICA



4212 意大利罗马许愿池
TREVİ FOUNTAIN-ROME,ITALY



4213 法国巴黎卢浮宫
MUSÉE DU LOUVRE-PARIS,FRANCE



4218 新加坡-鱼尾狮
MERLION,SINGAPORE



4219 英国伦敦双子塔桥
TOWER BRIDGE-LONDON,ENGLAND



4216 美国华盛顿林肯纪念堂
LINCOLN MEMORIAL-WASHINGTON D.C.,AMERICA



4217 新加坡-金沙酒店
MARINA BAY SANDS,SINGAPORE



4210 埃及开罗吉萨金字塔
GREAT PYRAMID OF GIZA-CAIRO,EGYPT



4221 加拿大渥太华国会山庄
PARLIAMENT BUILDINGS-OTTAWA,CANADA



4211 英国伦敦伊丽莎白塔
ELIZABETH TOWER-ENGLAND



4215 加拿大多伦多电视塔
THE CN TOWER-CANADA



4220 美国纽约熨斗大厦
FLATIRON BUILDING-NEW YORK,AMERICA



4222 阿联酋迪拜哈利法塔
THE BURJ KHALIFA TOWER-DUBAI,UAE



5224 中国上海东方明珠广播电视塔
ORIENTAL PEARL TOWER-SHANGHAI,CHINA



5212 美国纽约帝国大厦
EMPIRE STATE BUILDING-NEW YORK,AMERICA



5213 马来西亚吉隆坡石油双塔
PETRONAS TWIN TOWERS-KUALA LUMPUR,MALAYSIA



5214 意大利托斯卡纳比萨斜塔
LEANING TOWER OF PISA-TUSCANY,ITALY



5216 英国伦敦伊丽莎白塔
ELIZABETH TOWER-LONDON,ENGLAND

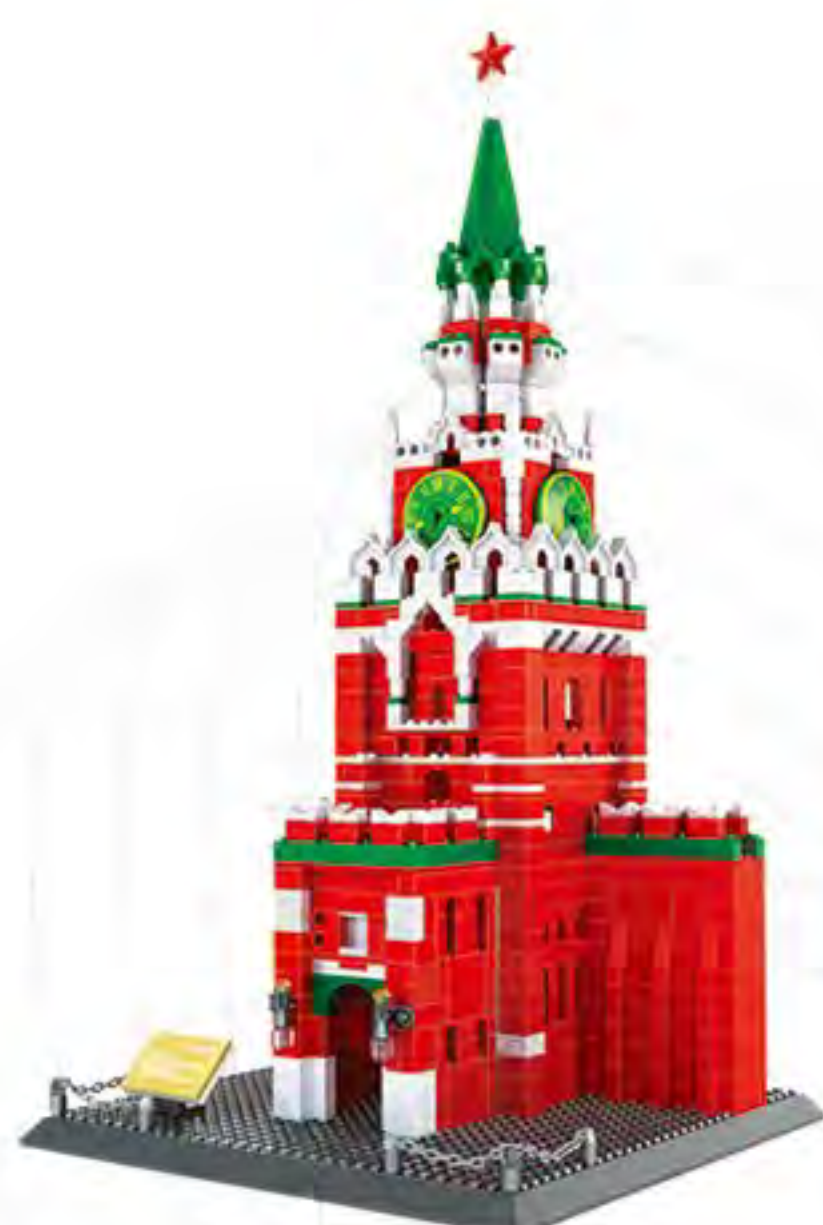

5219 俄罗斯莫斯科克里姆林宫钟楼
SPASSKAYA TOWER-MOSCOW,RUSSIA



5220 阿联酋迪拜卓美亚帆船酒店
BURJ AL ARAB HOTEL-DUBAI,UAE



5217 法国巴黎埃菲尔铁塔
EIFFEL TOWER-PARIS,FRANCE



5221 中国台北101大楼
TAIPEI 101-TAIPEI,CHINA



6223 中国武汉长江大桥
WUHAN YANGTZE RIVER BRIDGE



5210 法国巴黎圣母院大教堂
CATHÉDRALE NOTRE DAME DE PARIS-PARIS,FRANCE



5211 印度阿格拉泰姬陵
TAJ MAHAL-AGRA,INDIA



5223 法国巴黎凯旋门
ARC DE TRIOMPHE-PARIS,FRANCE



5215 英国伦敦双子塔桥
TOWER BRIDGE-LONDON,ENGLAND



5222 中国北京天坛祈年殿
HALL OF PRAYER FOR GOOD HARVESTS-BEIJING,CHINA



6210 美国旧金山金门大桥
GOLDEN GATE BRIDGE-SAN FRANCISCO,AMERICA



6216 中国北京万里长城（八达岭）
THE GREAT WALL-BEIJING,CHINA



5218 中国北京天安门
TIANANMEN TOWER-BEIJING,CHINA



6217 中国西藏布达拉宫
POTALA PALACE-TIBET,CHINA



6218 芬兰罗瓦涅米圣诞老人办公室
SANTA CLAUS OFFICE-ROVANIEMI,FINLAND

BUCKINGHAM PALACE

COUNTRY: England

CITY: London



微信扫一扫
补件更简单

