

E56

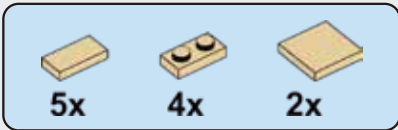

E57

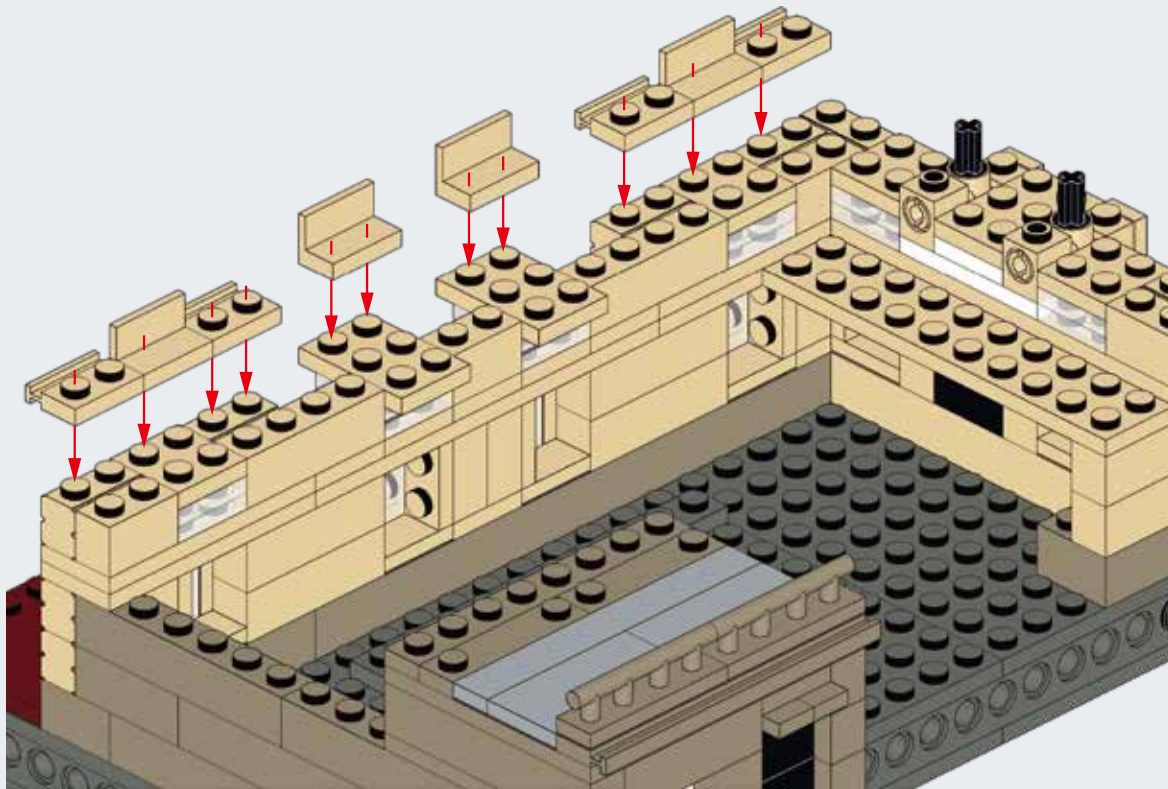

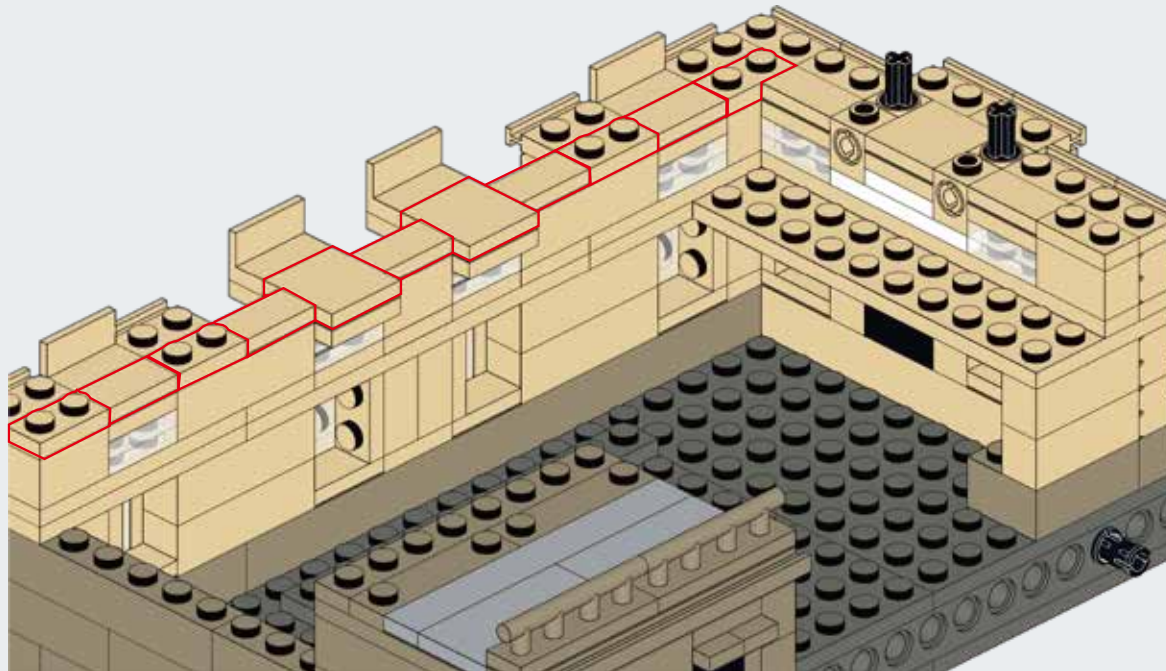

6x

E58

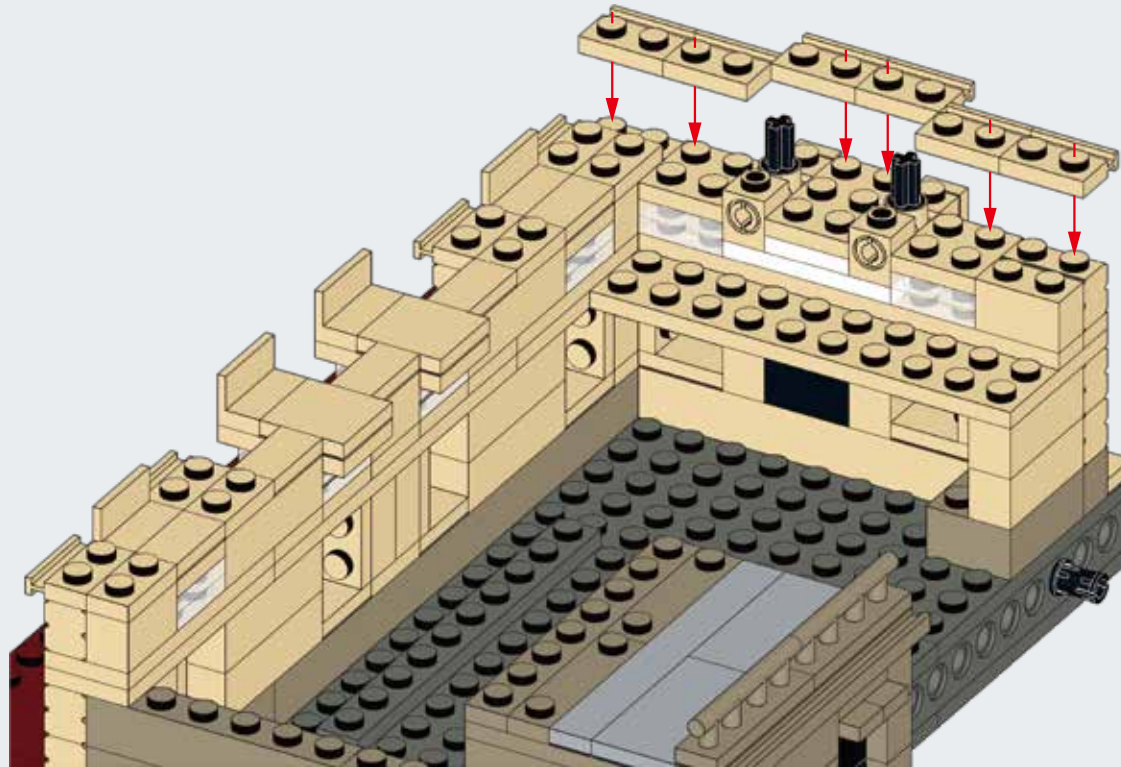

2x

1x

1x

E59

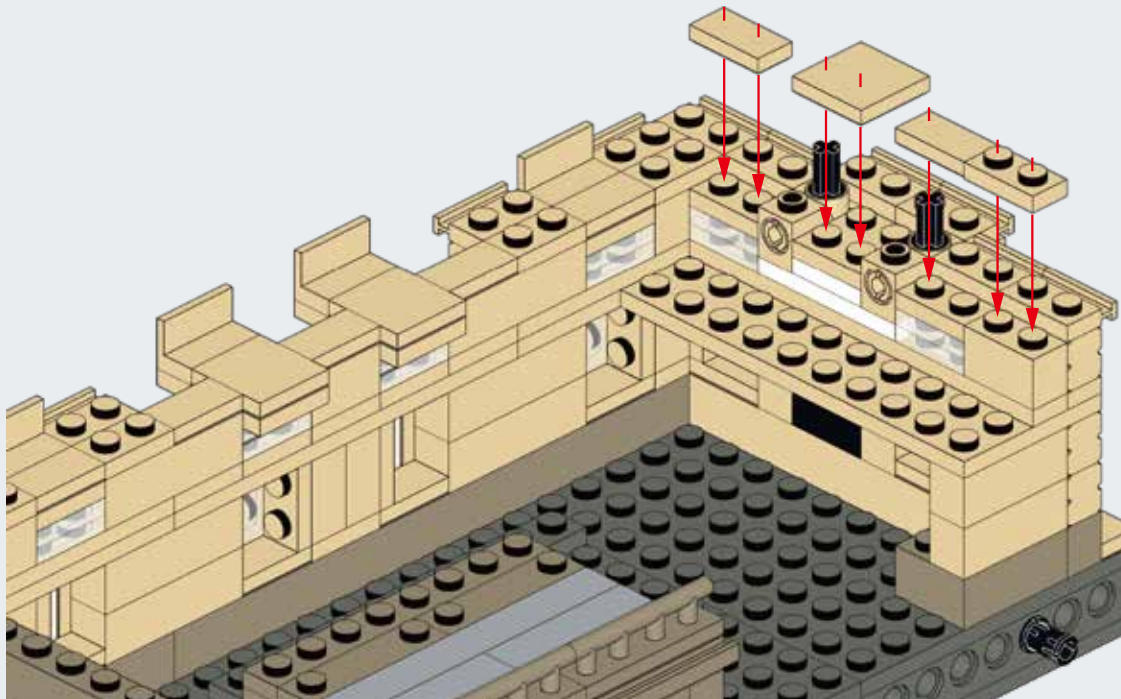

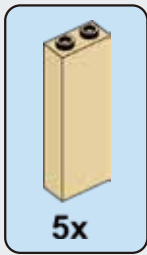

E60

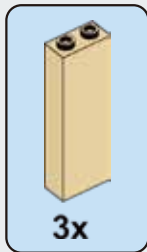
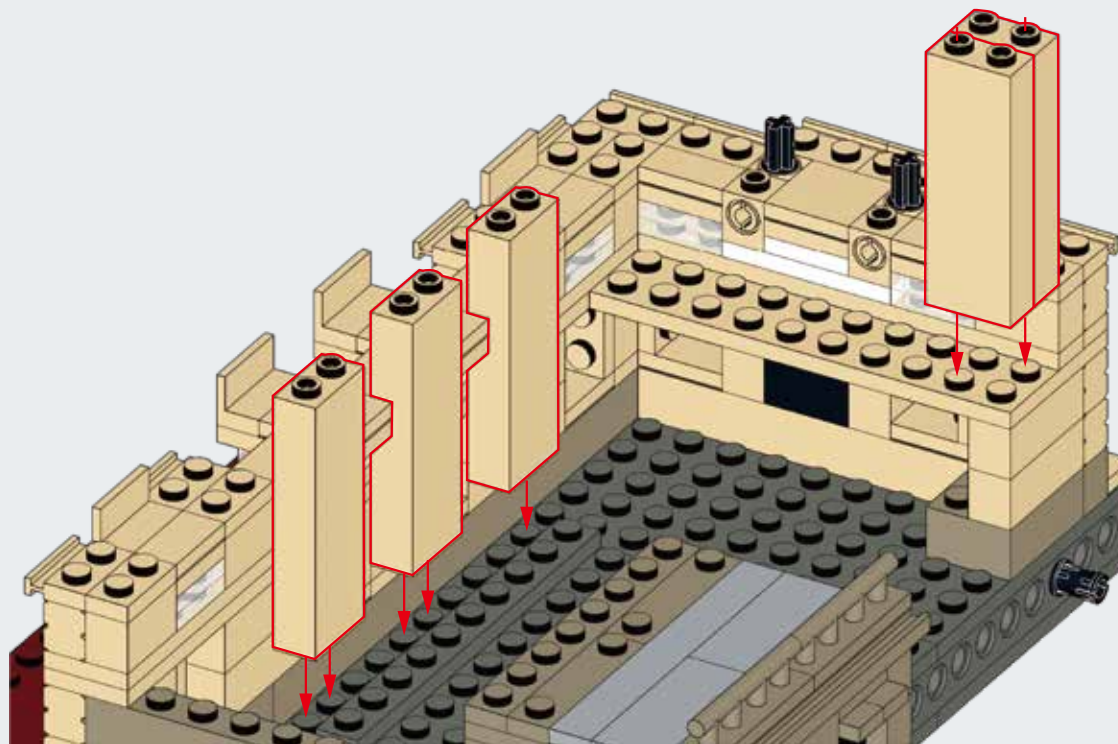

E61

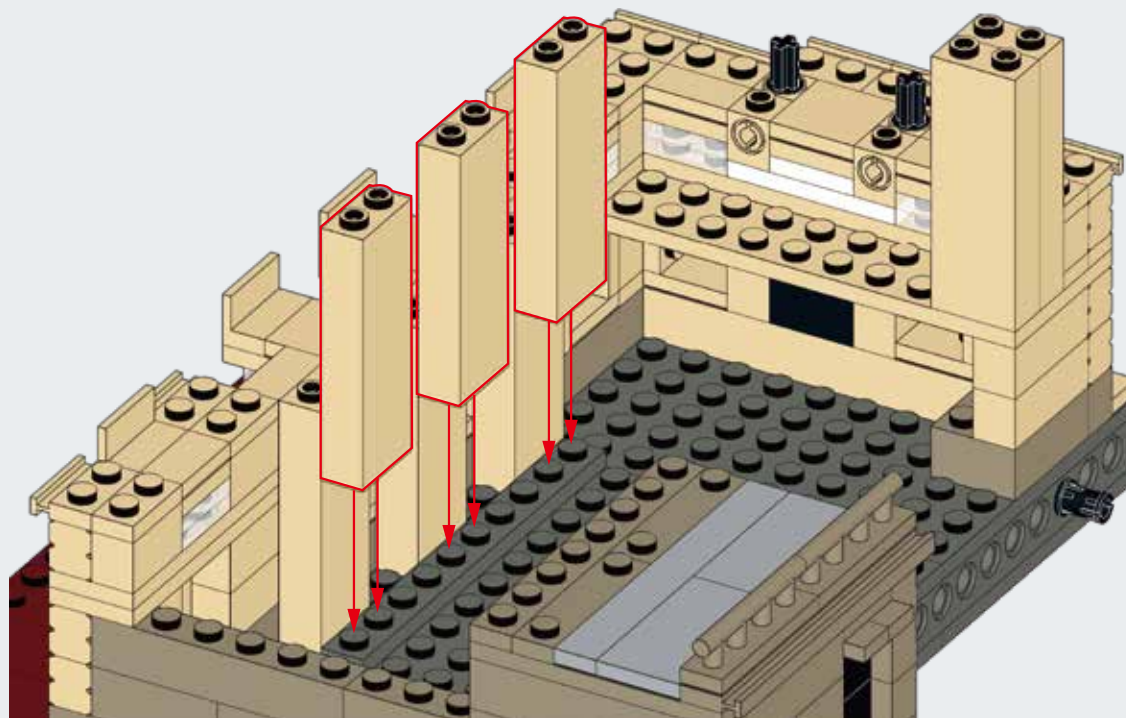



1x

E62

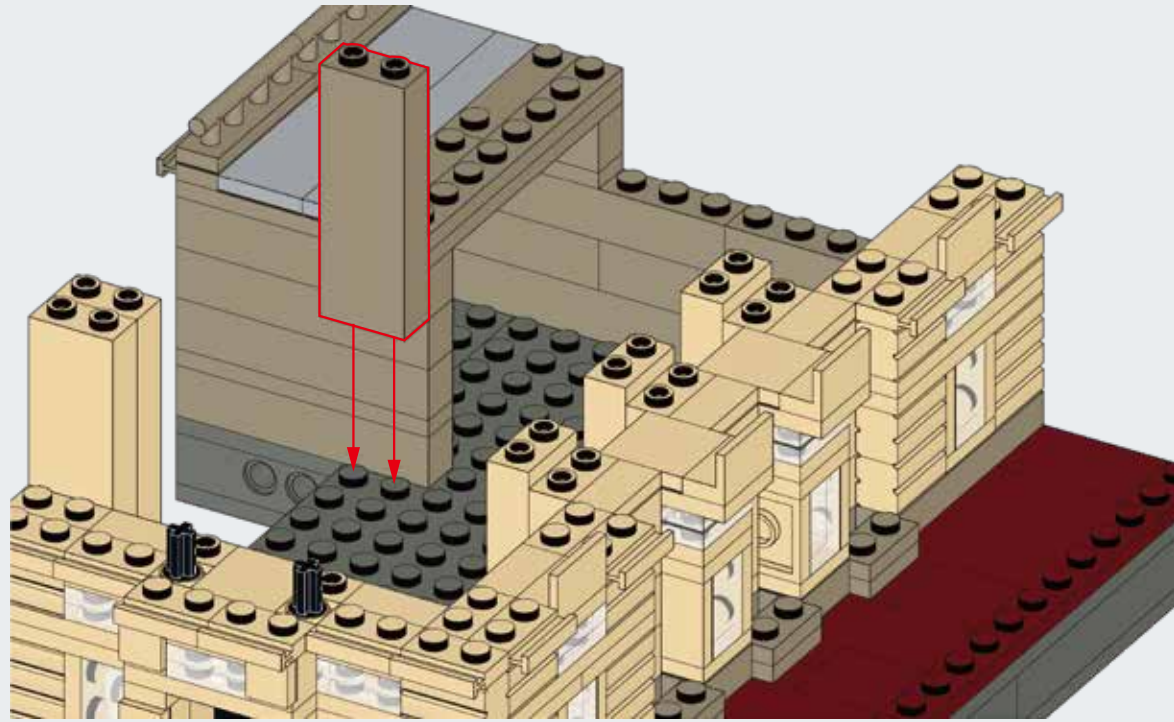
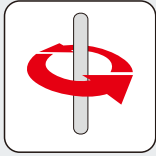

3x

6x

9x

E63

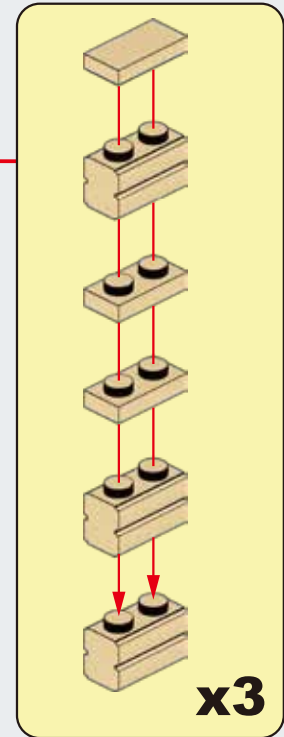
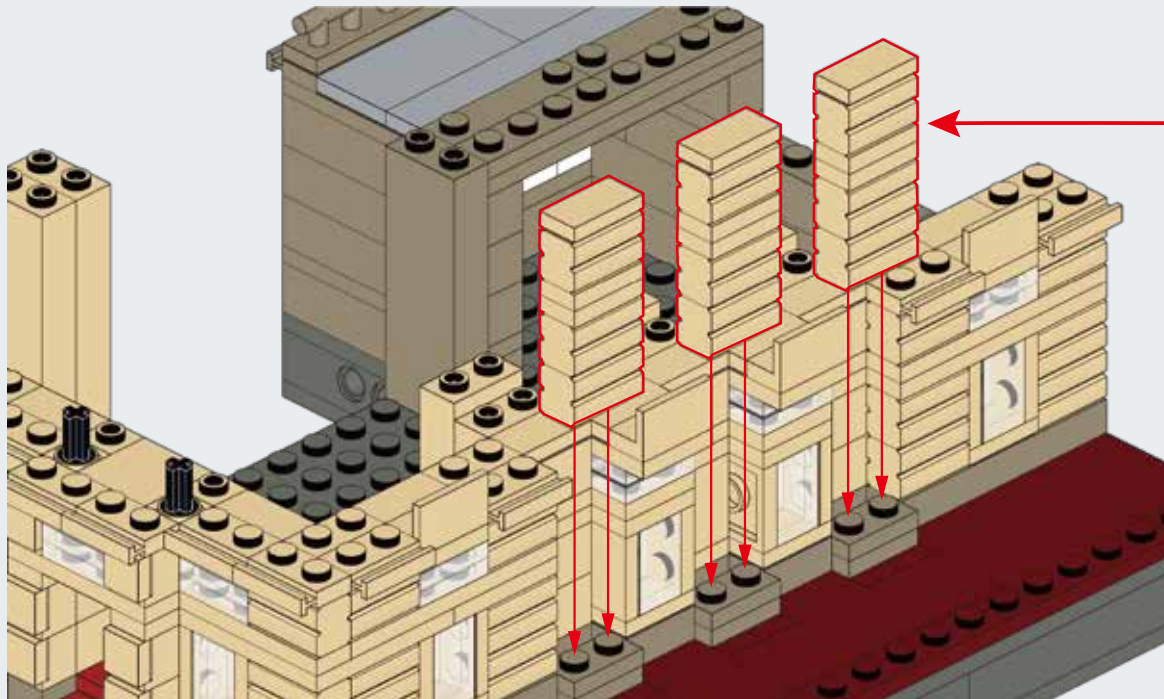

x3

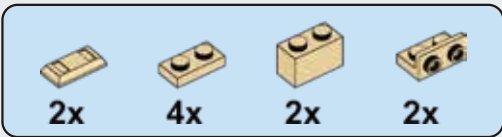

E64

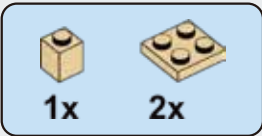
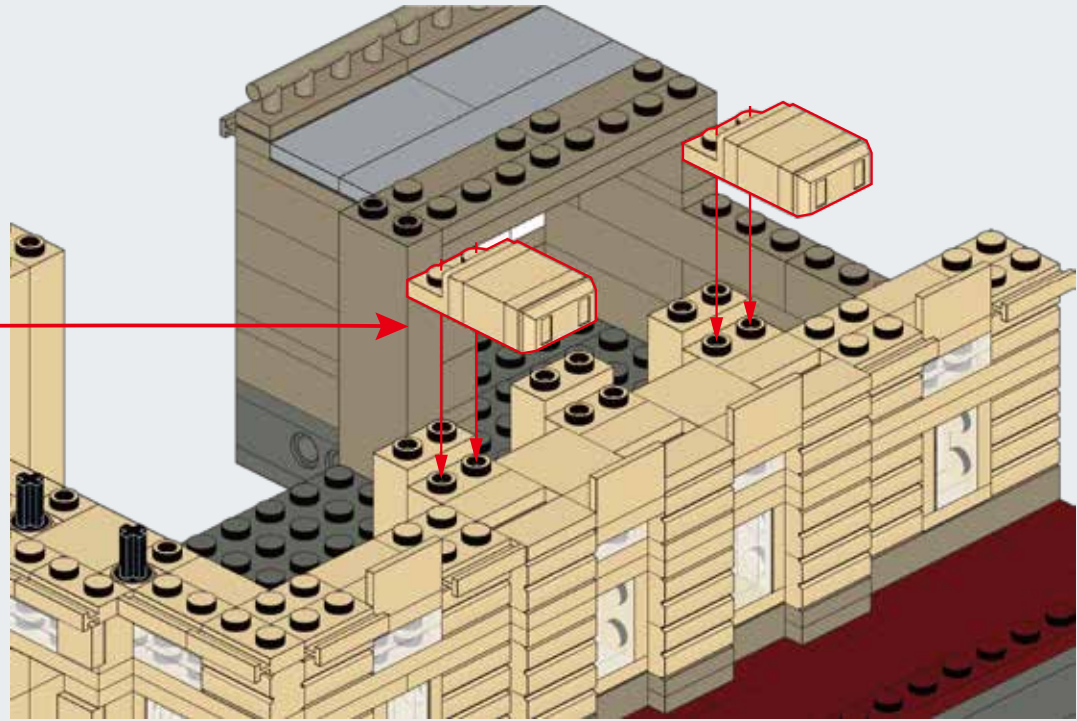
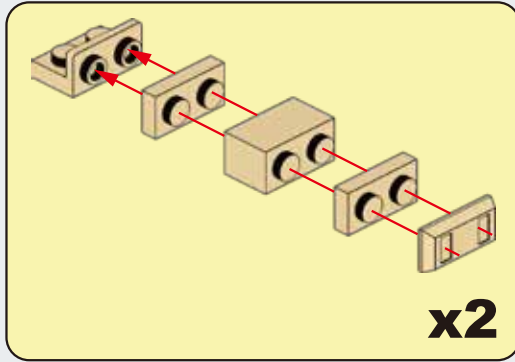

E65

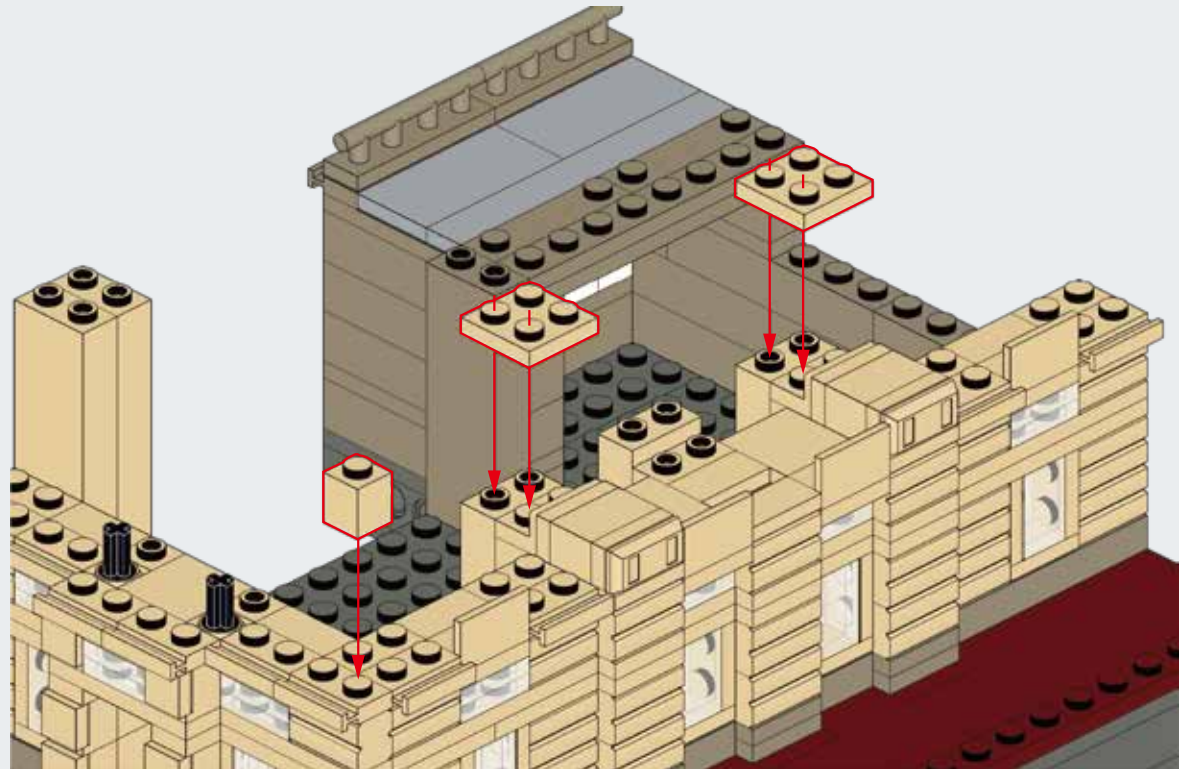



E66

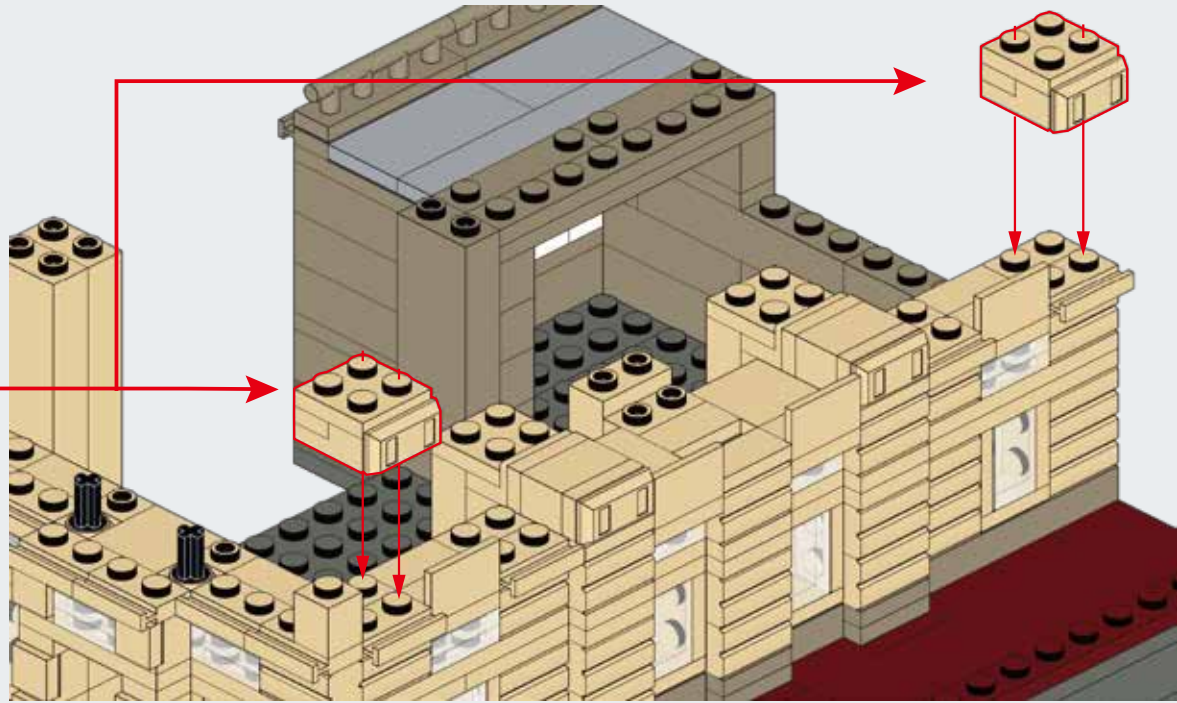
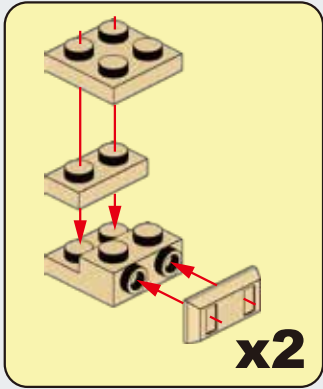

E67

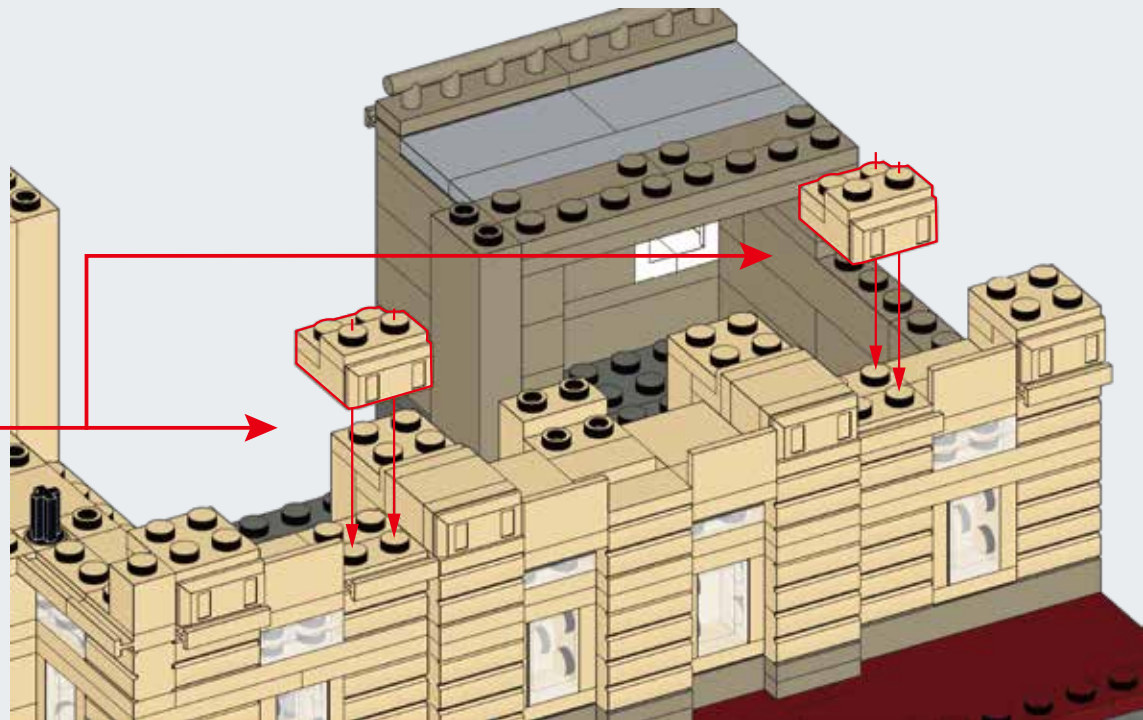
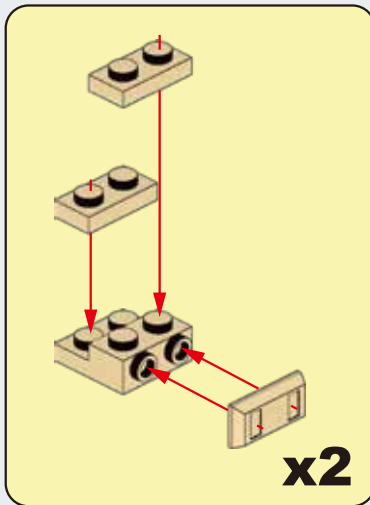

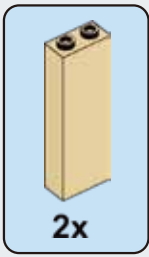

E68

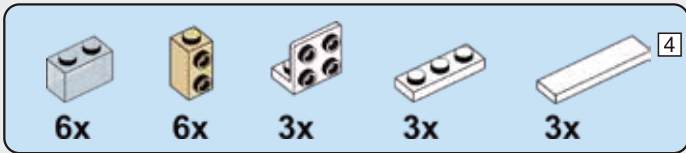
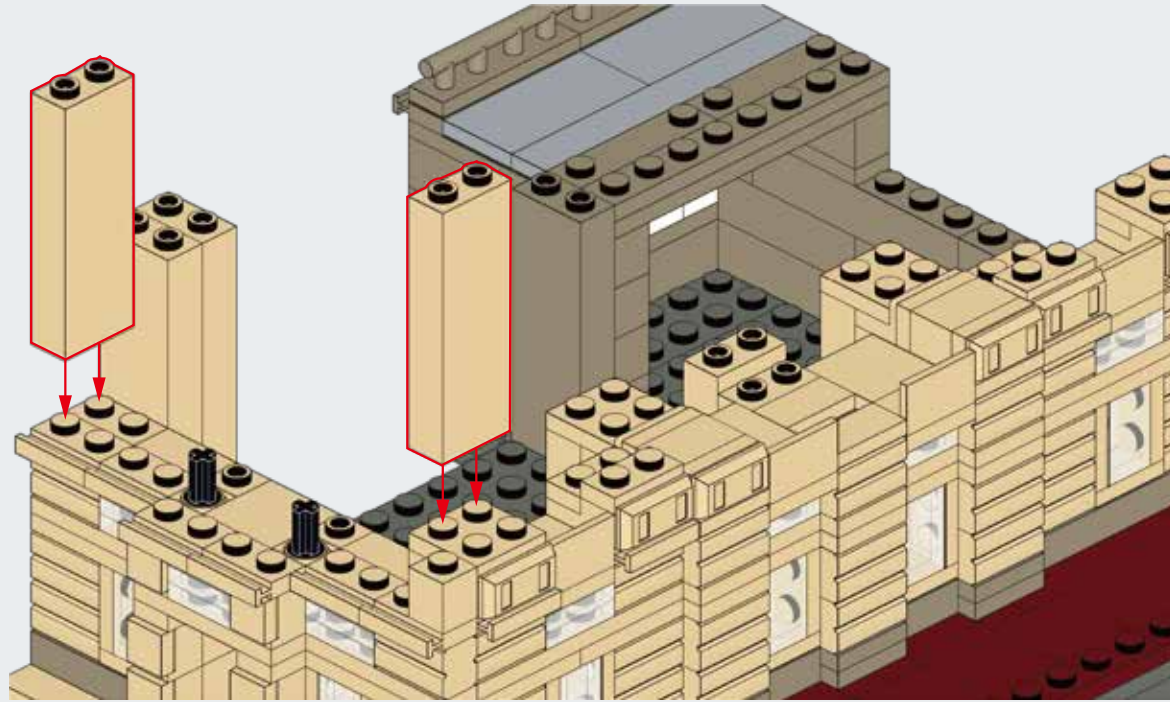

E69

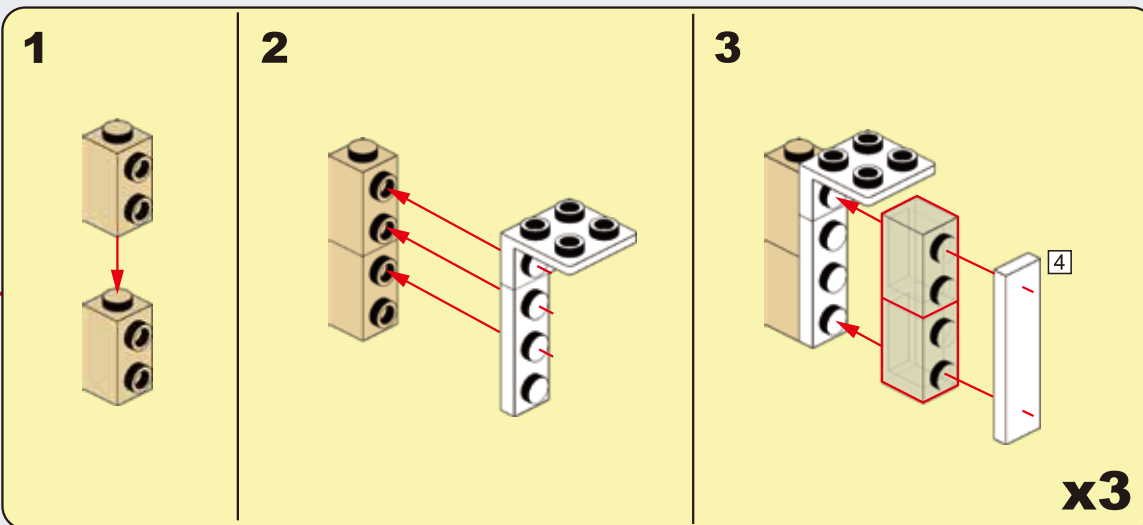
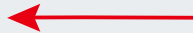
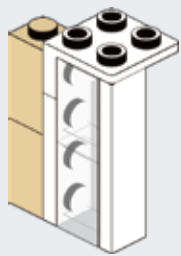

E70

E68

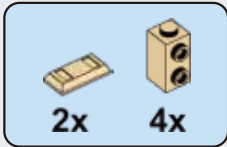
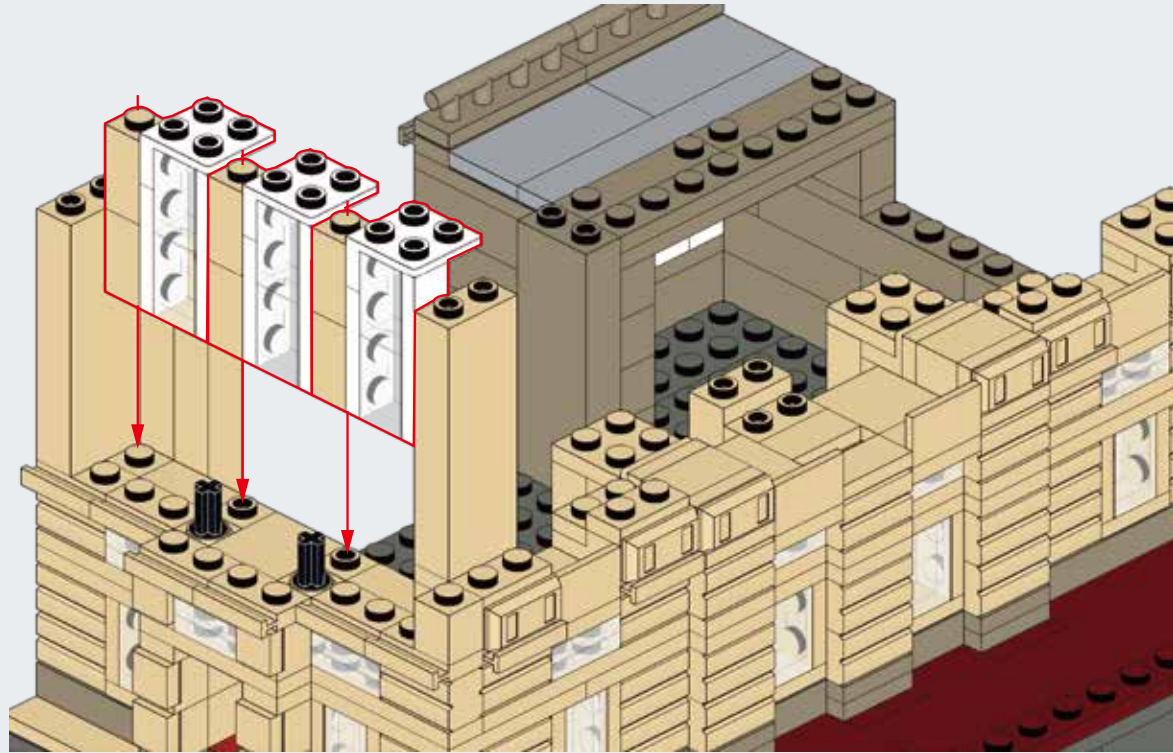

E71

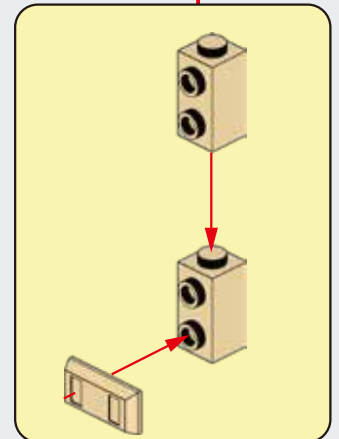
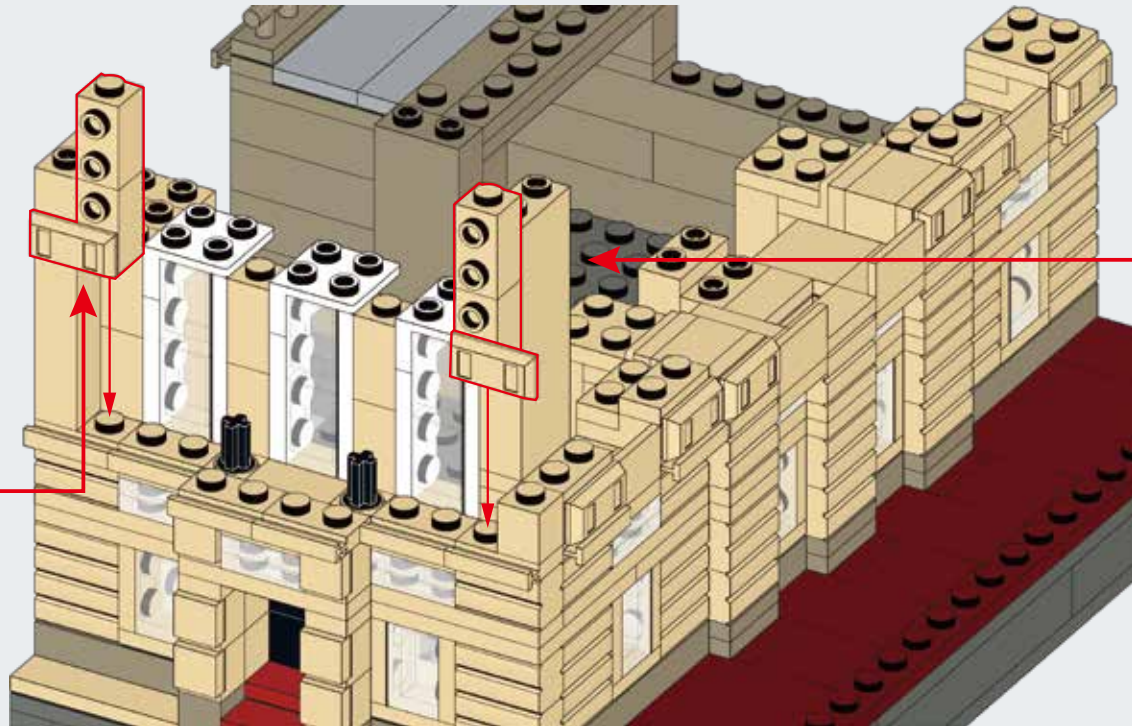
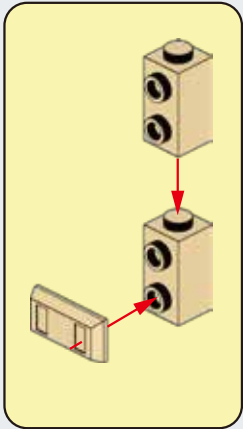

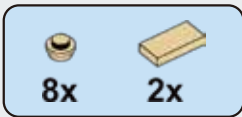

E72

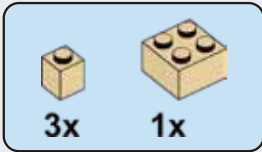
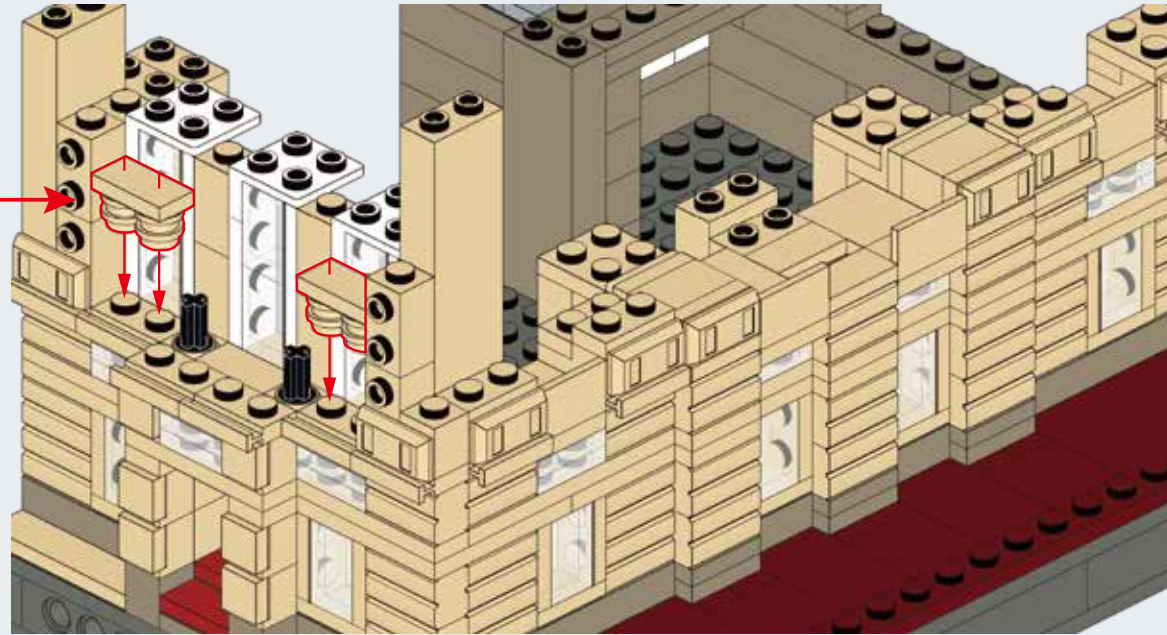
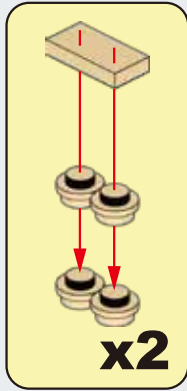

E73

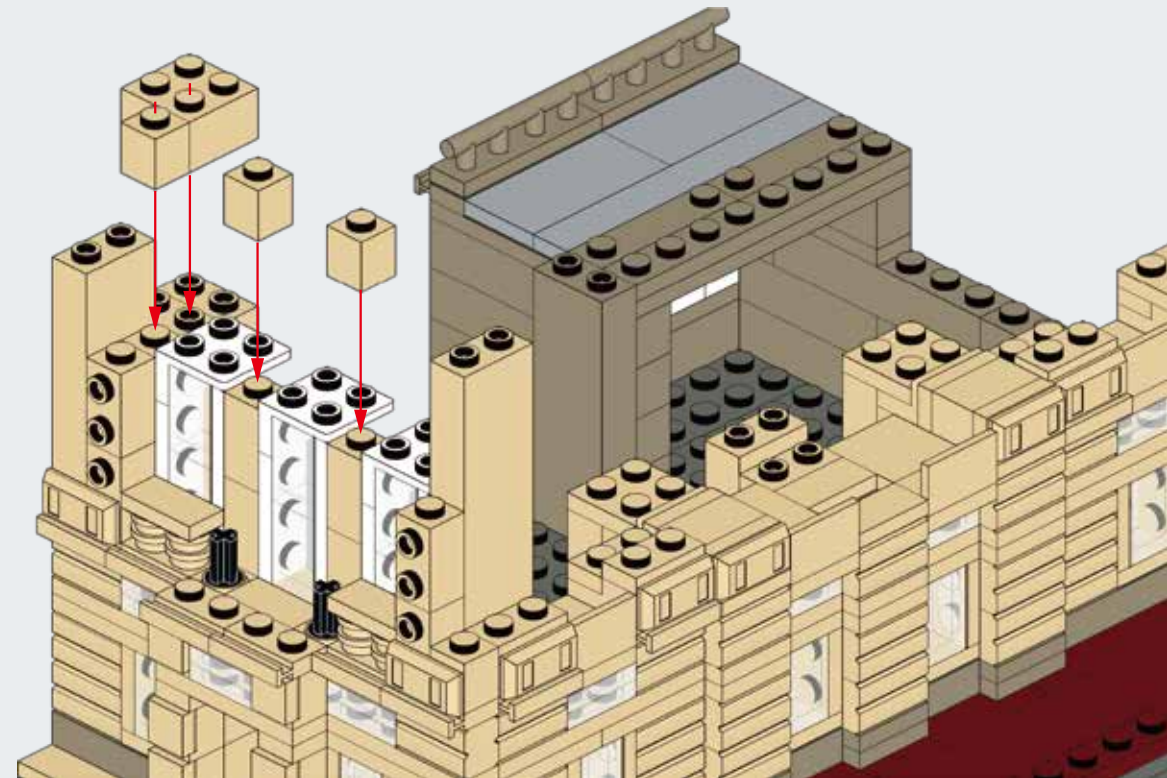

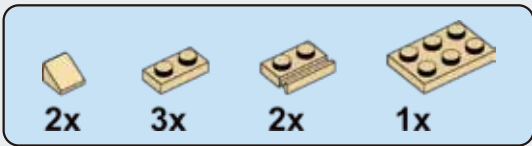

E74

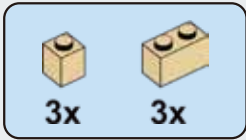
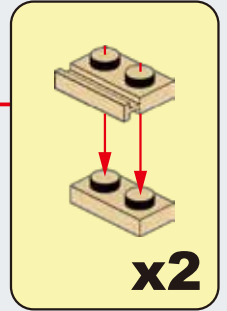
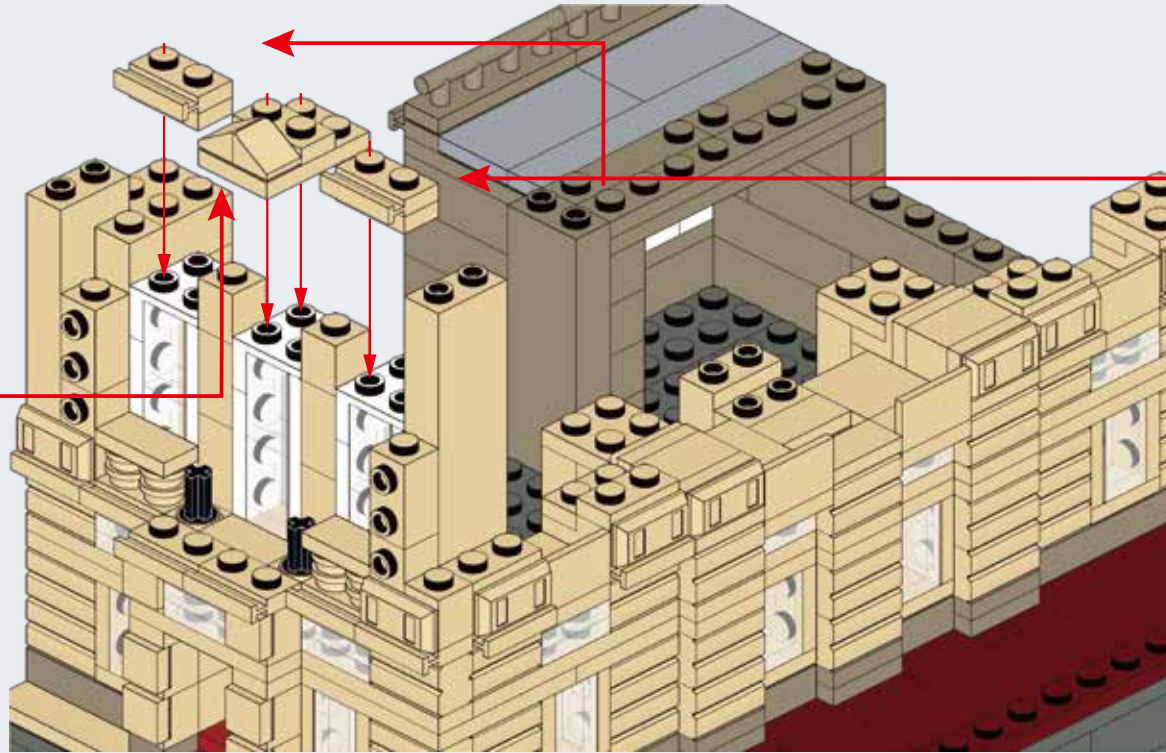
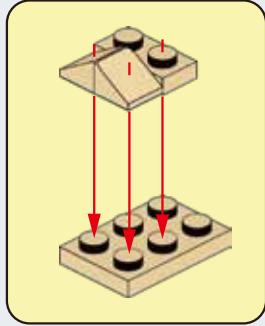

E75

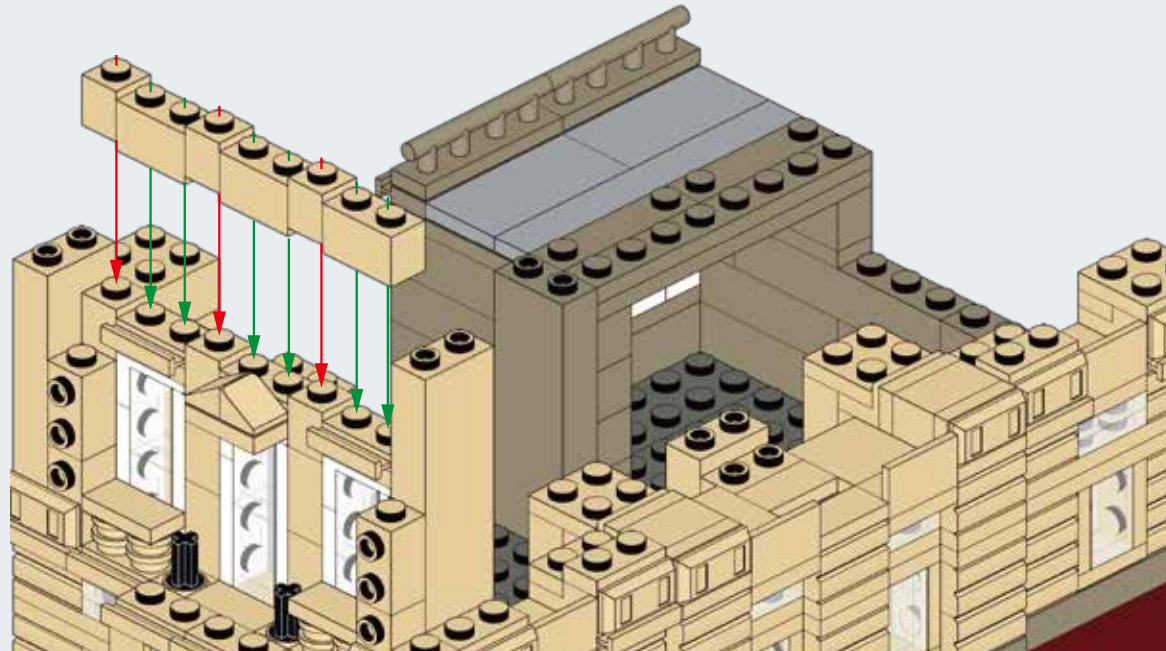



E76

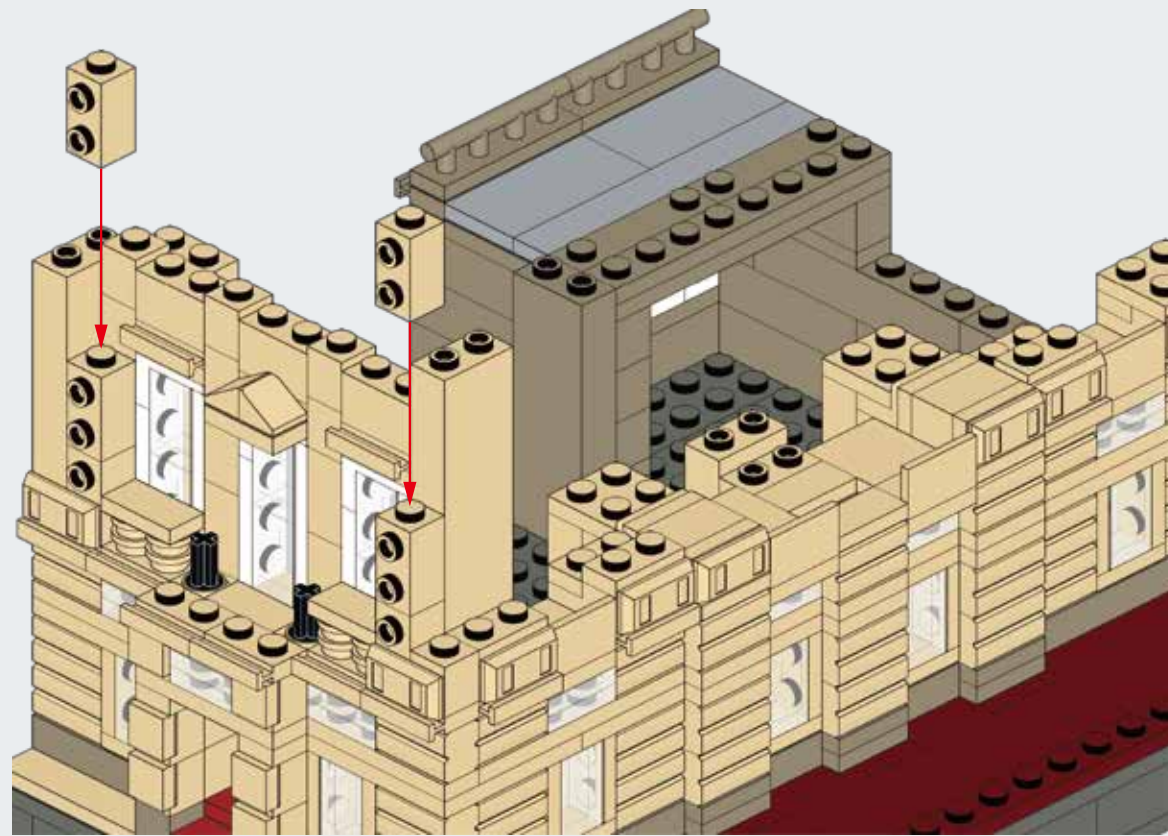

E77

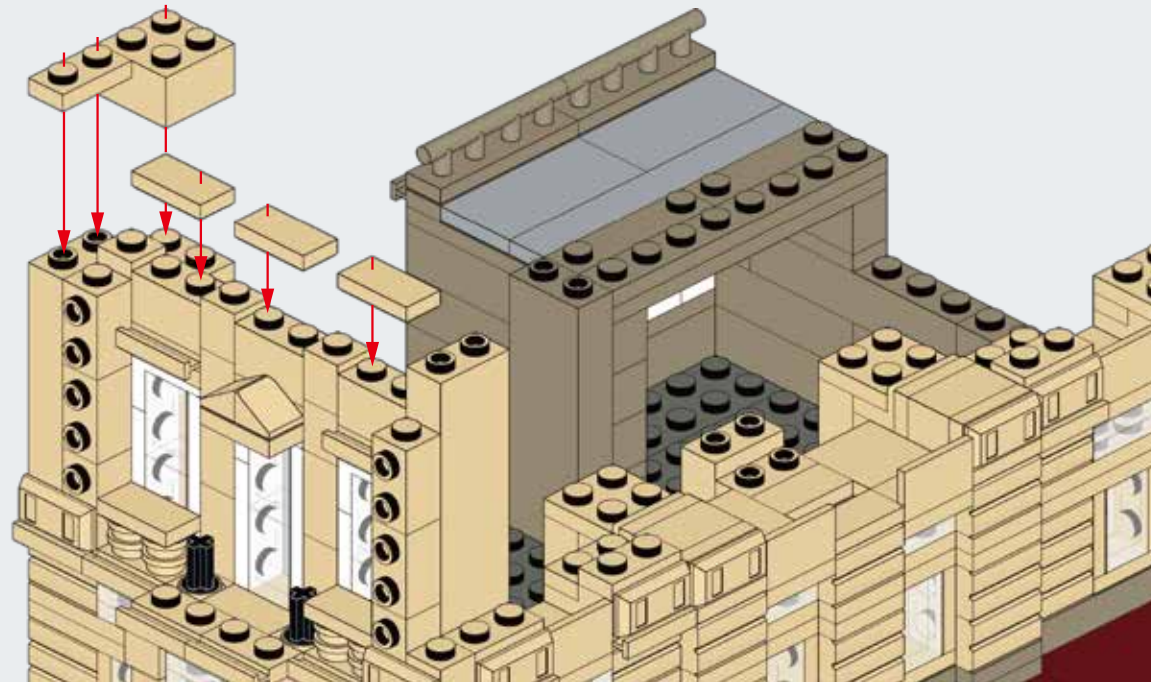

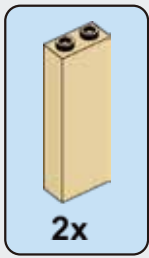

E78

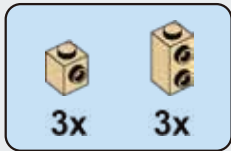
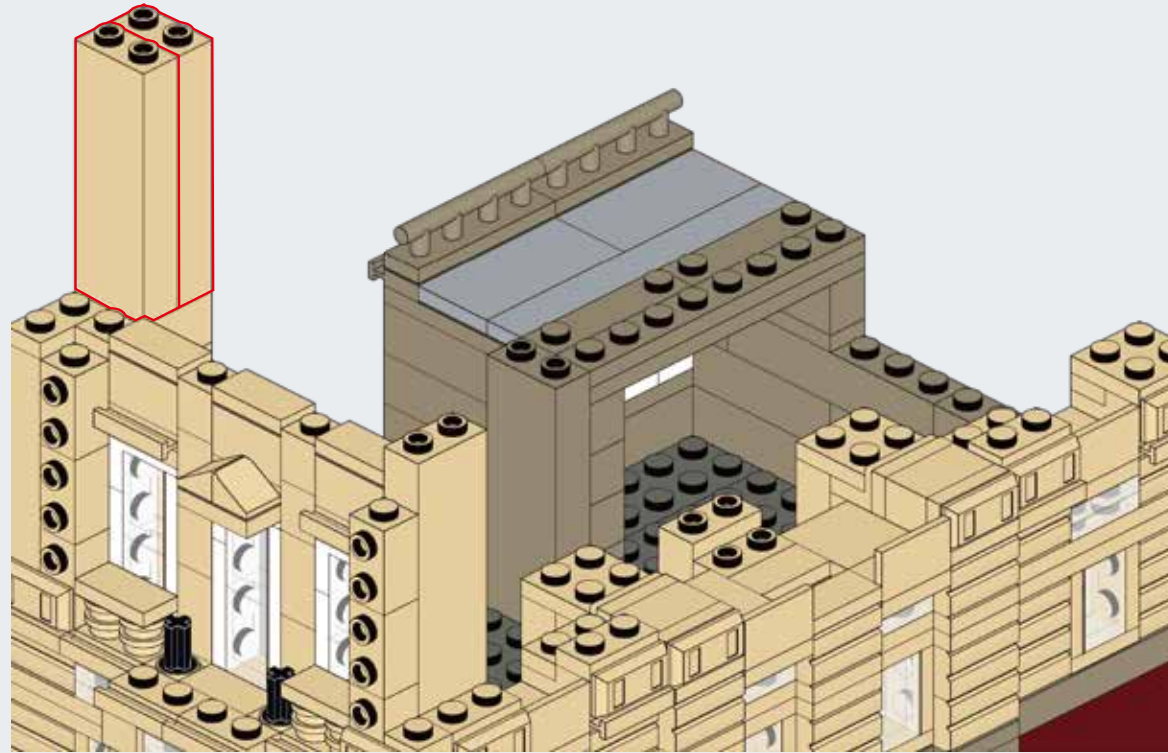

E79

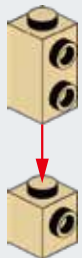

x3

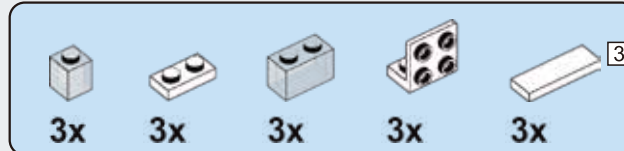

E80

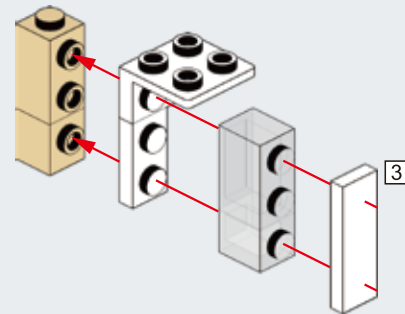

x3



E81

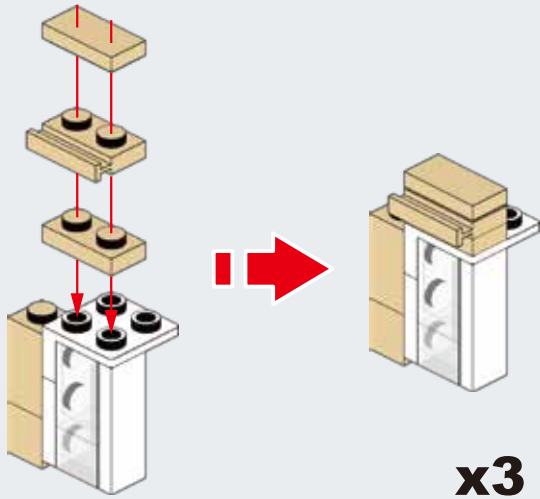

E82

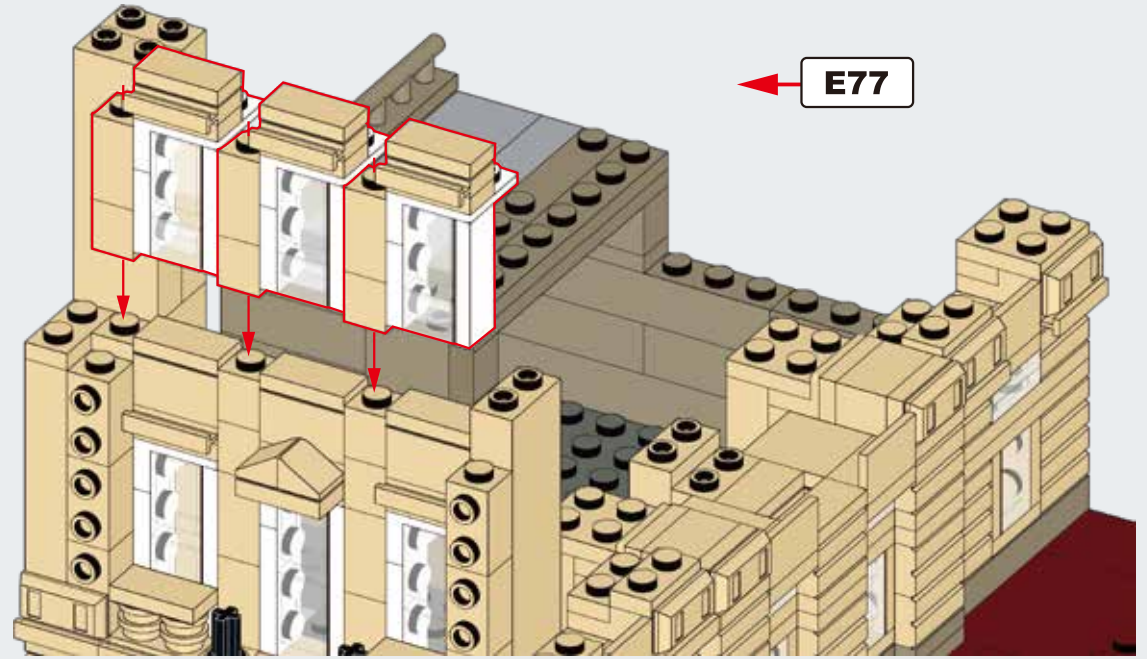

E83

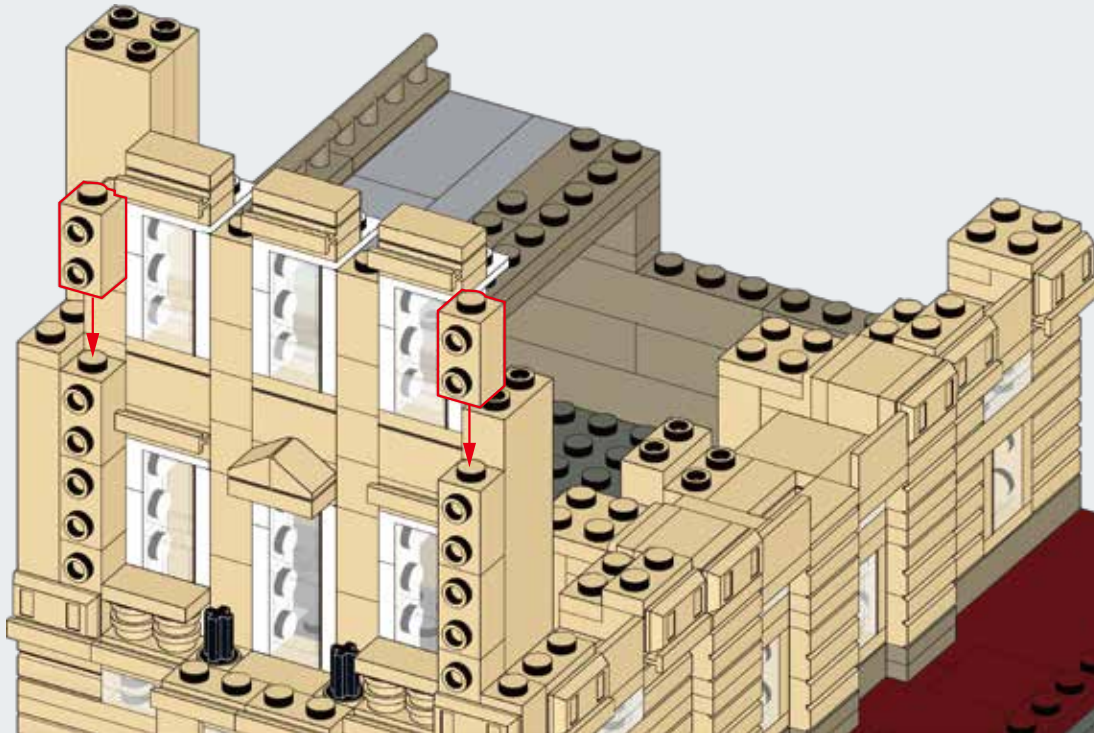

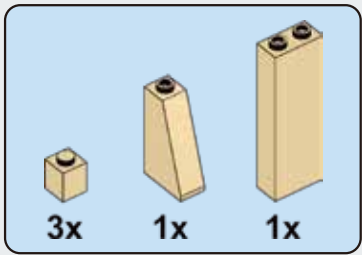

E84

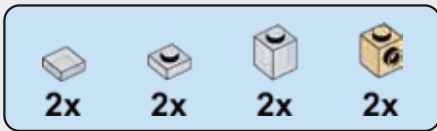
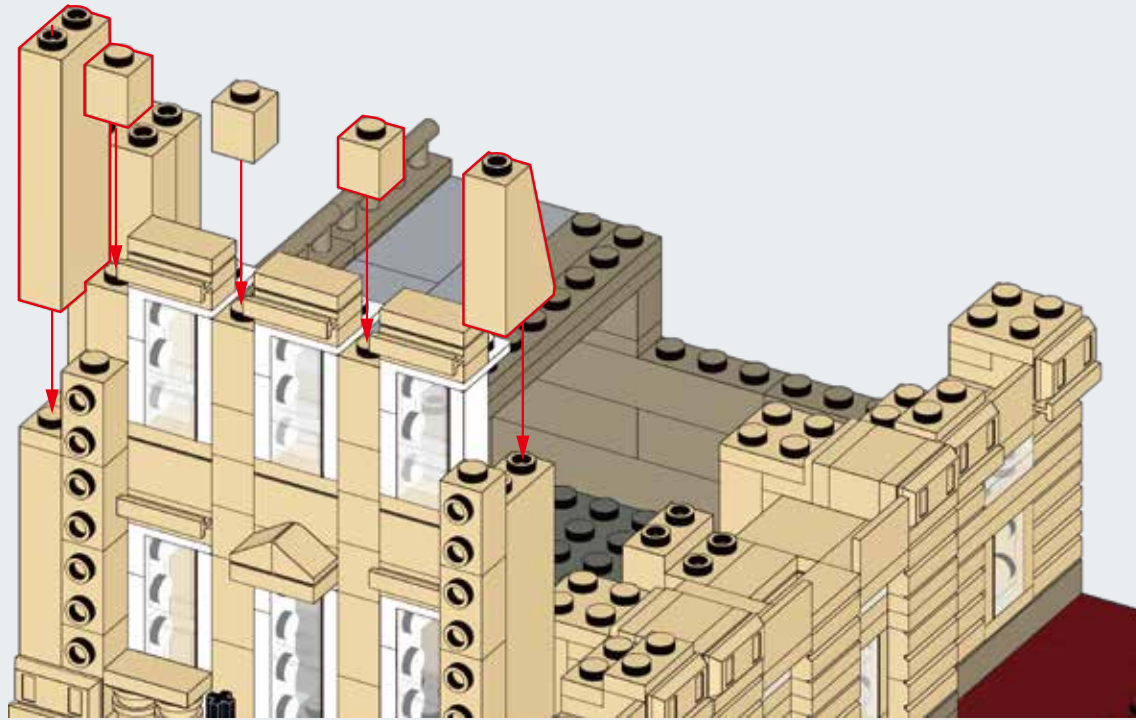

E85

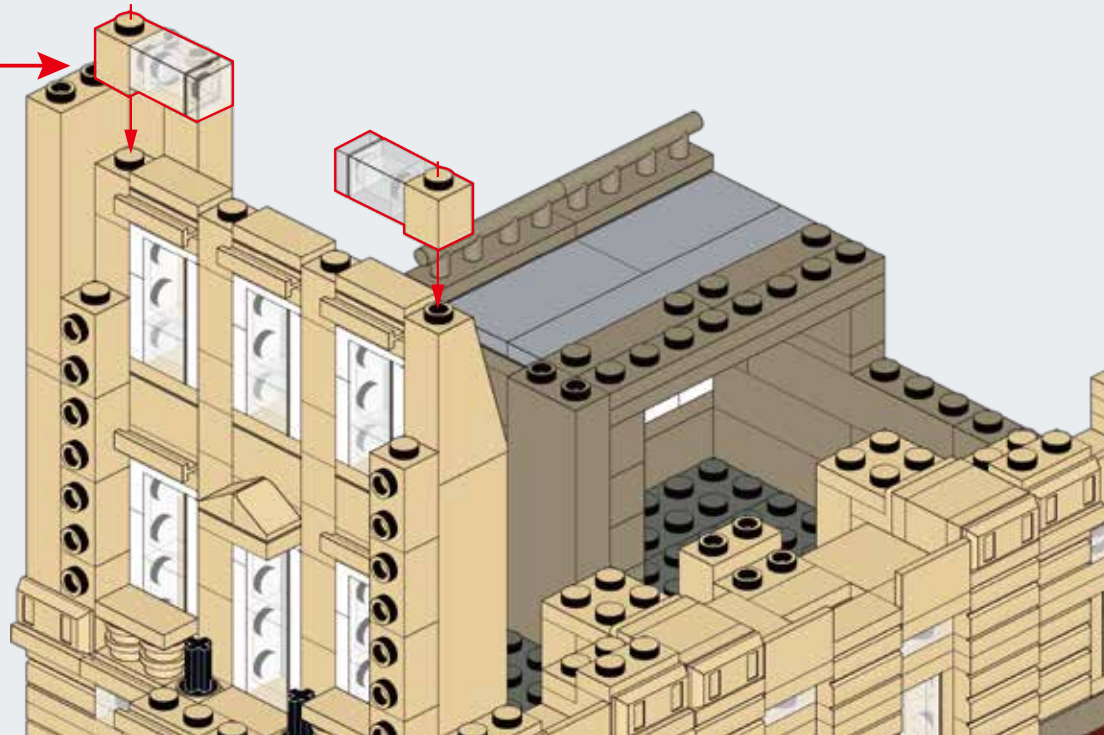
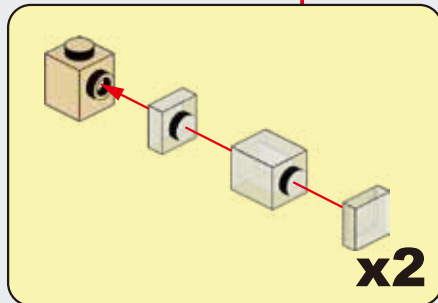



E86

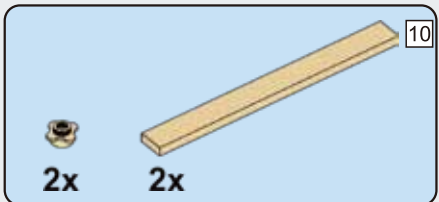
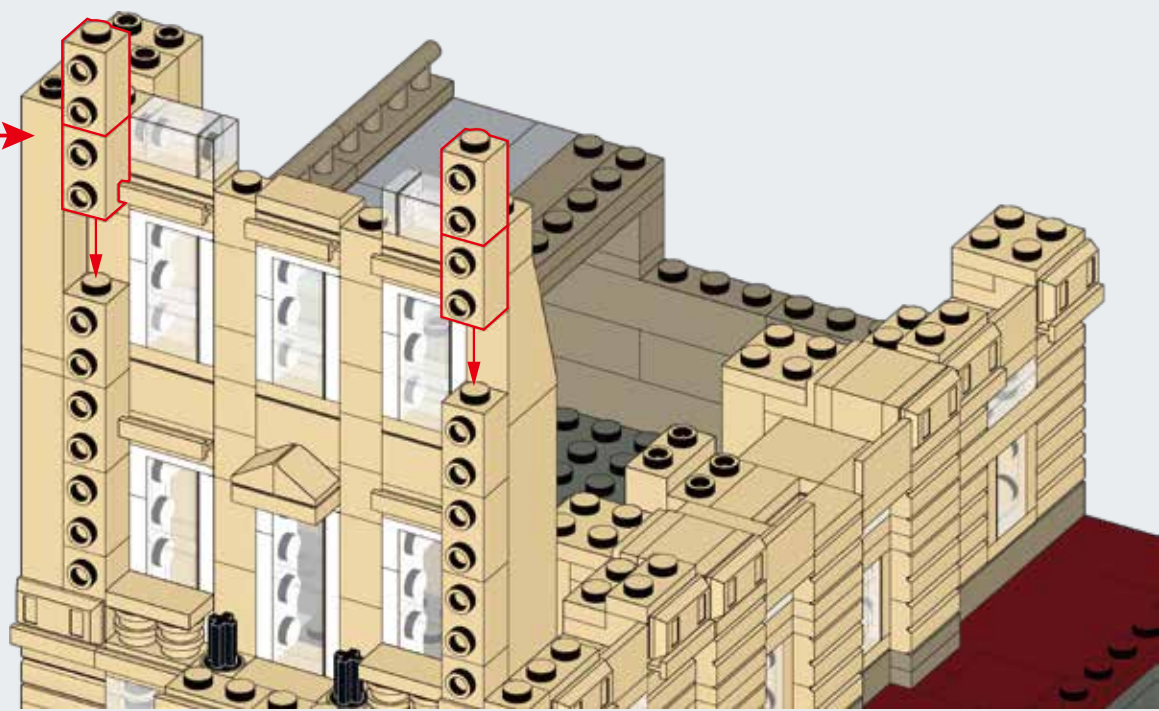
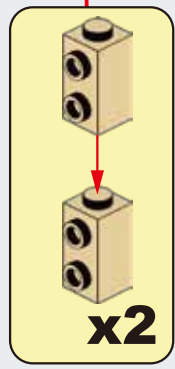

E87

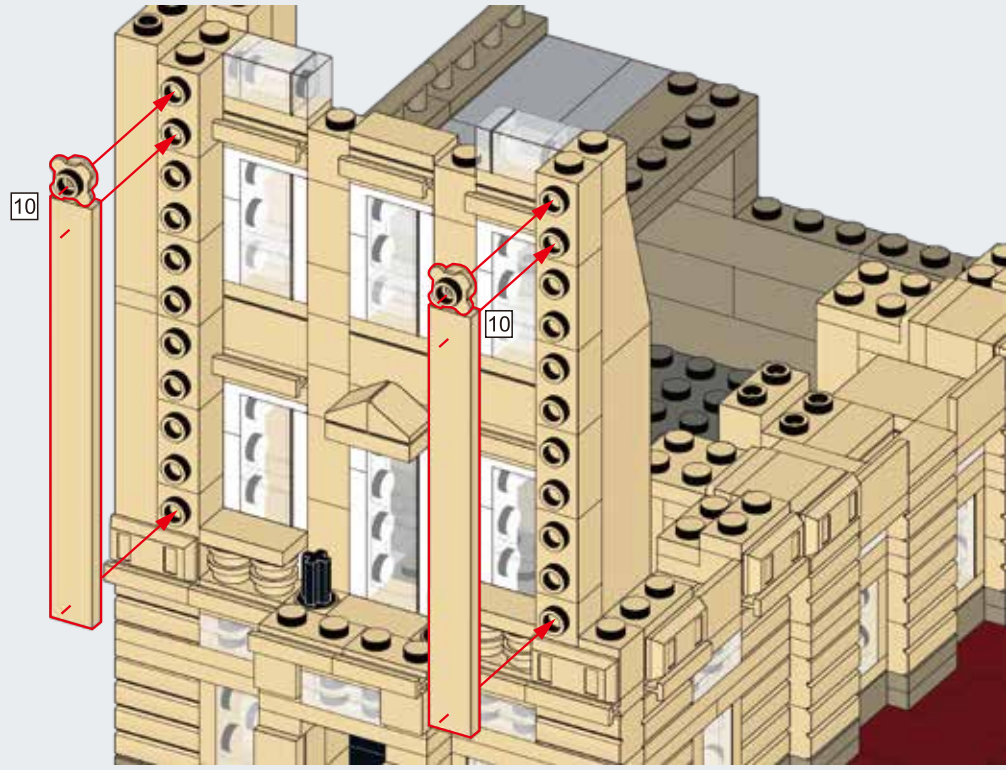

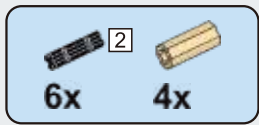

E88

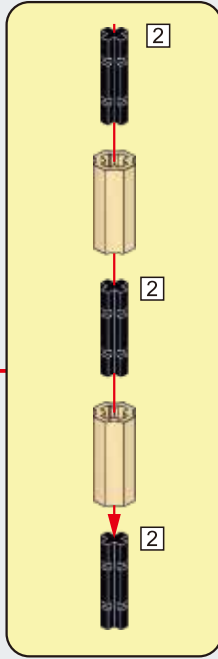

x2

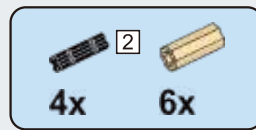

E89

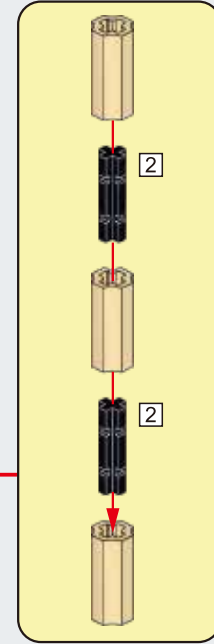
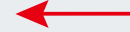

x2

E90

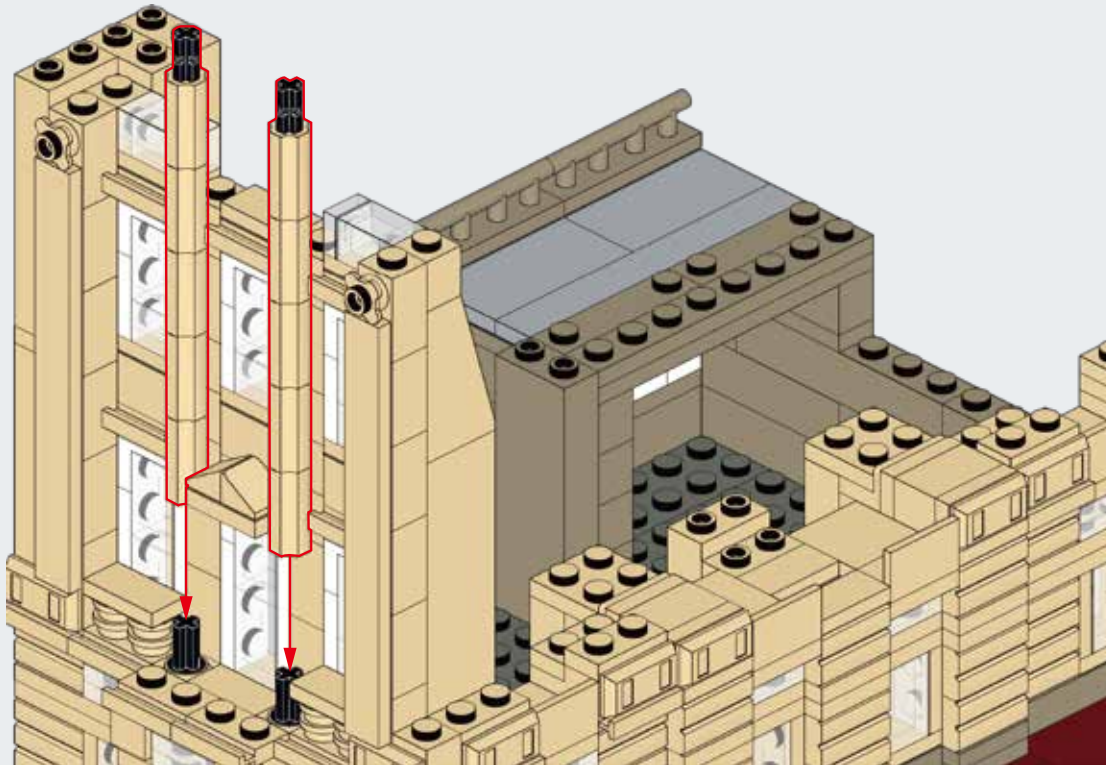

E87





E91

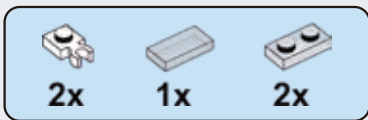
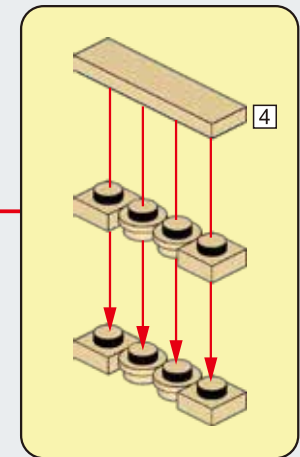
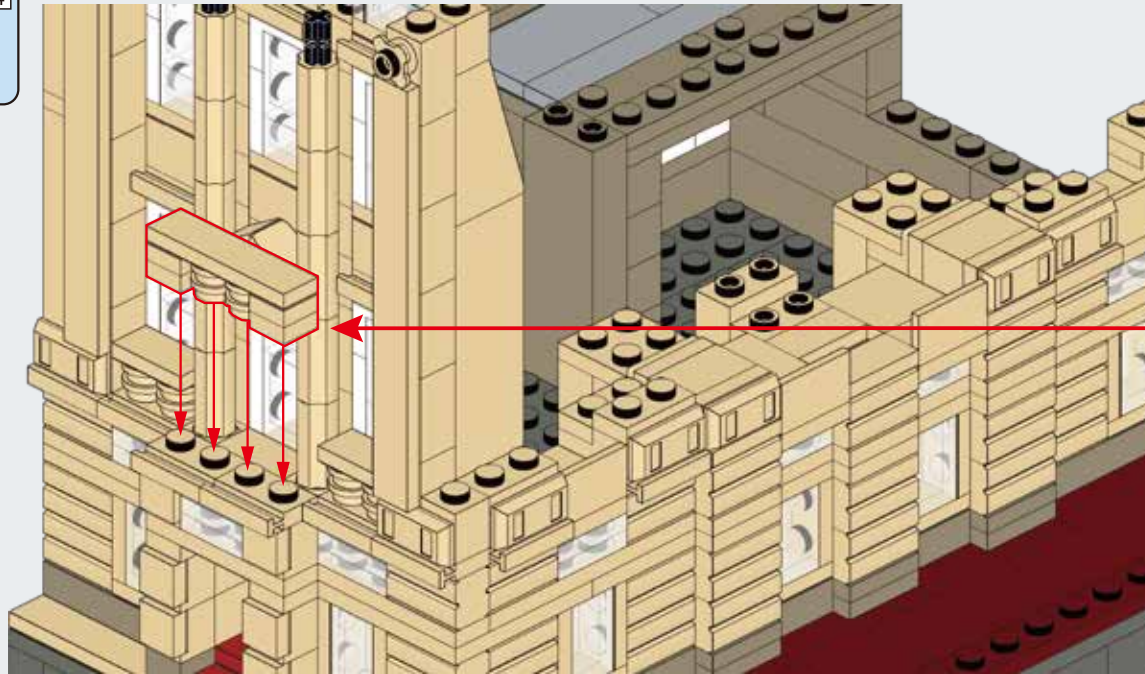

E92

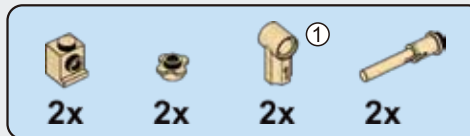
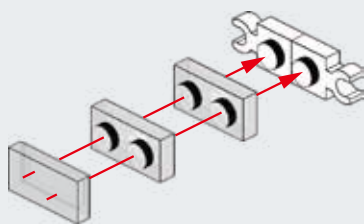

E93

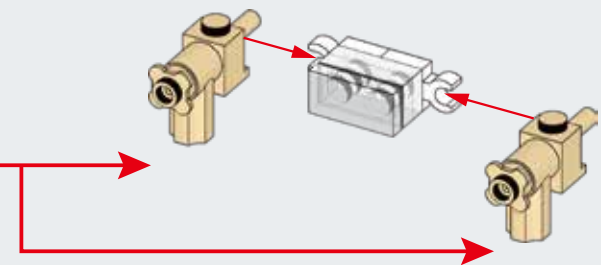
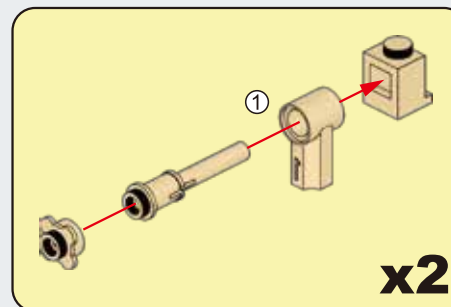

E94

E91 →

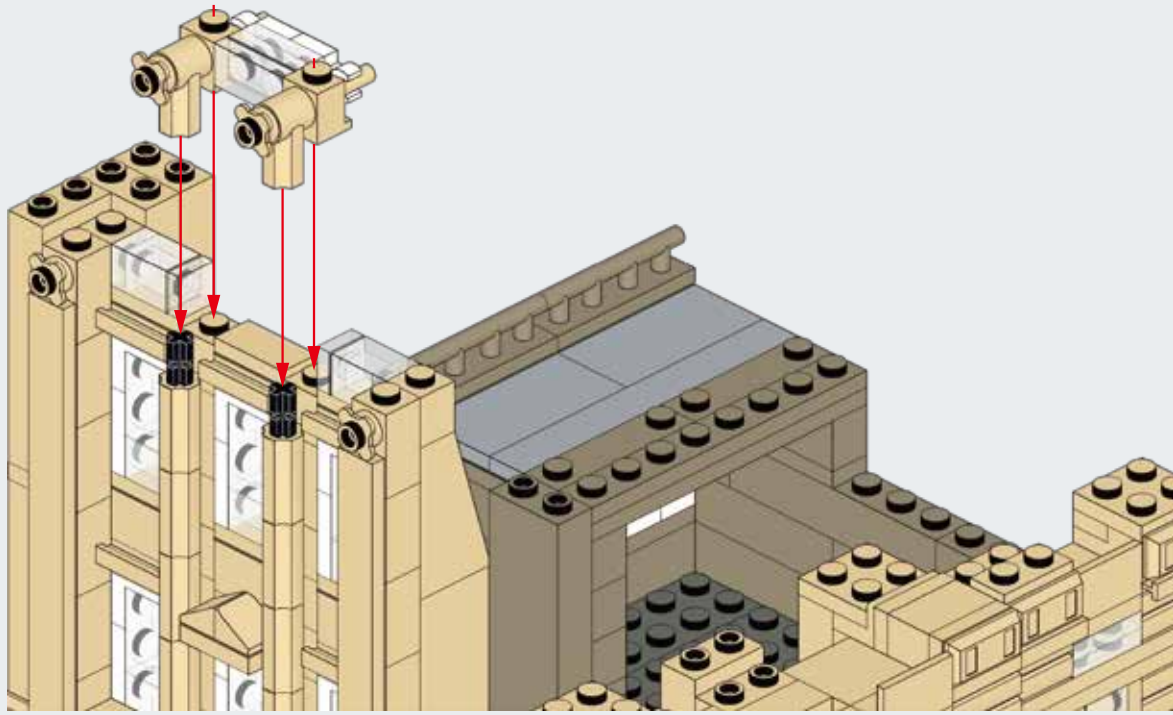

E95

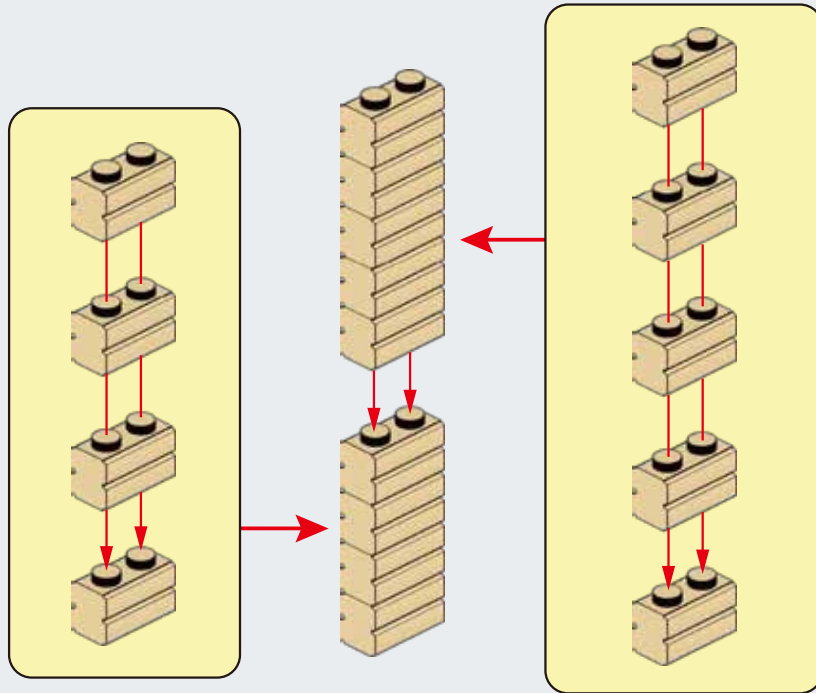

E96

E94

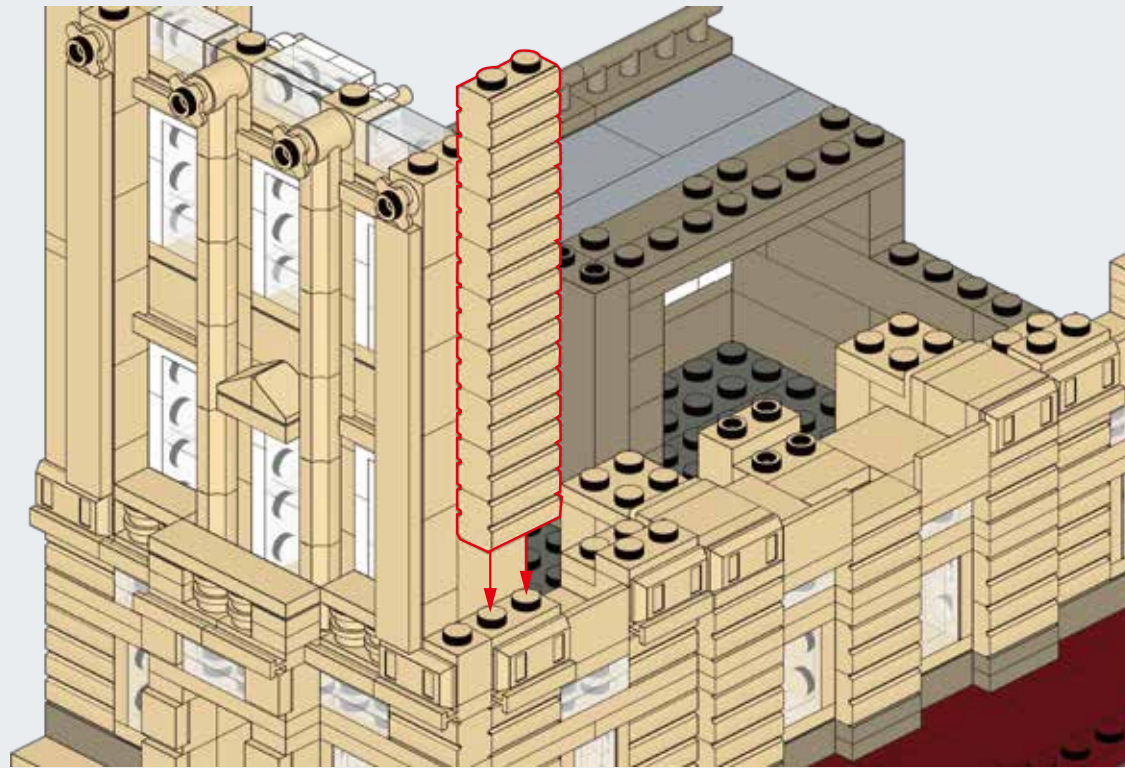

E97

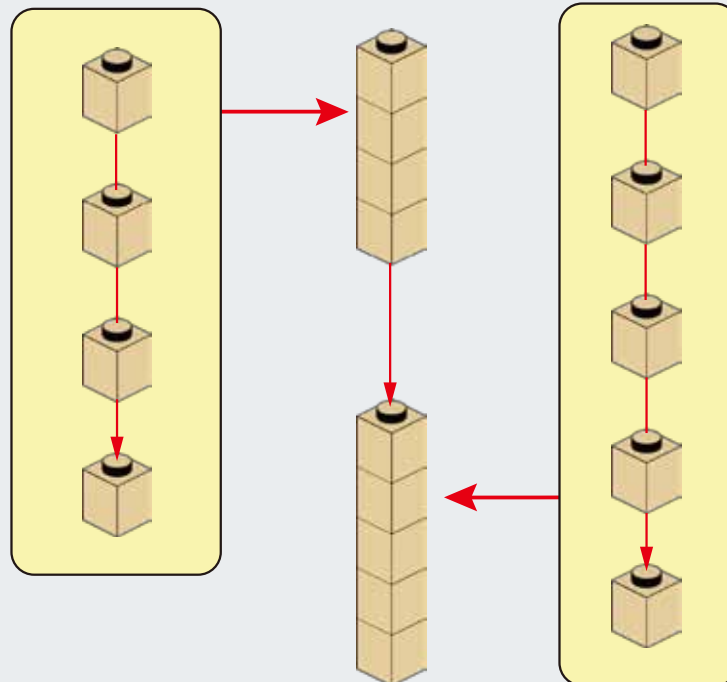

E98

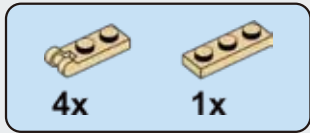
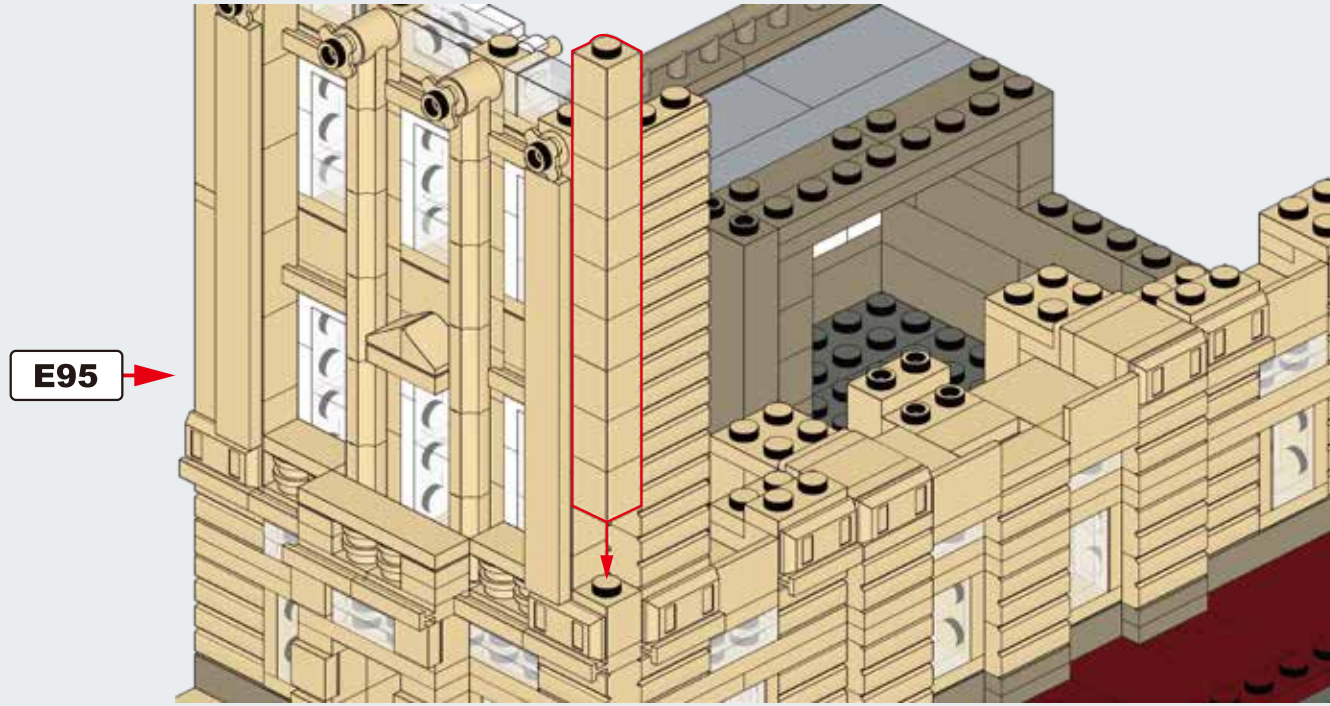

E99

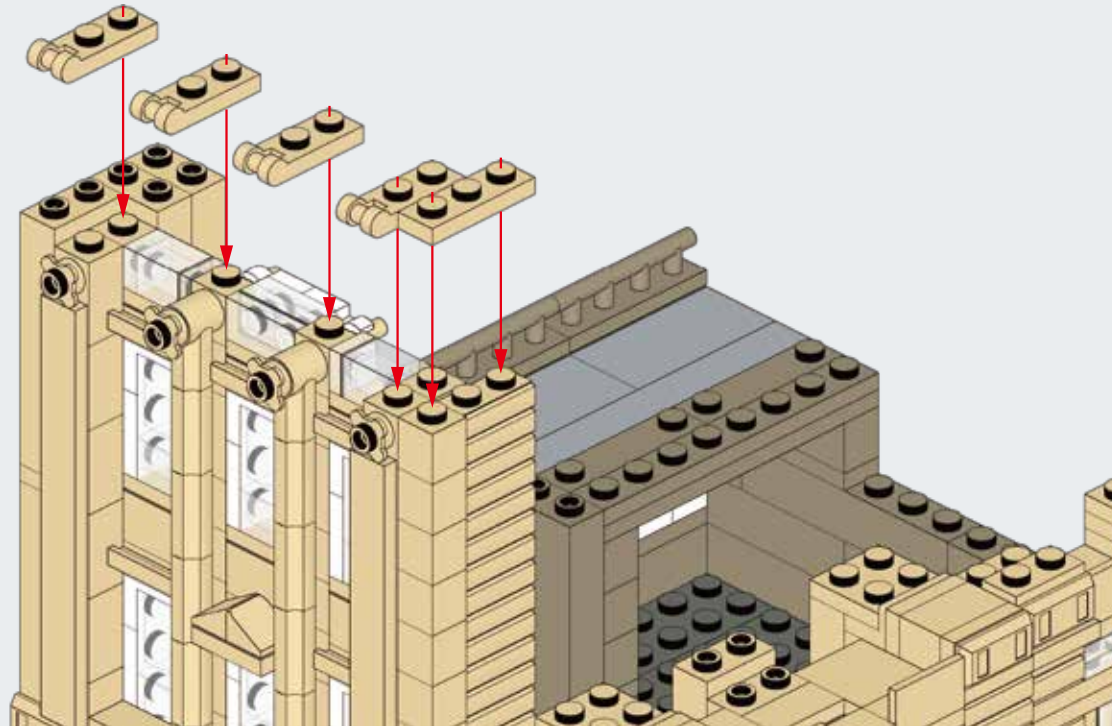

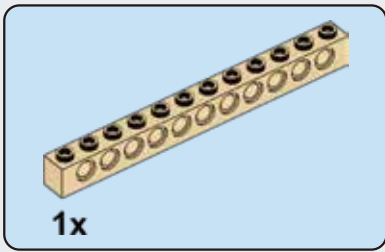

E100

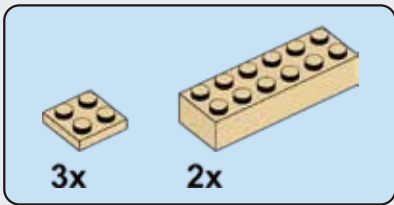
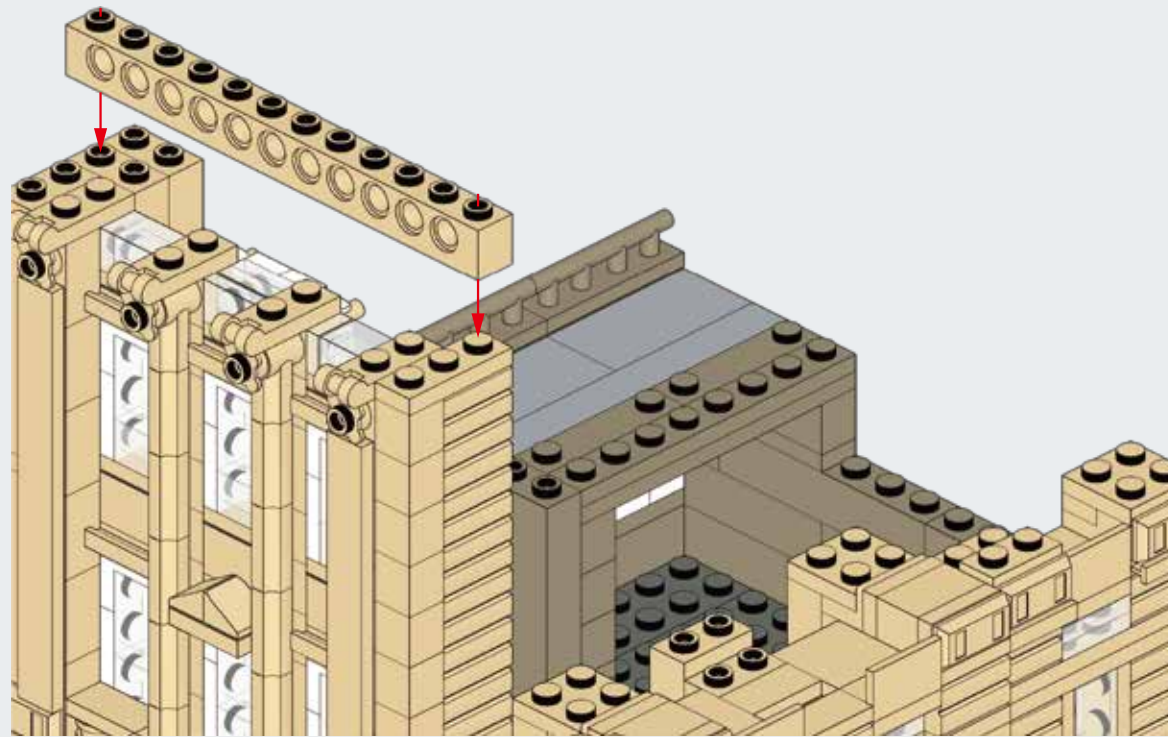

E101

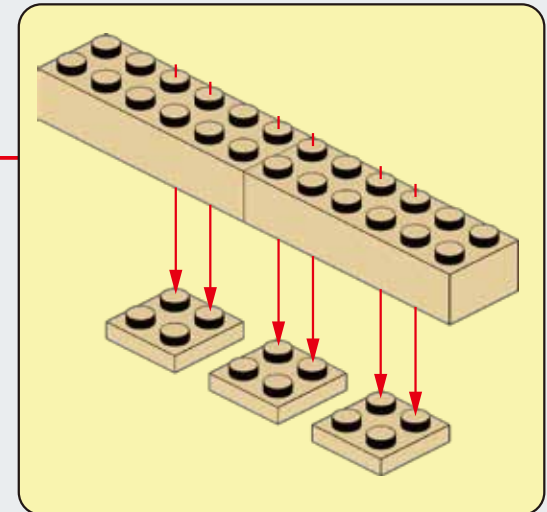
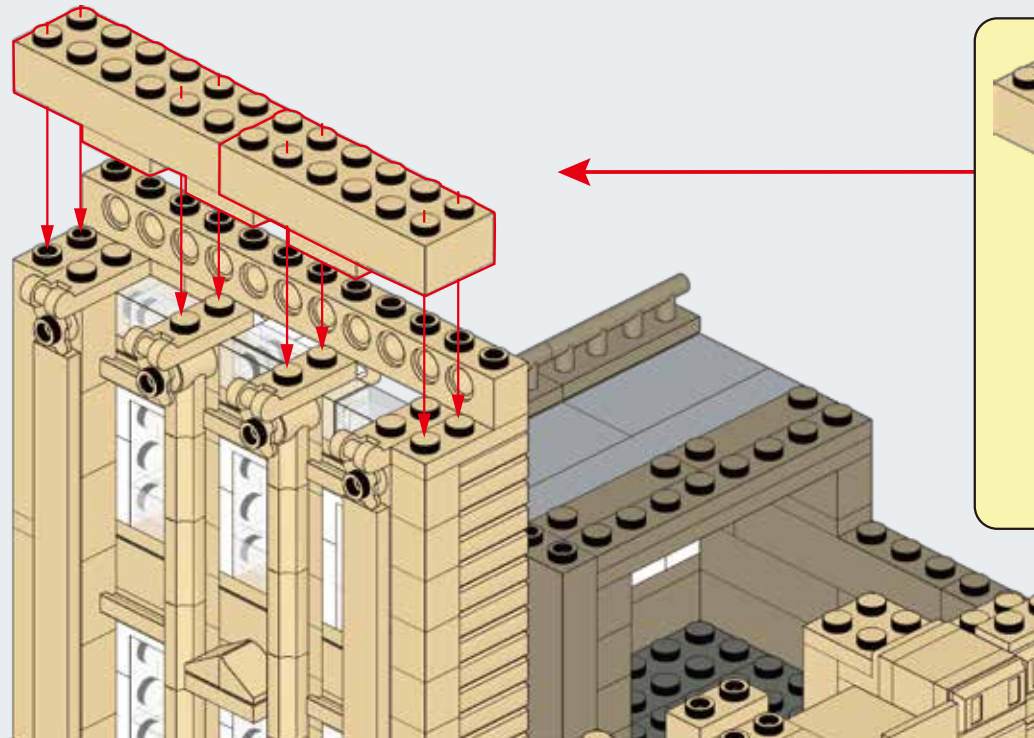

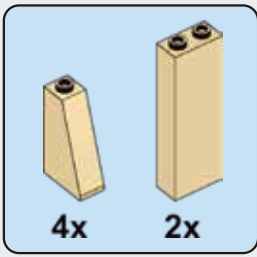

E102

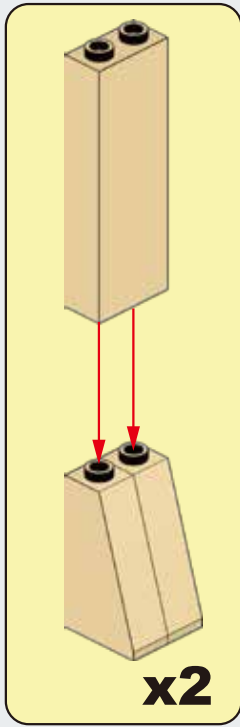

x2

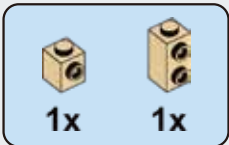
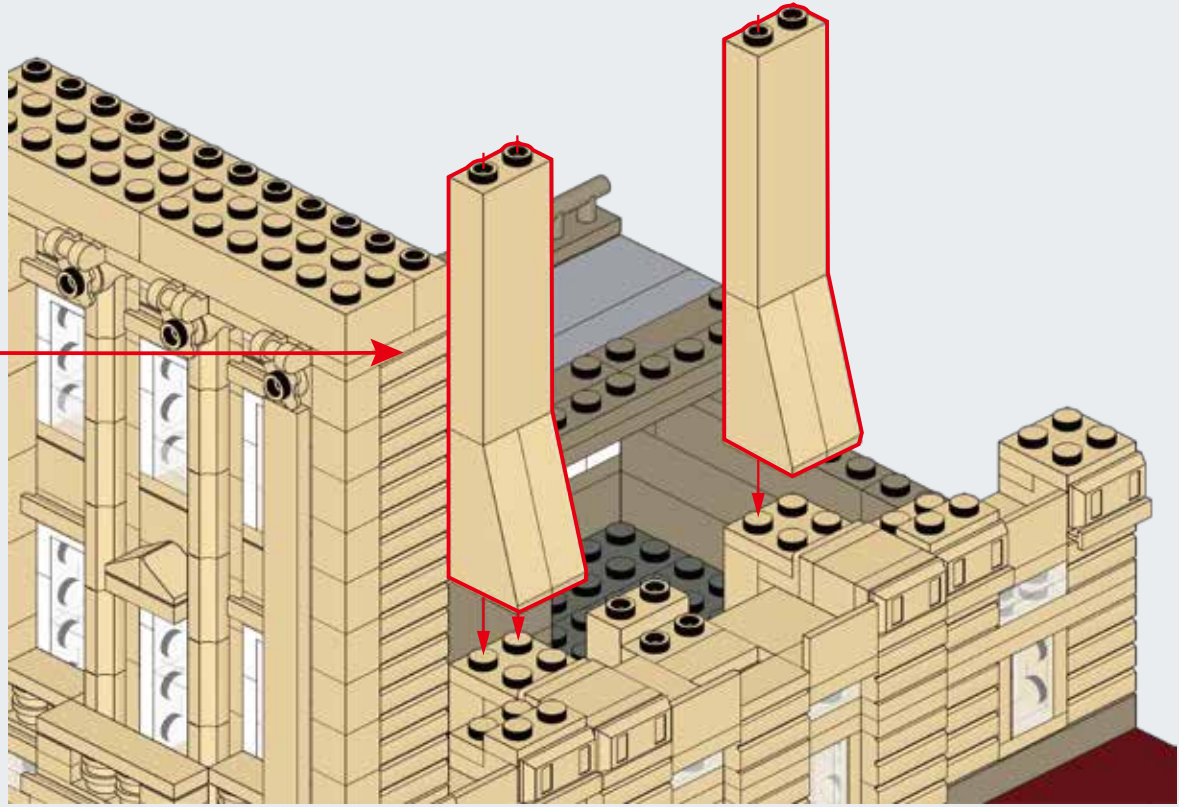

E103

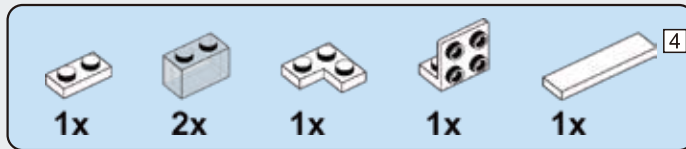

E104

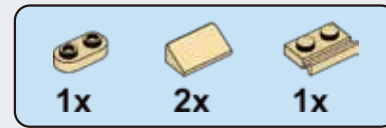
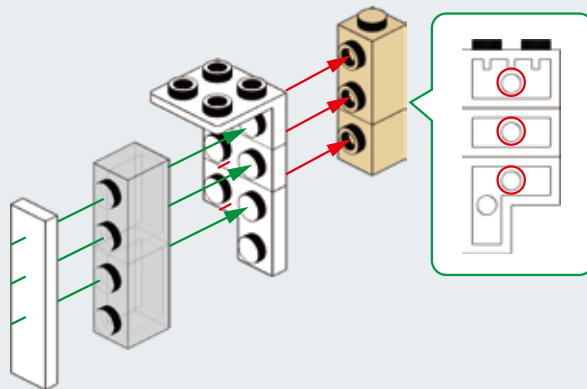

E105

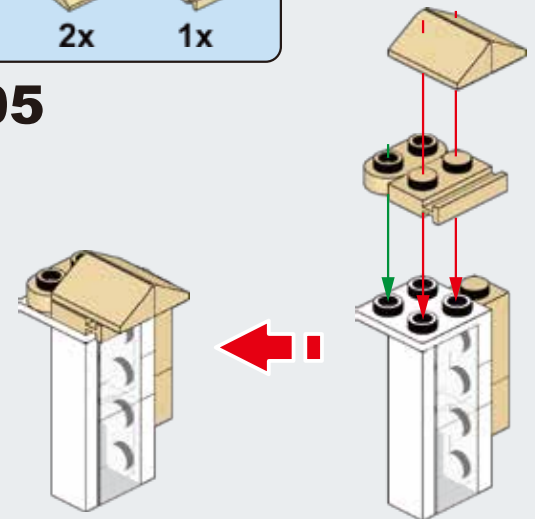

E106

A101

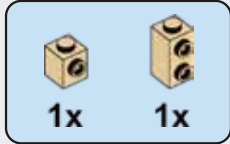
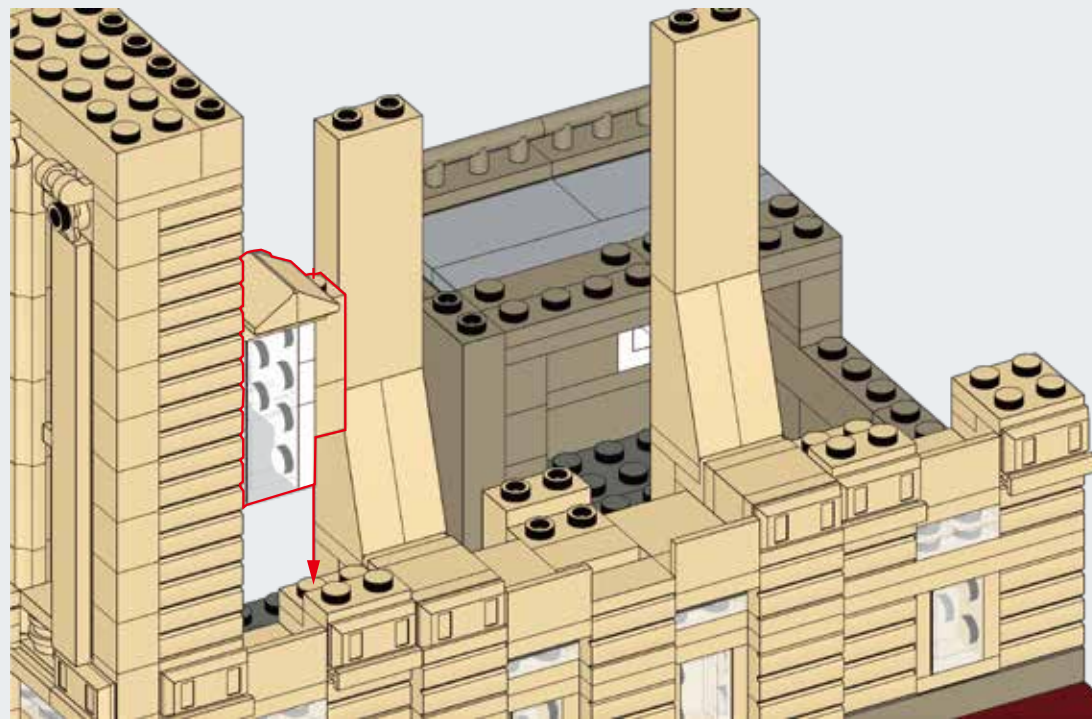

E107

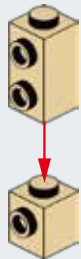

E108

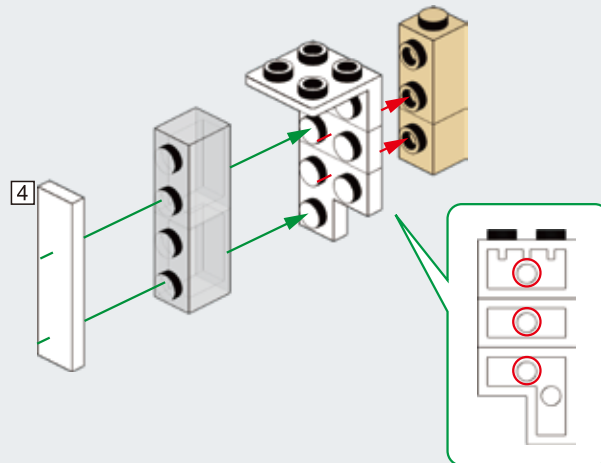

E109

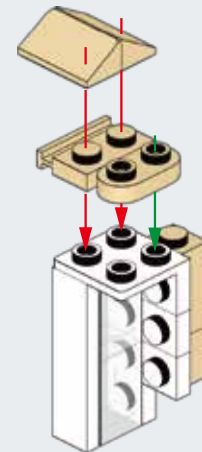
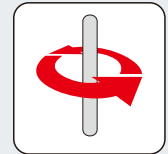

E110

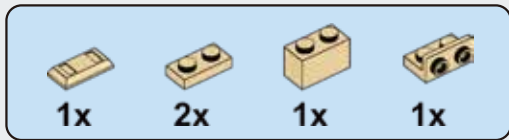
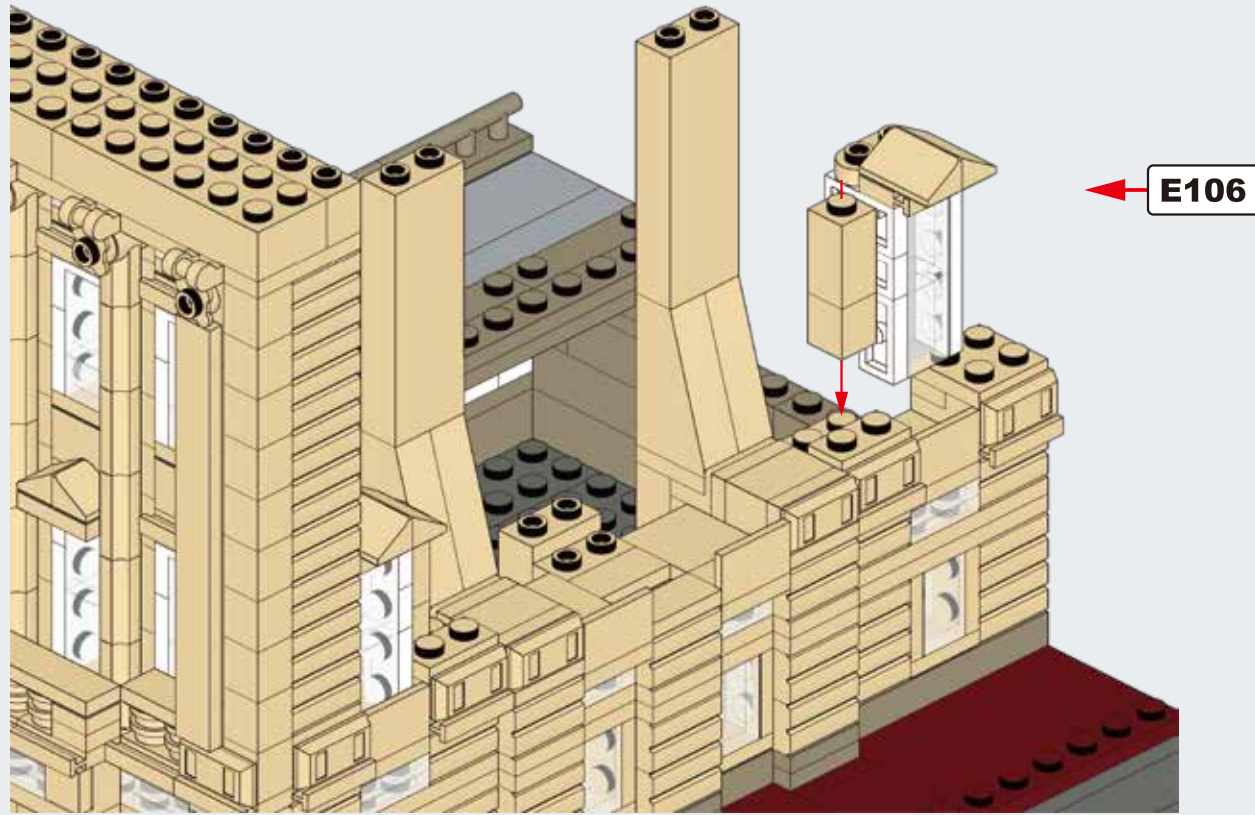

E111

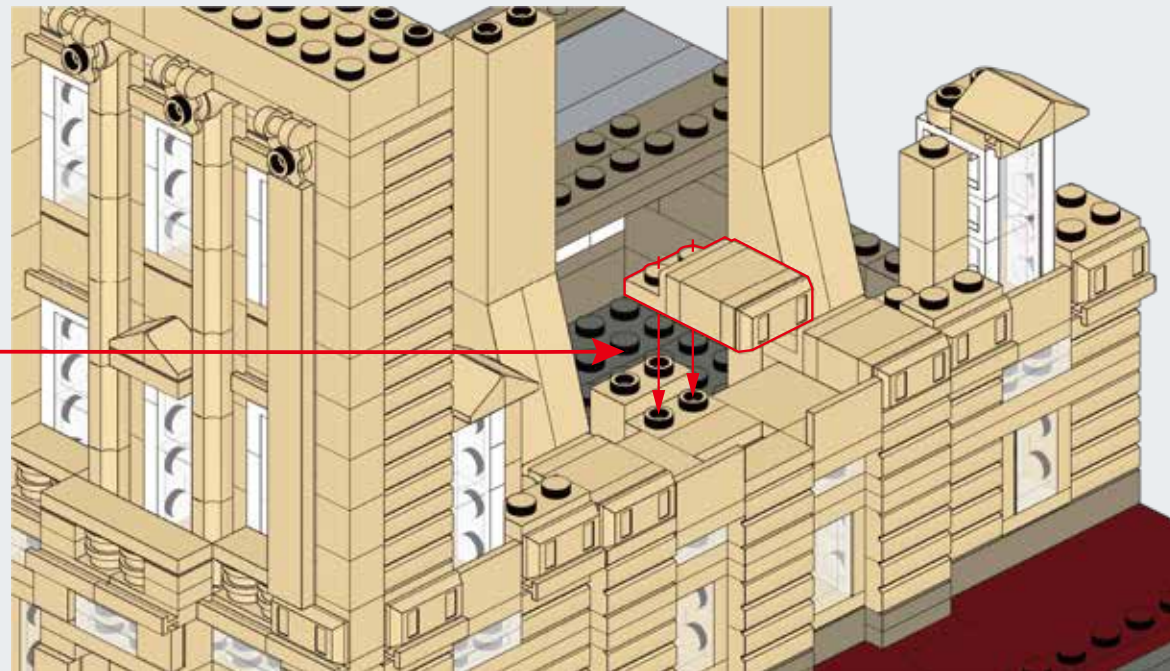
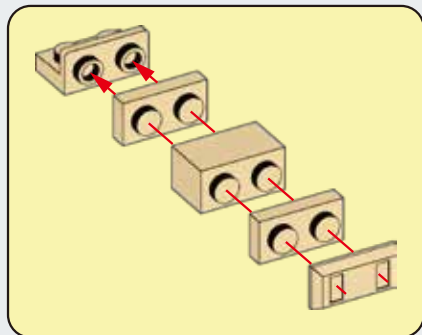

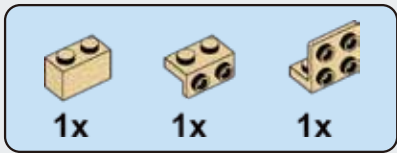

E112

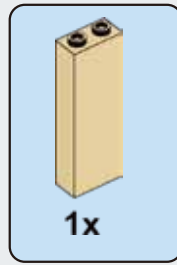
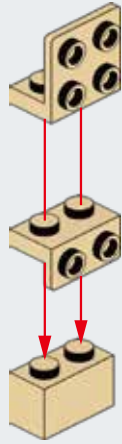

E113

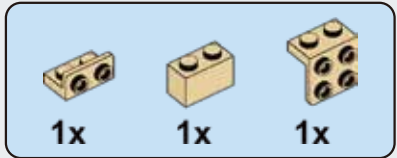

E114

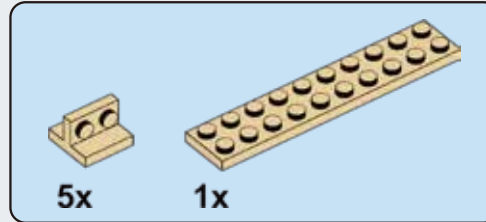
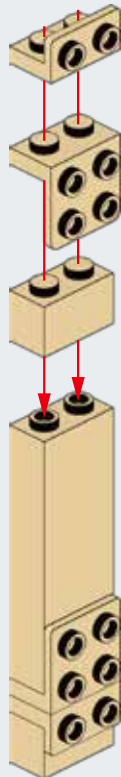

E115

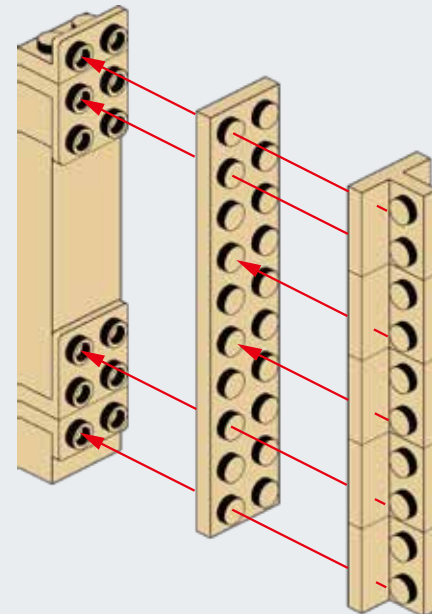

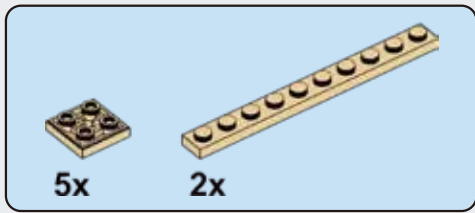

E116

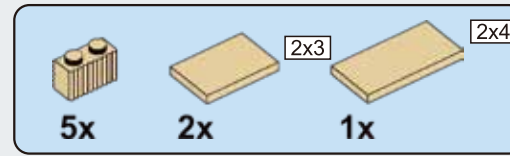
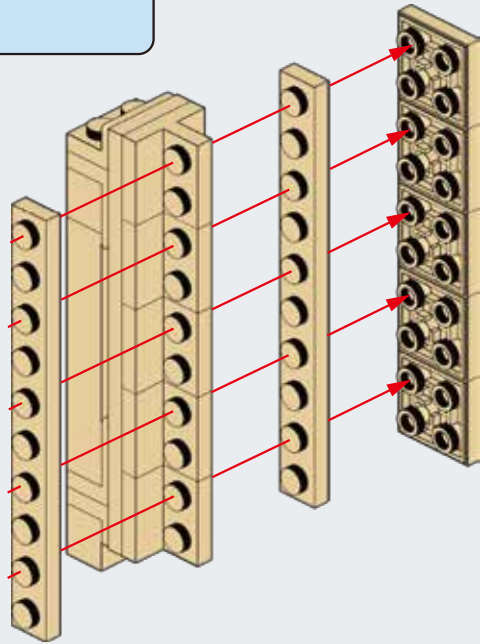

E117

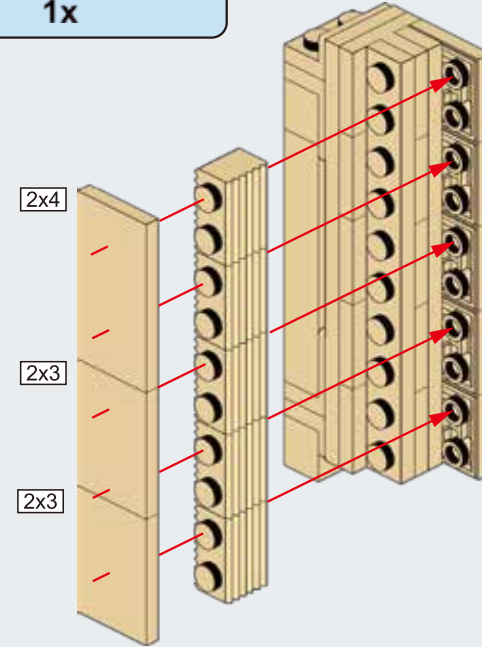

E118

E111 →

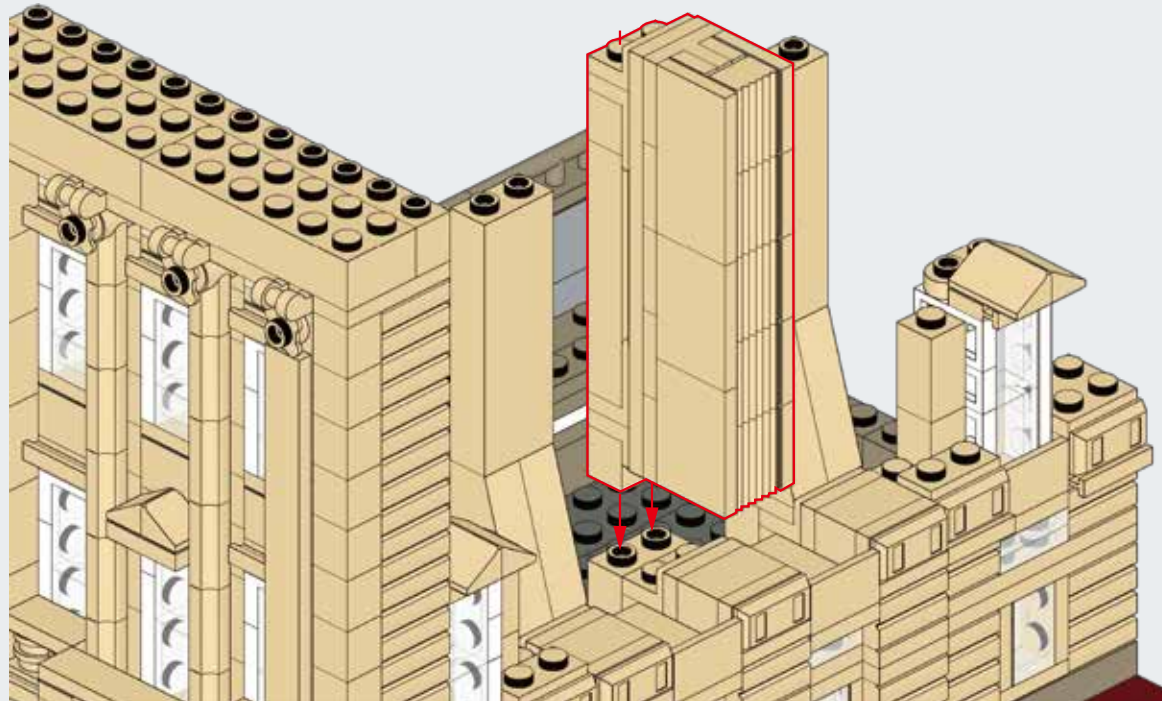



E119

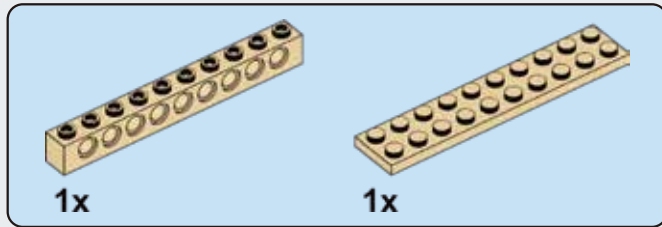
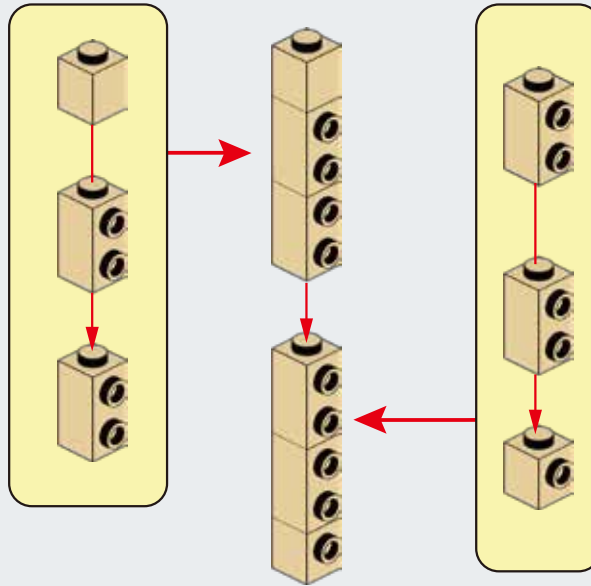

E120

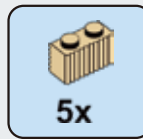
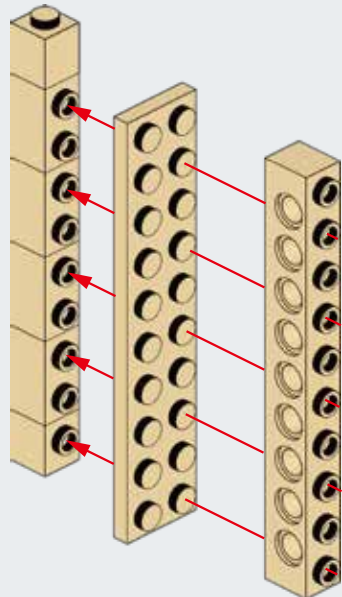

E121

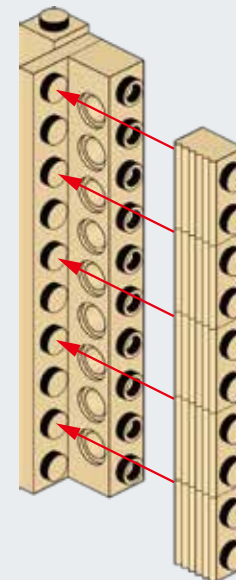

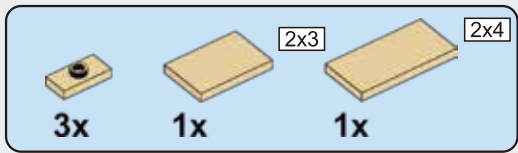

E122

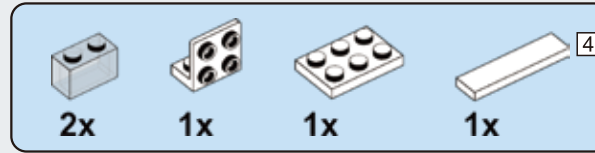
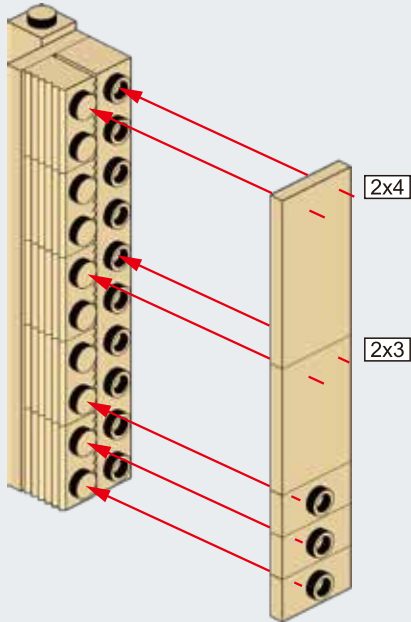

E123

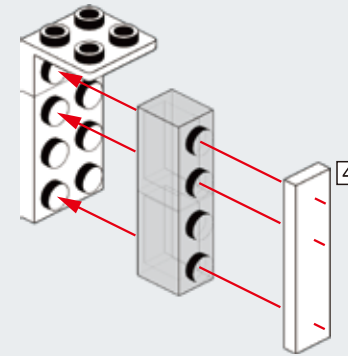

E124

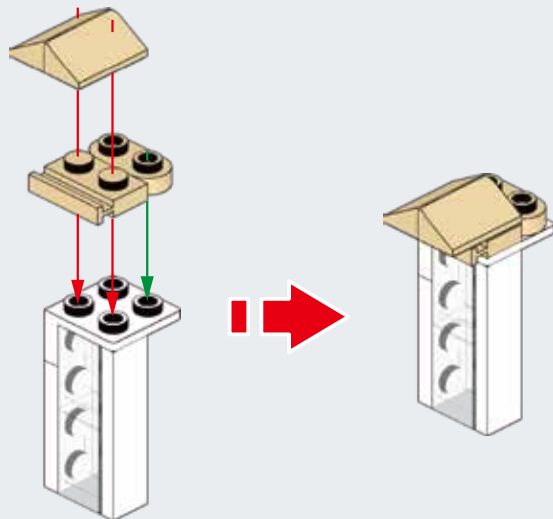

E125

E122 →

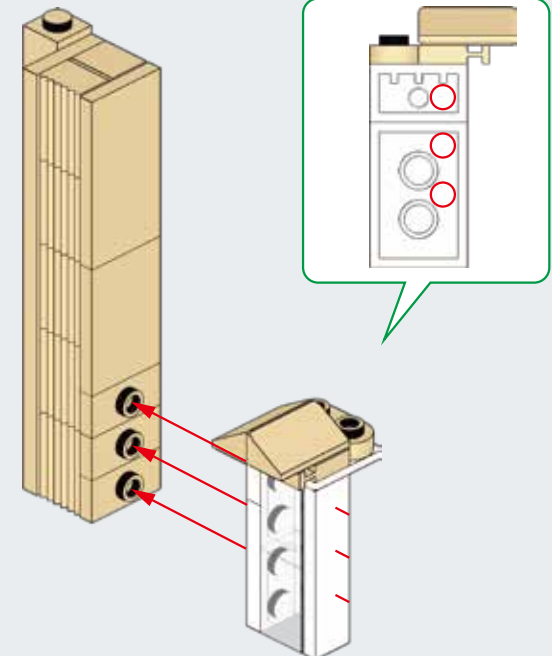

E126



E116

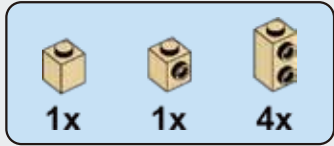
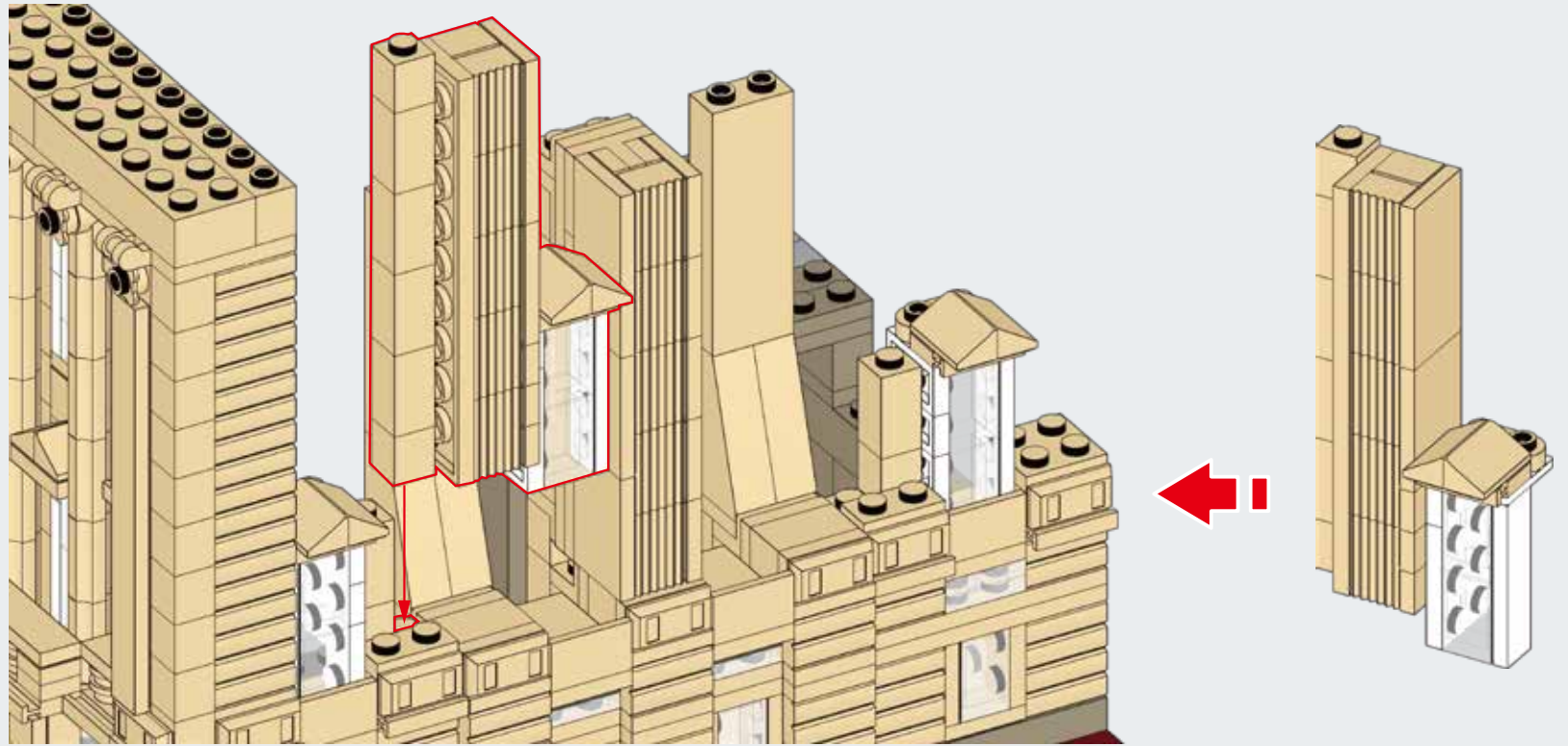

E127

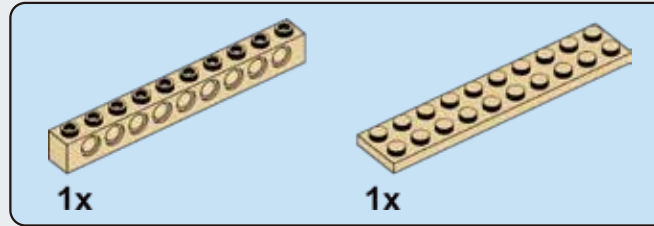
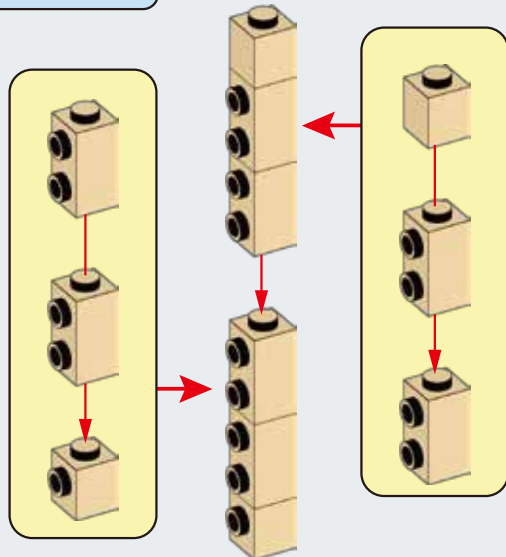

E128

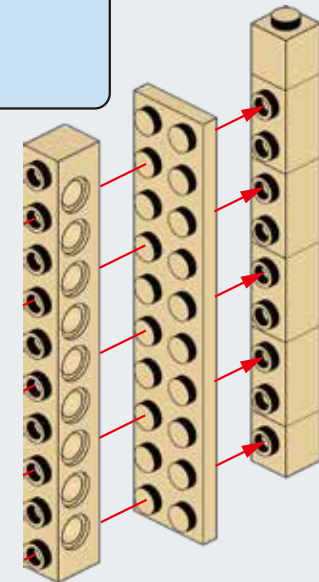



E129

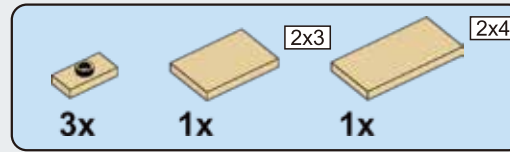
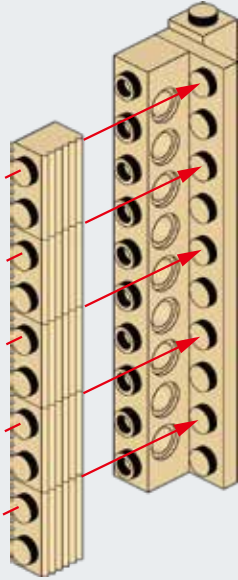

E130

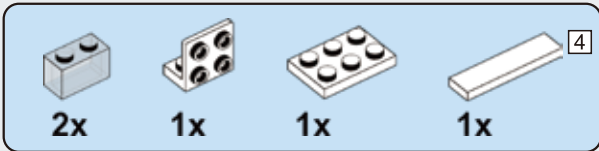
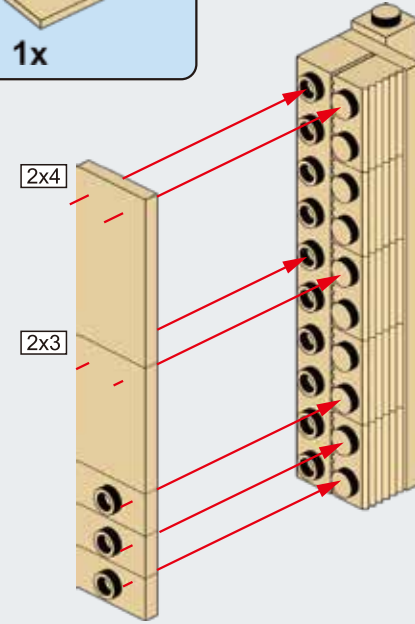

E131

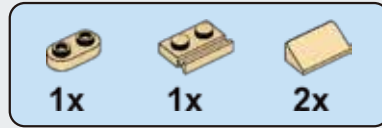
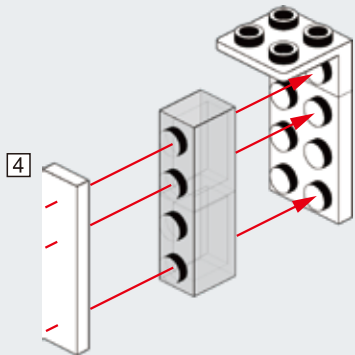

E132

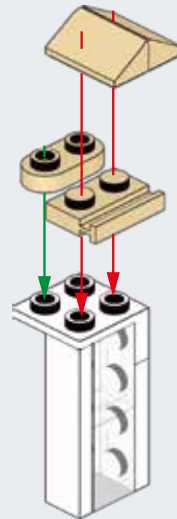

E133

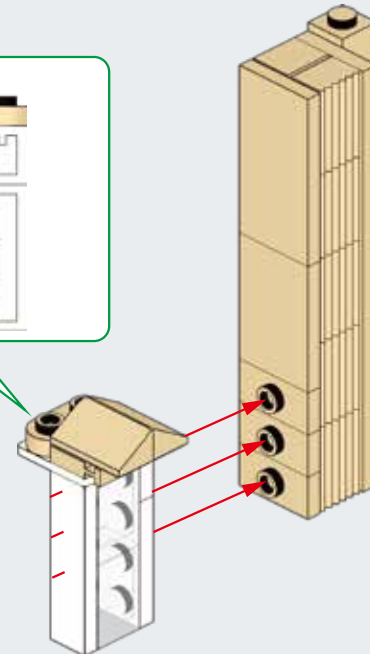
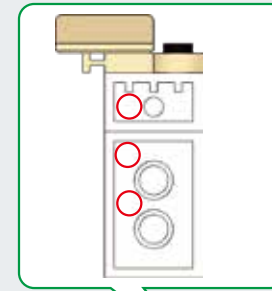

E130

E134

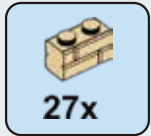
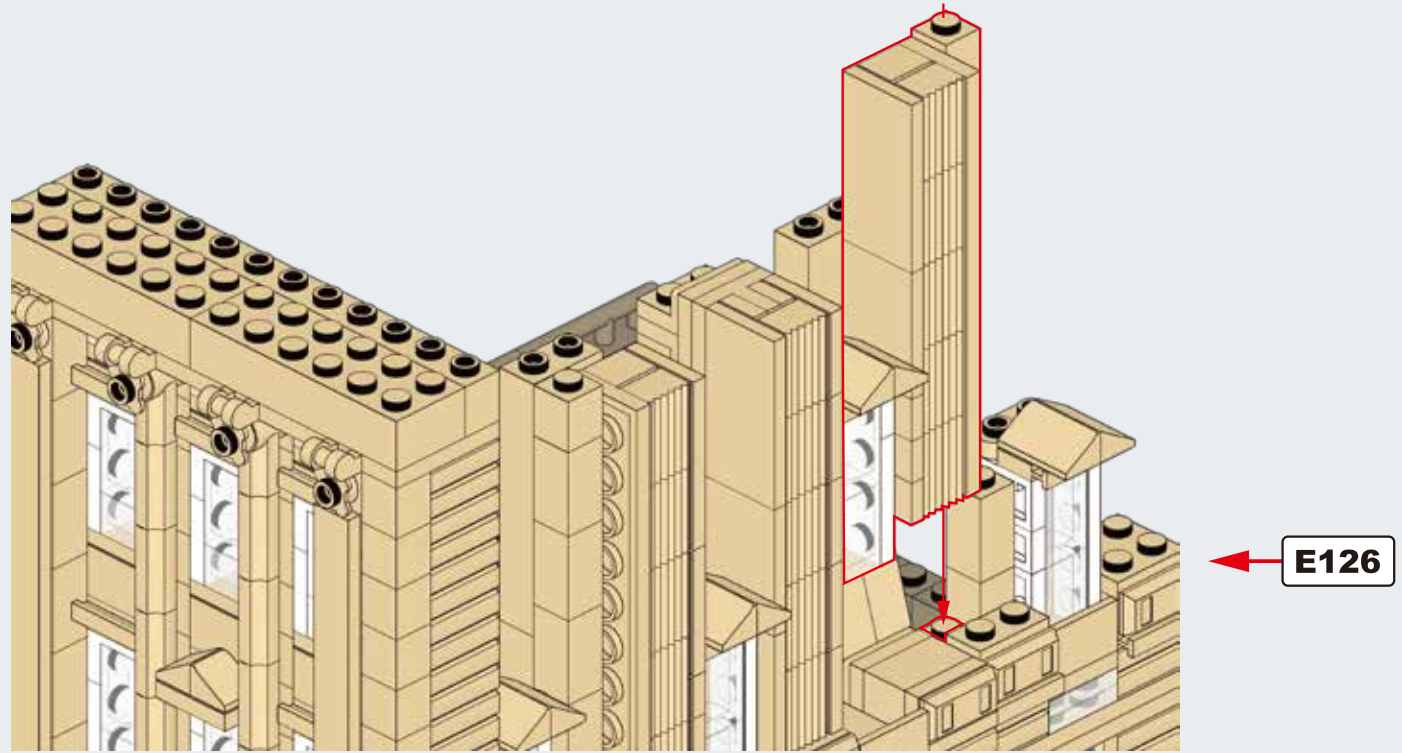

E135

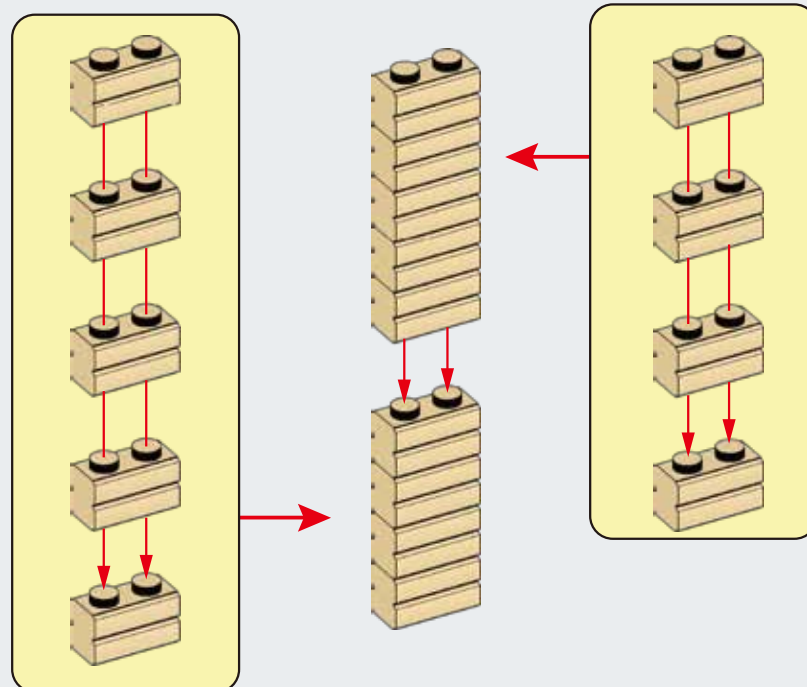

x3

E136

E134

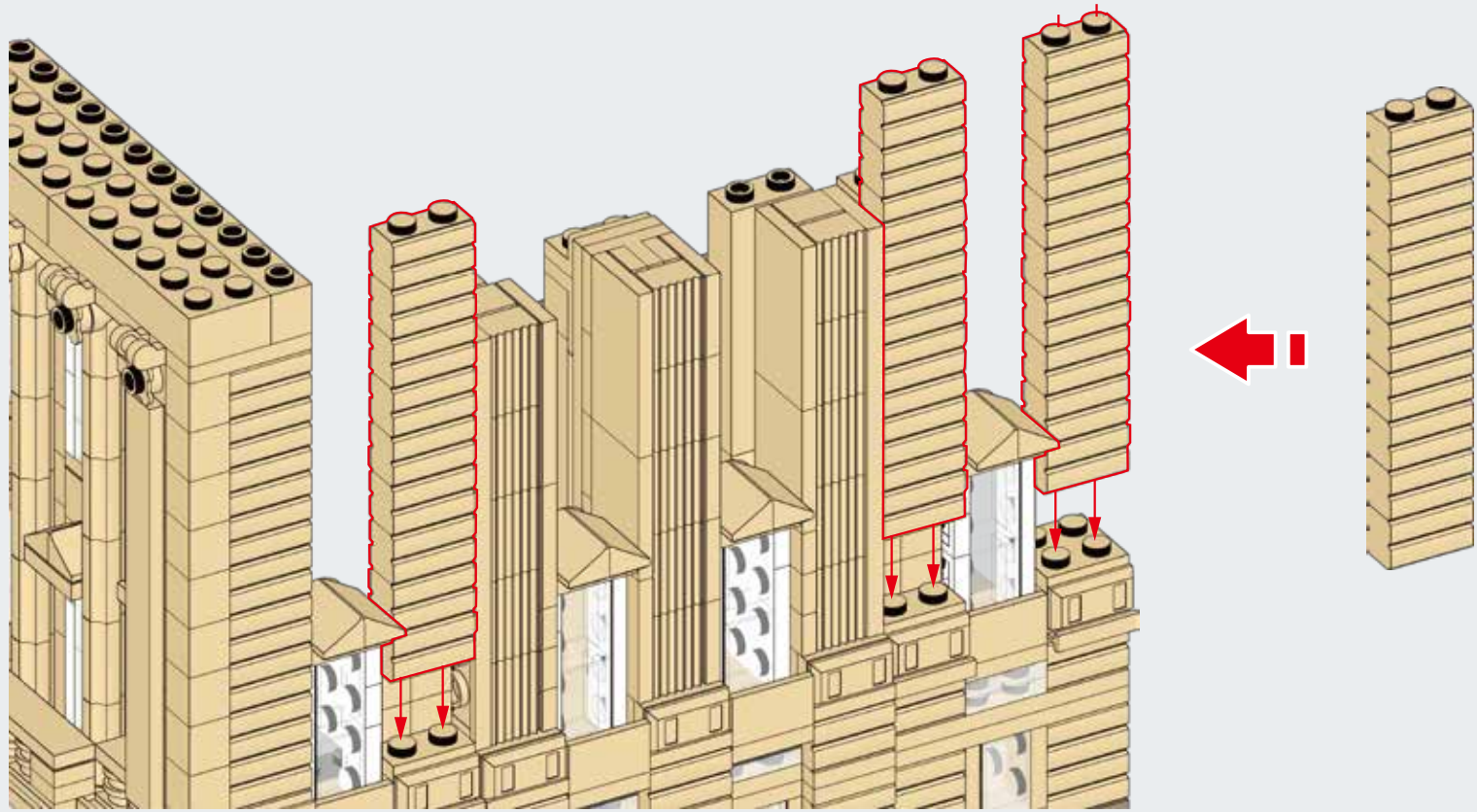

E137

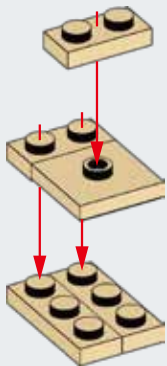

x4



E138

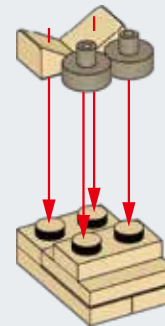

x4

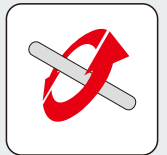

E139



E136

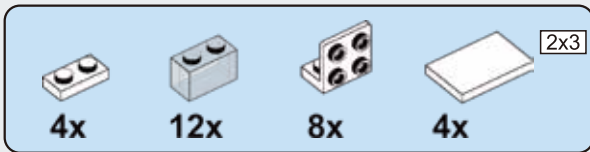
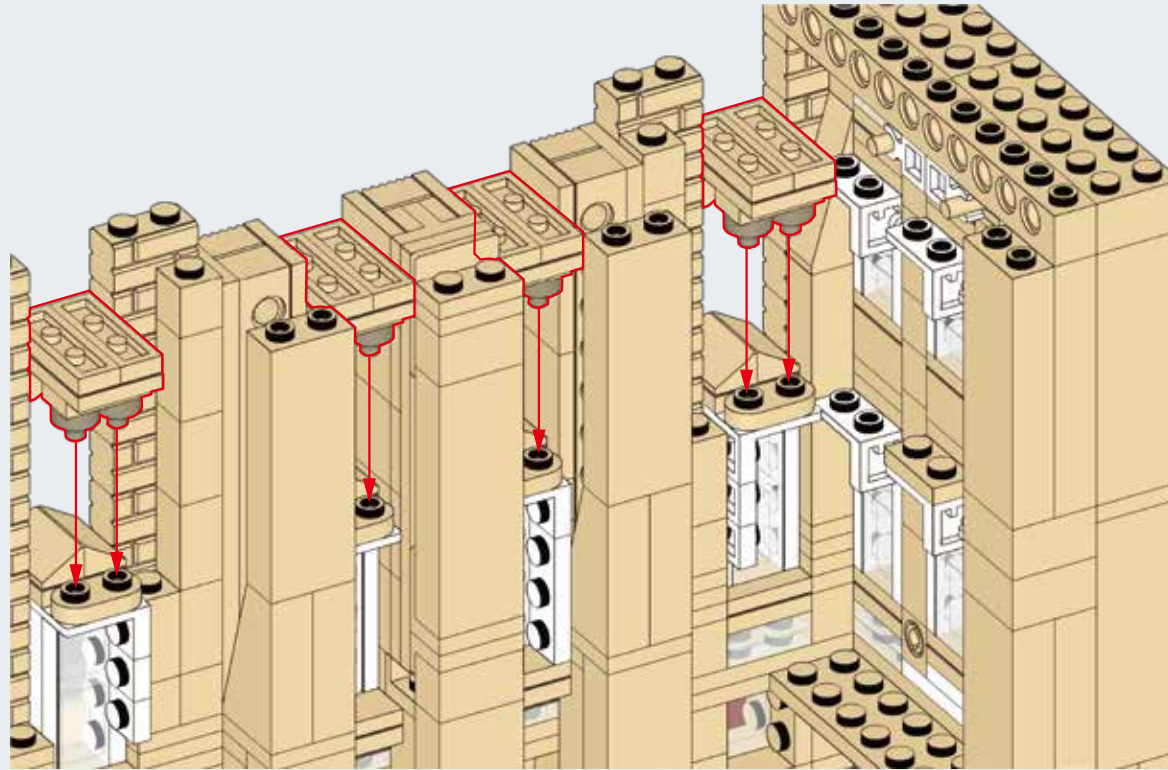

E140

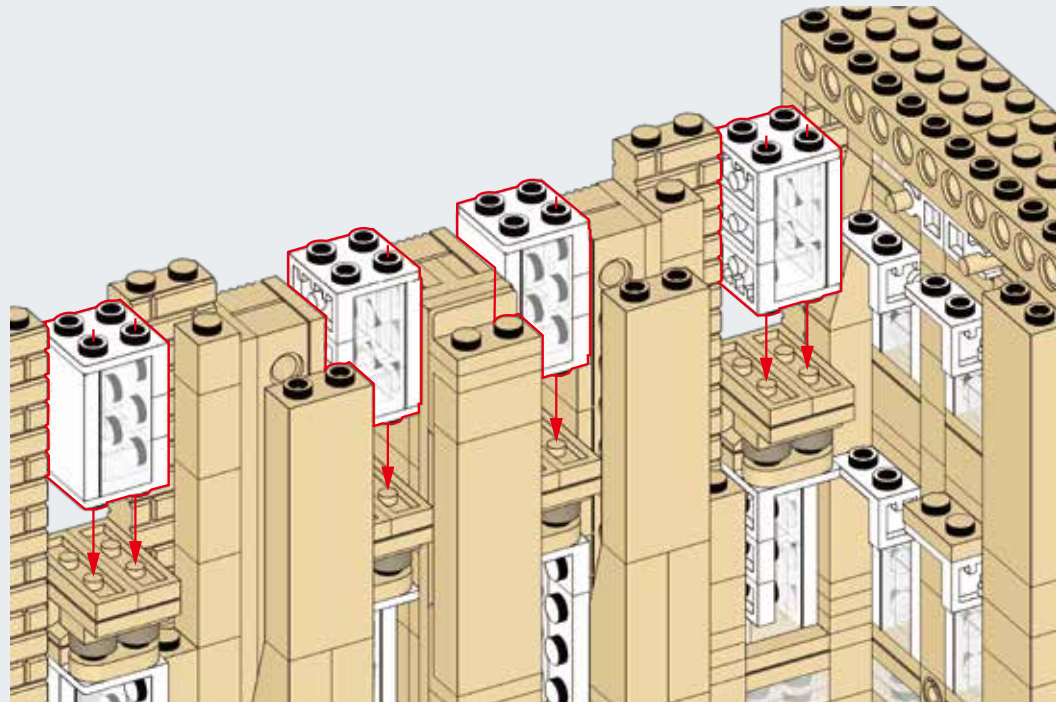
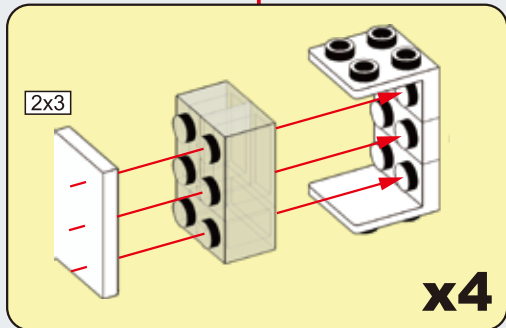



E141

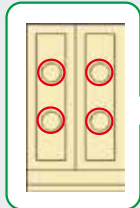

1

2

x4

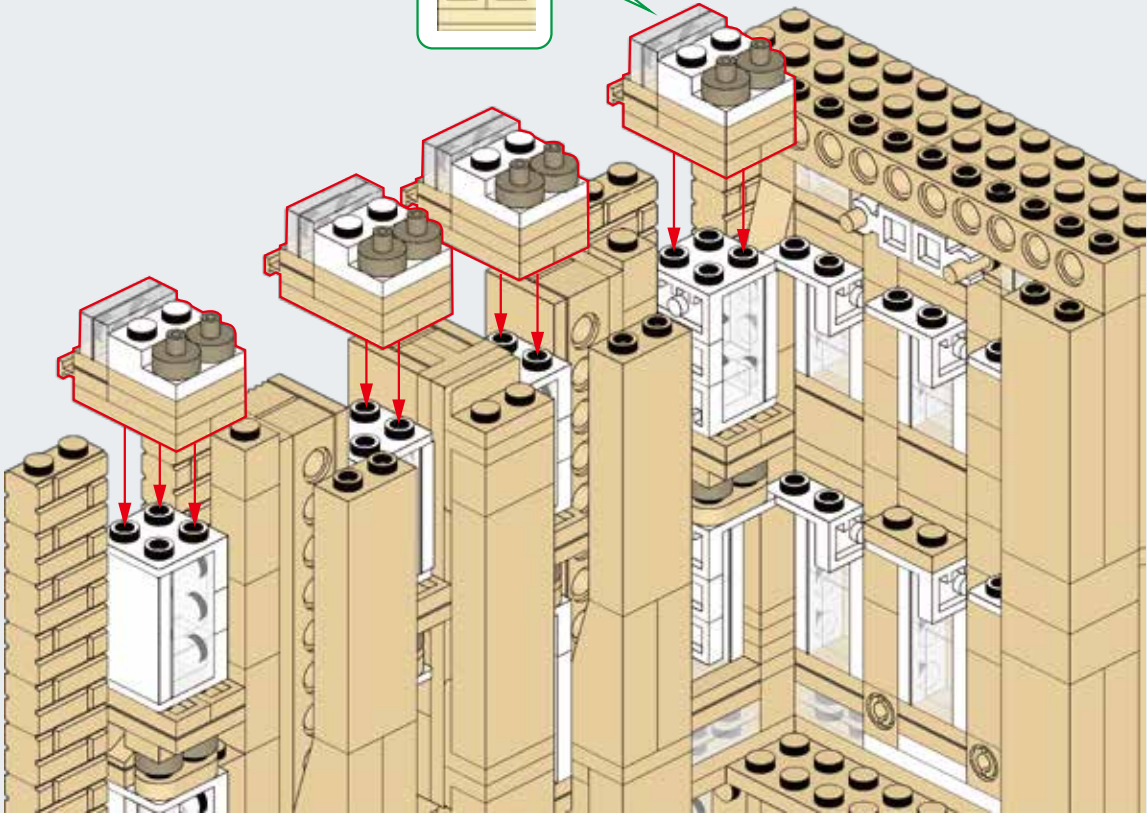

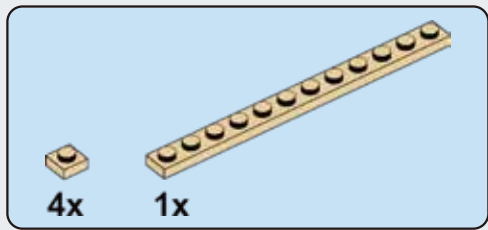

E142

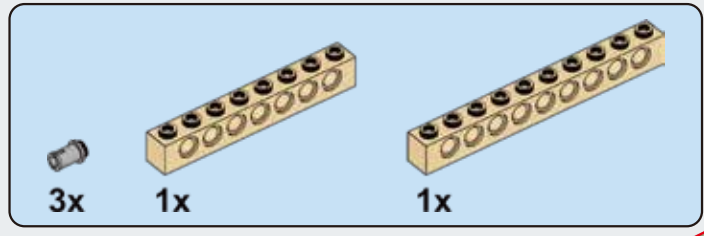
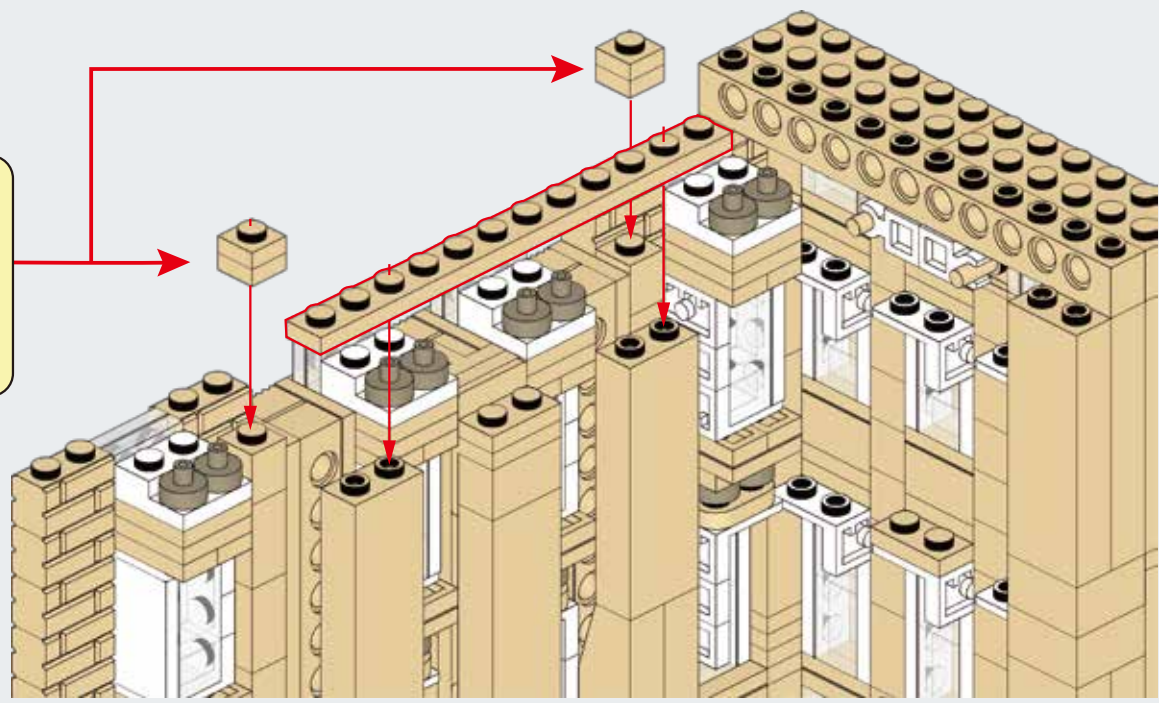
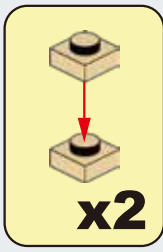

E143

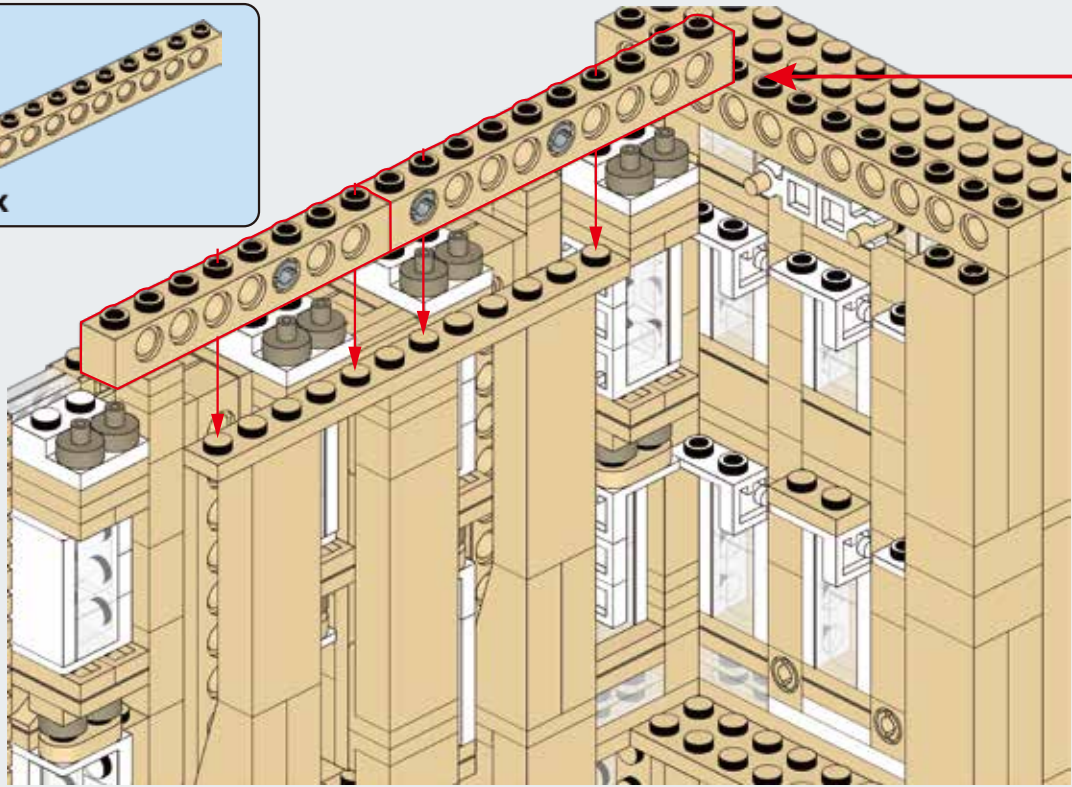
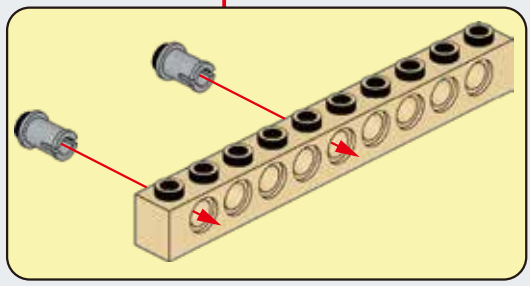
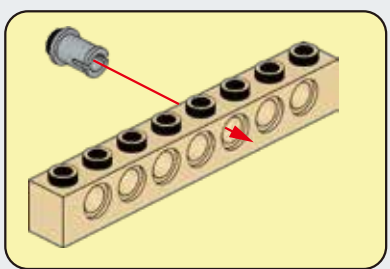



E144

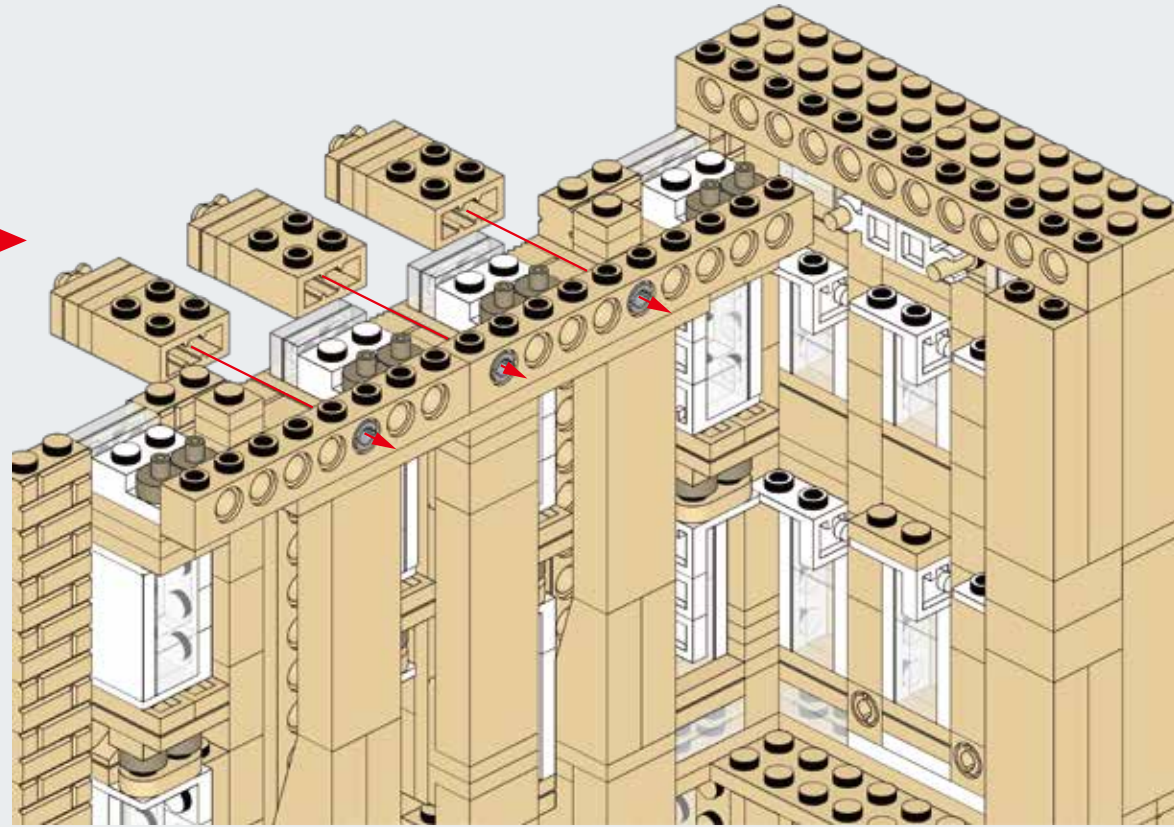
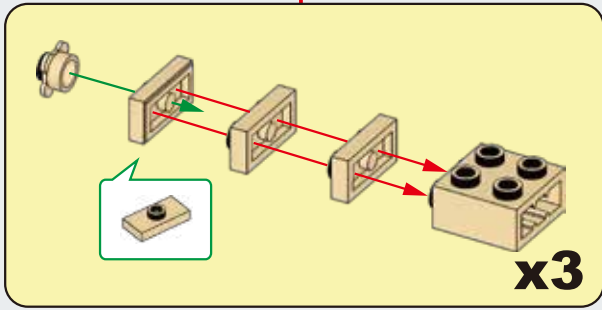

E145

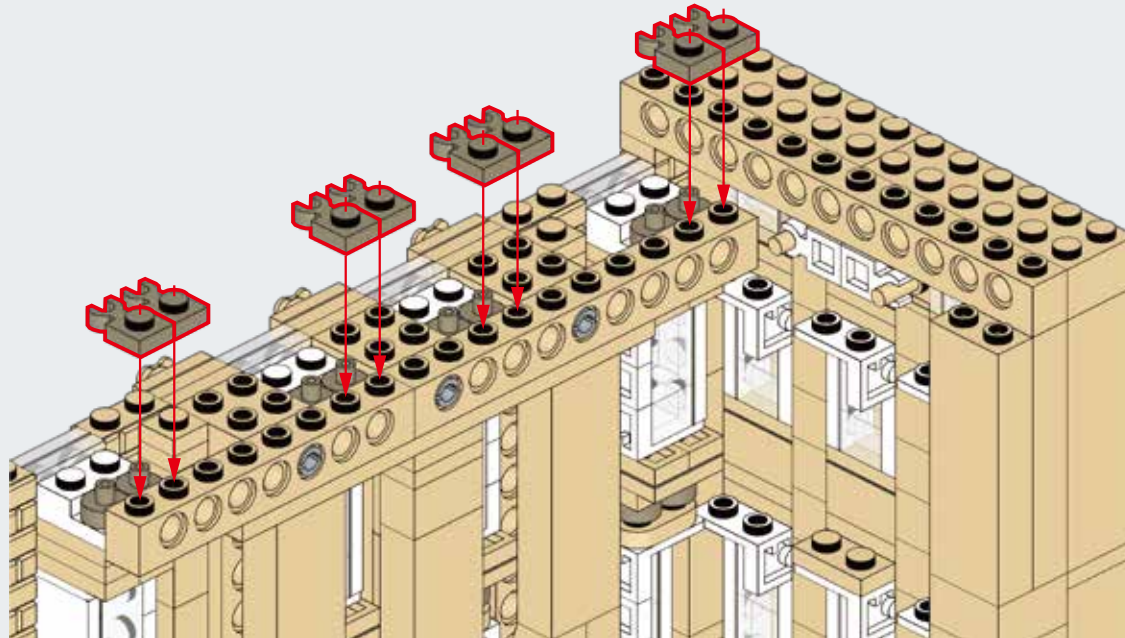



E146

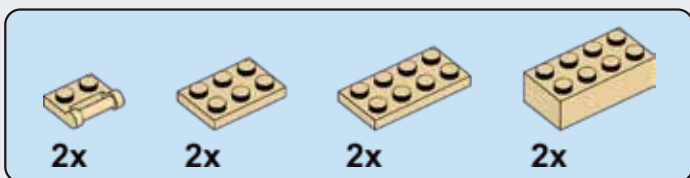
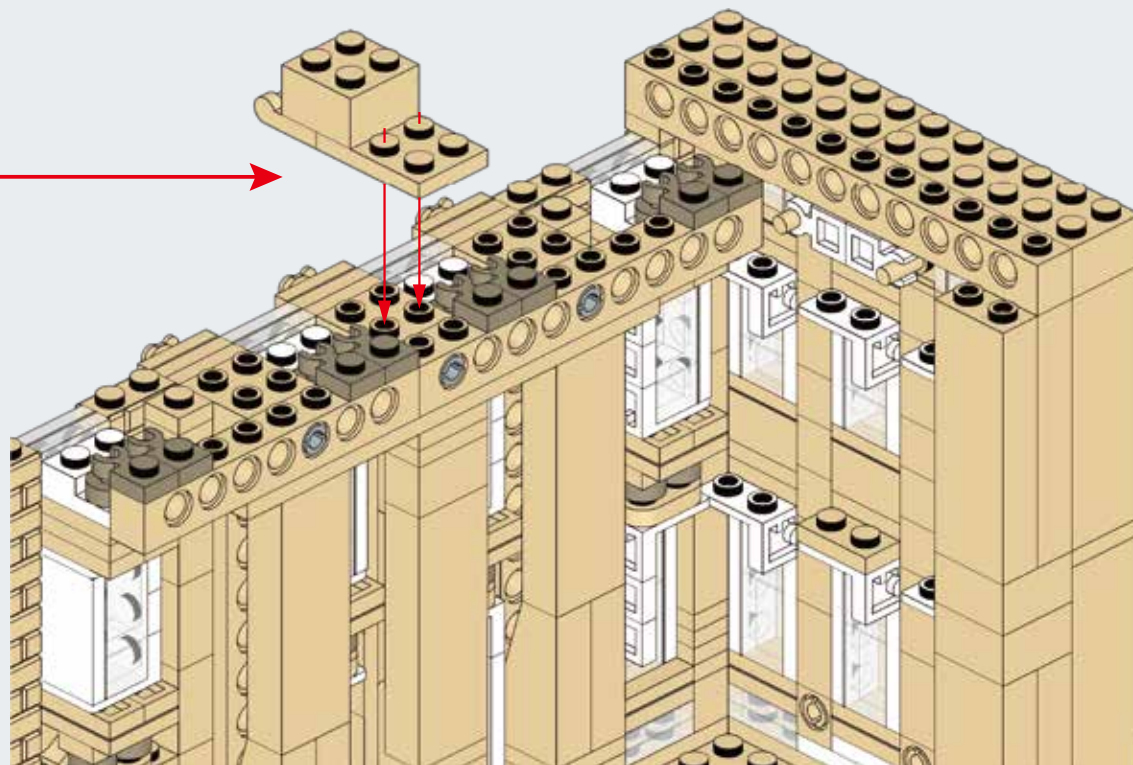
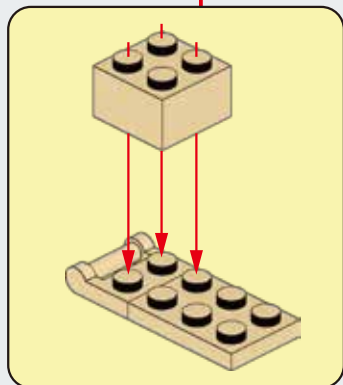

E147

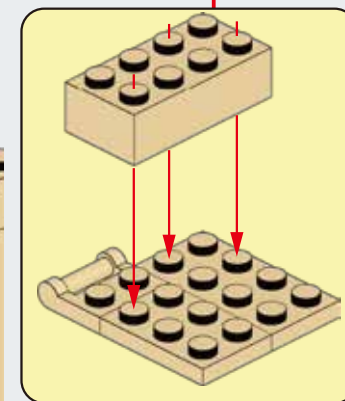
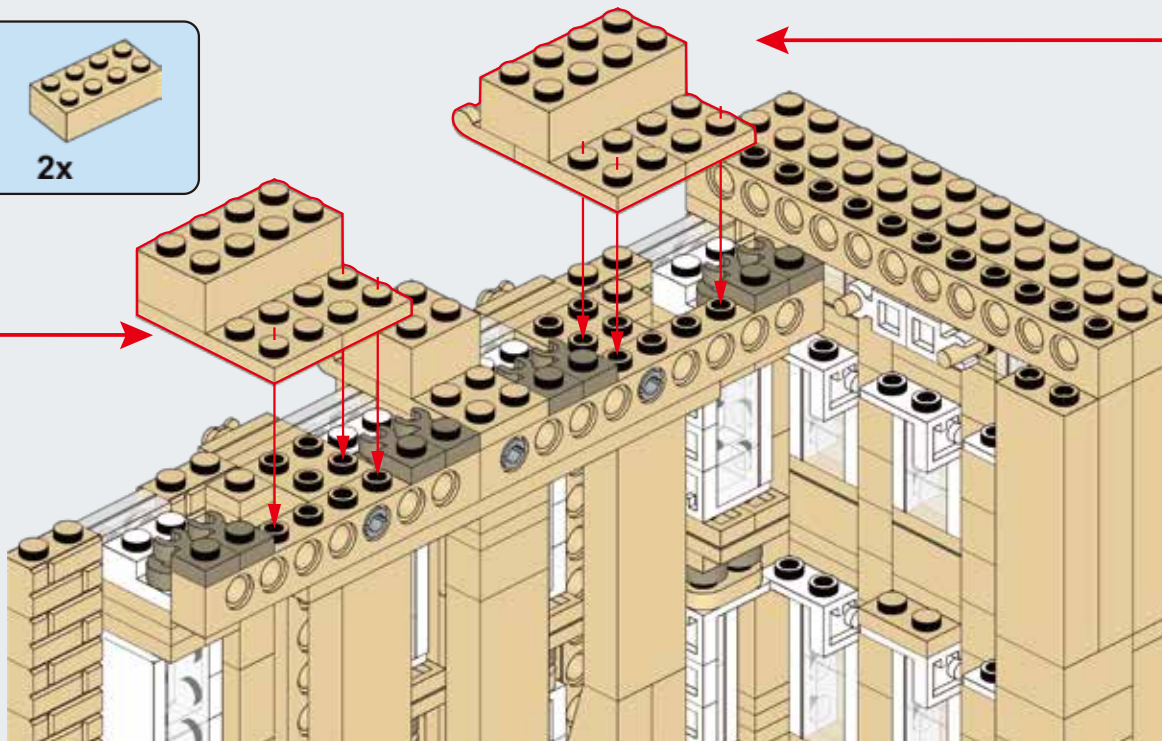
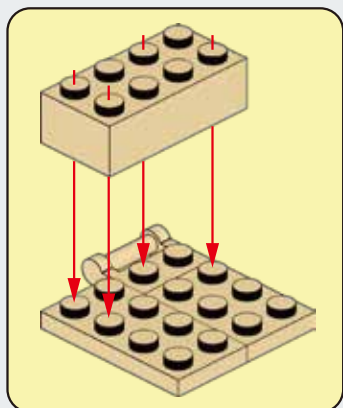

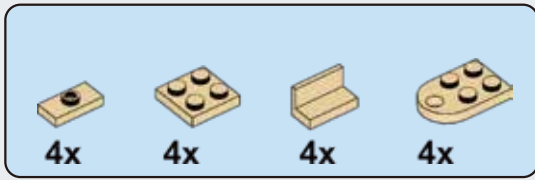

E148

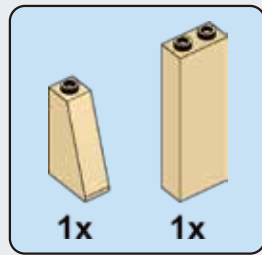
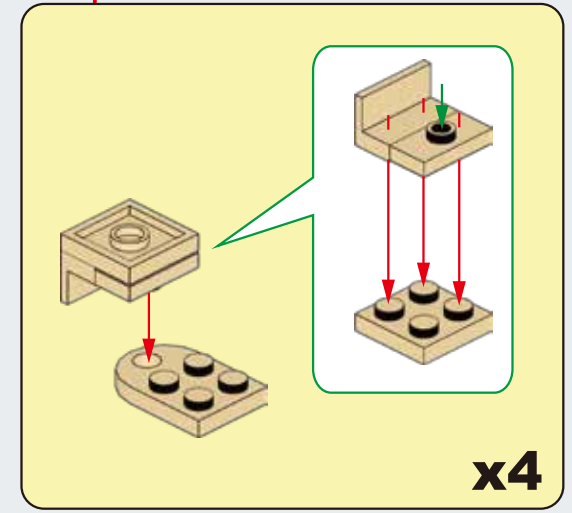
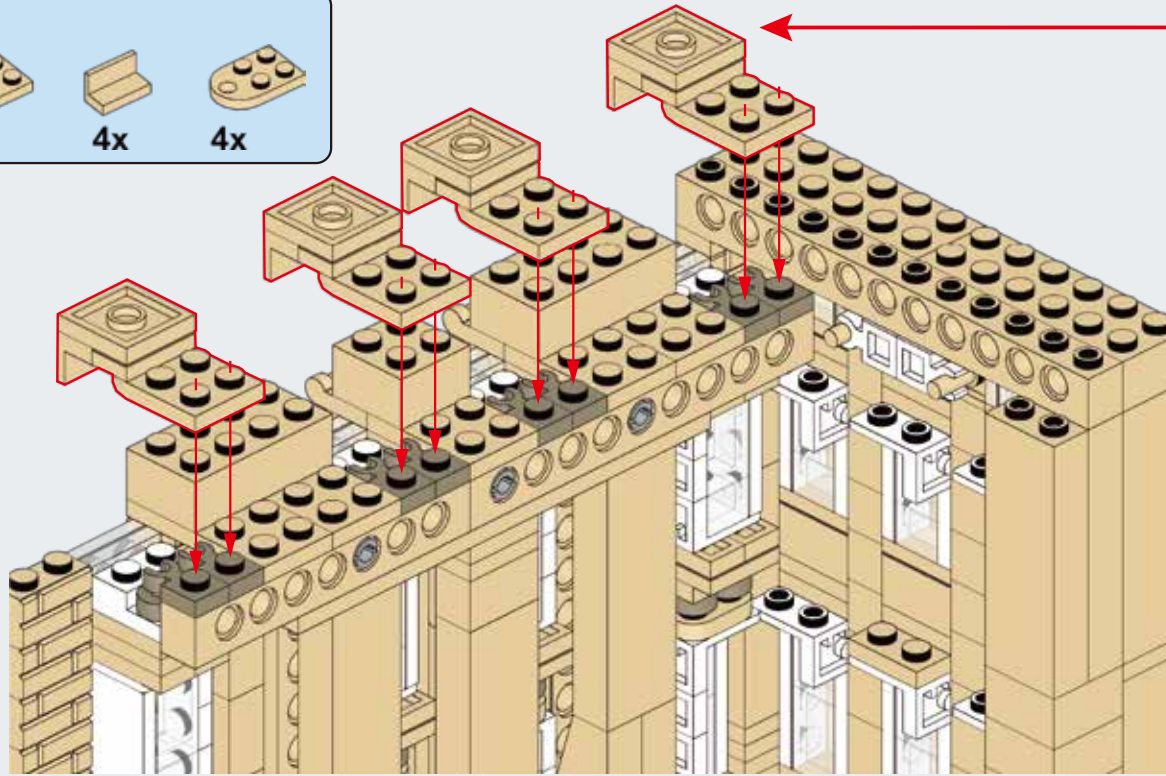

E149

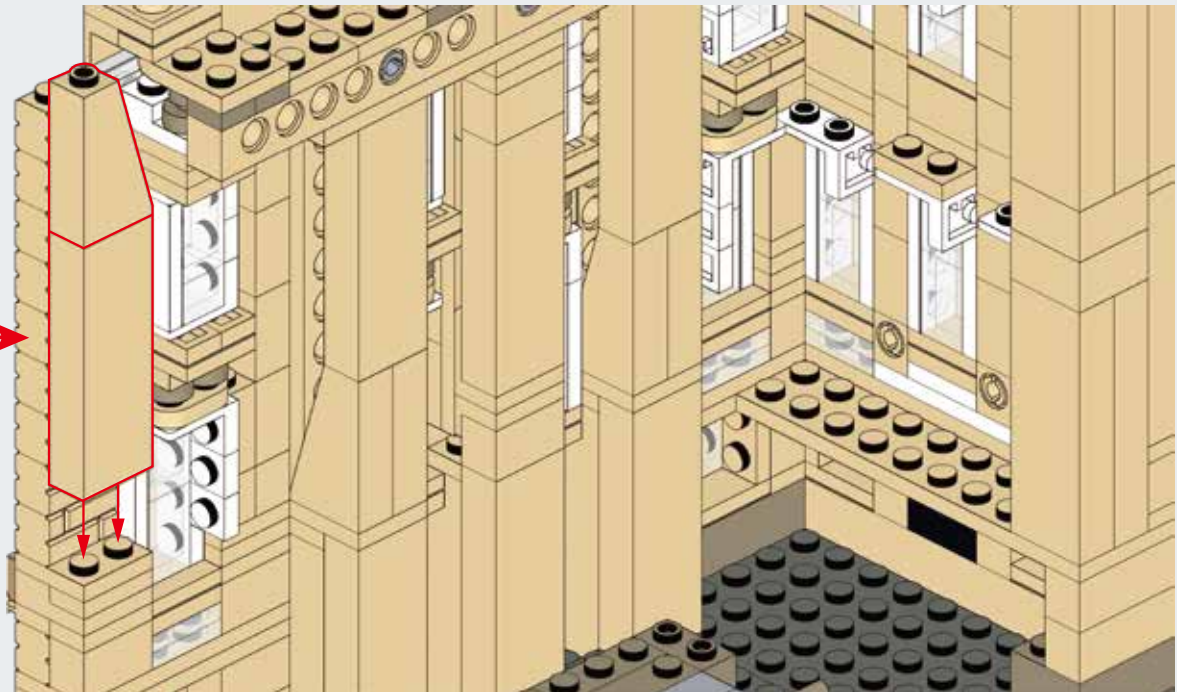
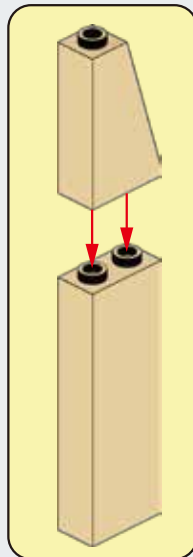

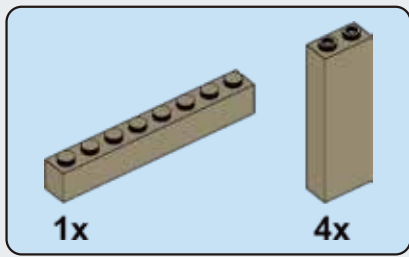

E150

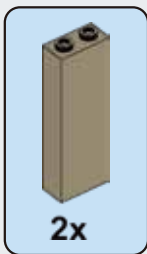
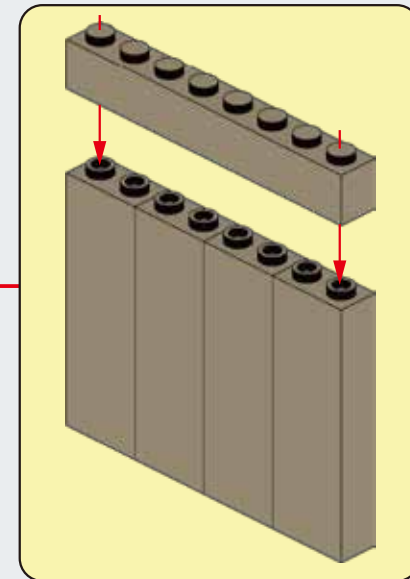
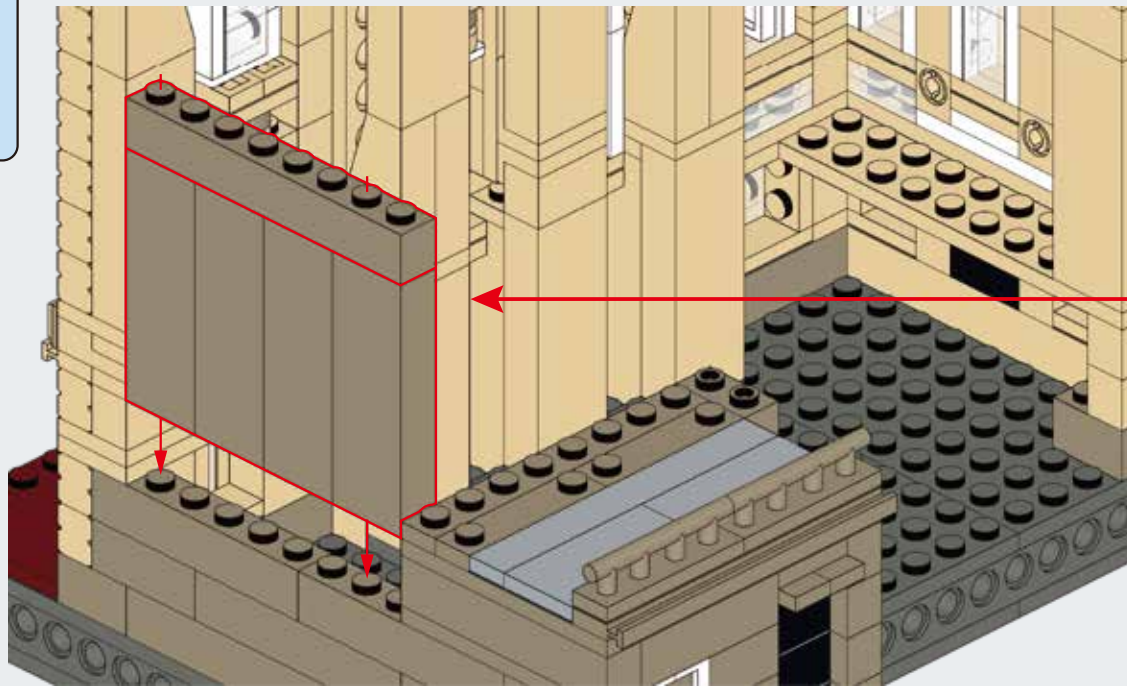

E151

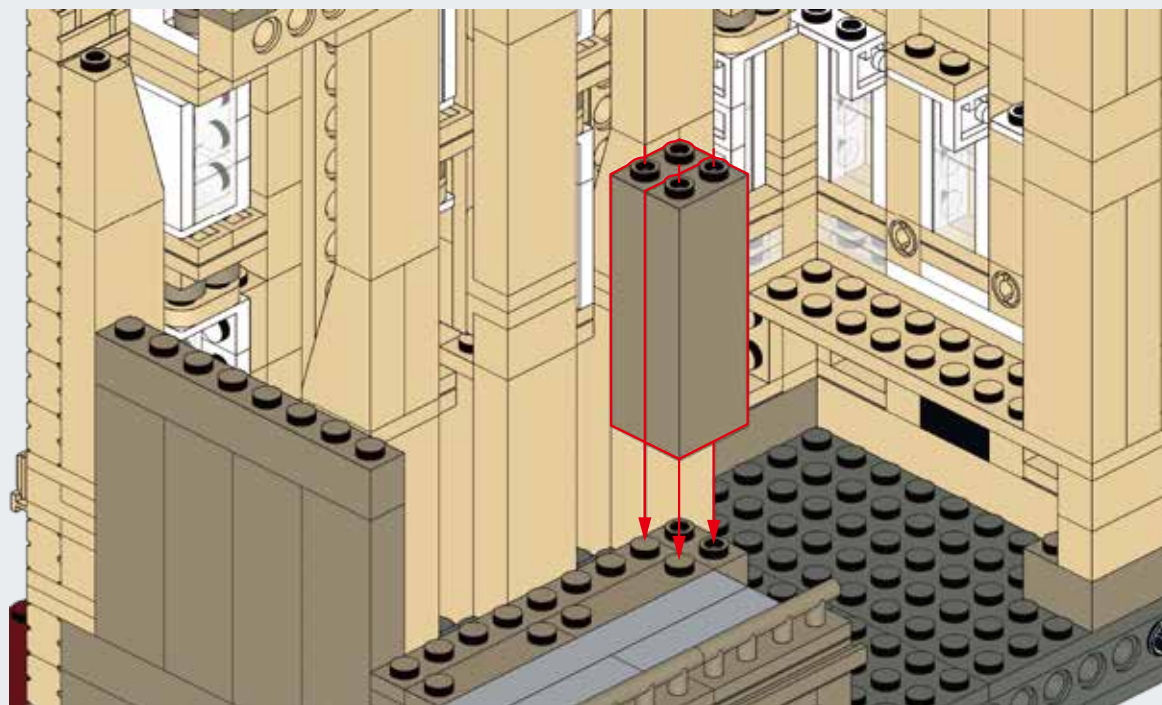

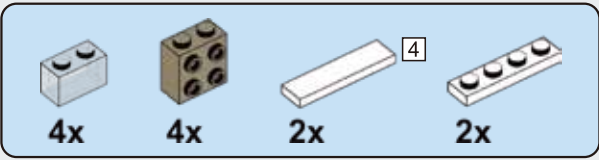

E152

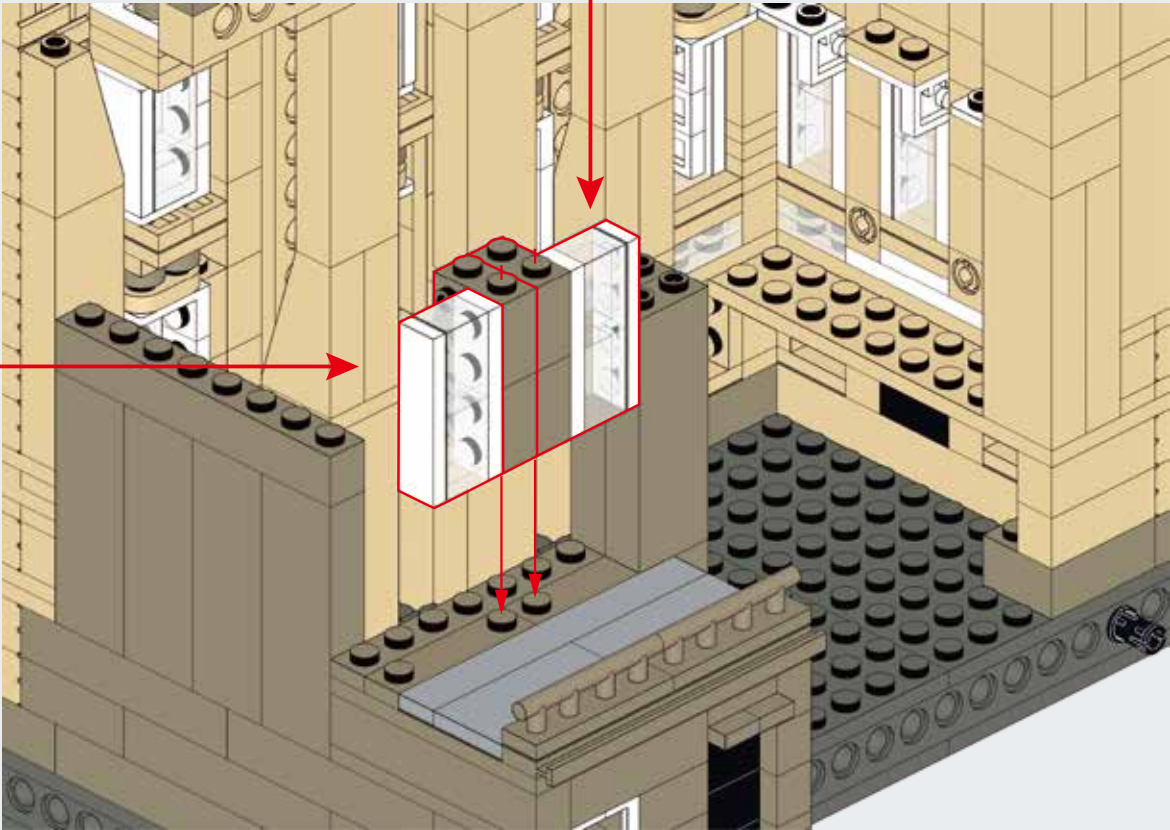
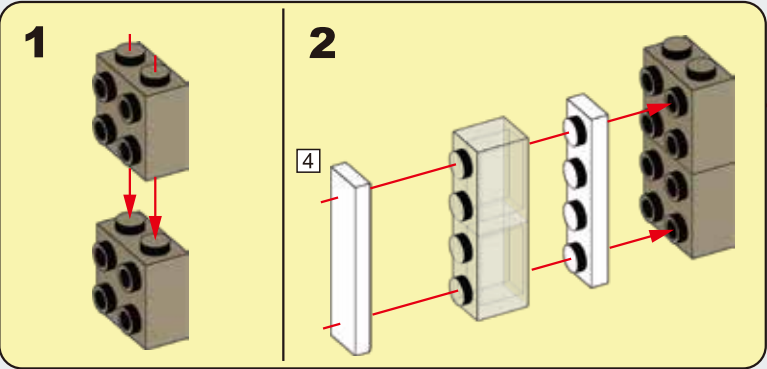
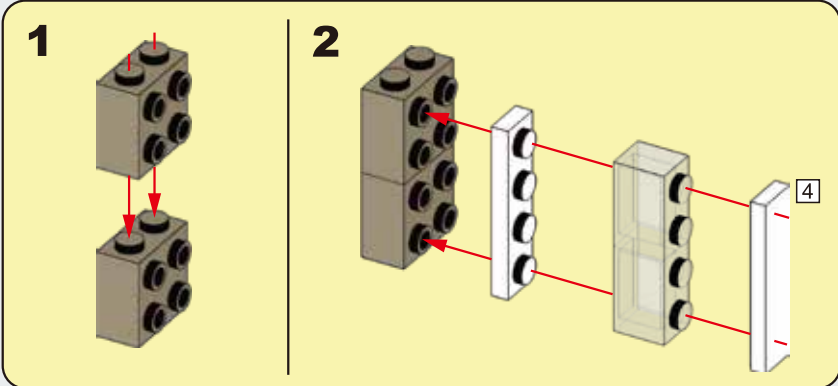

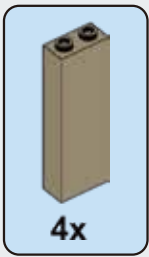

E153

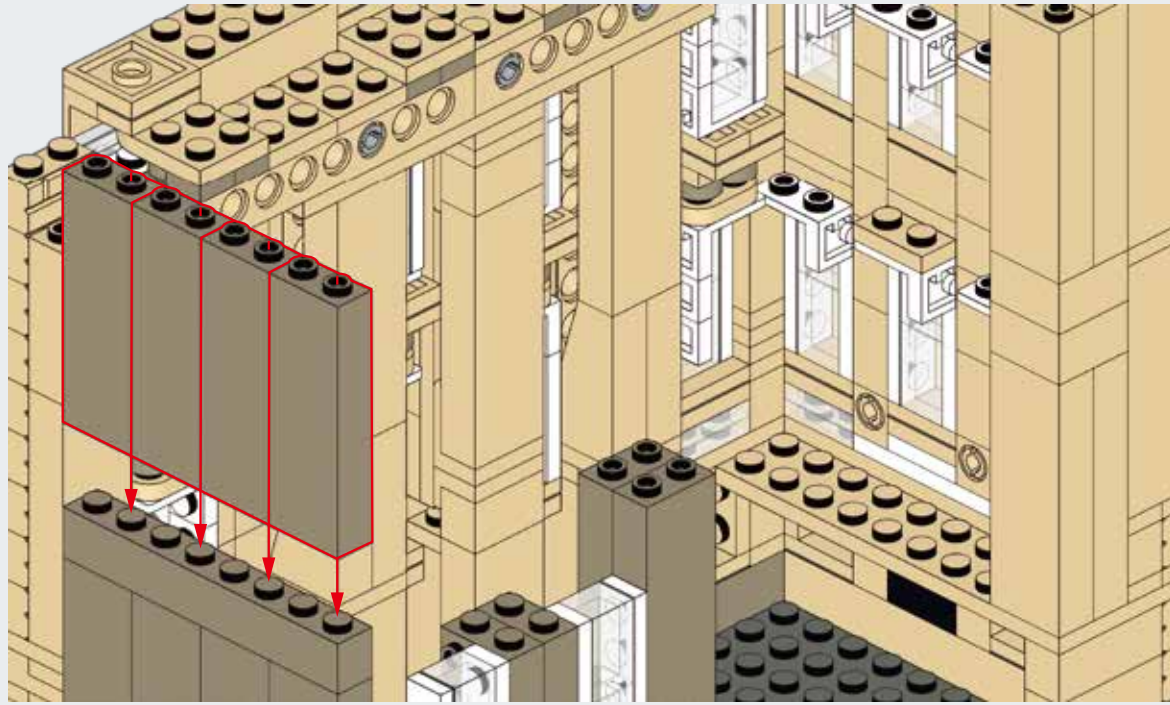

E154

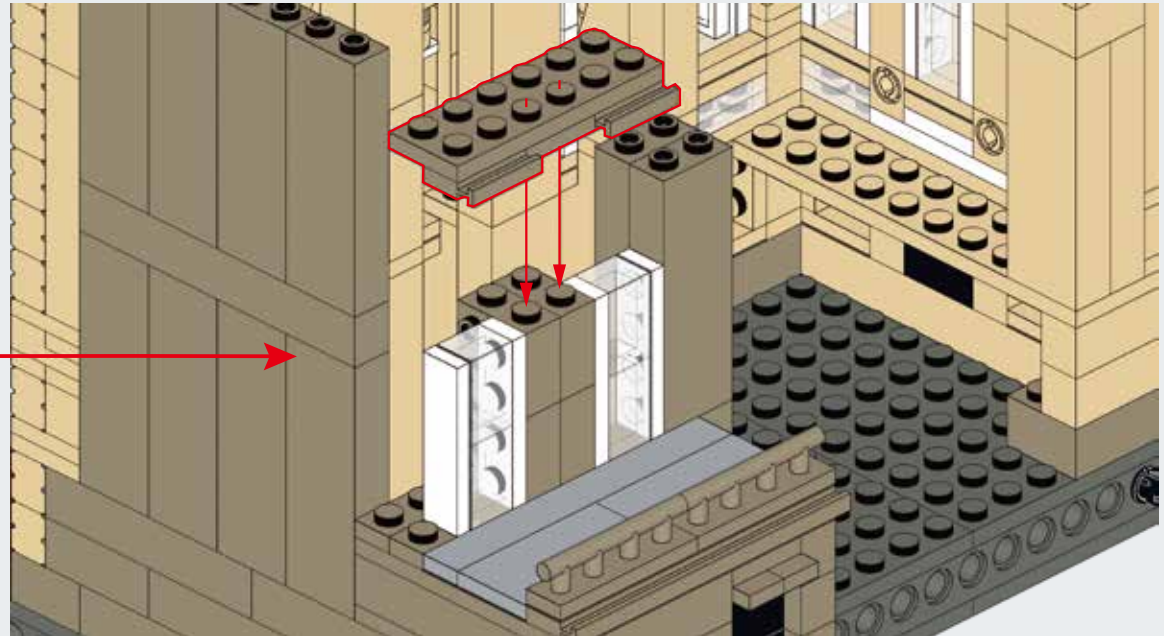
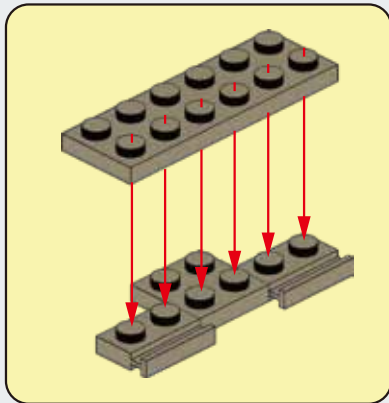

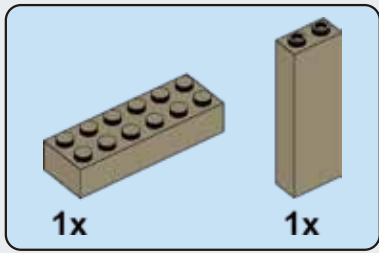

E155

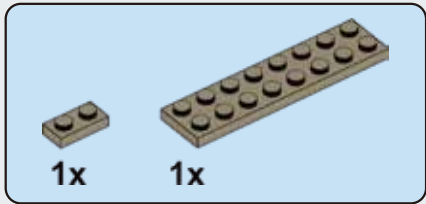
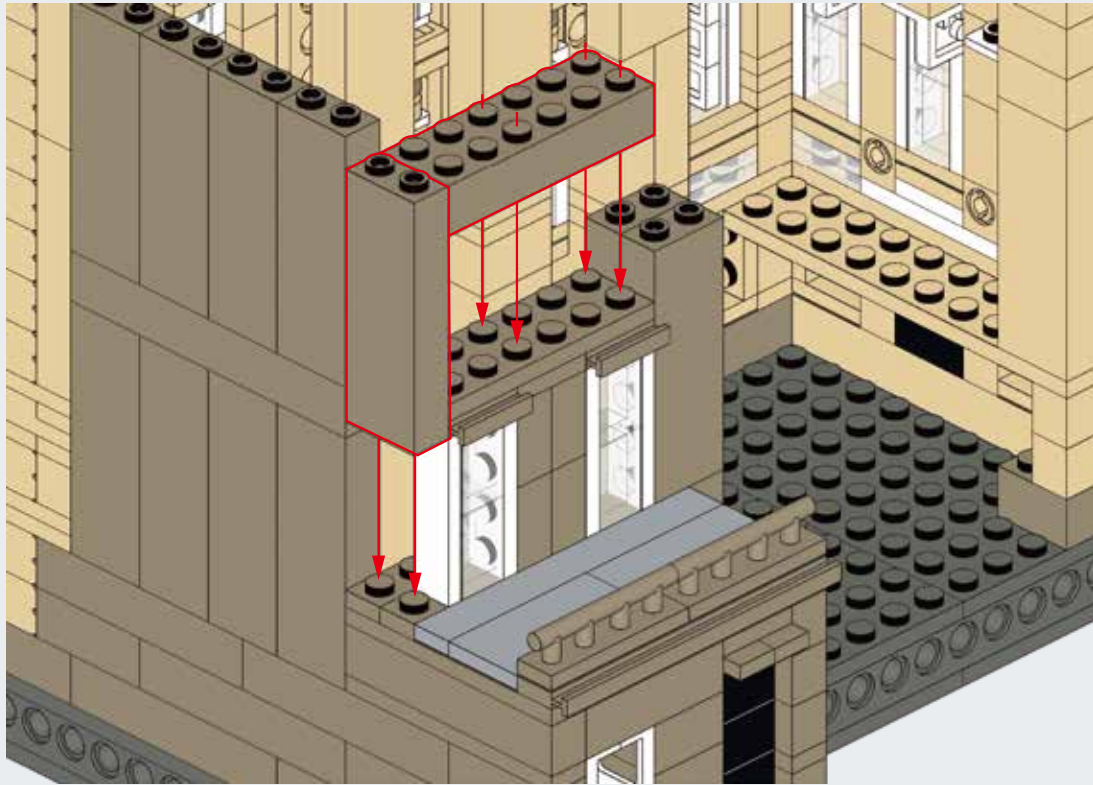

E156

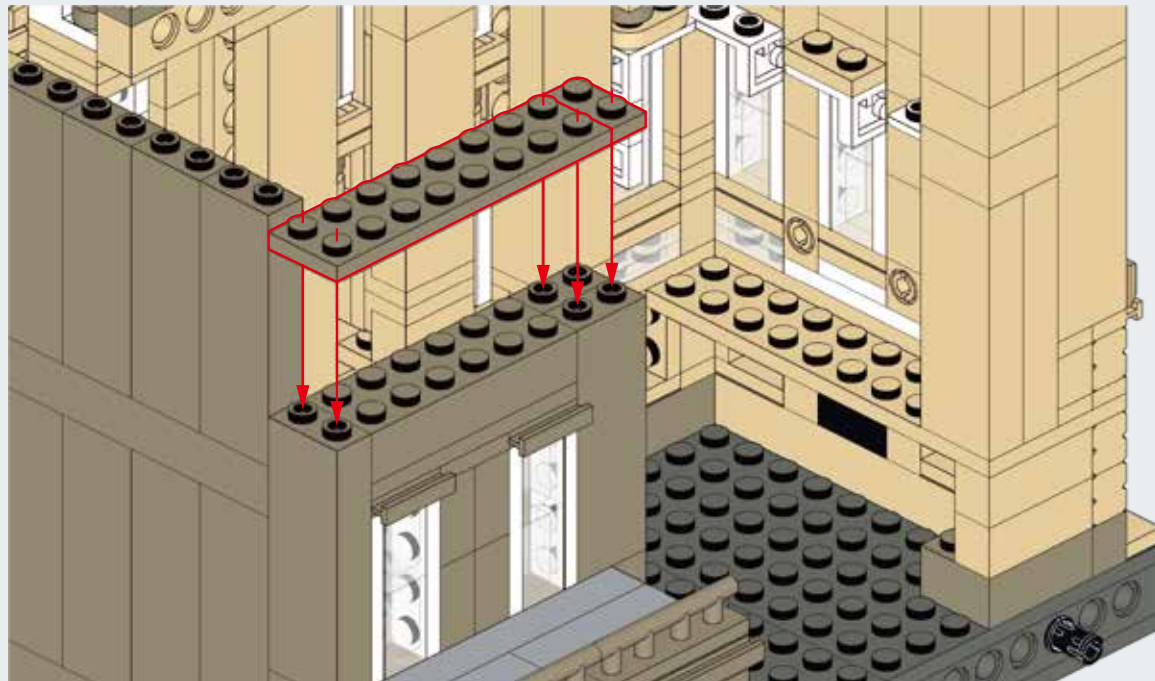

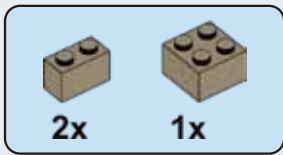

E157

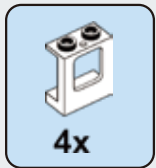
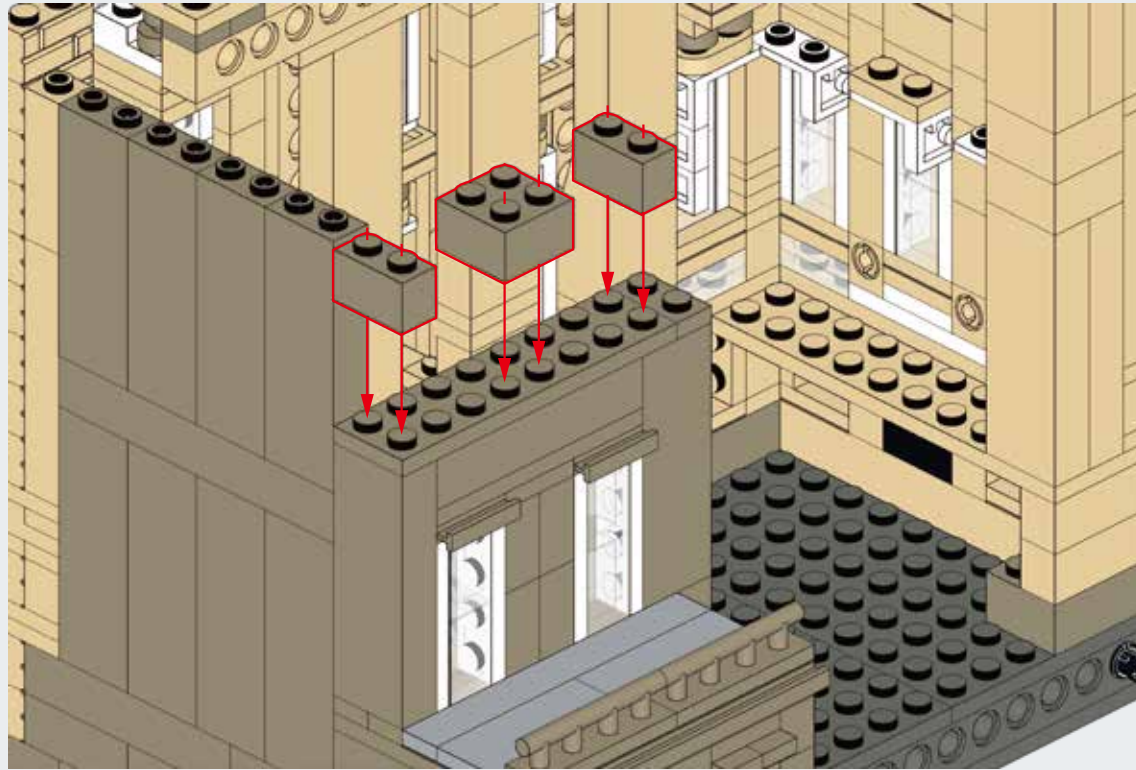

E158

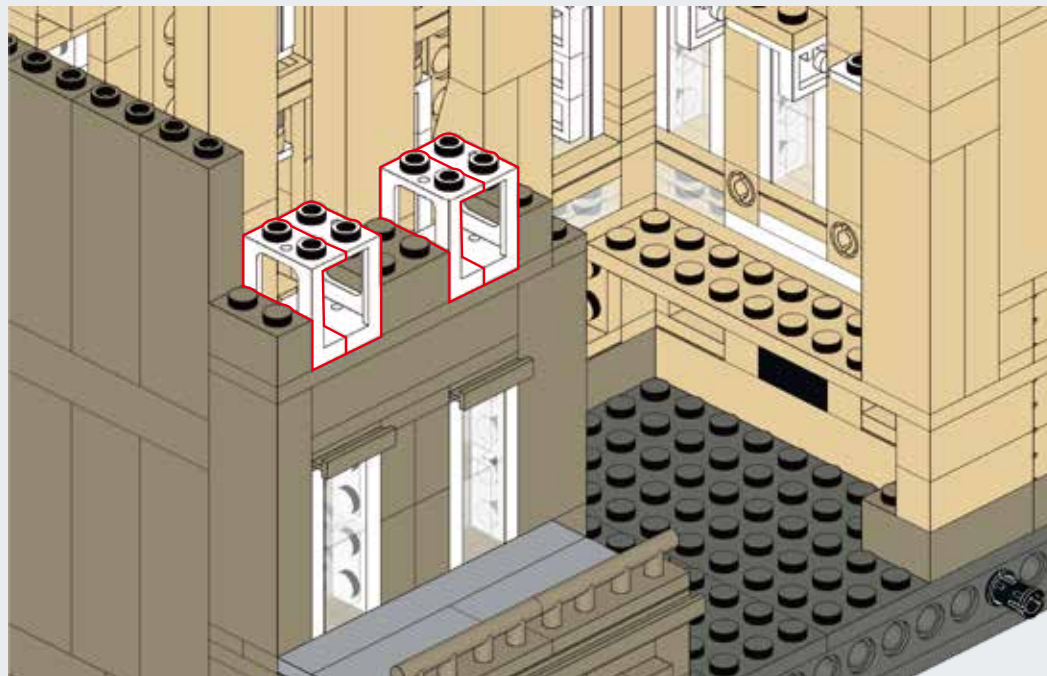

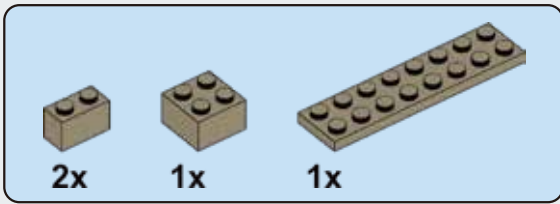

E159

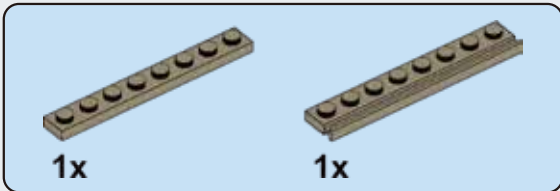
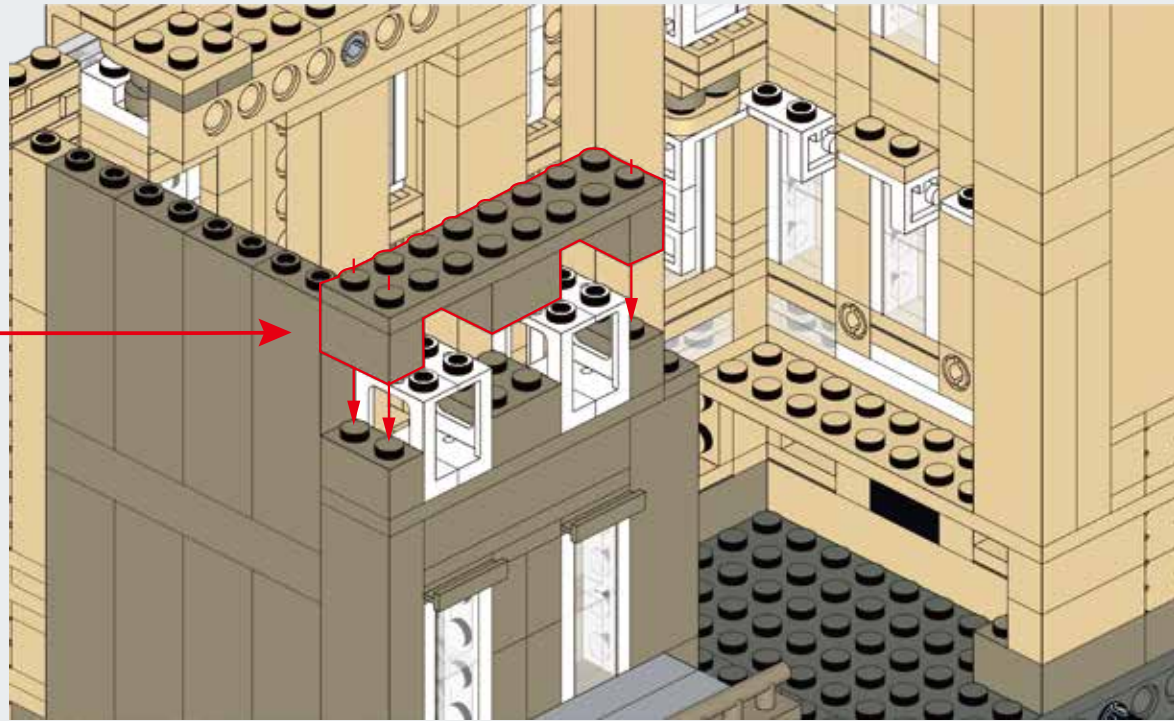
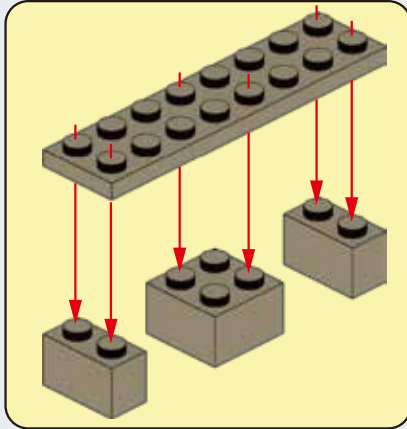

E160

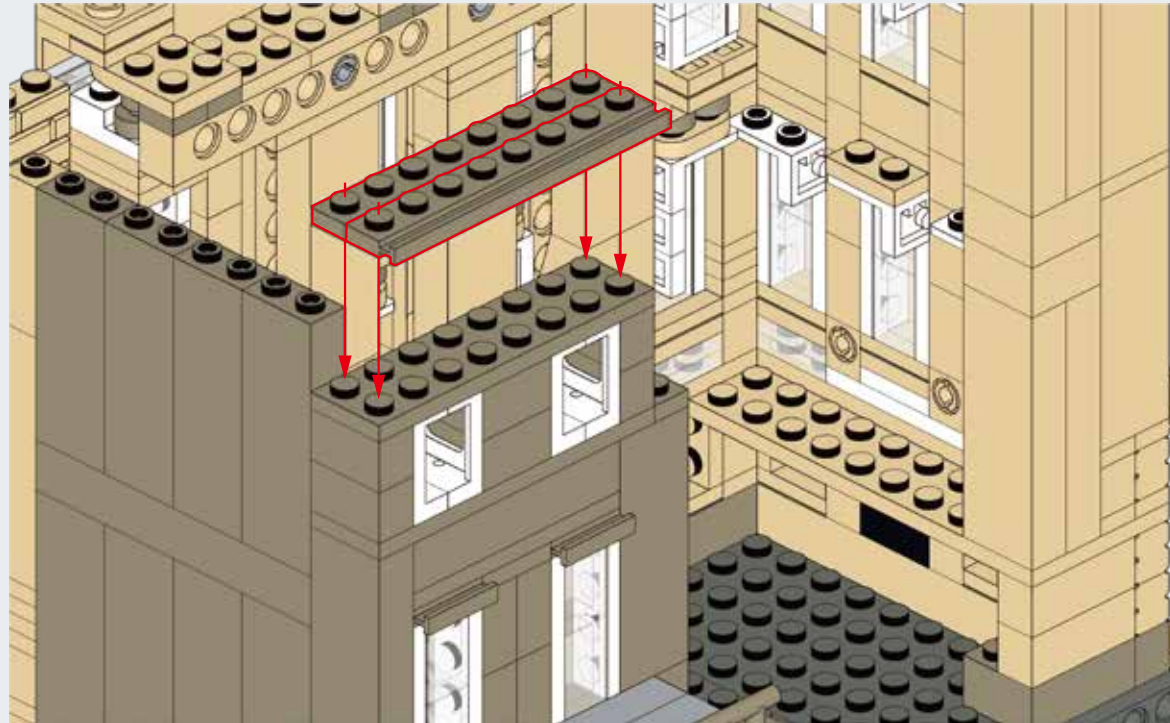

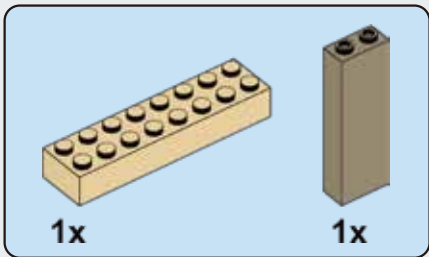

E161

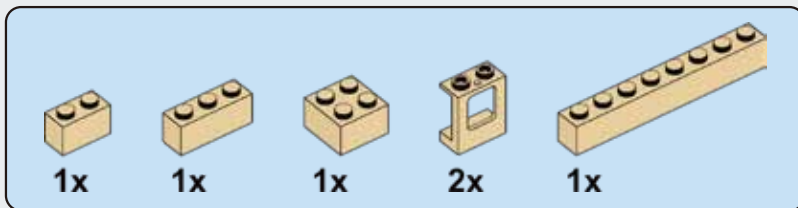
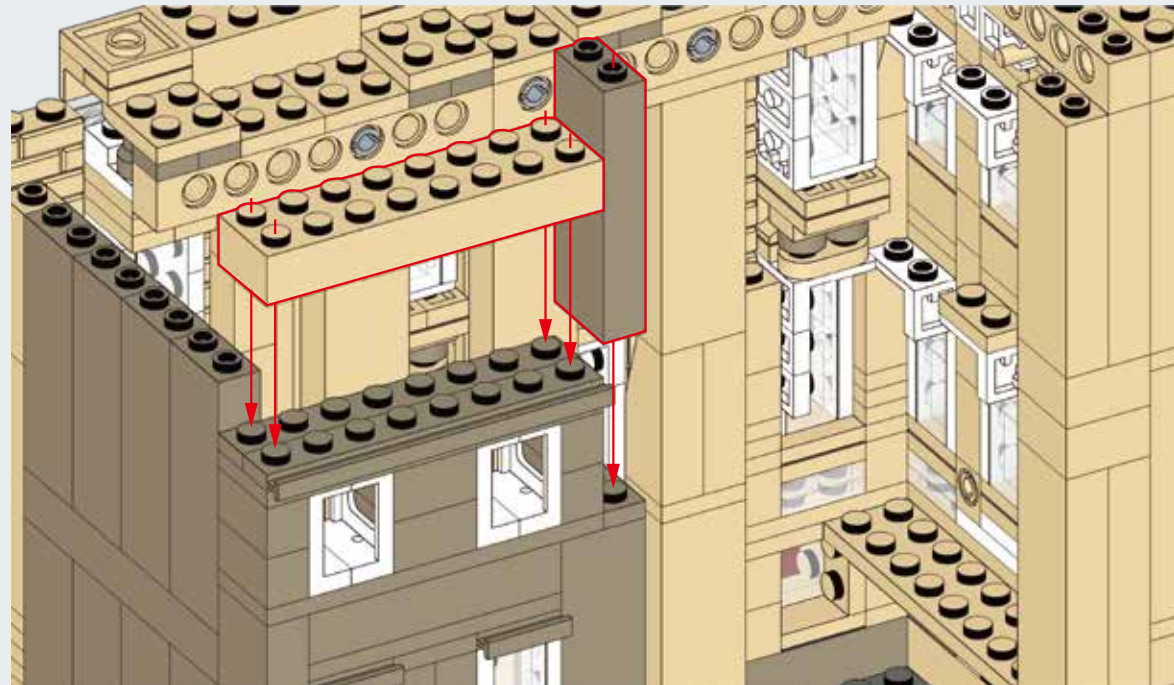

E162

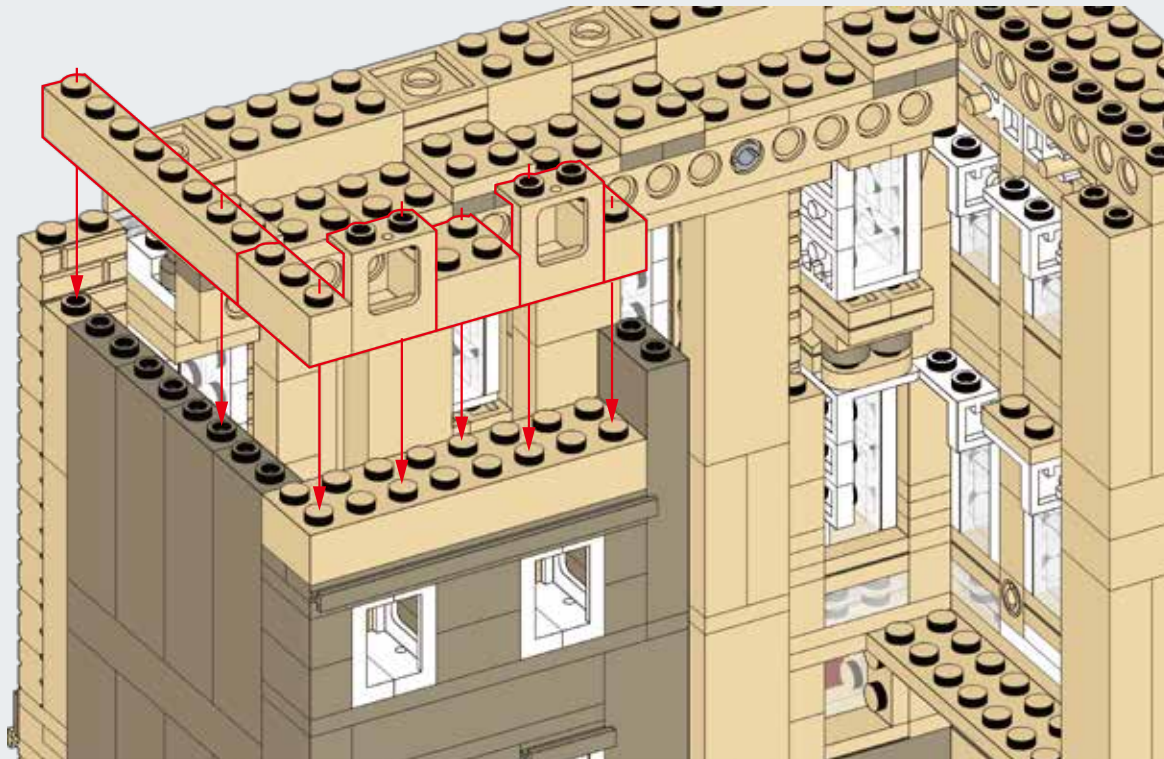

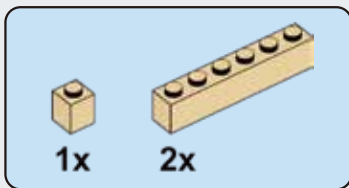

E163

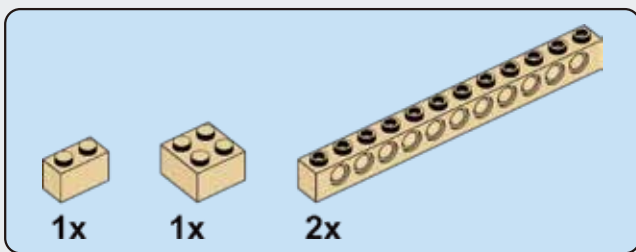
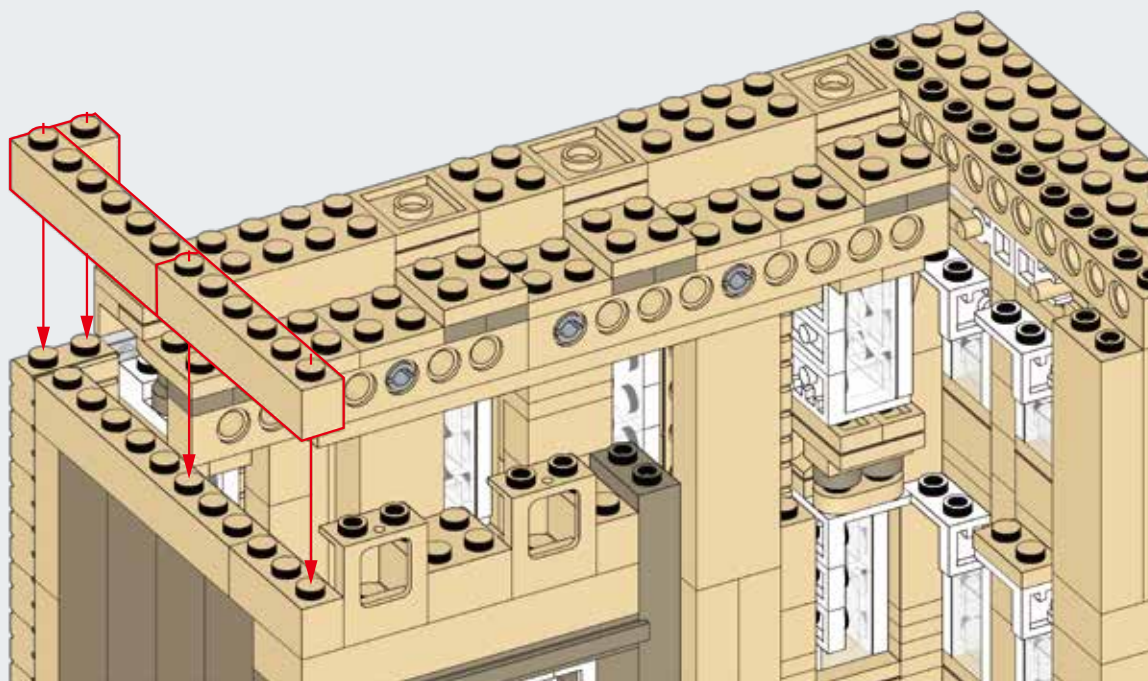

E164

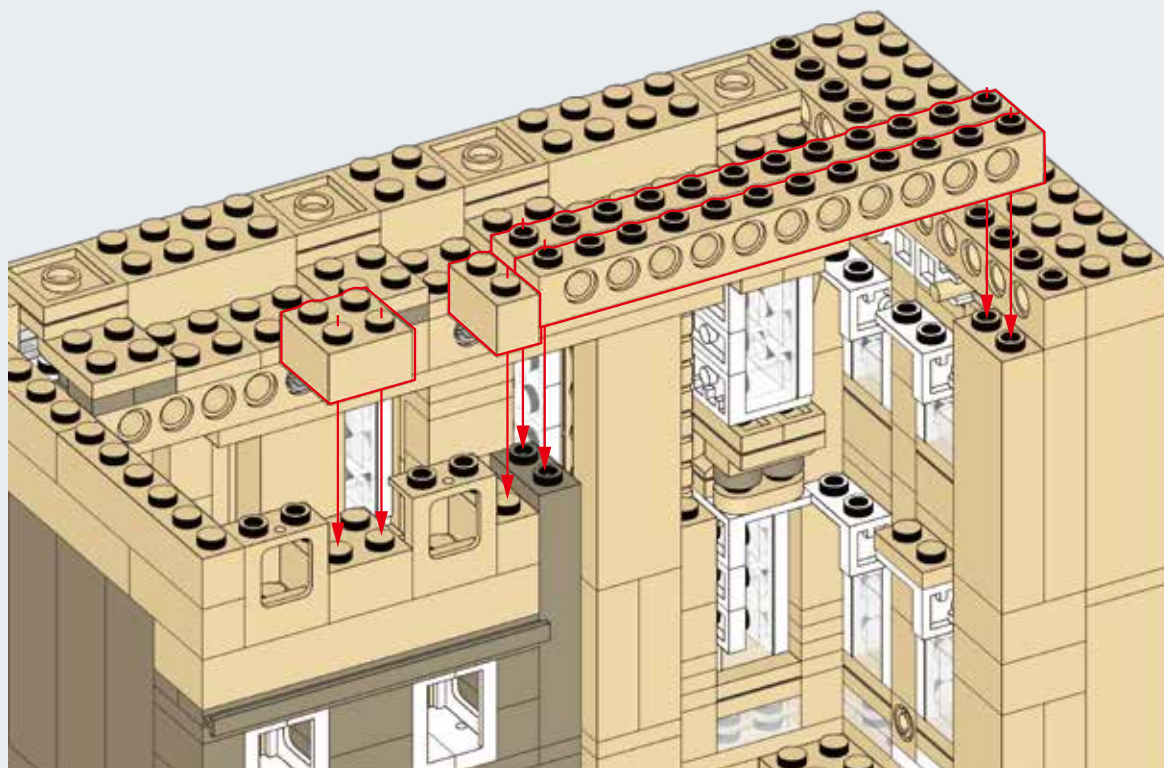

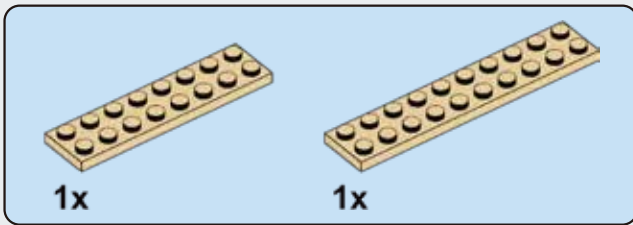

E165

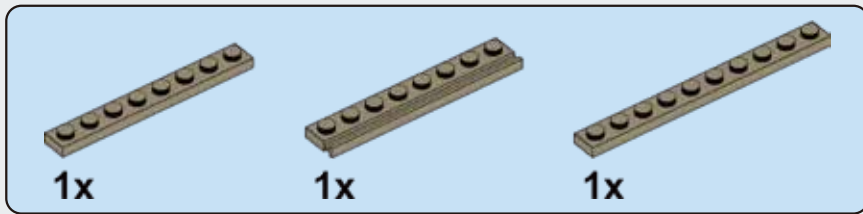
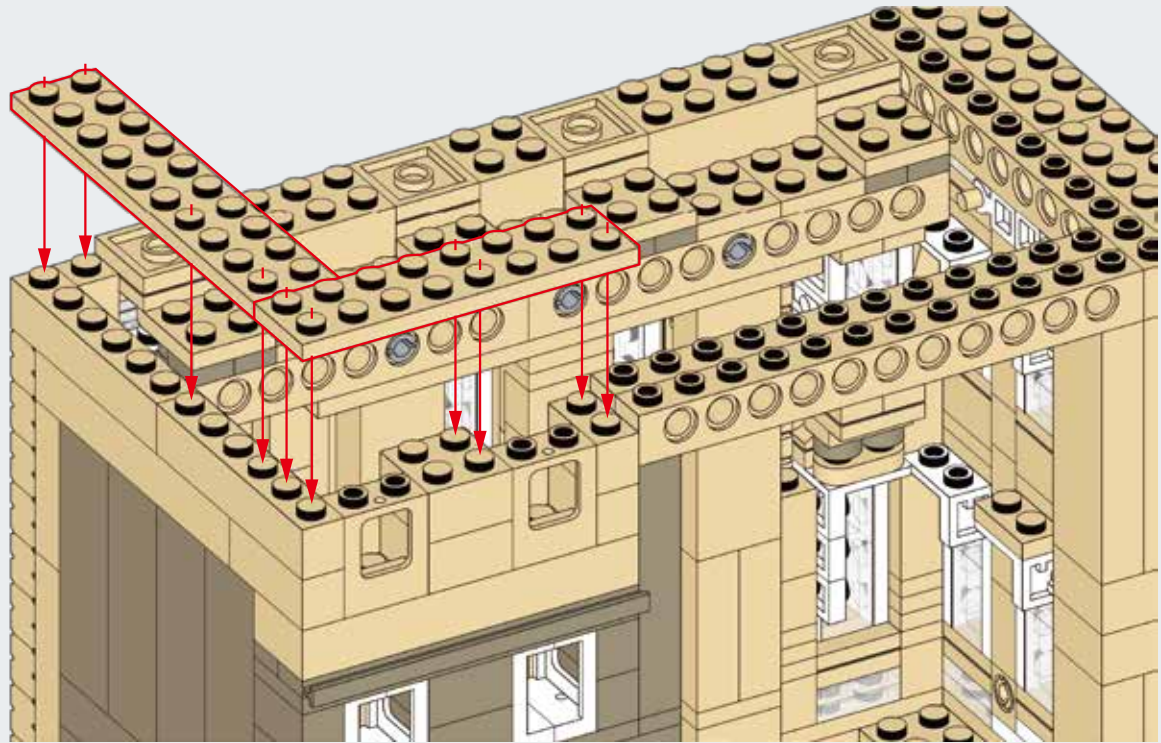

E166

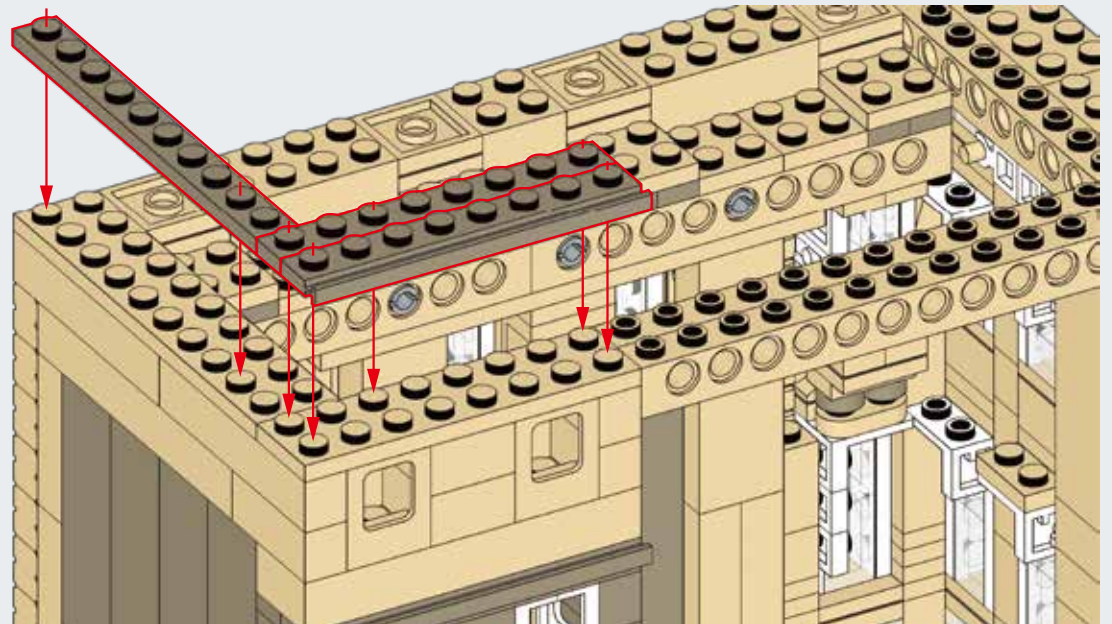

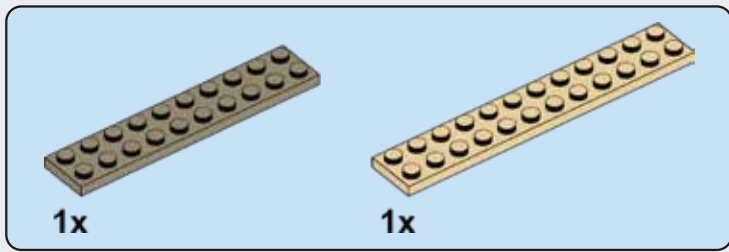

E167

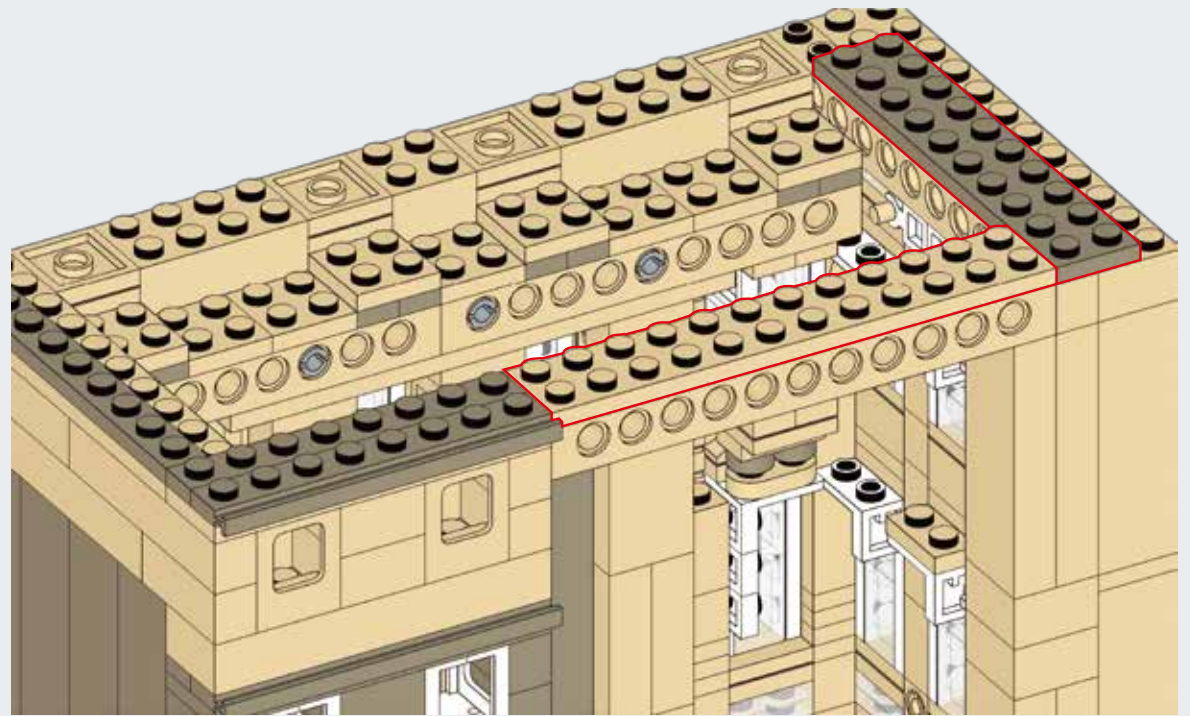

E168



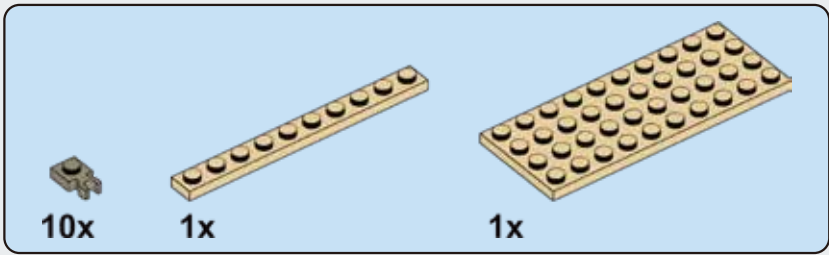

E169

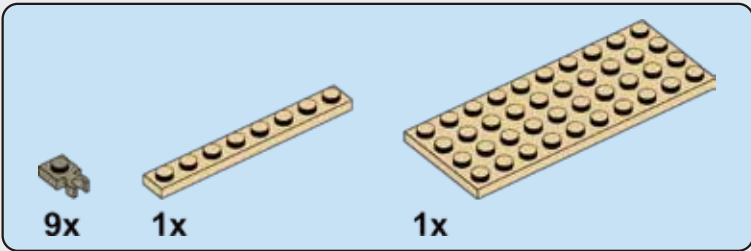
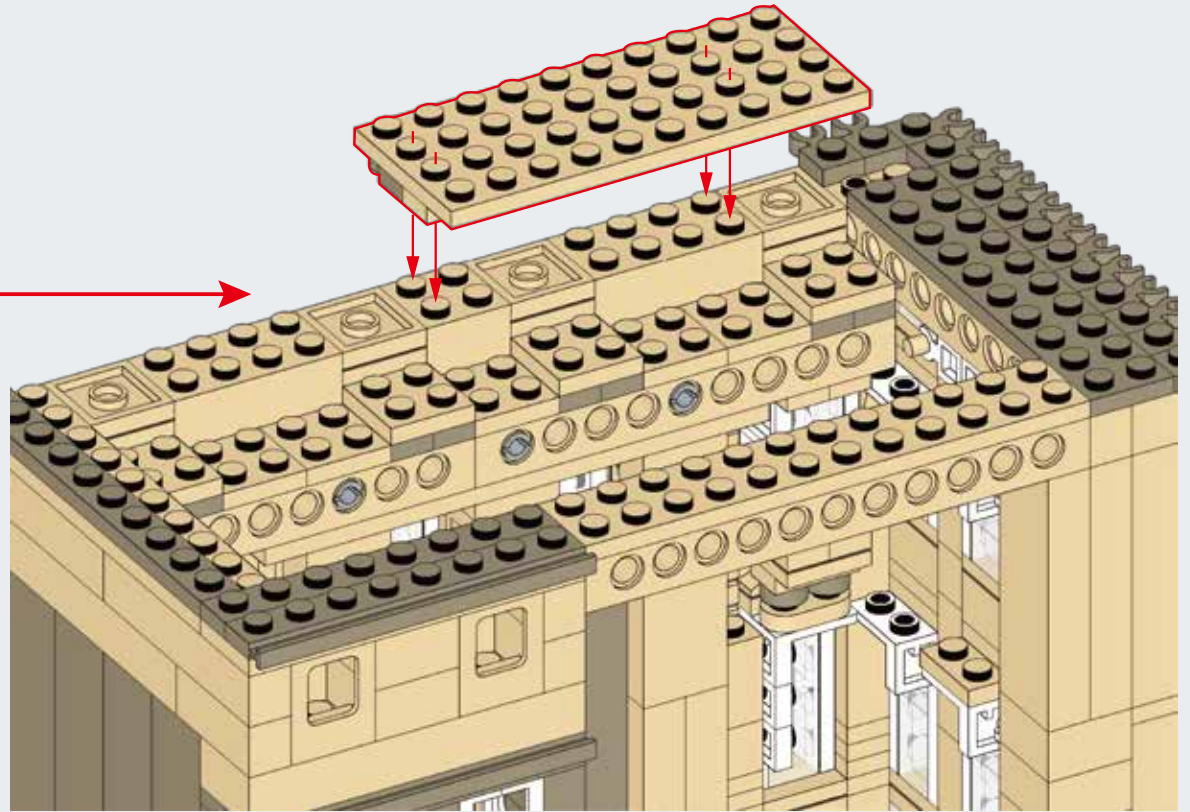
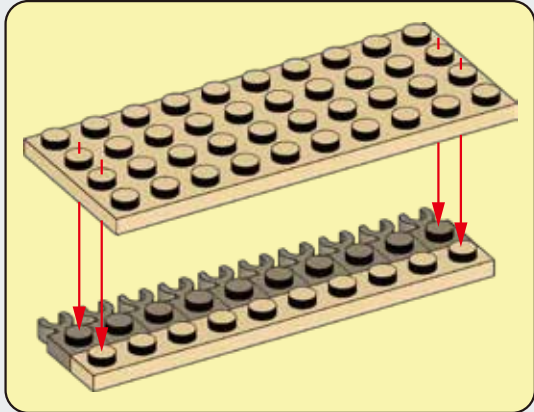

E170

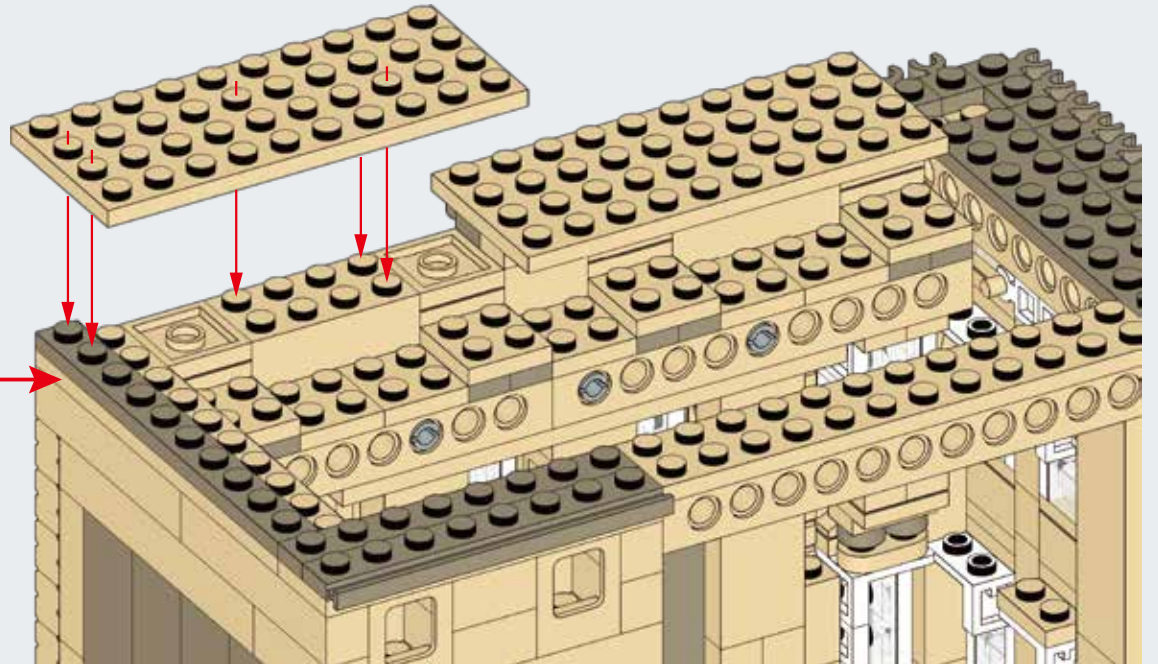
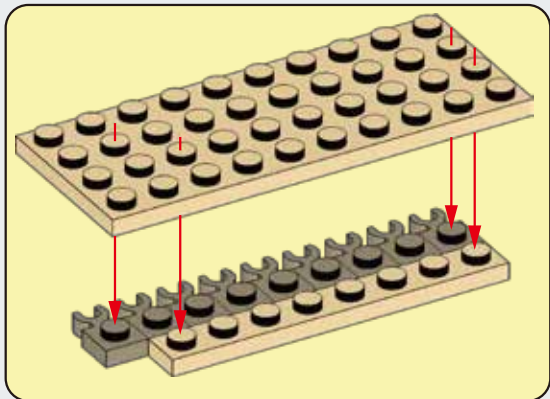

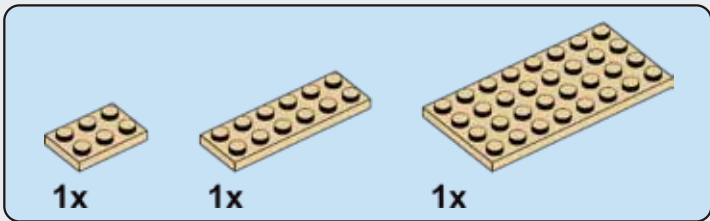

E171

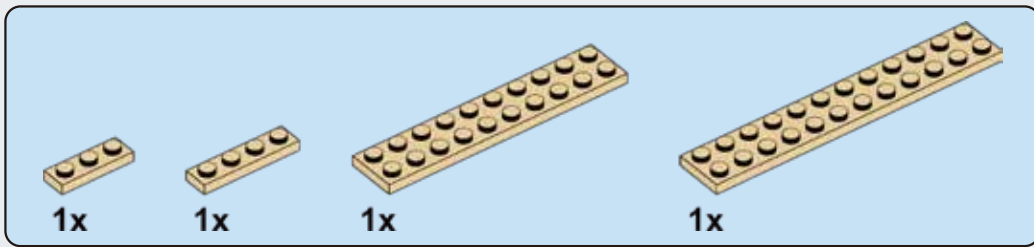
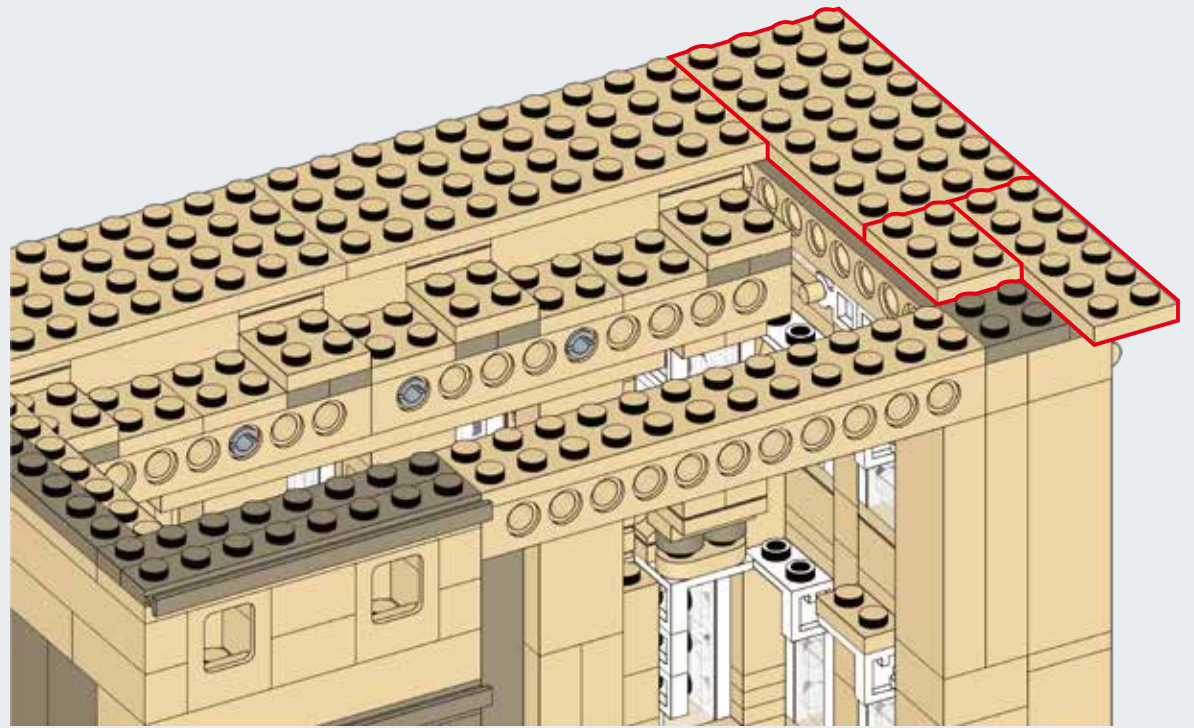

E172

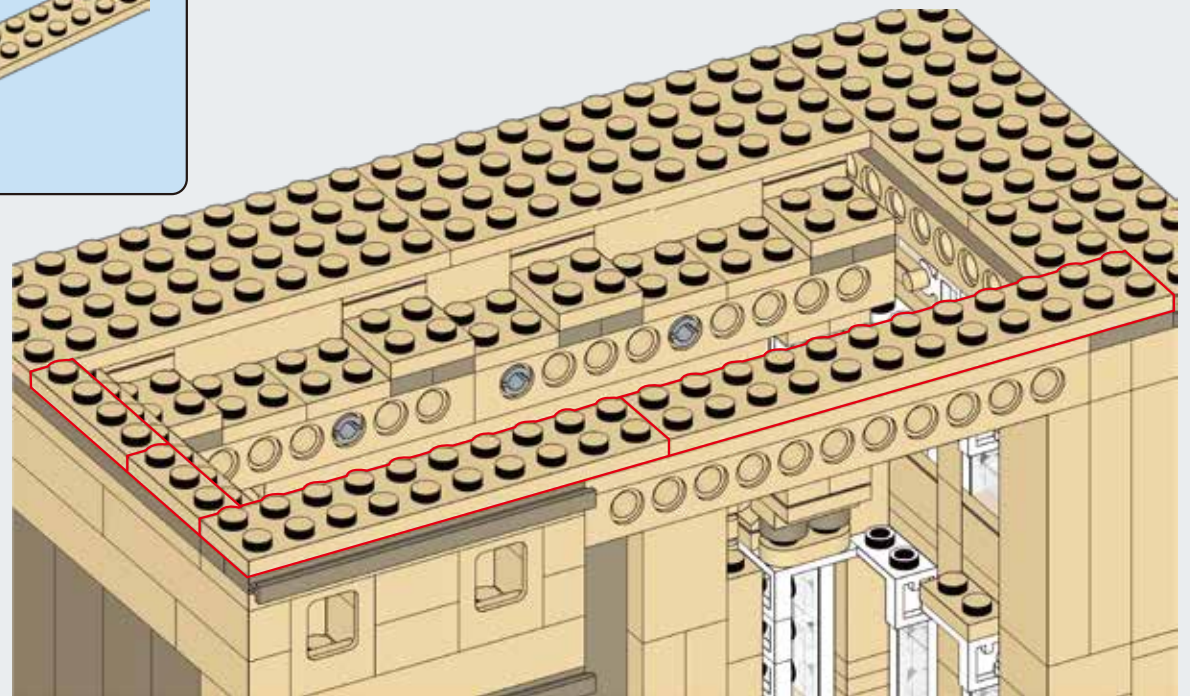

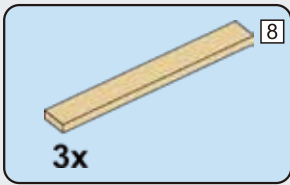

E173

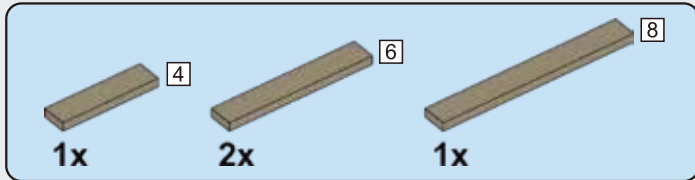
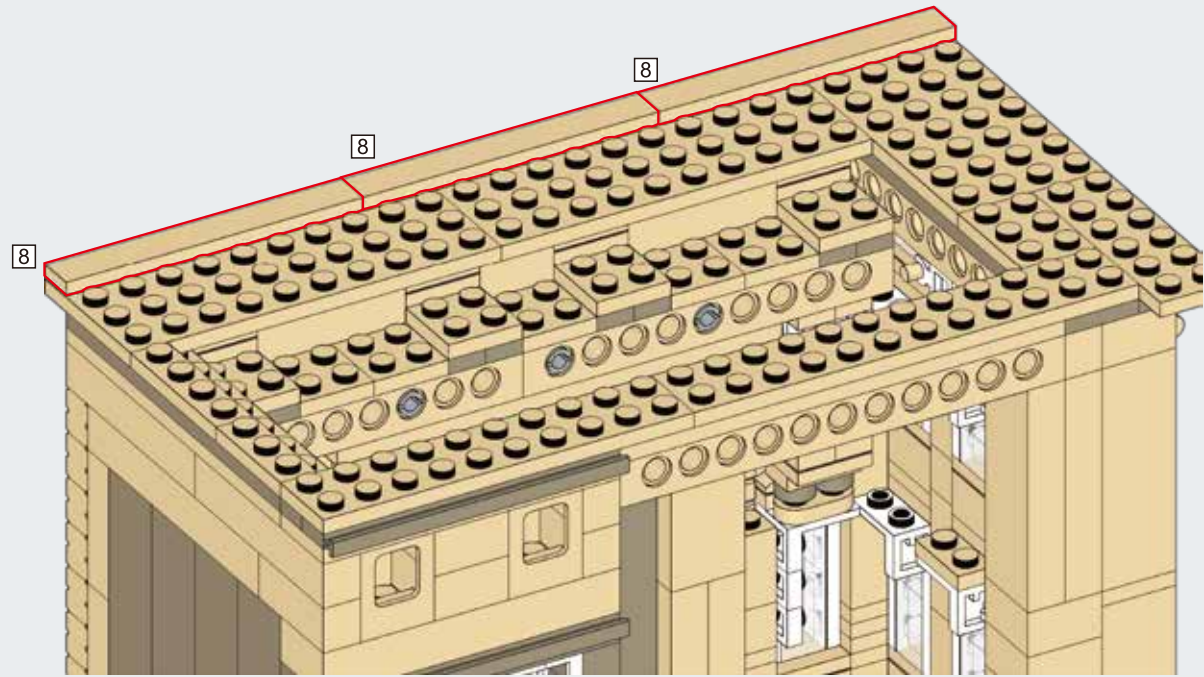

E174

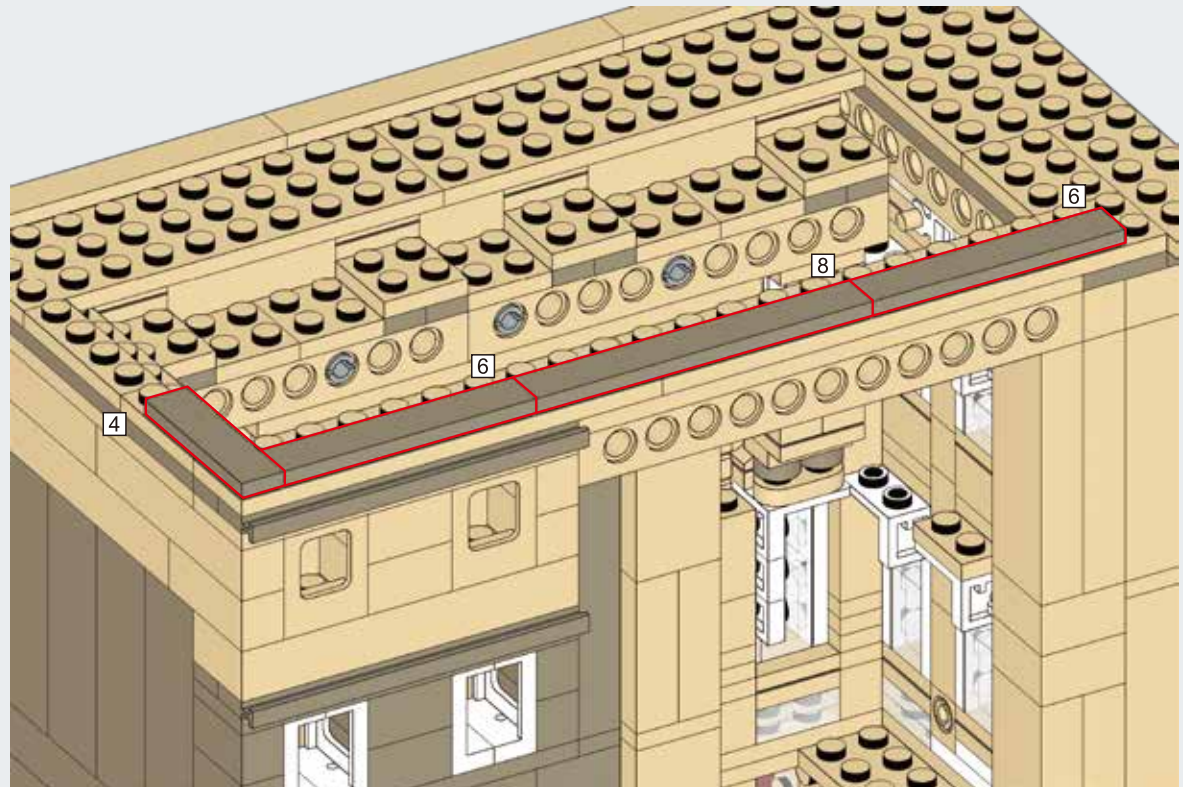



E175

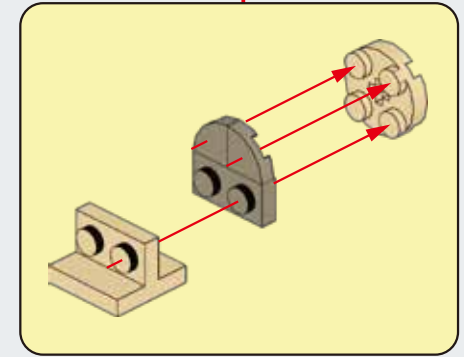
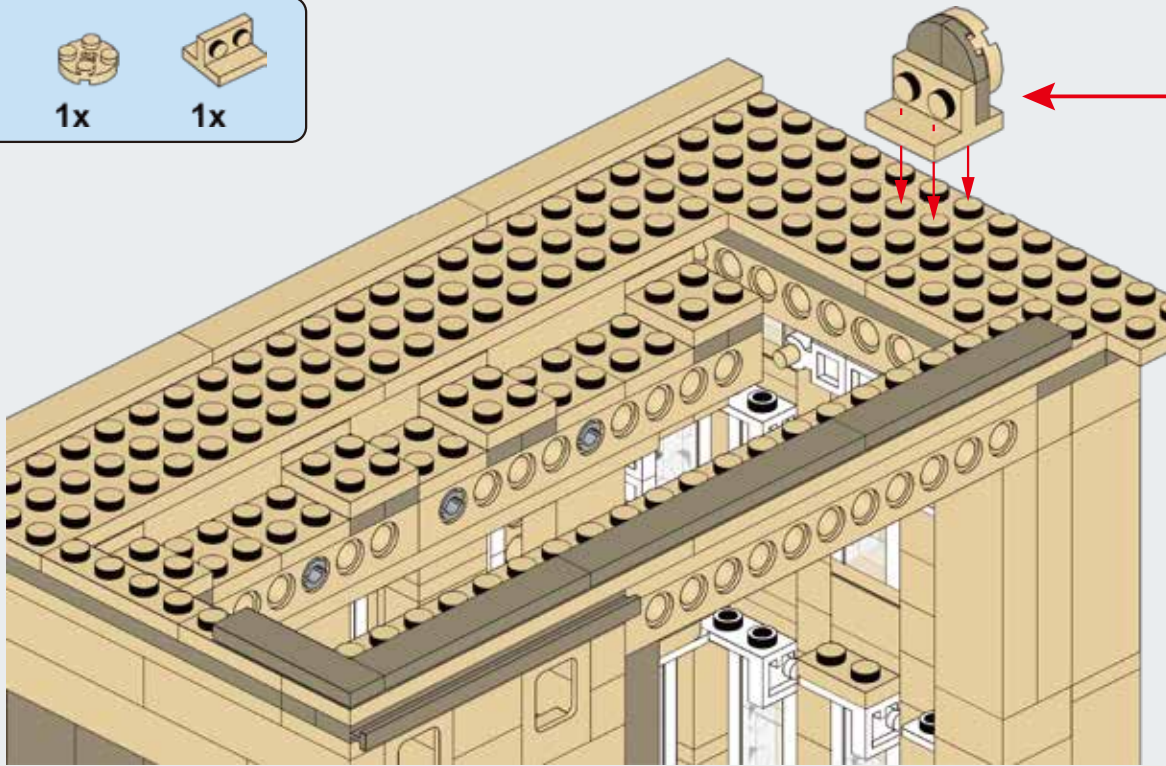

E176

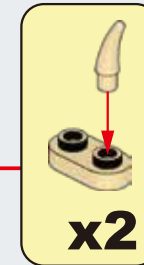
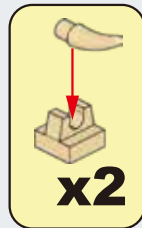
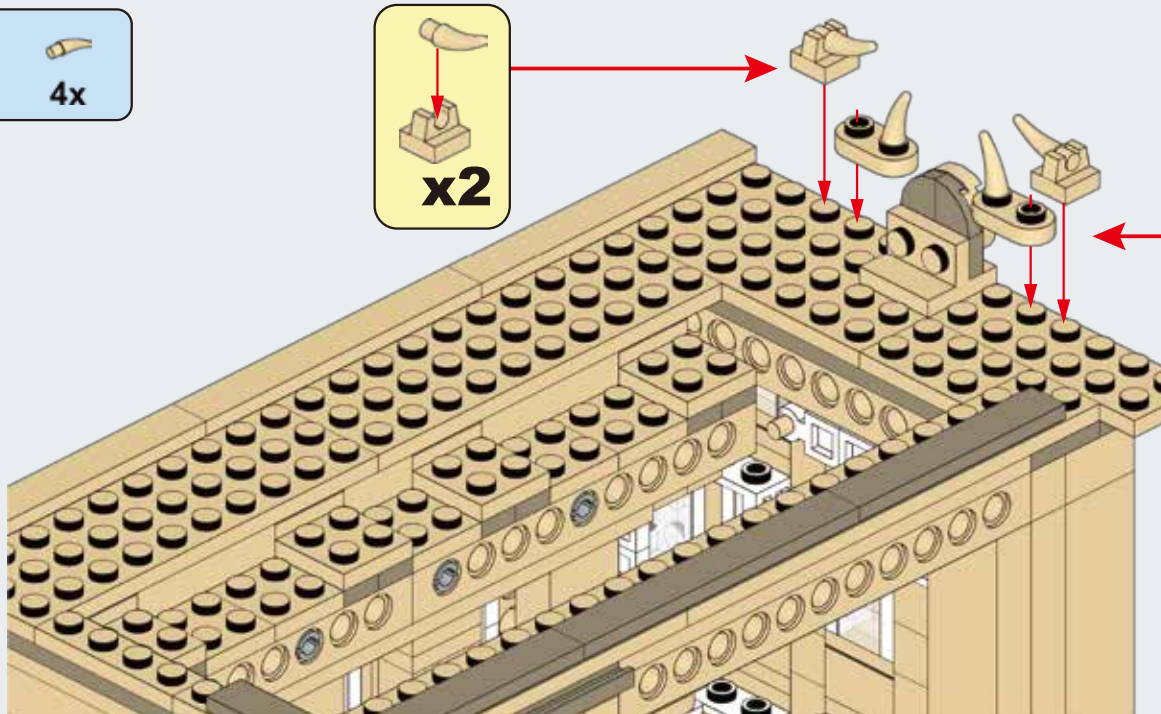

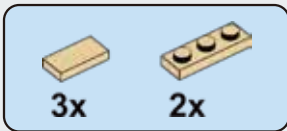

E177

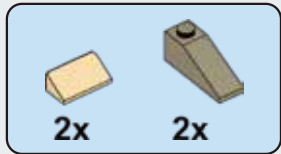
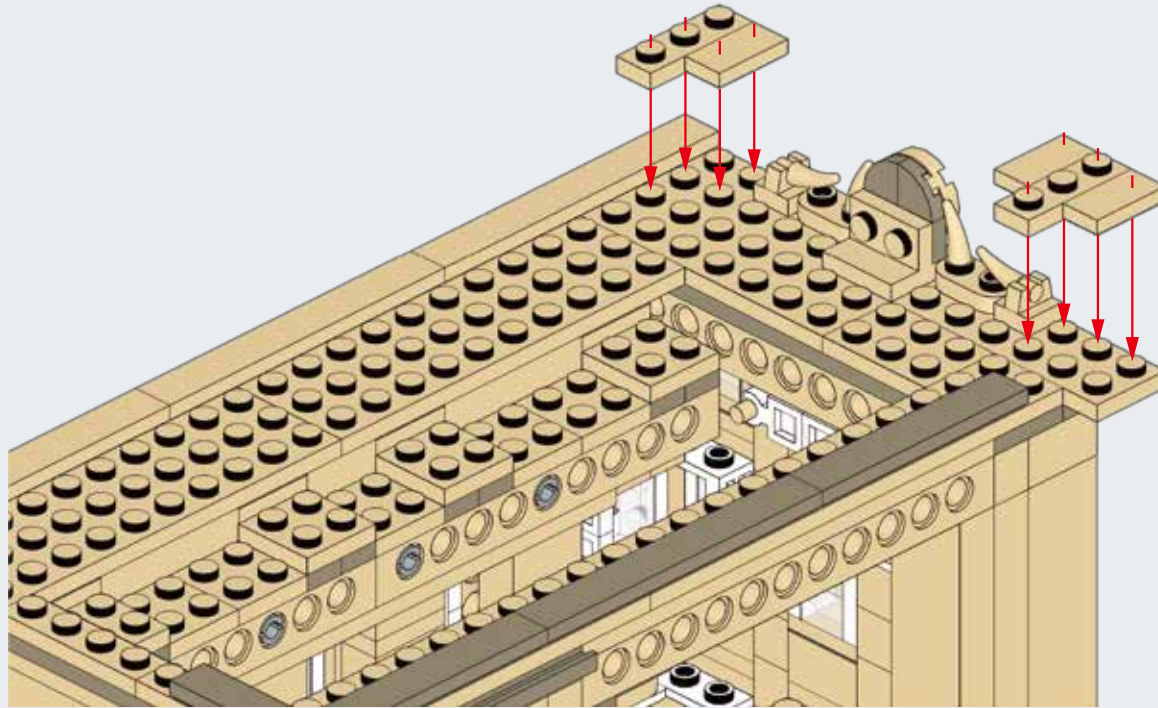

E178

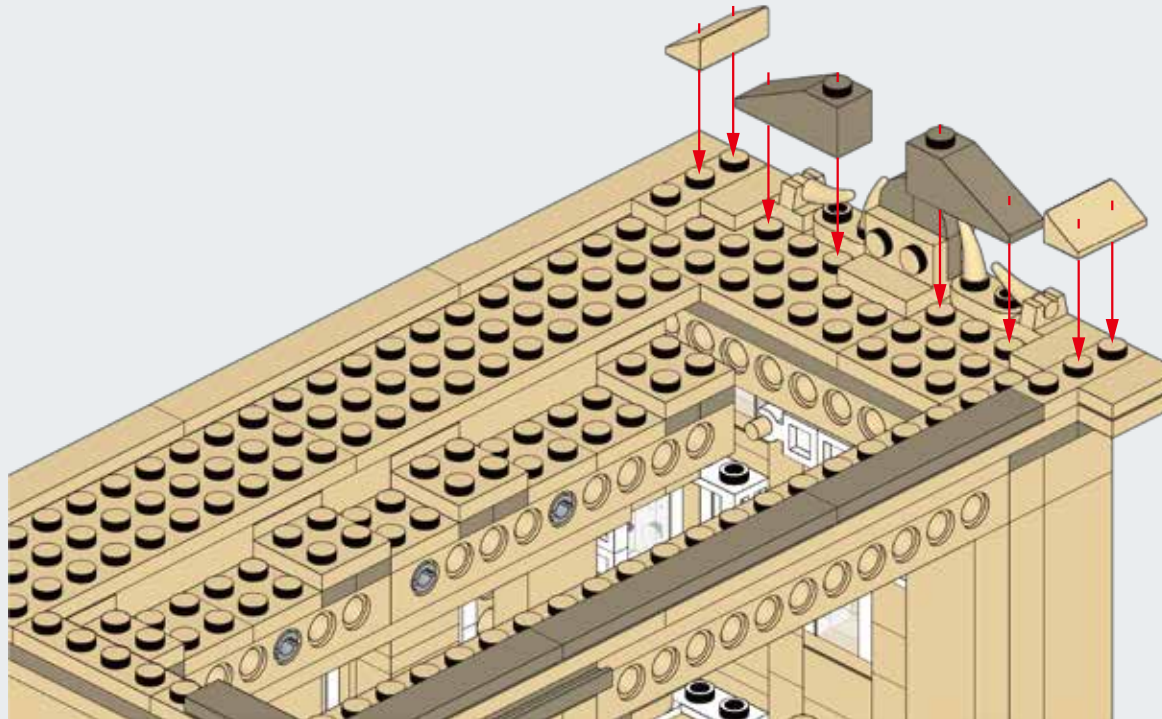

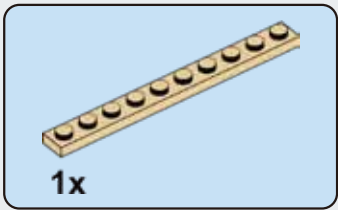

E179

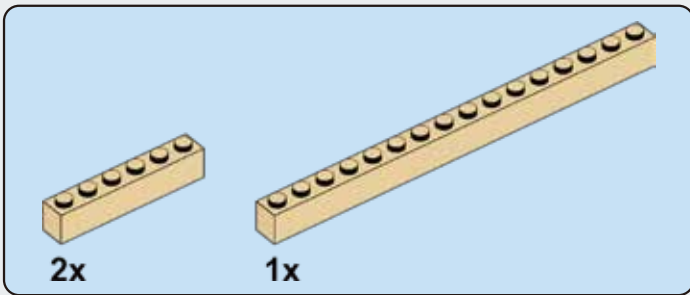
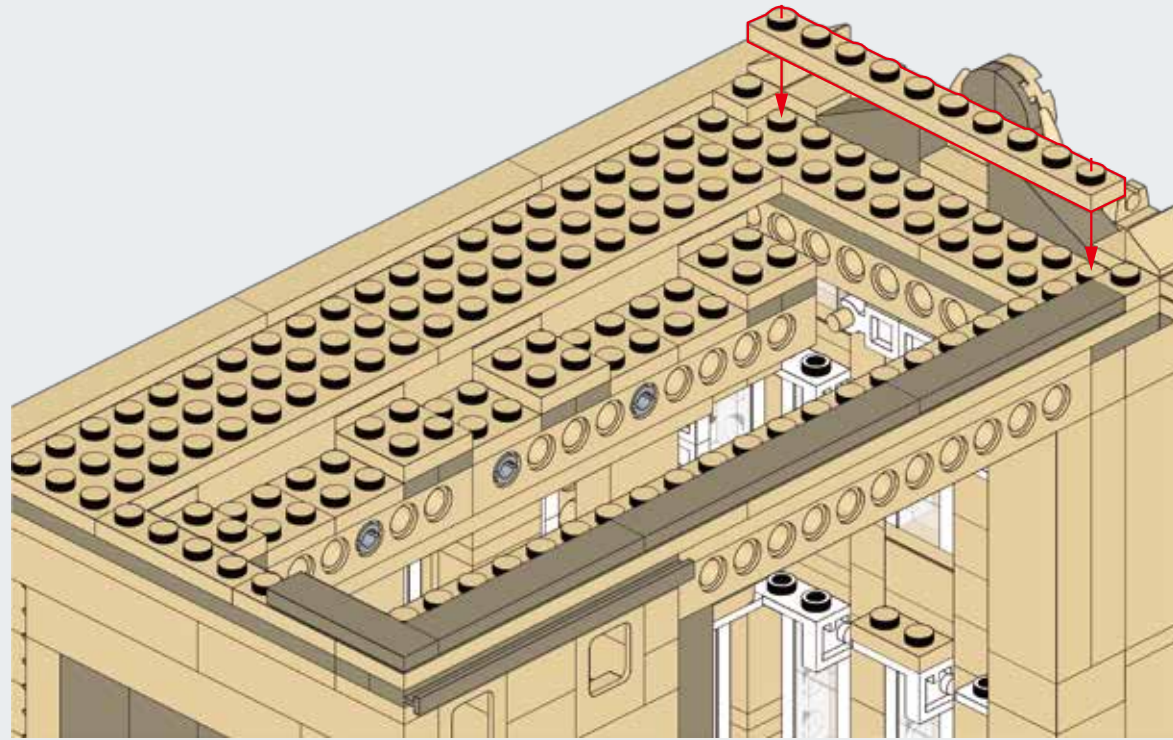

E180

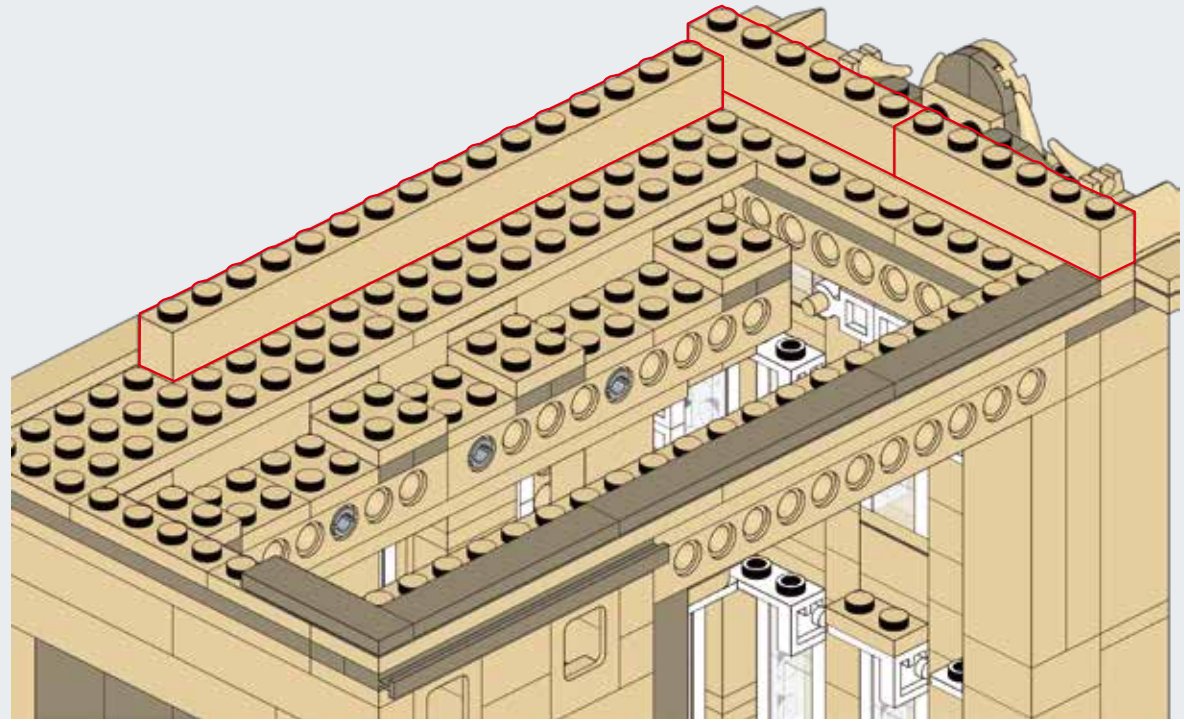

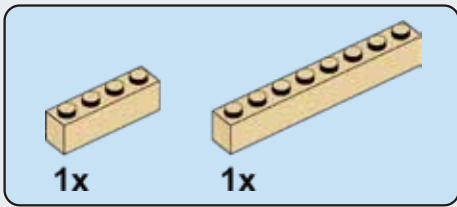

E181

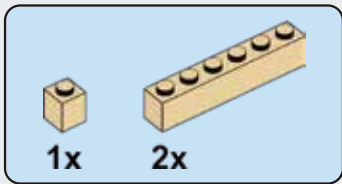
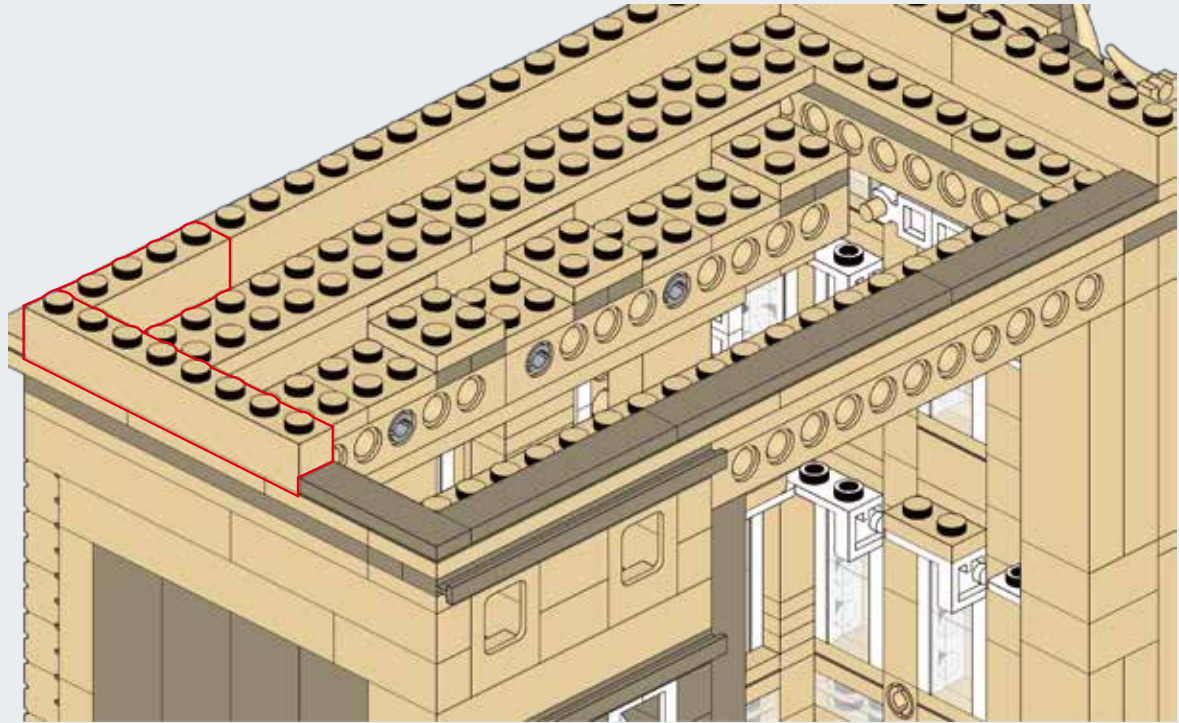

E182

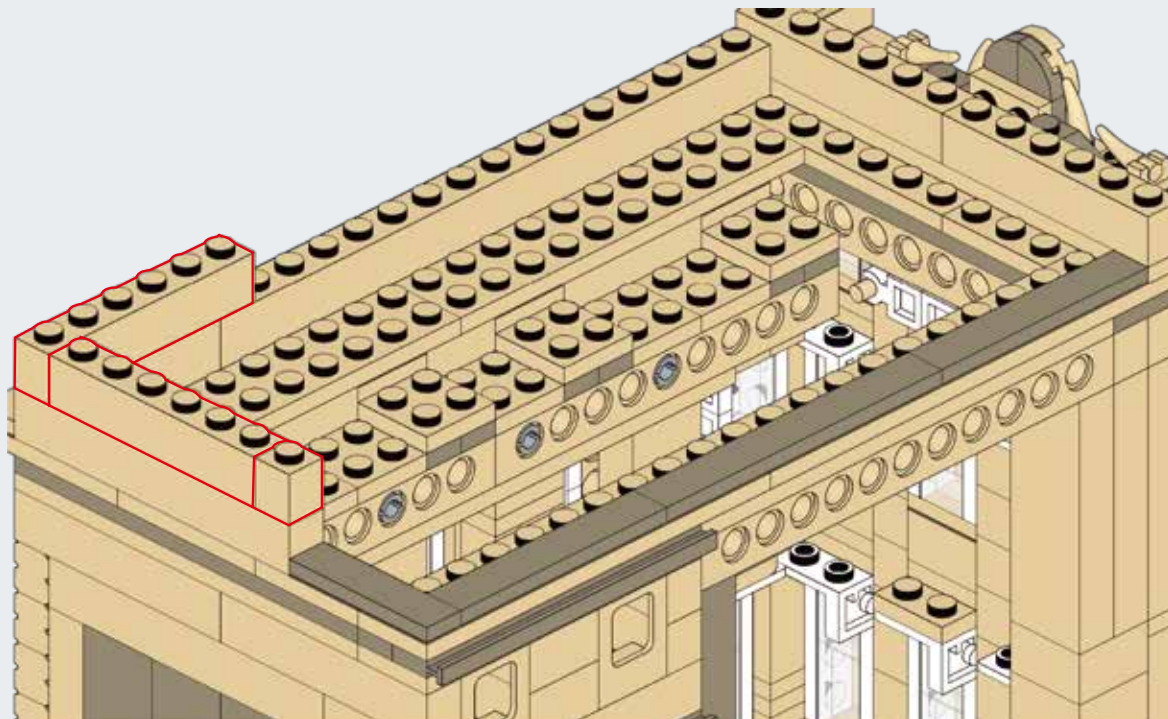

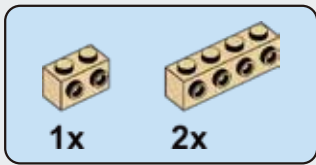

E183

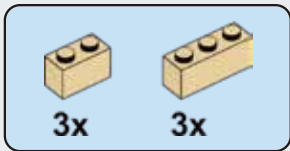
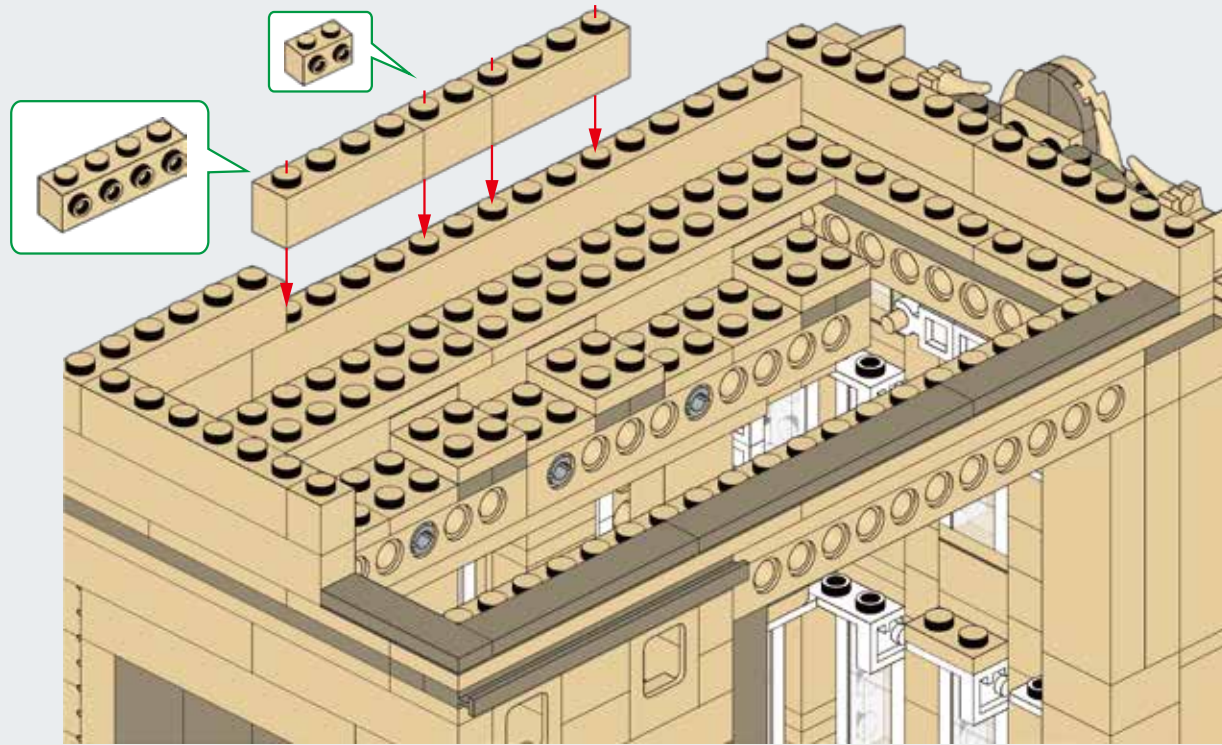

E184

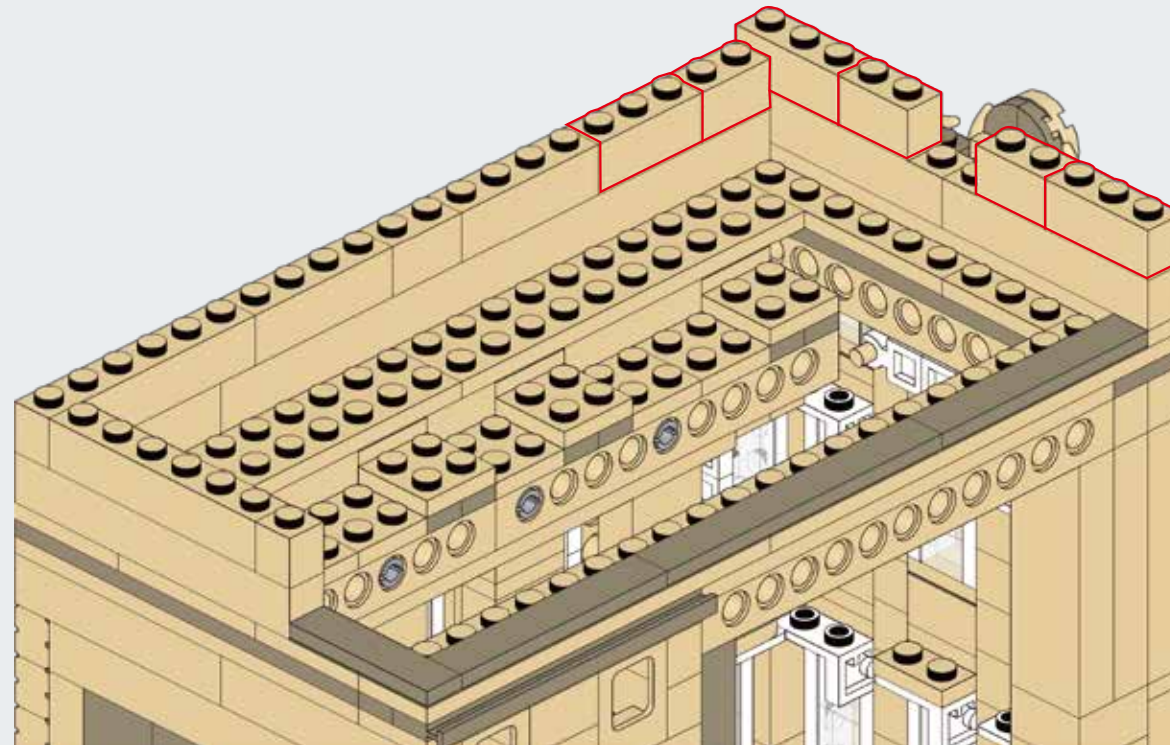

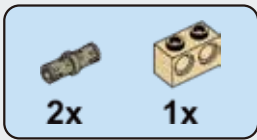

E185

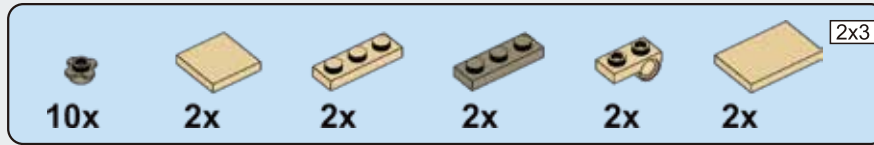
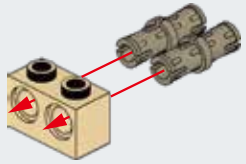

E186

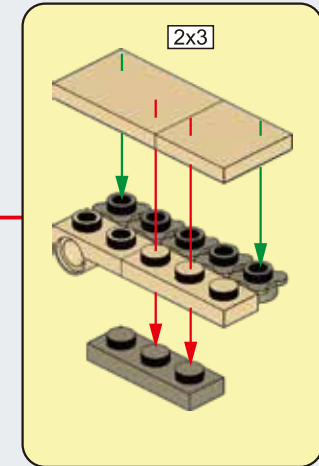
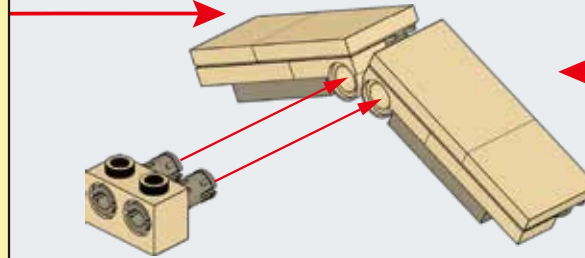
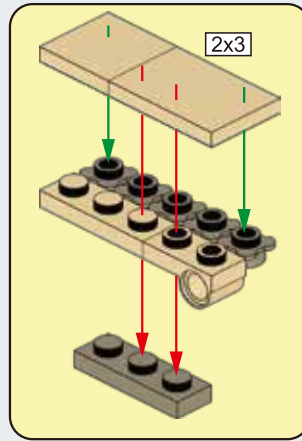

E187

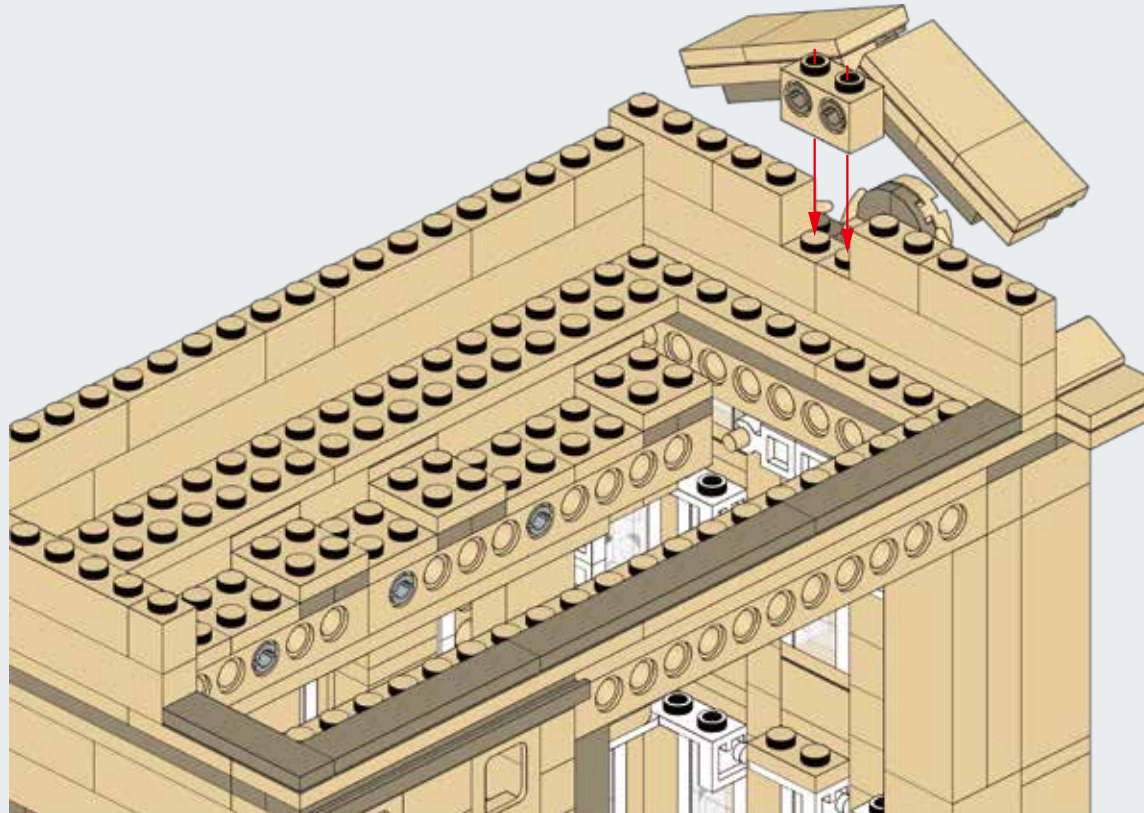

E184

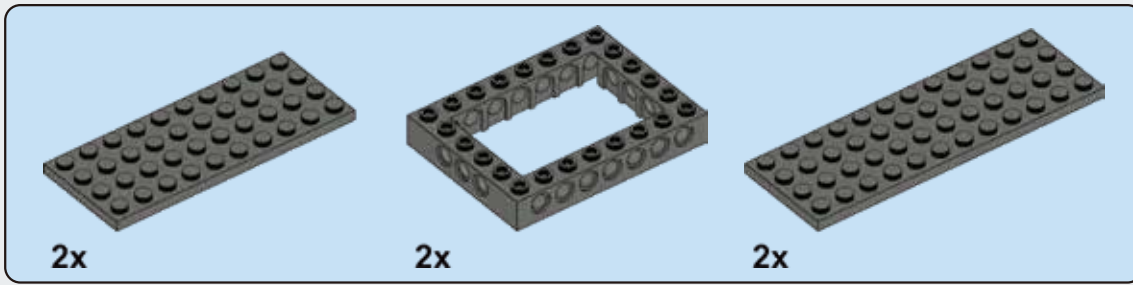

E188

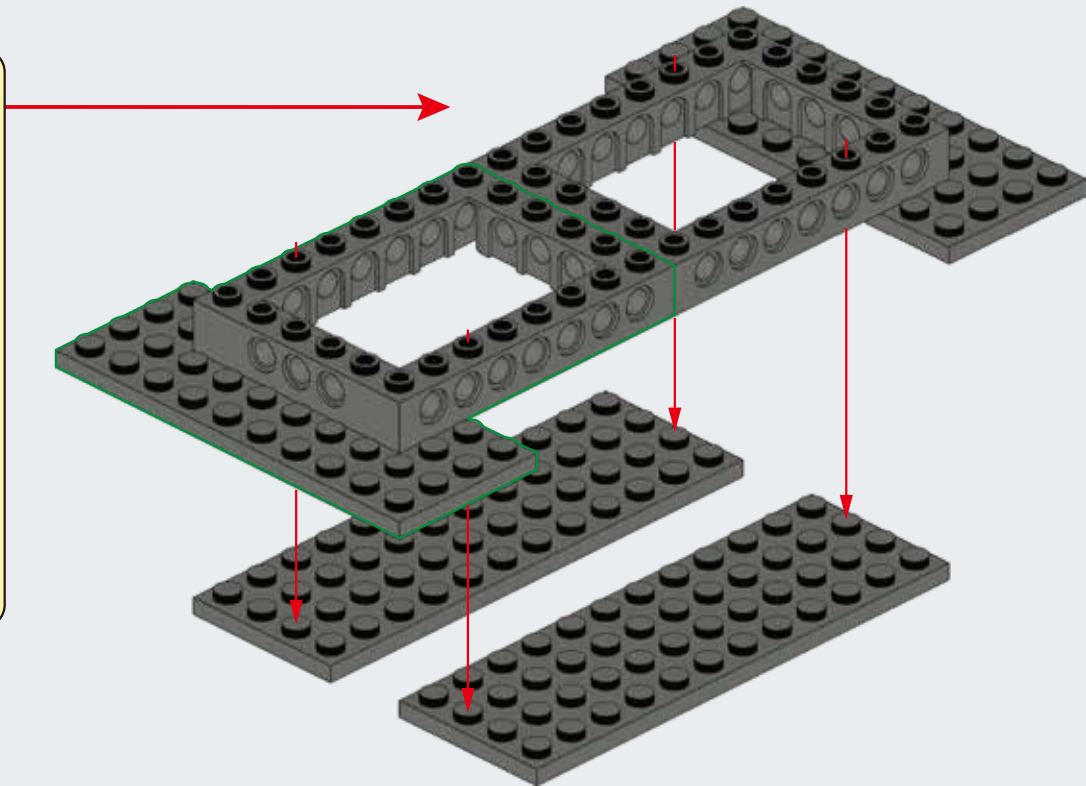
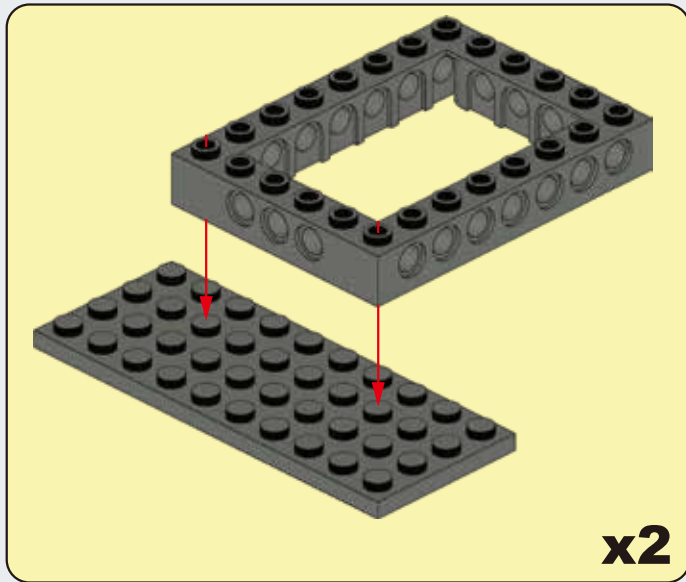

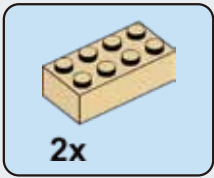

E189

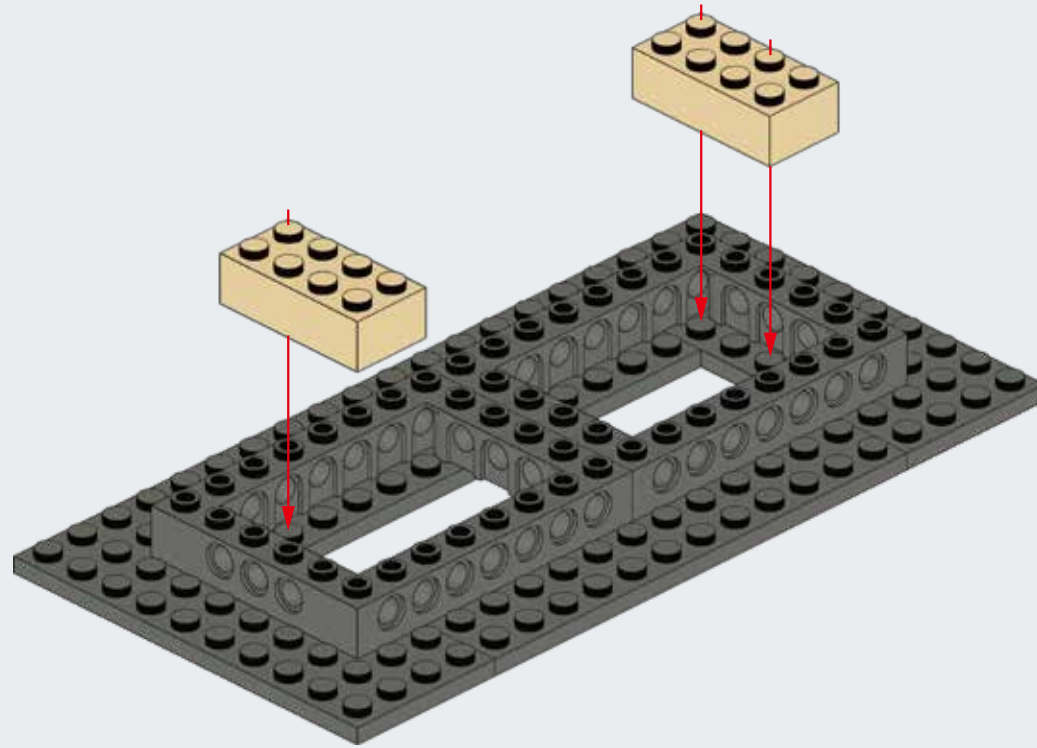

E190

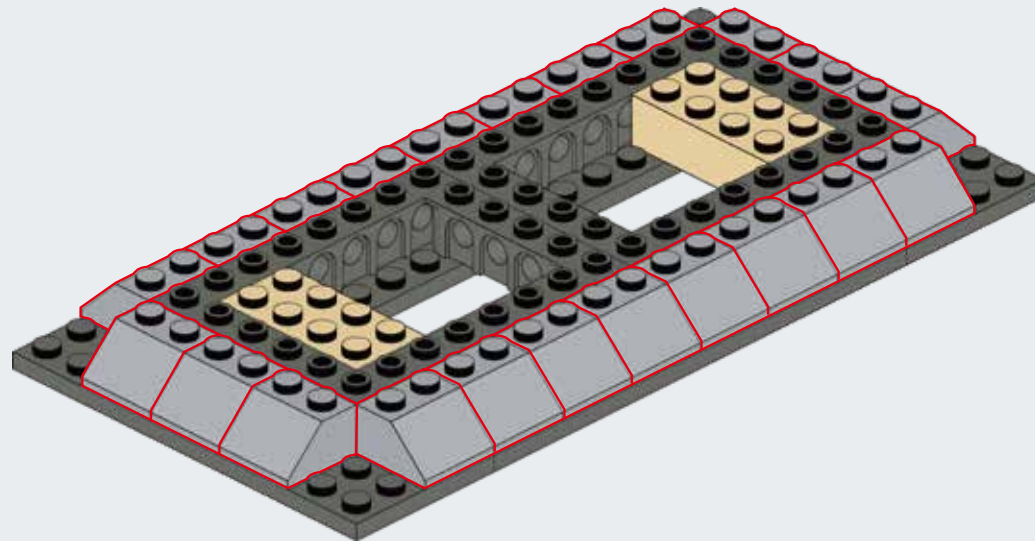



E191

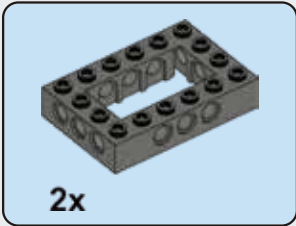
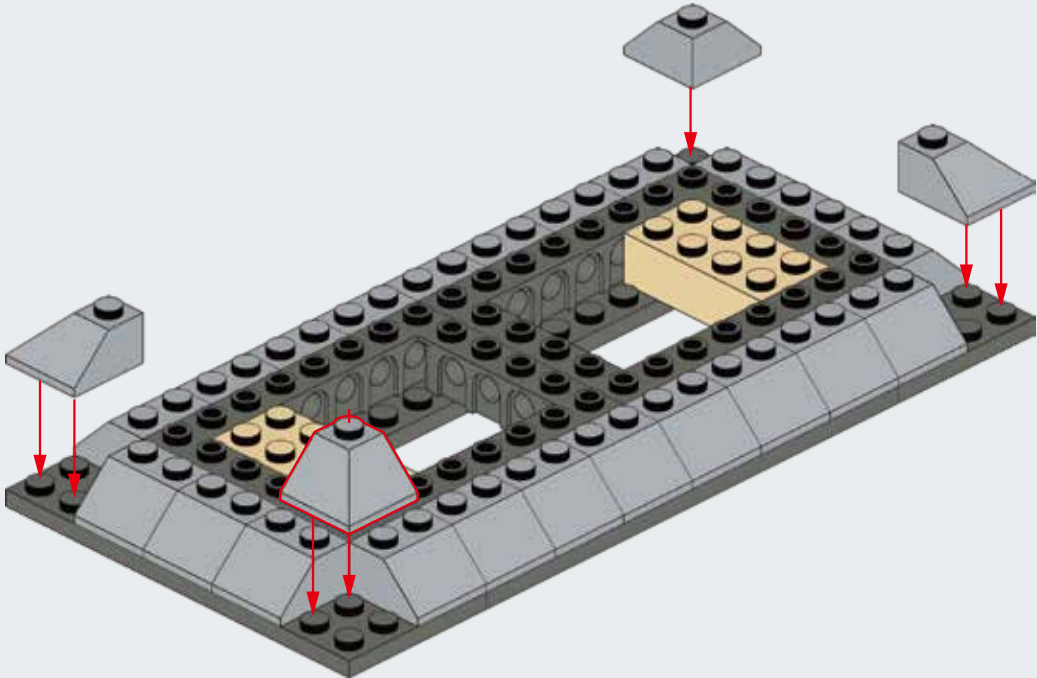

E192

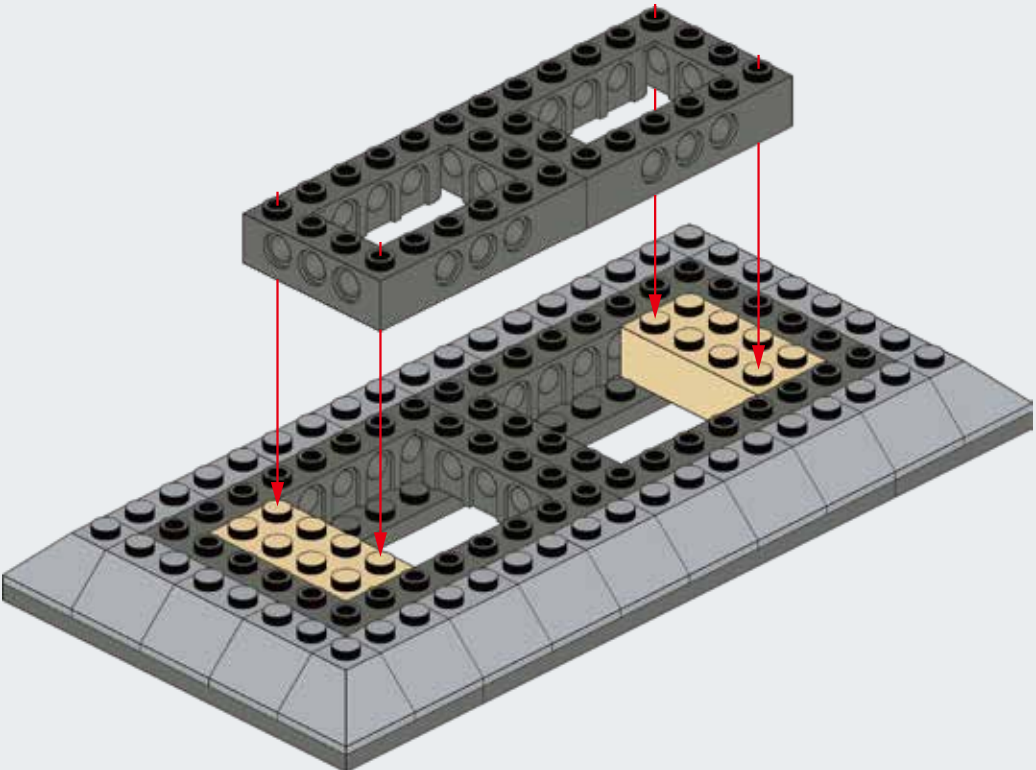



E193

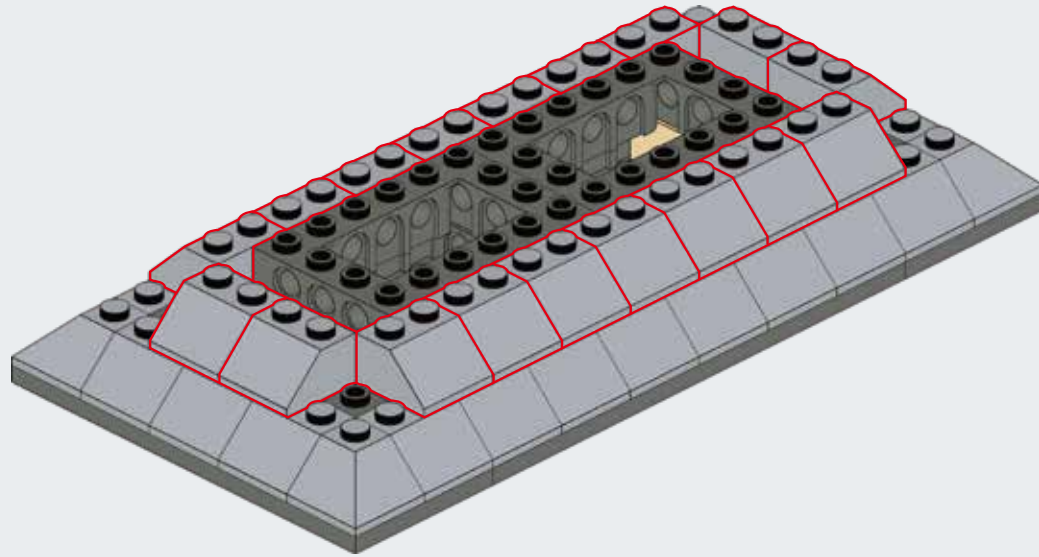

E194

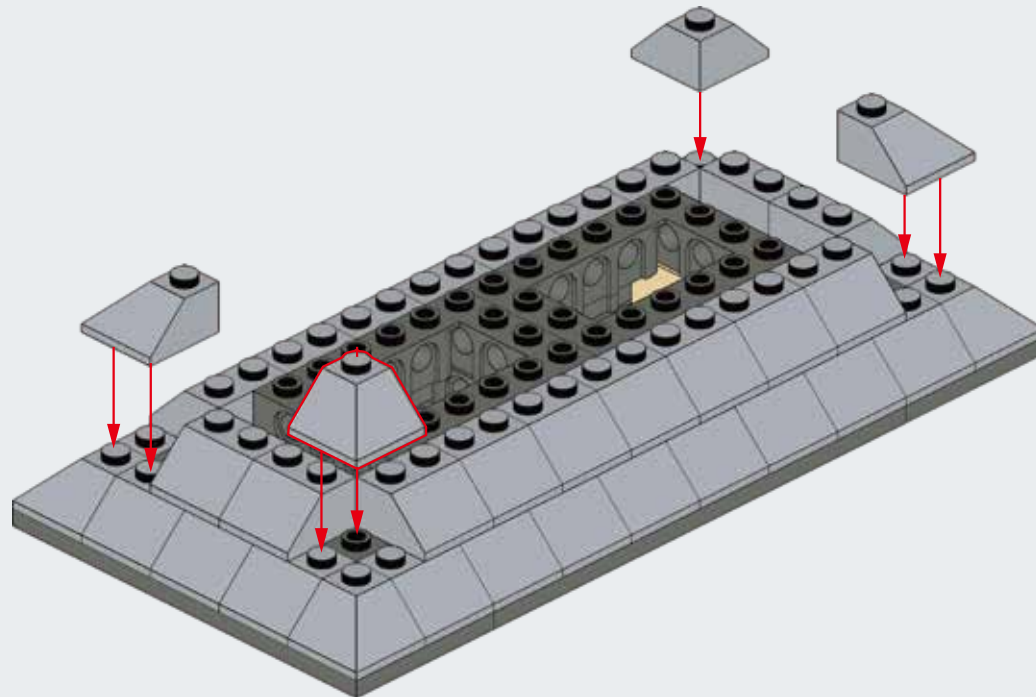

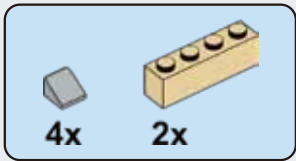

E195

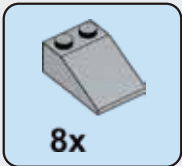
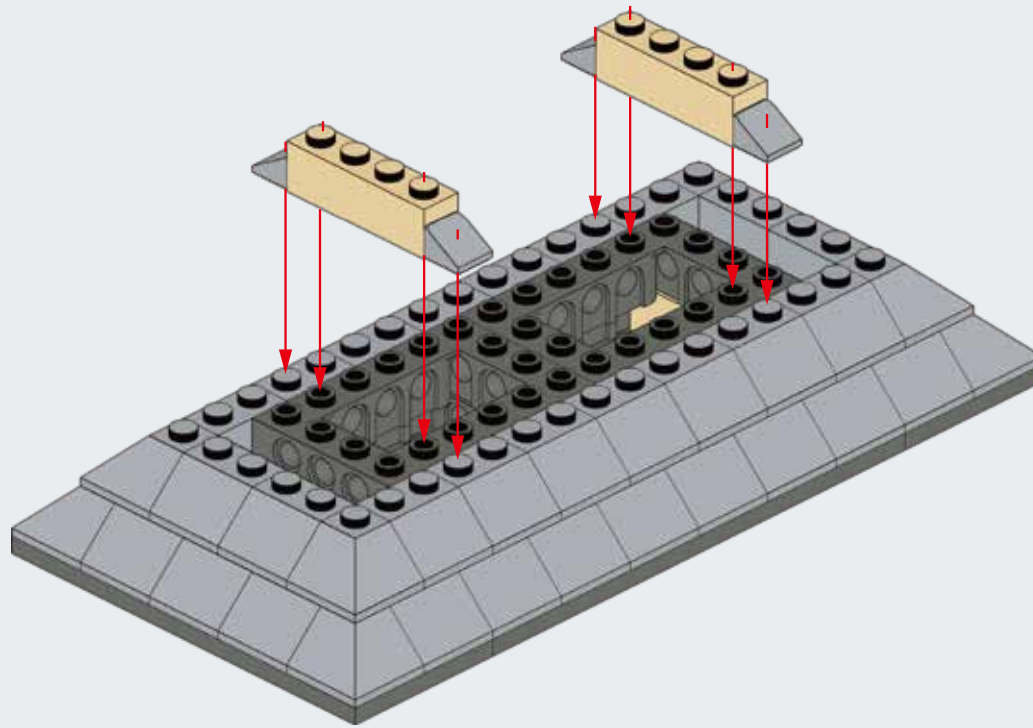

E196

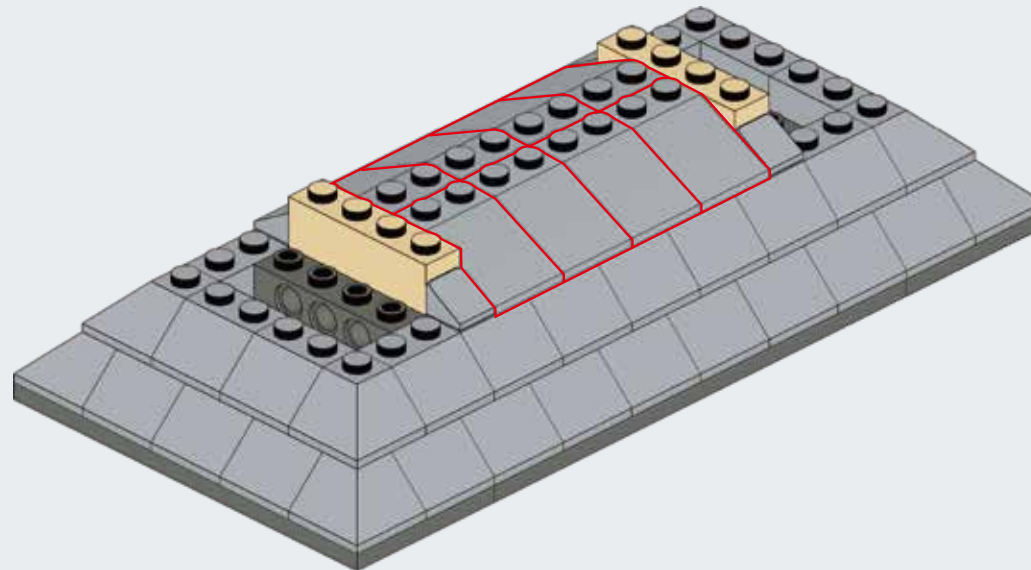

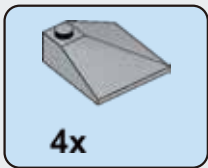

E197

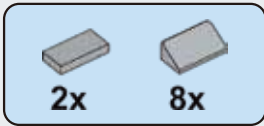
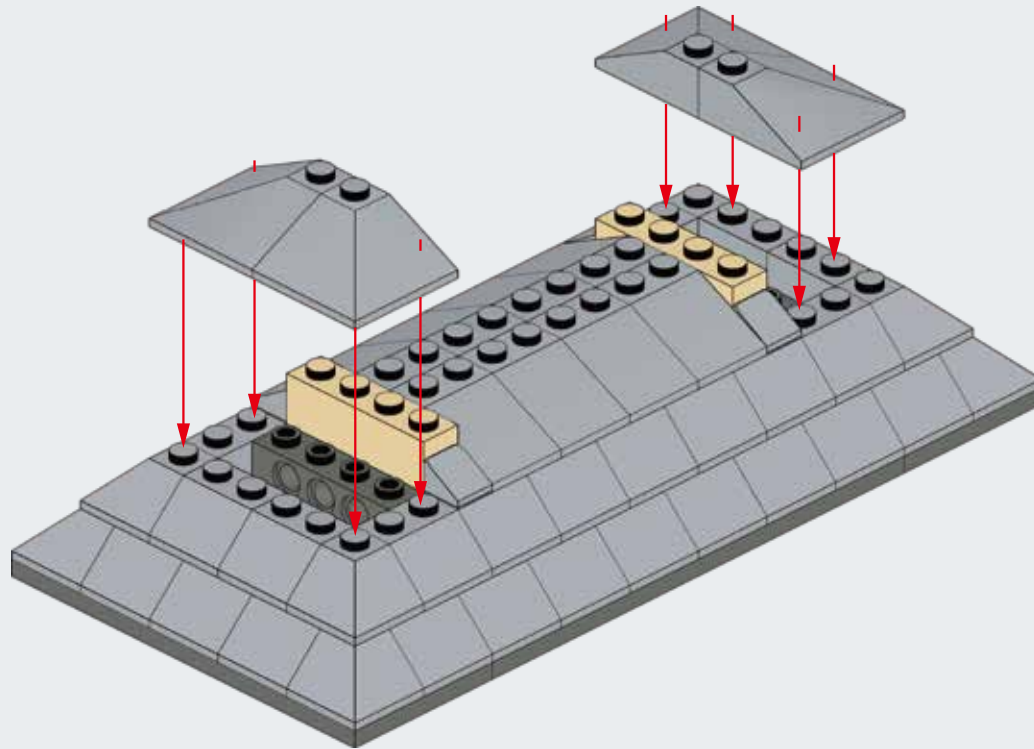

E198

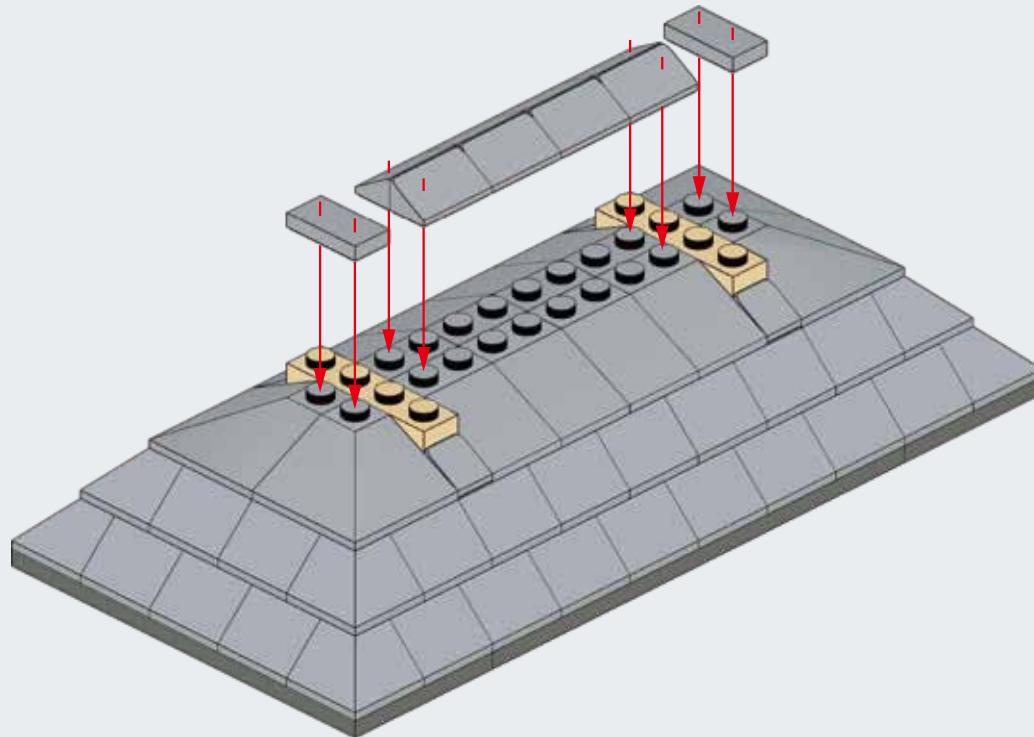

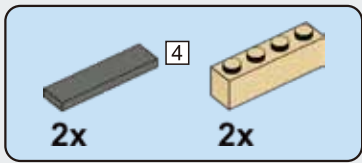

E199

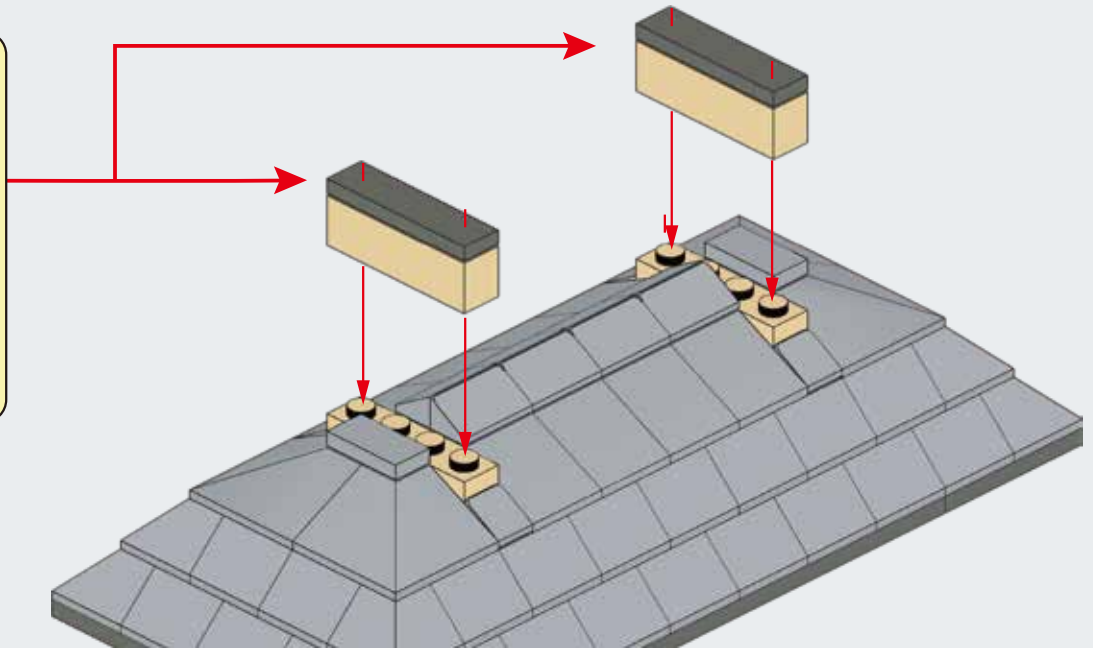
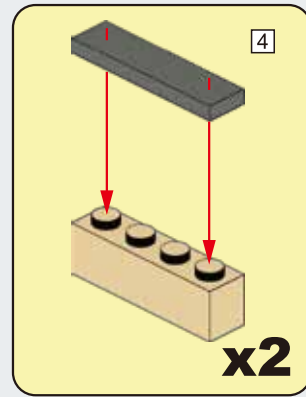

E200

E187

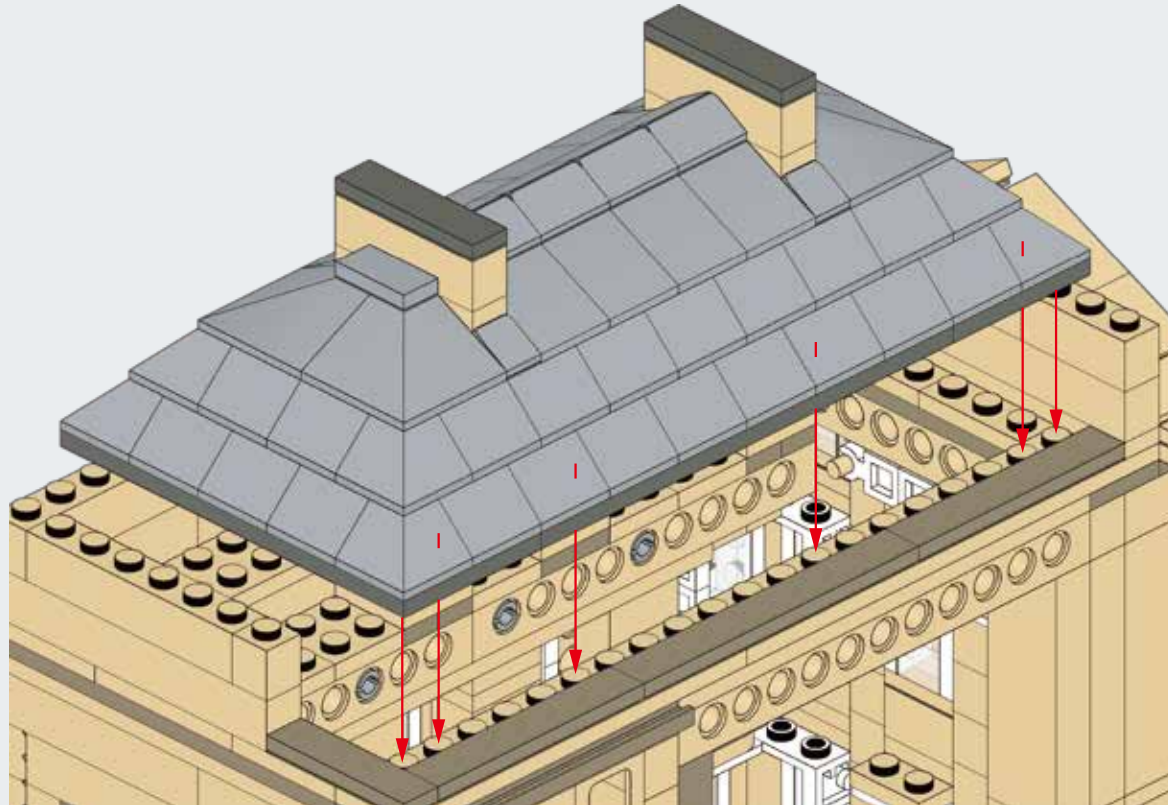

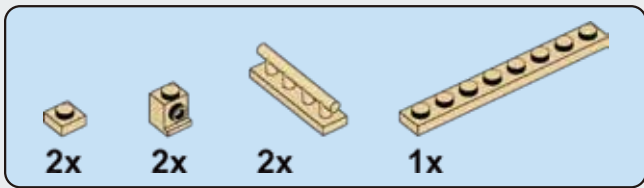

E201

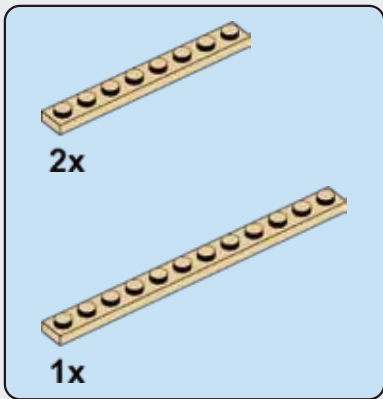
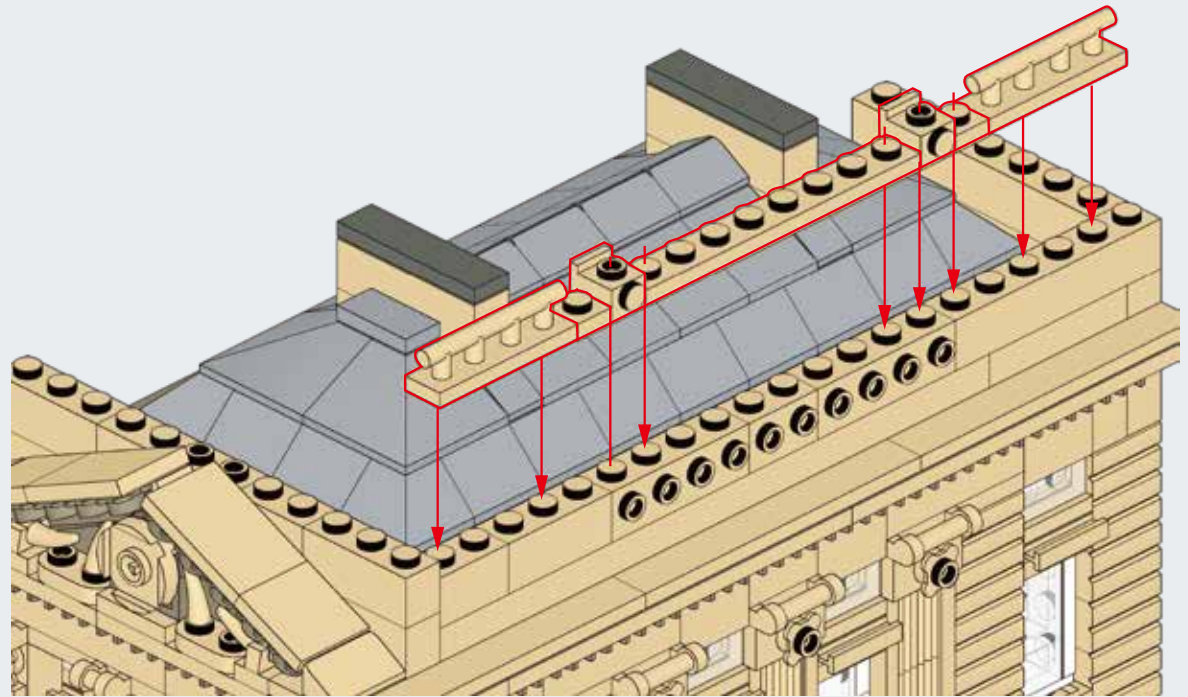
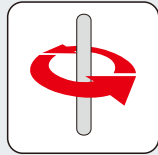

E202

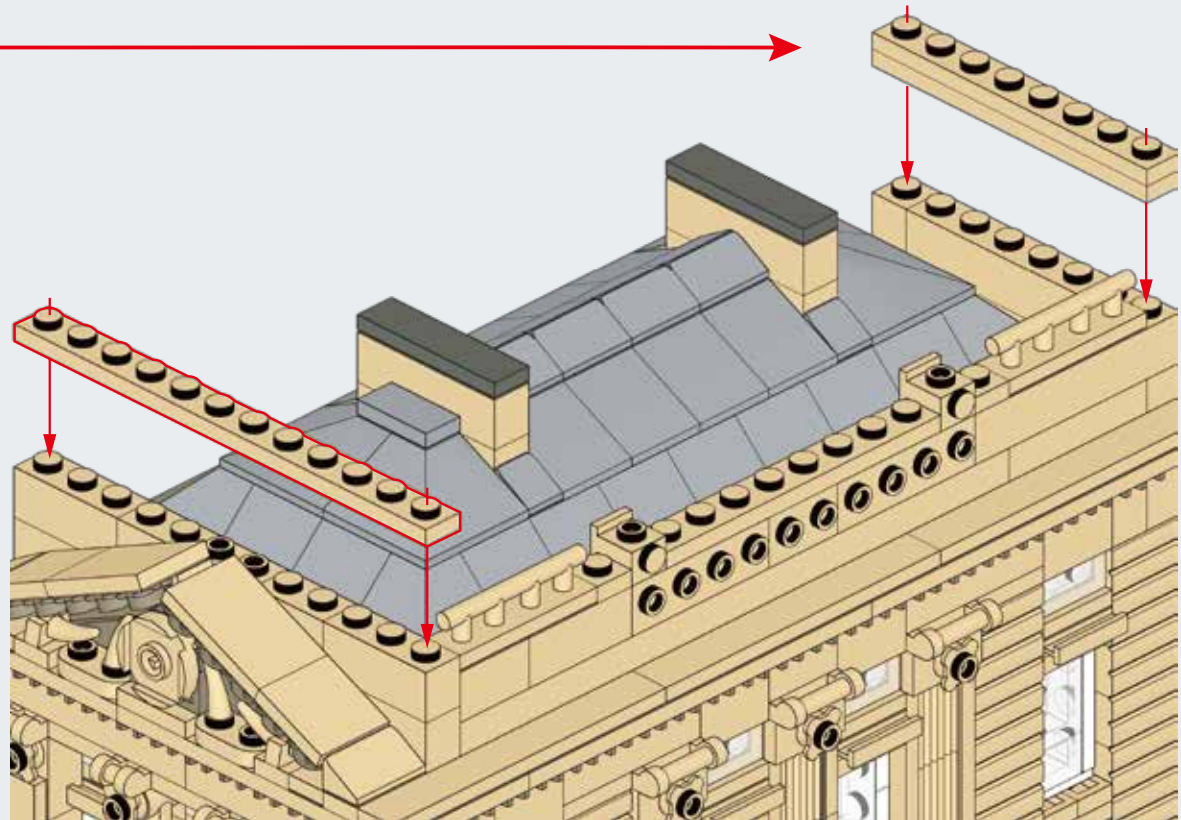
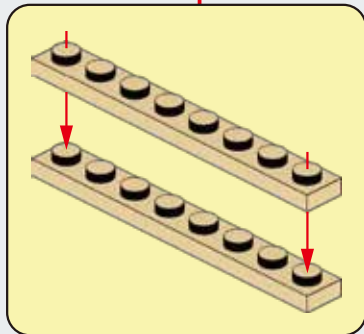

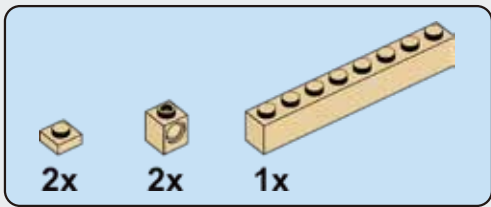

E203

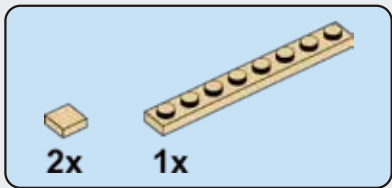
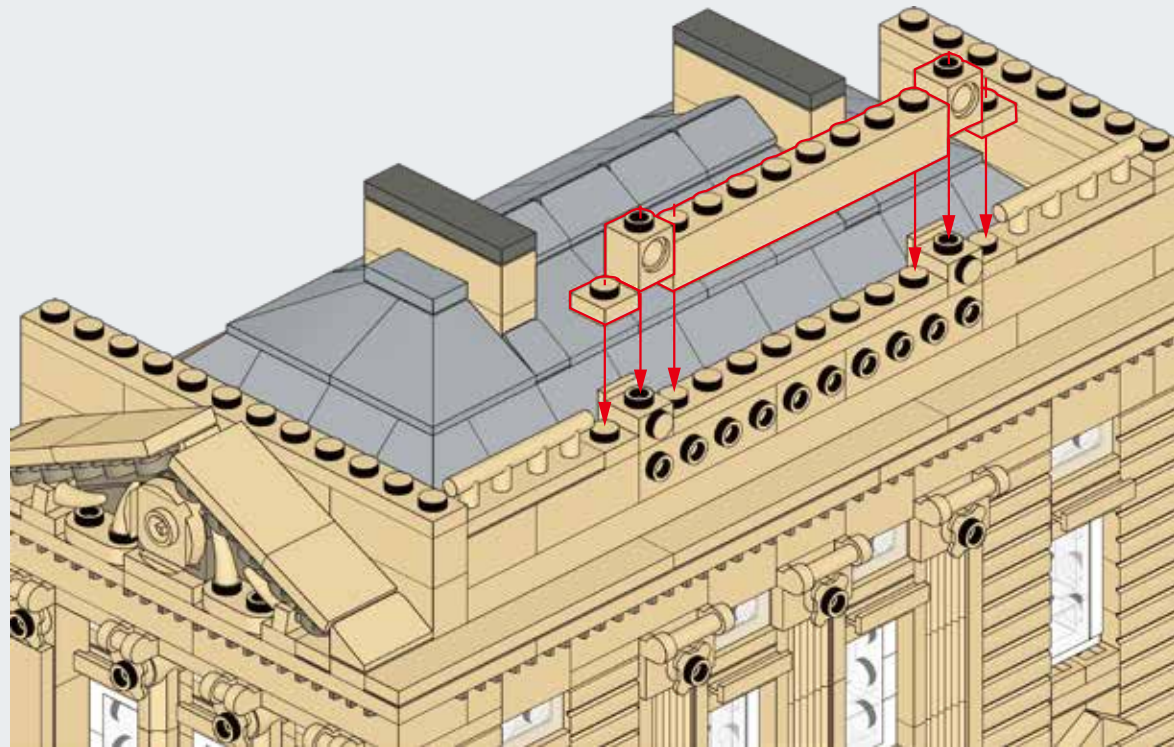

E204

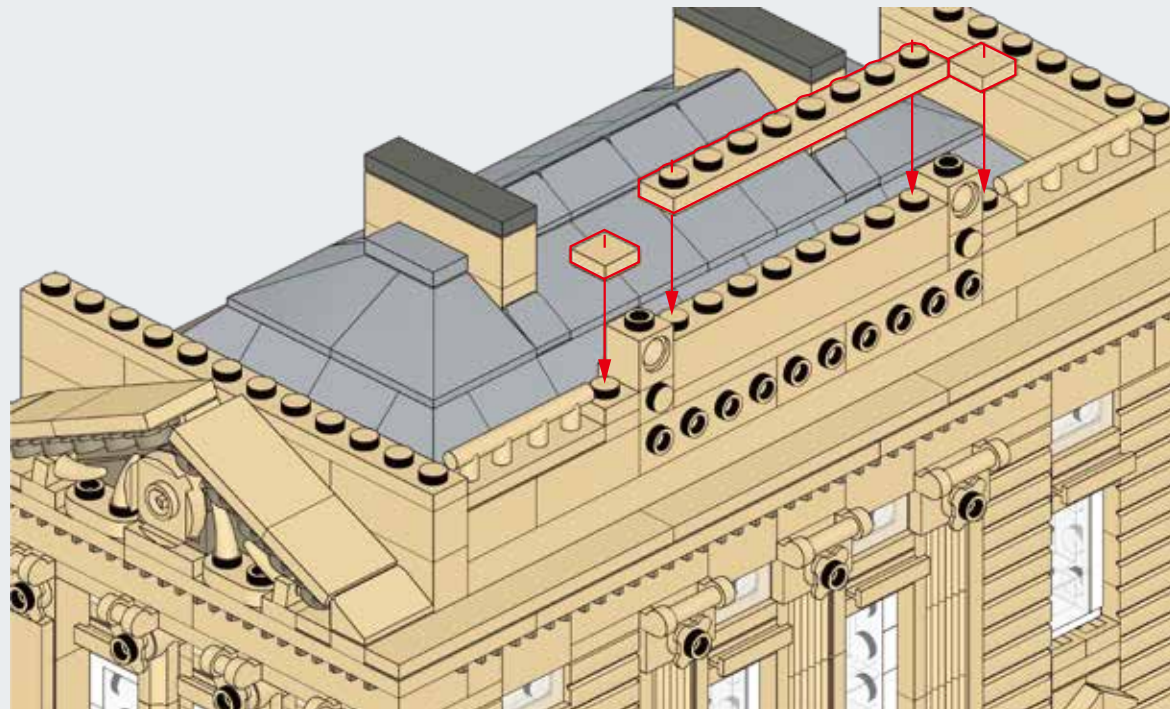



Buckingham Palace



Please download the building instruction from below website.

en.doubleeagle-group.com

403ARC615010006

C61501

5604PCS

Designer: Tobias Thieme