

**C78**

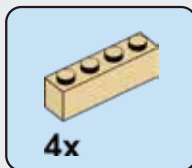

**C79**

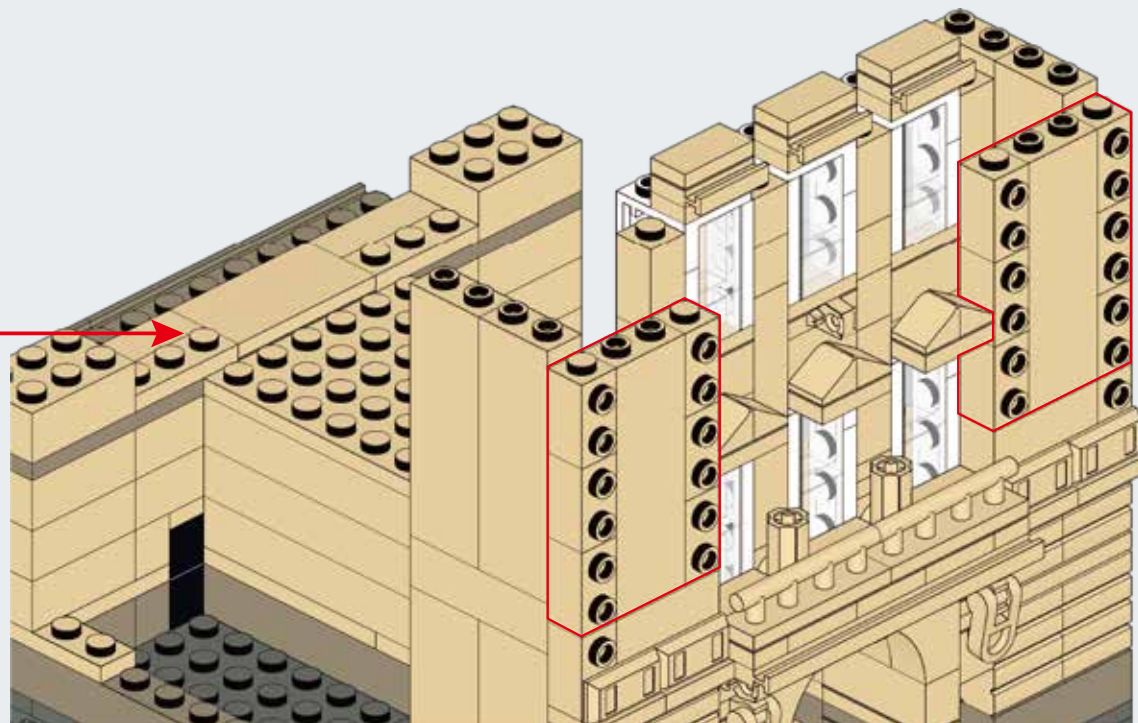

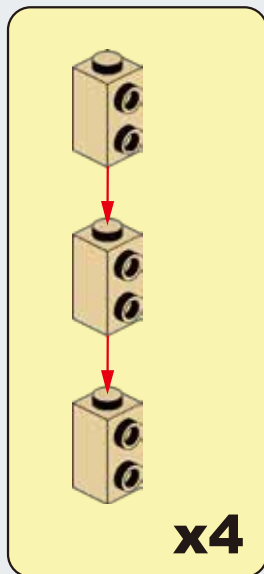
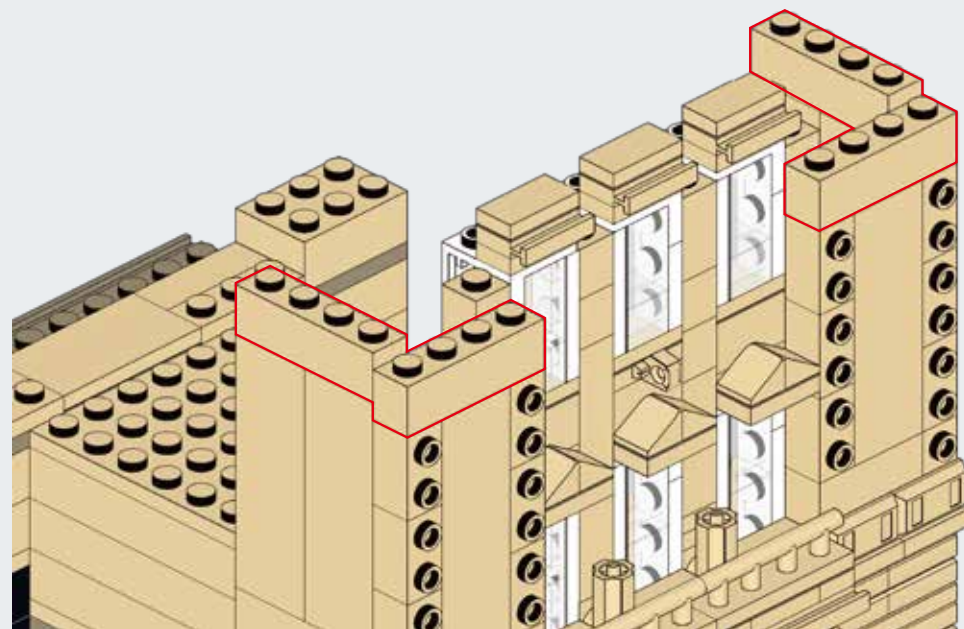
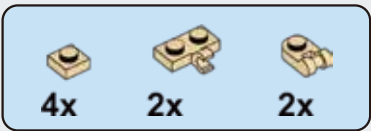

# C80

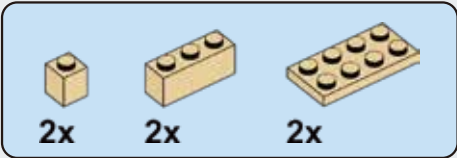
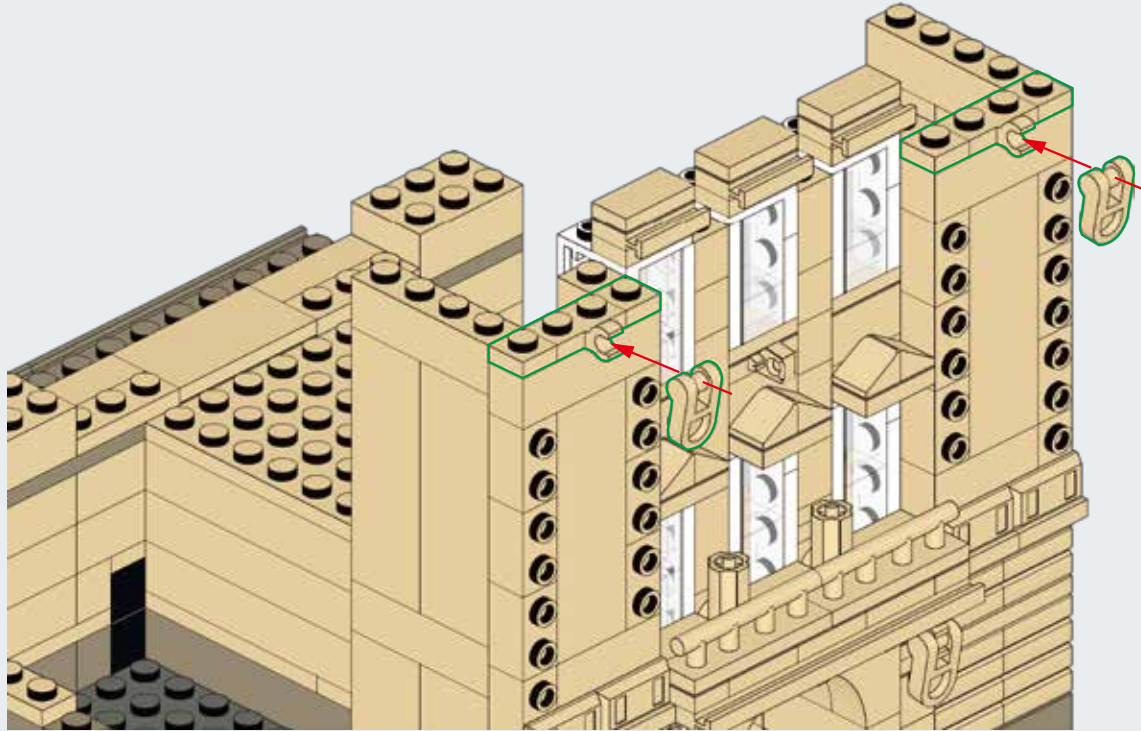

# C81

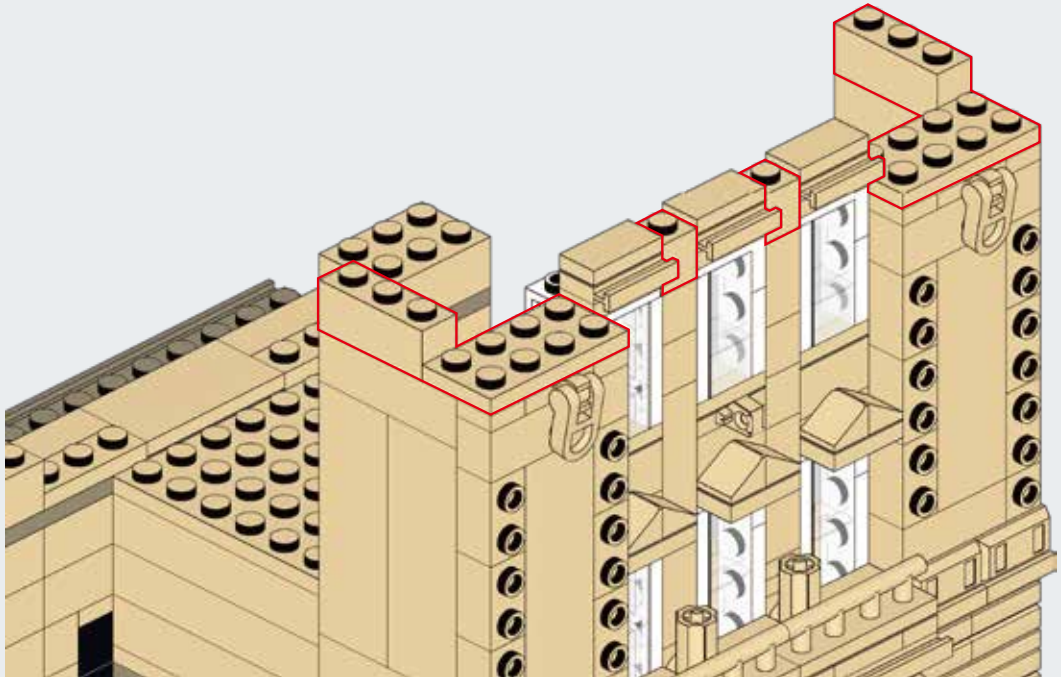

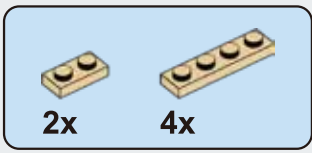

## C82

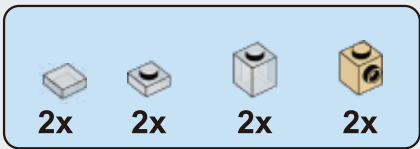
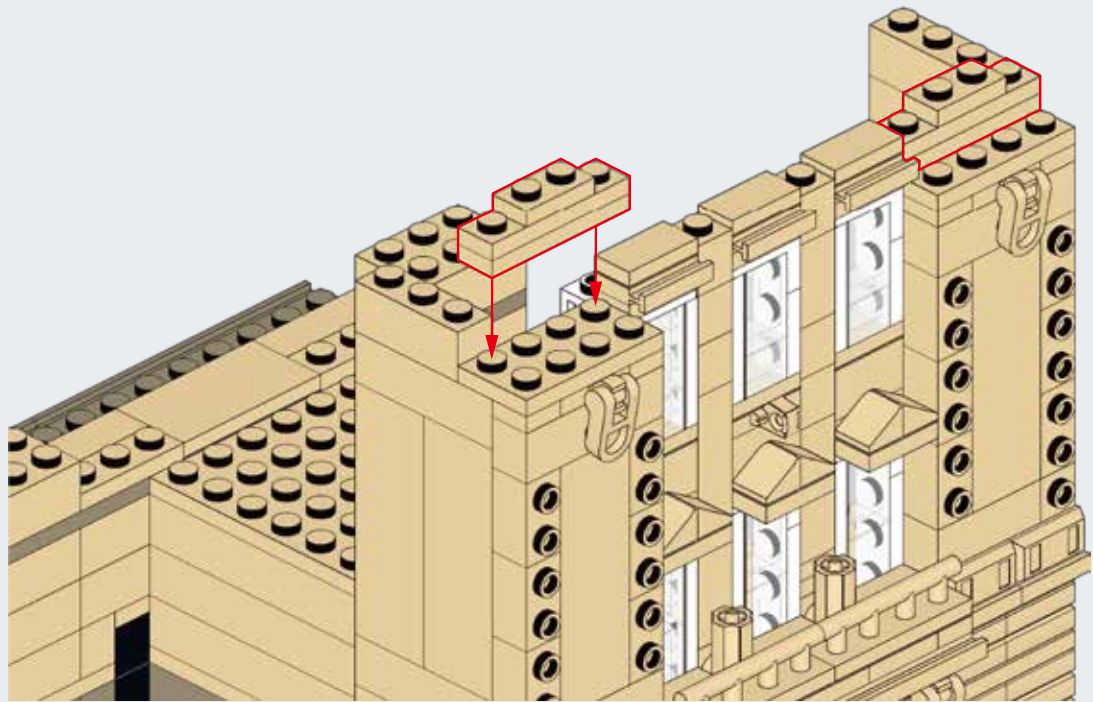
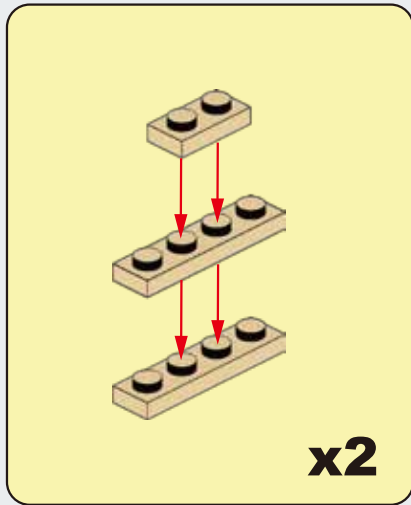

## C83

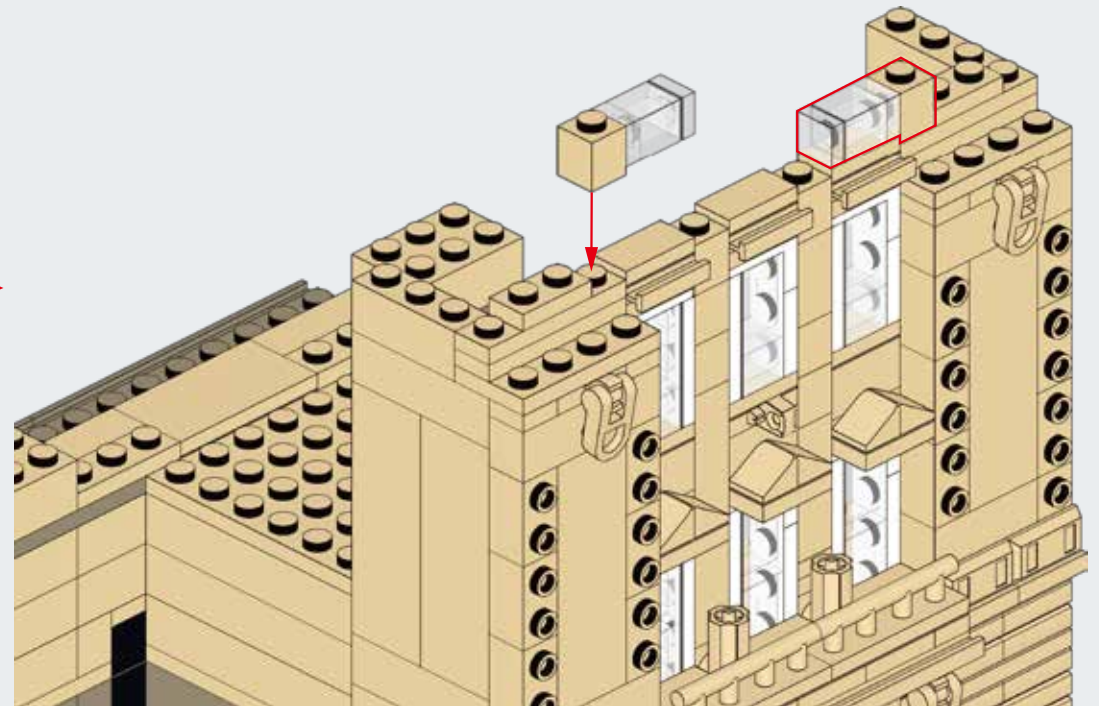
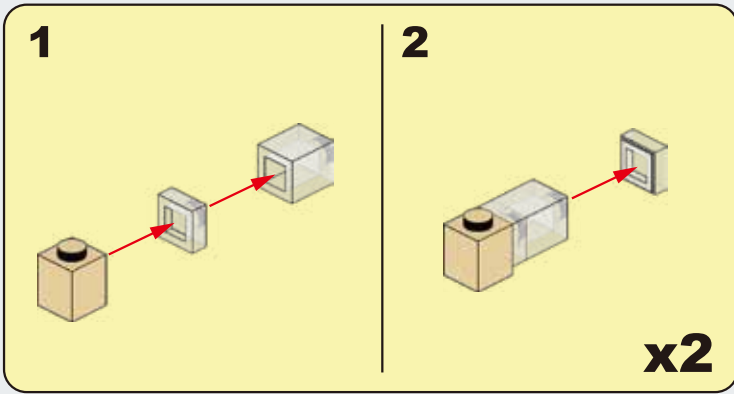

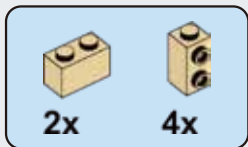

## C84

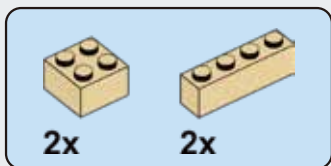
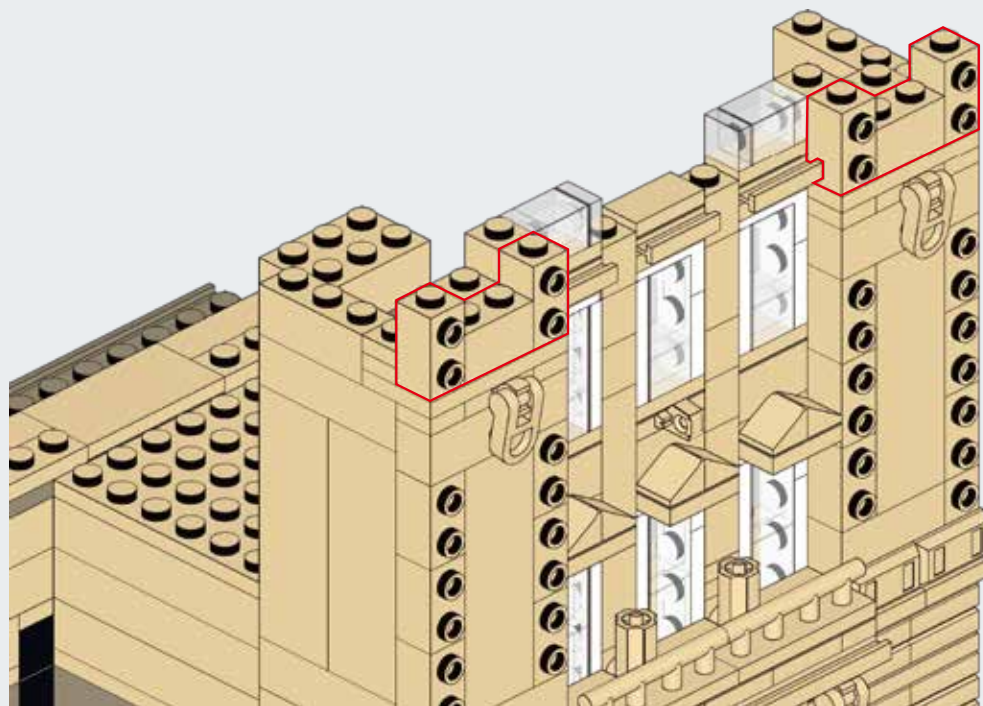

## C85

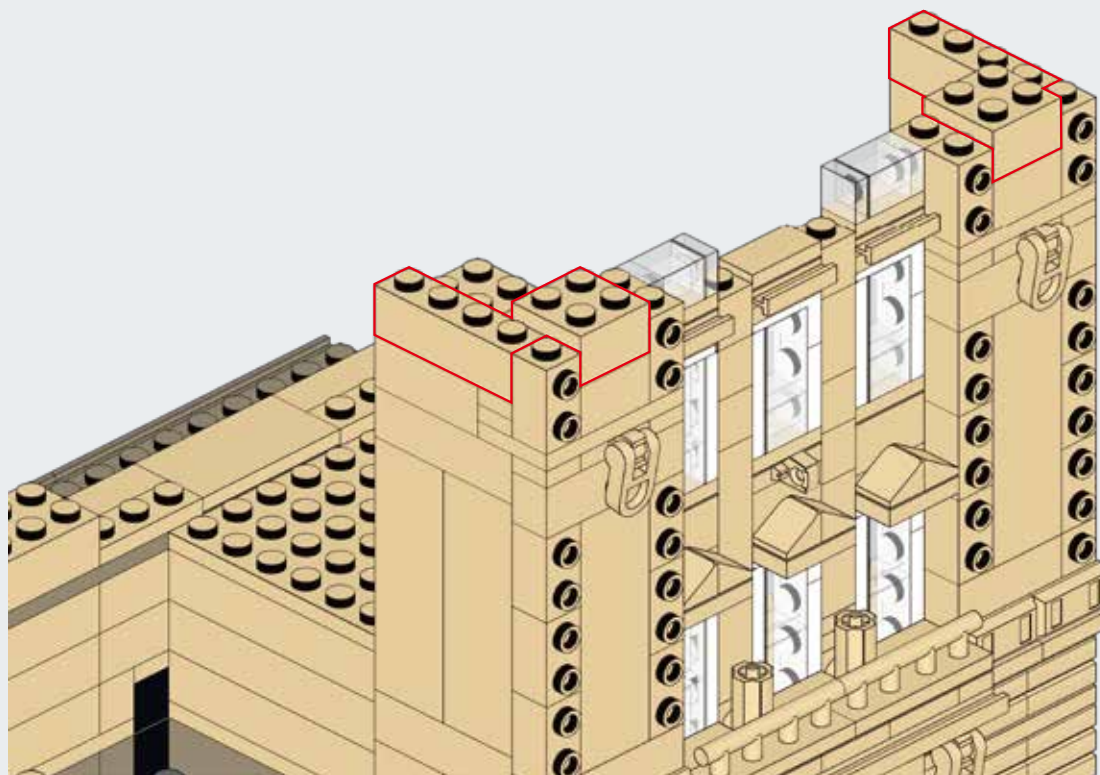

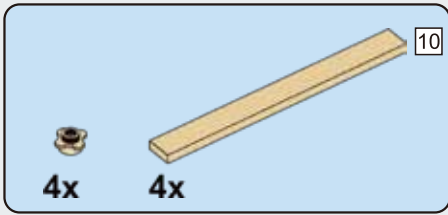

## C86

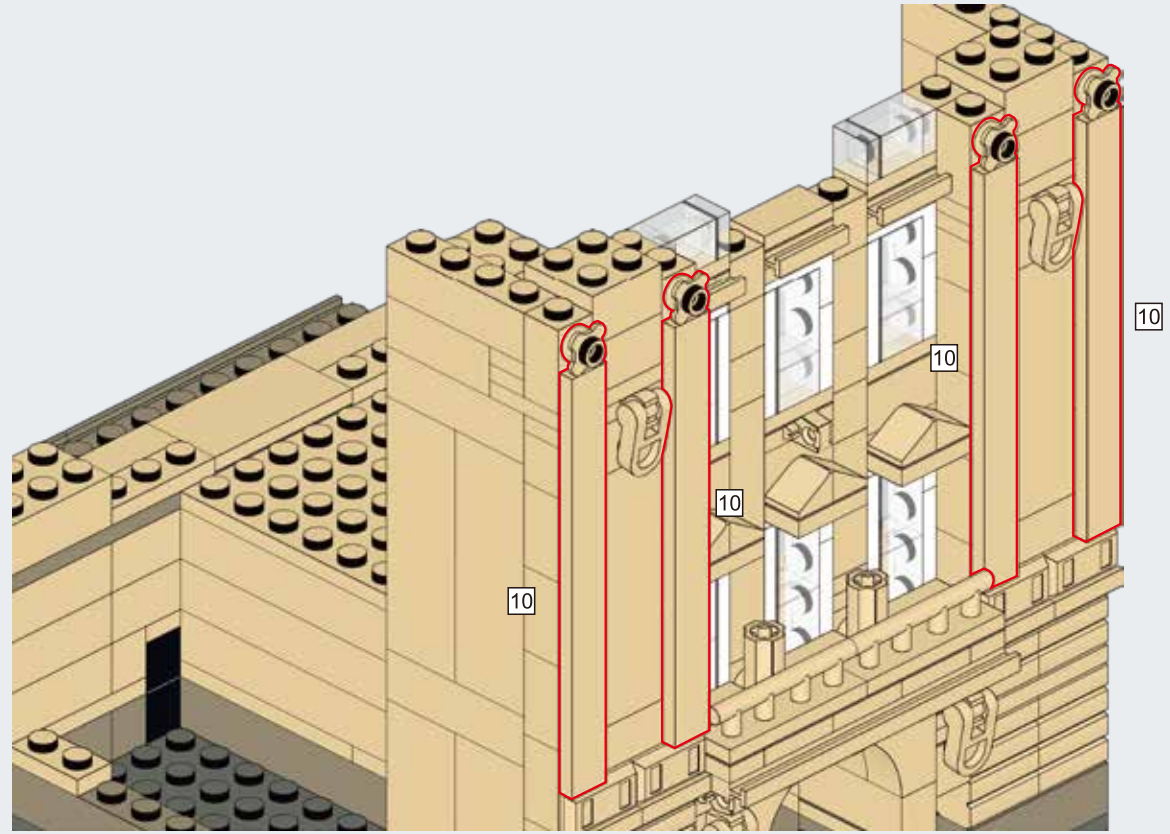

## C87

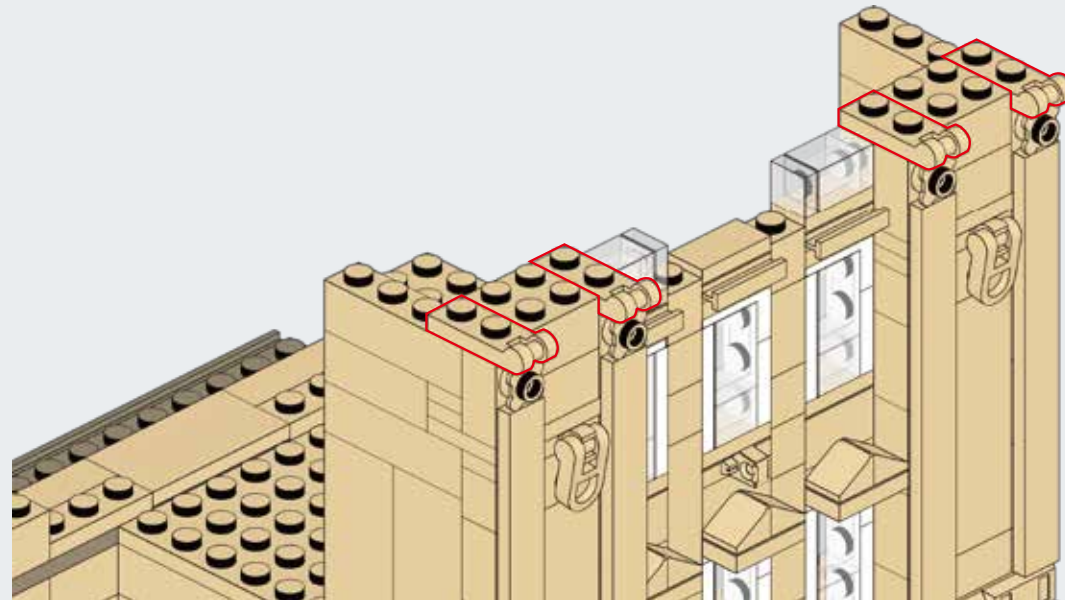

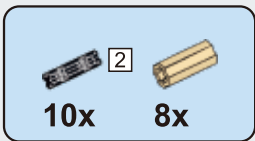

# C88

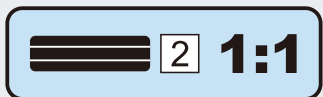
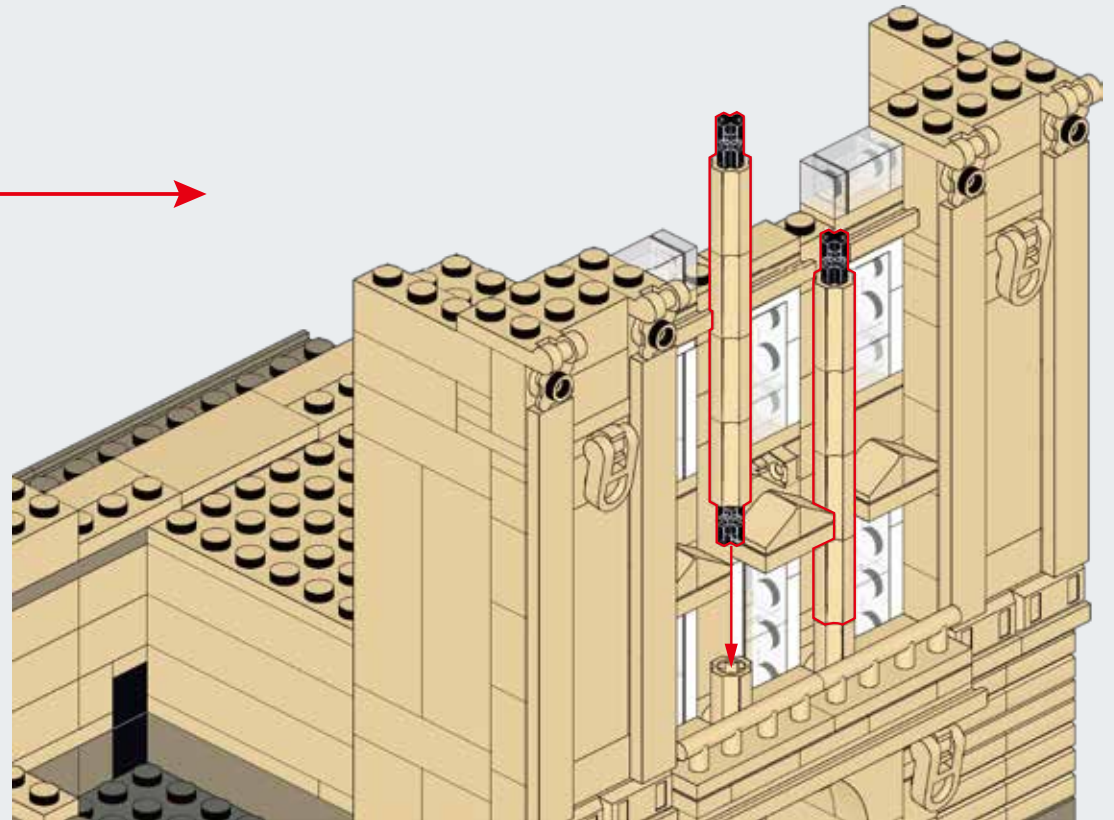
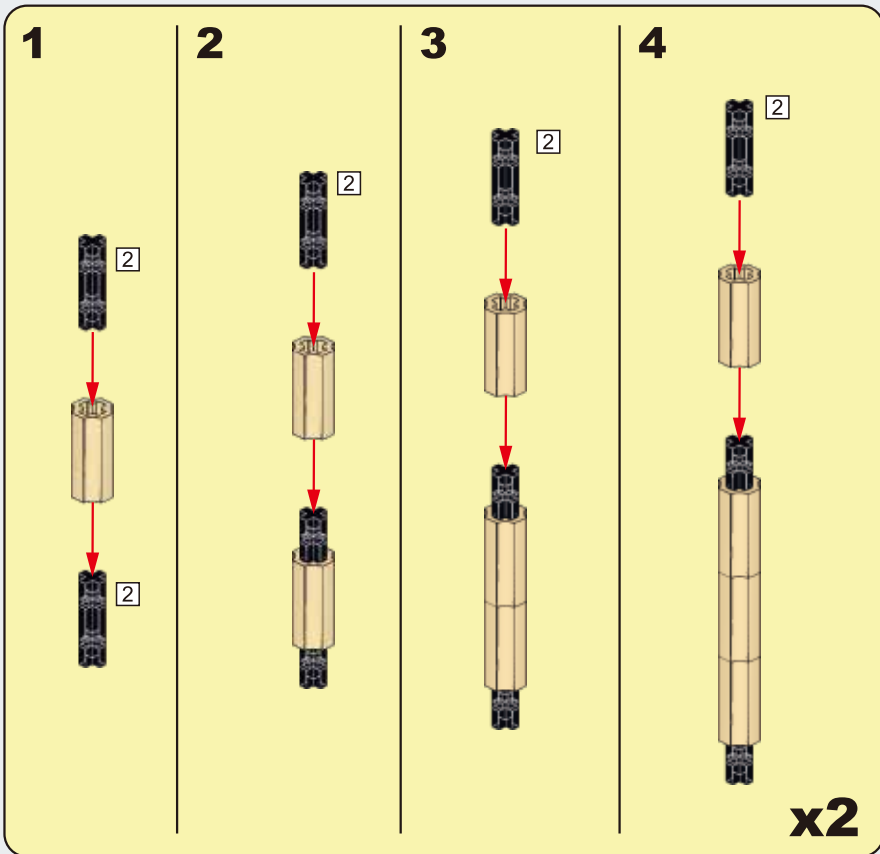

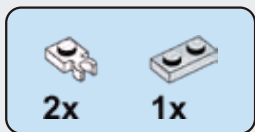

**C89**

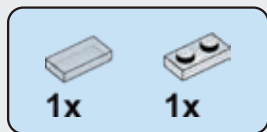
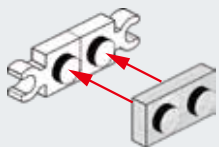

**C90**

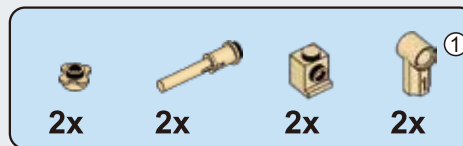
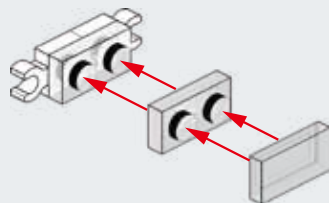

**C91**

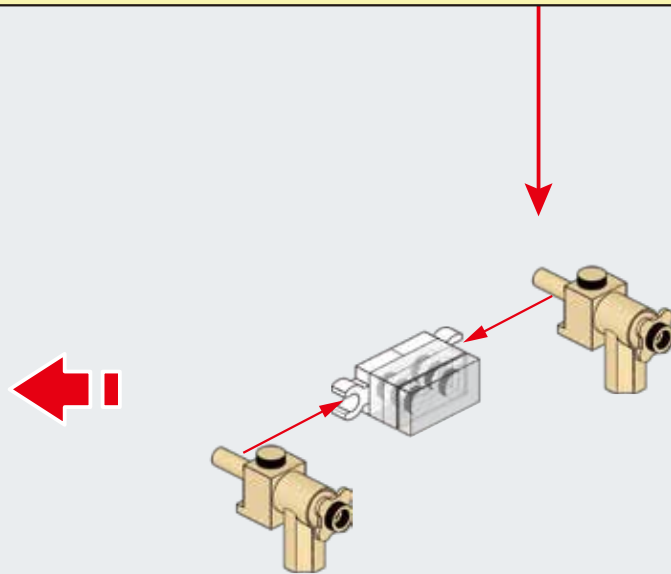
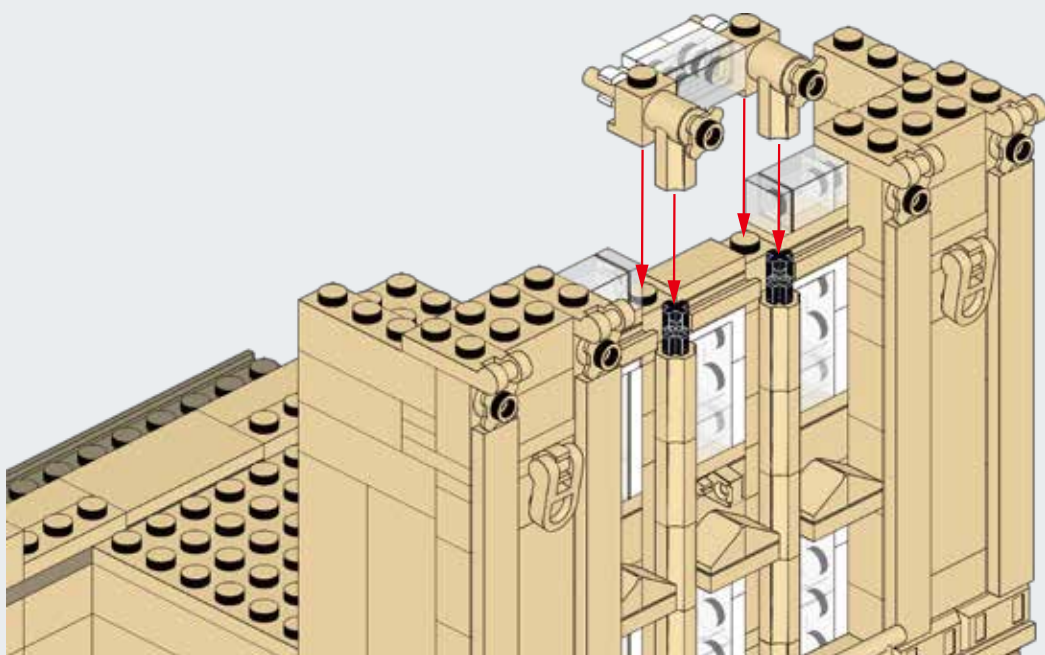
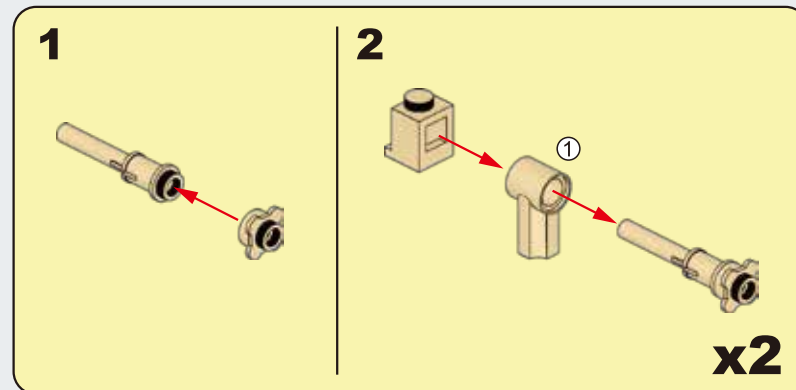

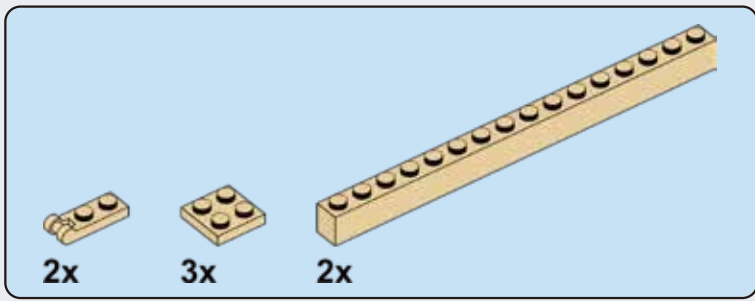

**C92**

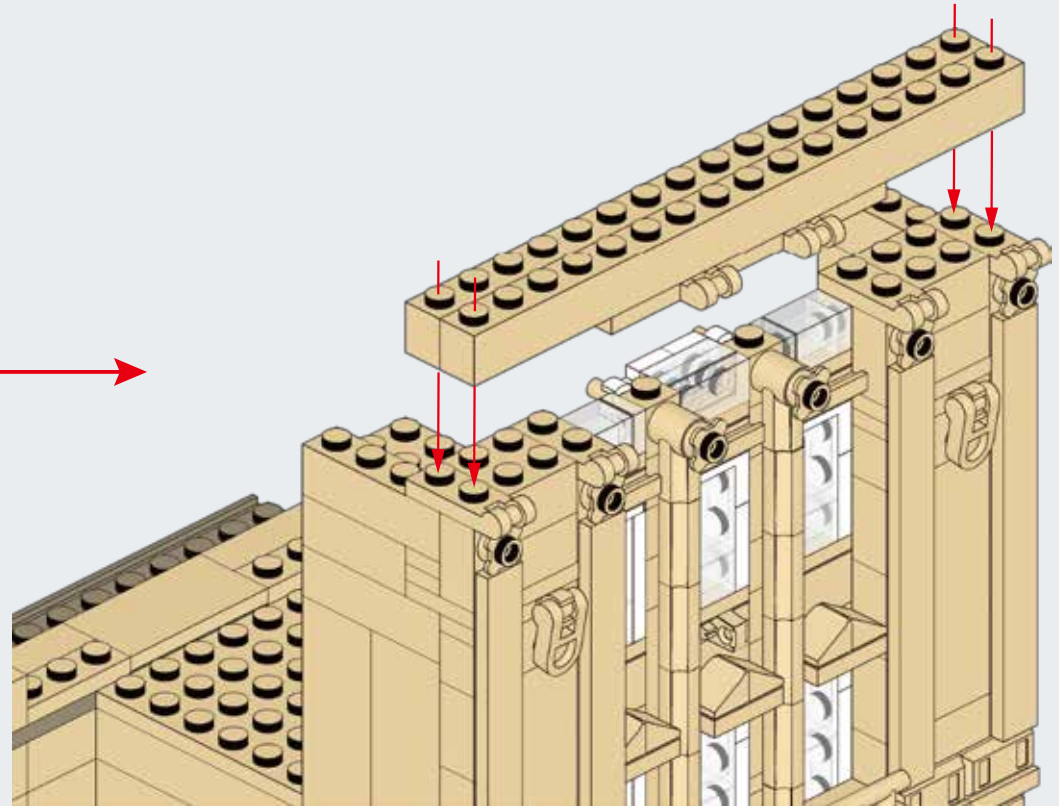
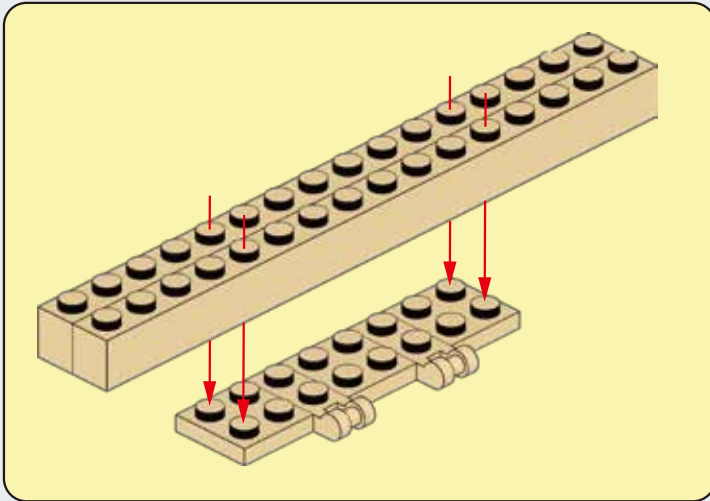

**C93**

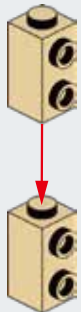

**C94**

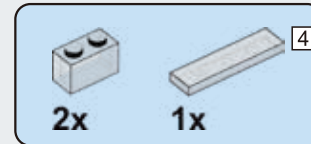
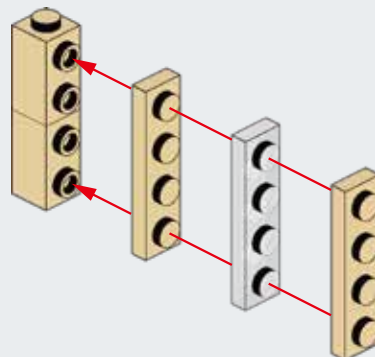

**C95**

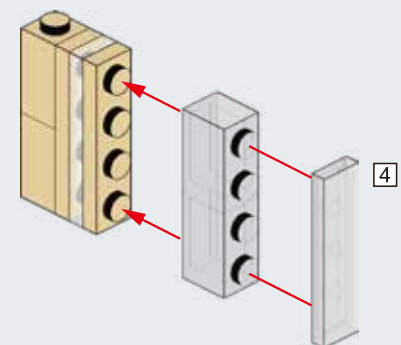



# C96

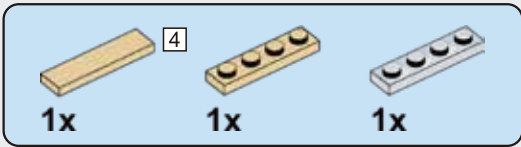
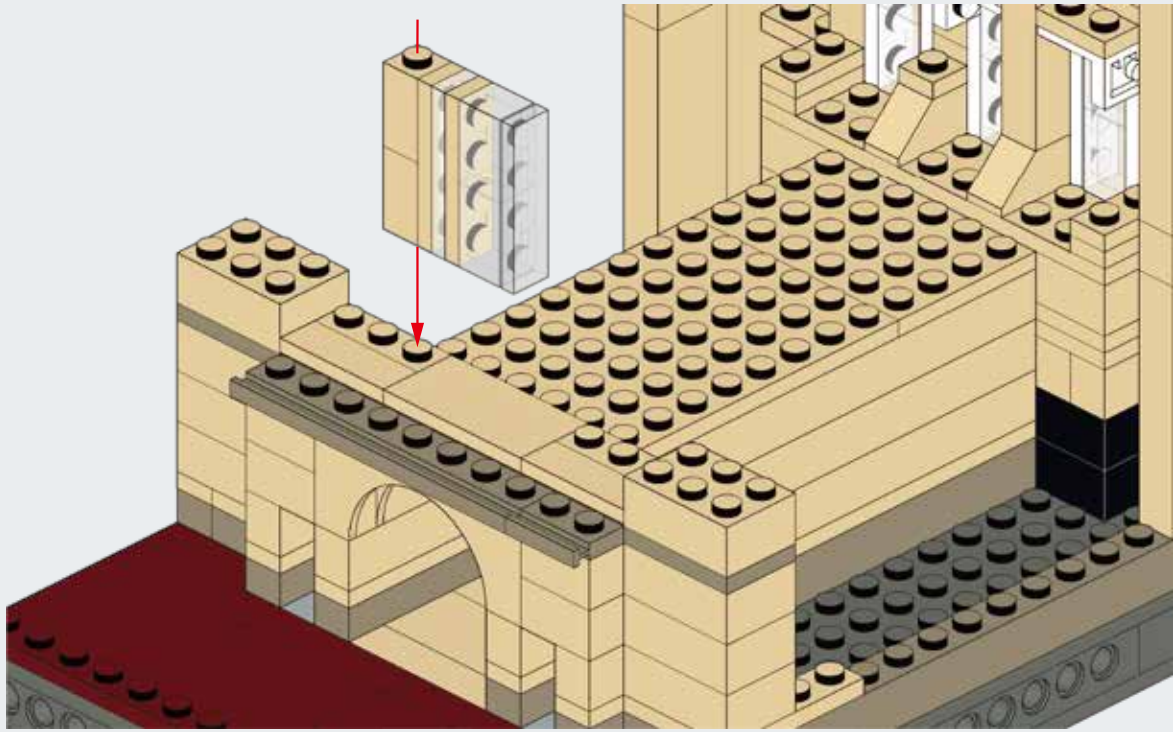

# C97

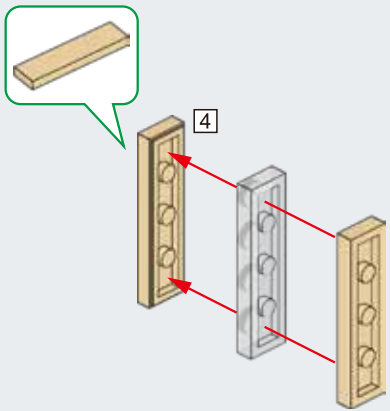

# C98

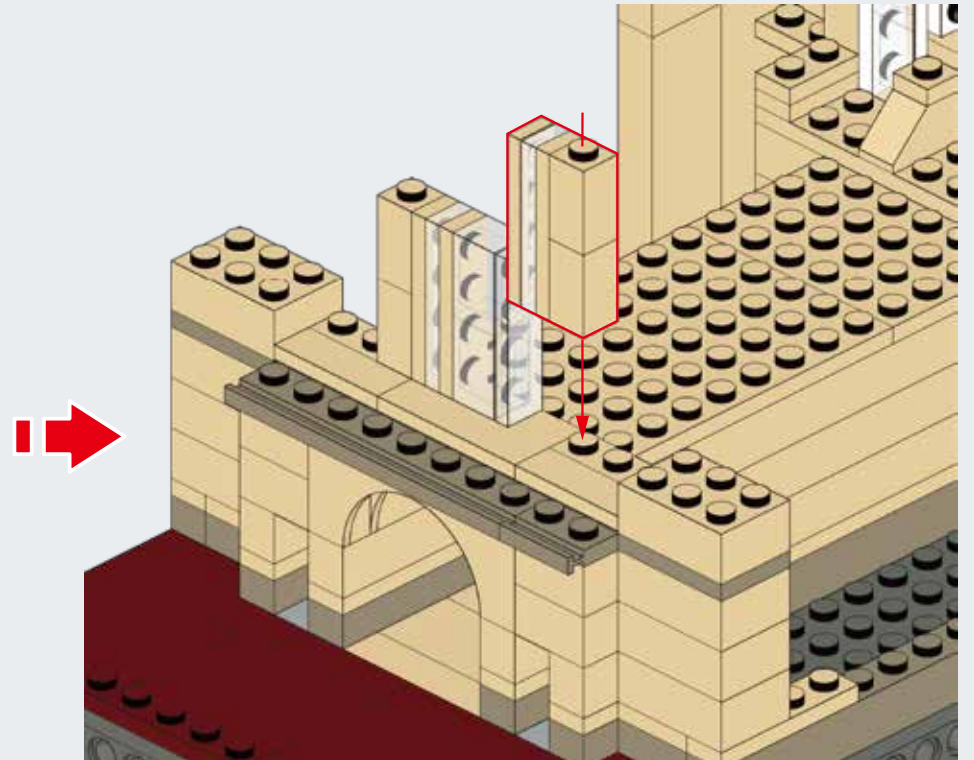
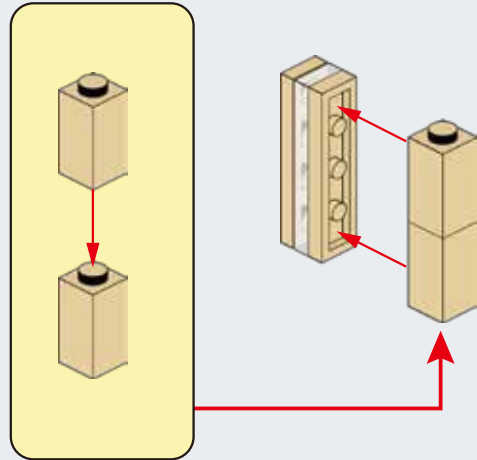

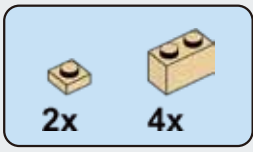

**C99**

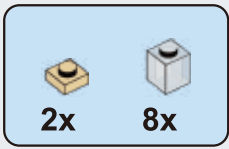
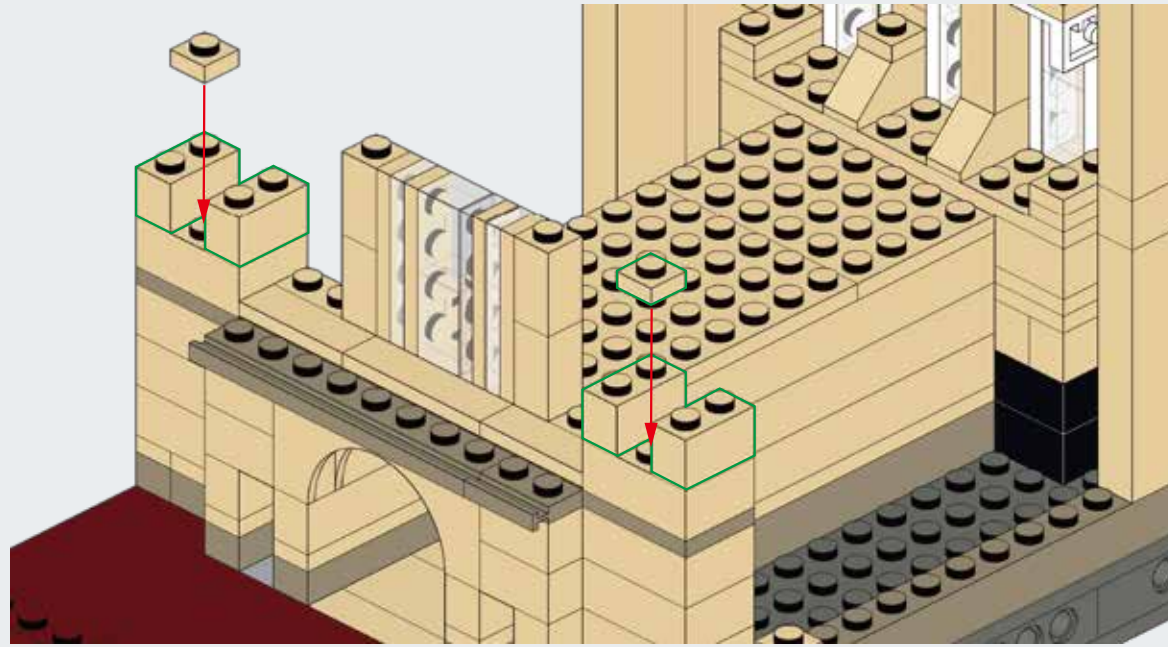

**C100**

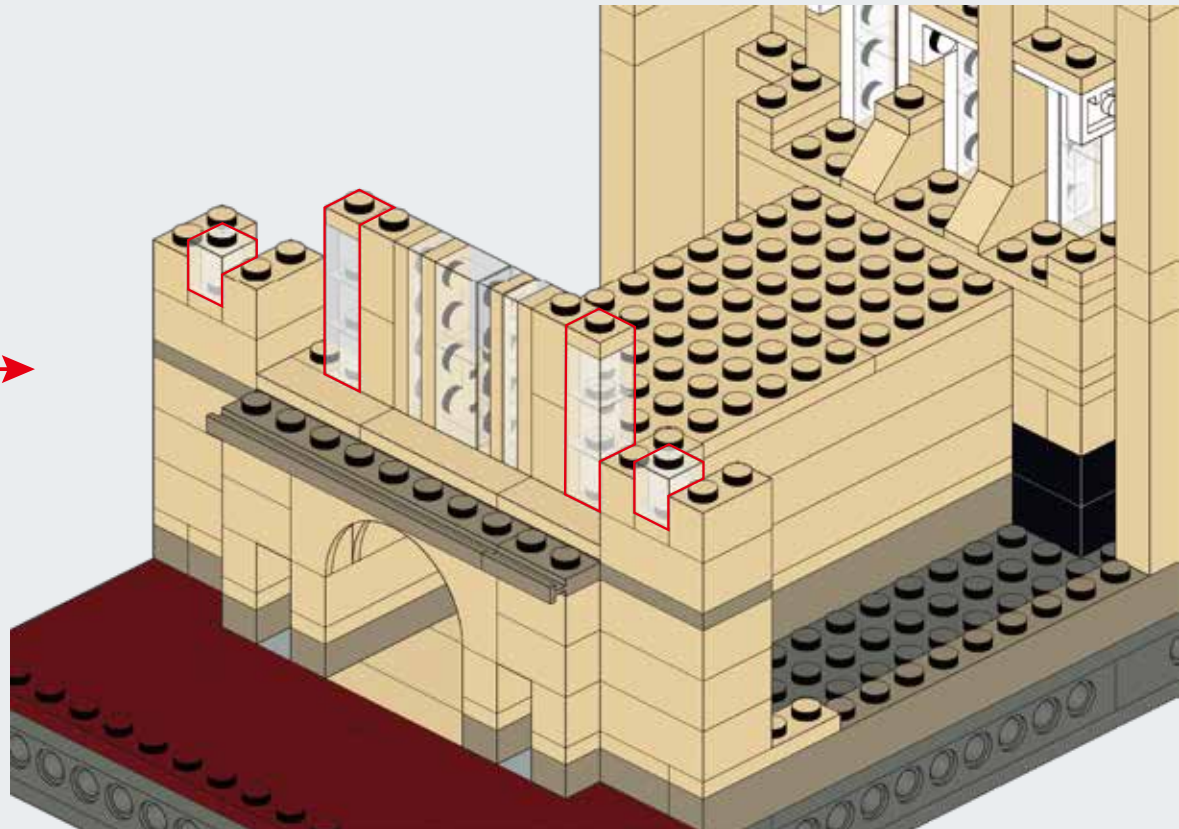
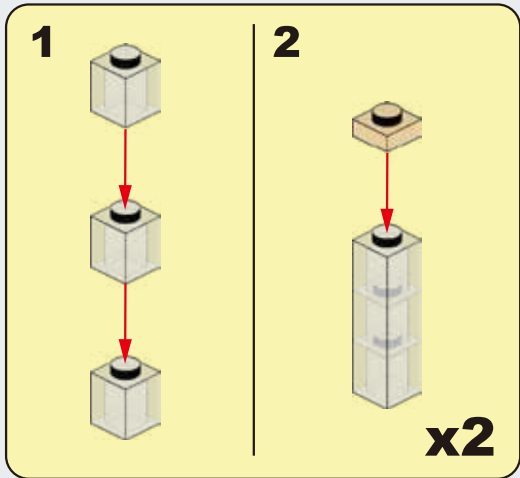



**C101**

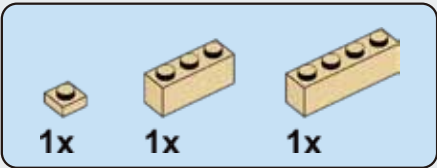
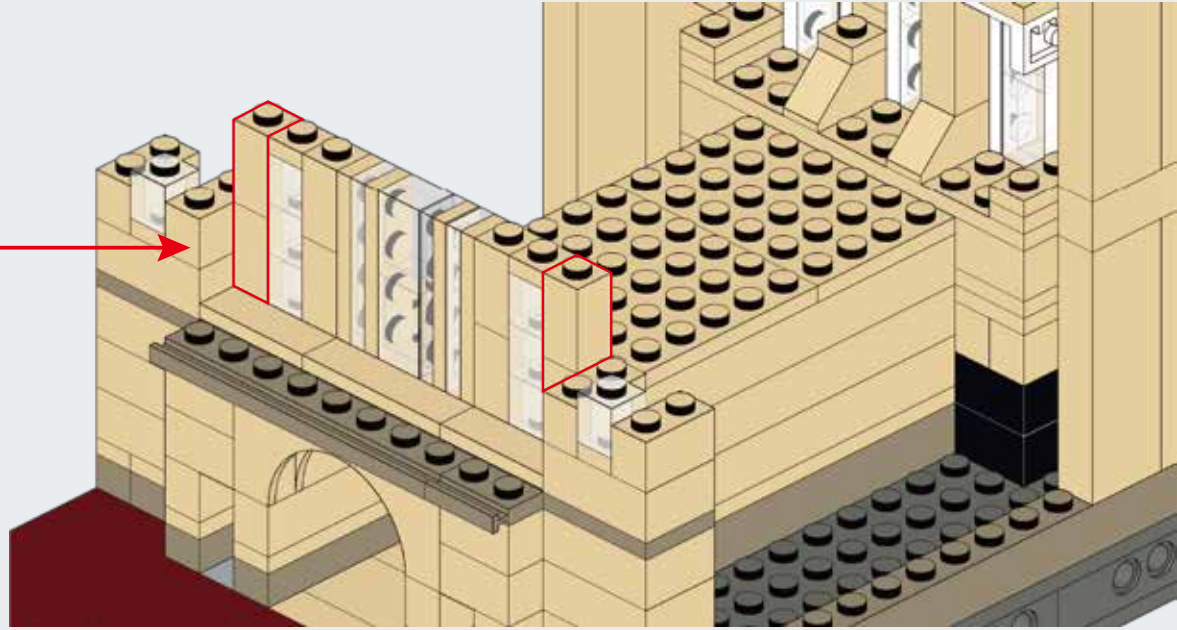
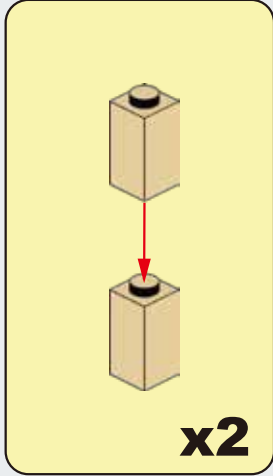

**C102**

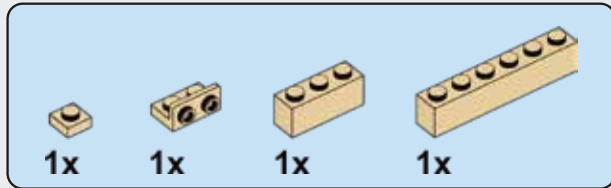
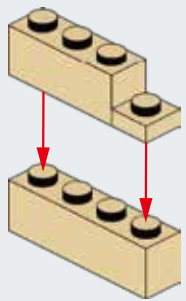

**C103**

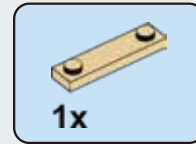
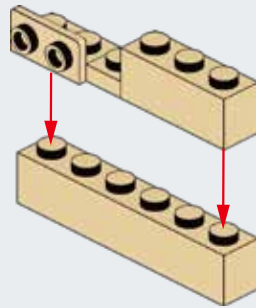

**C104**

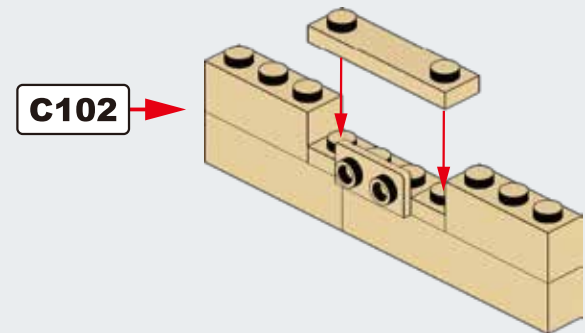

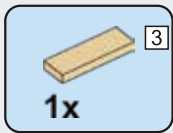

## C105

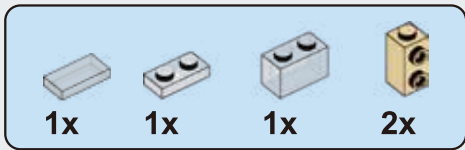
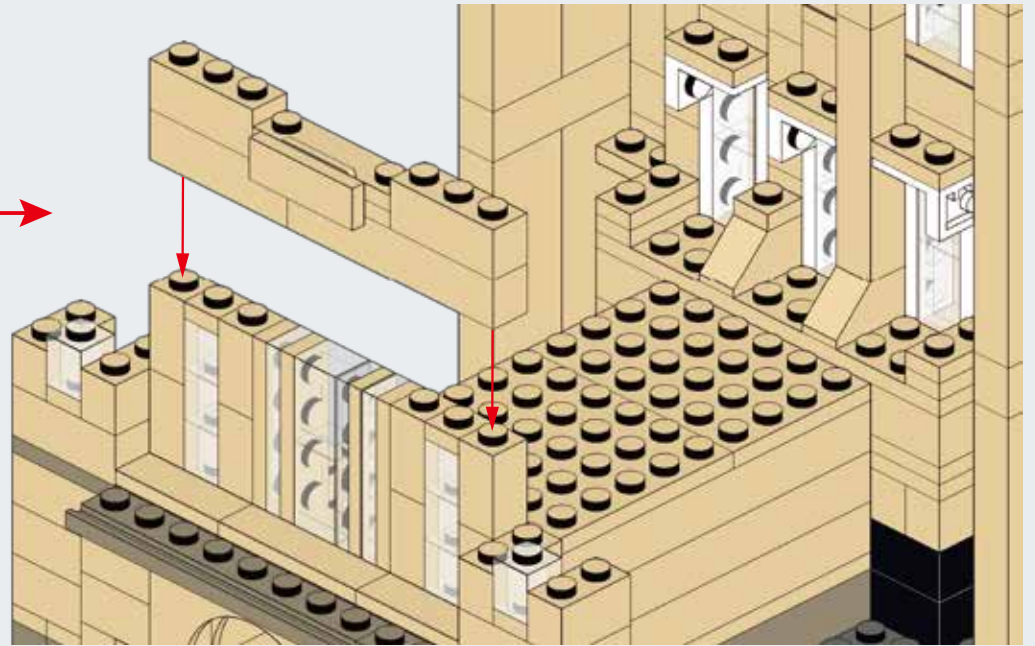
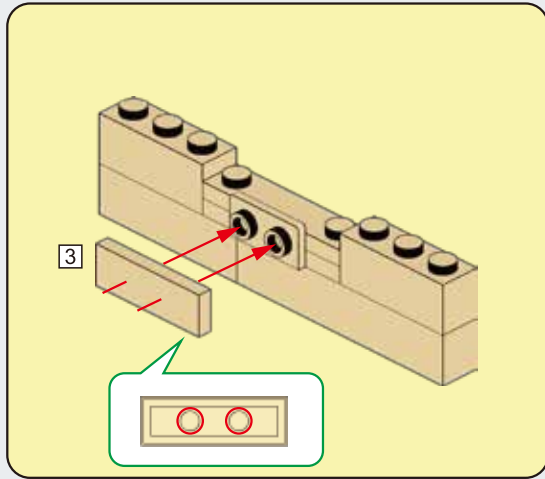

## C106

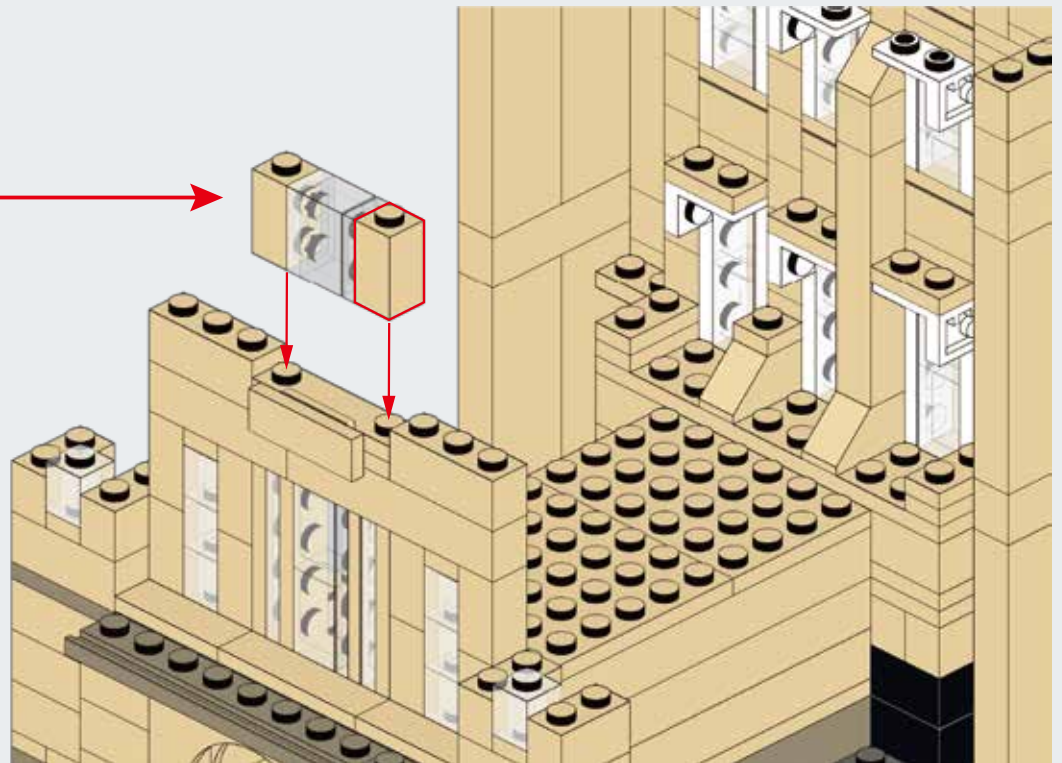
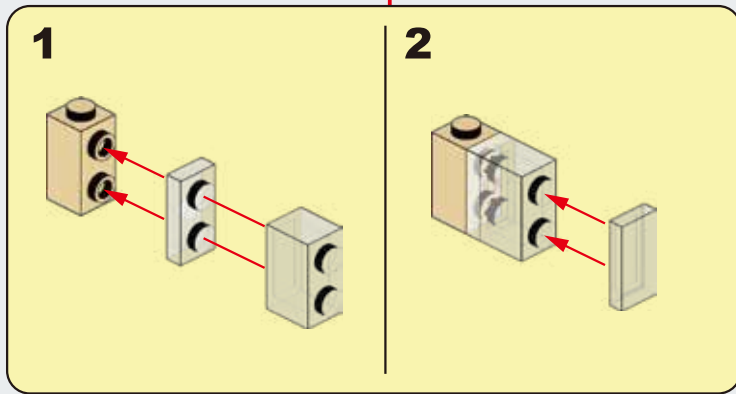

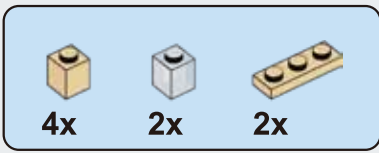

### C107

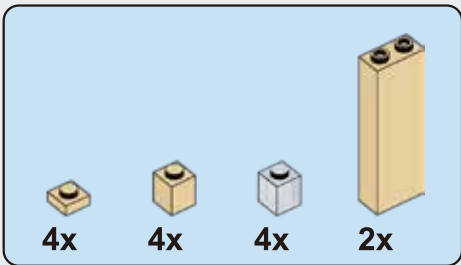
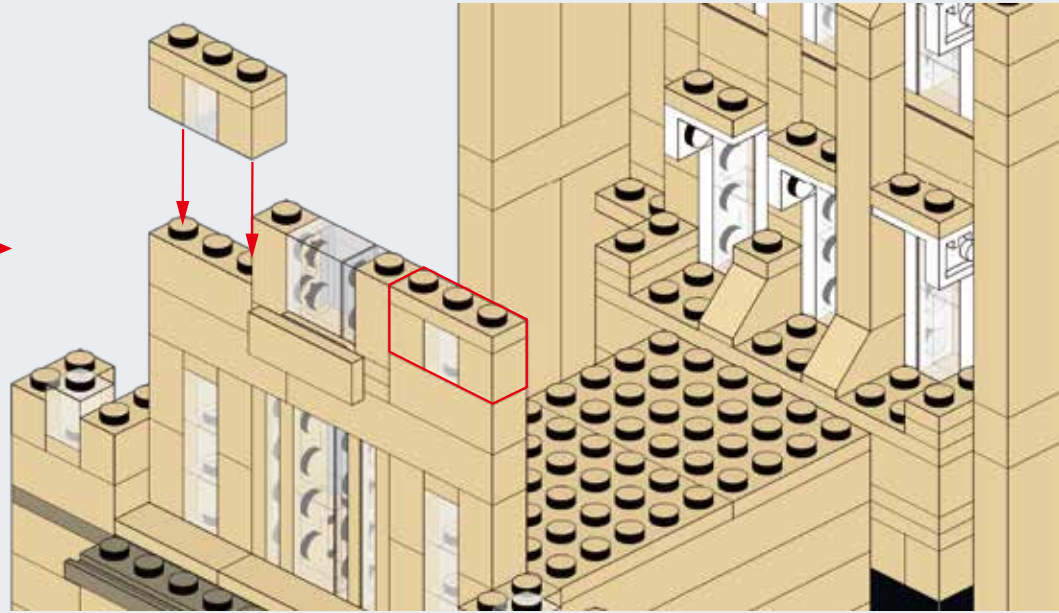
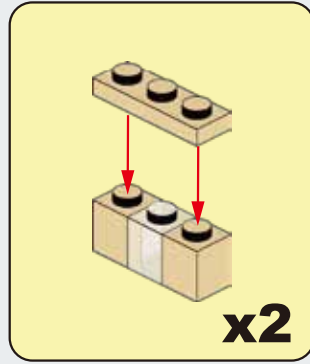

### C108

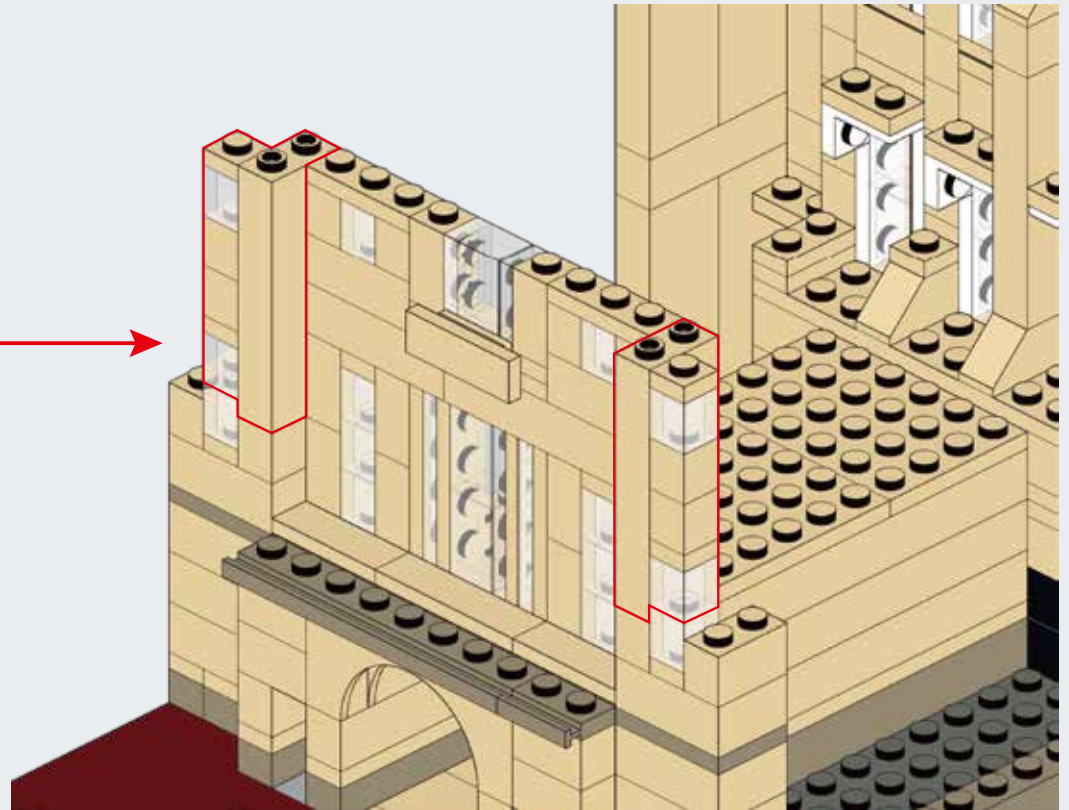
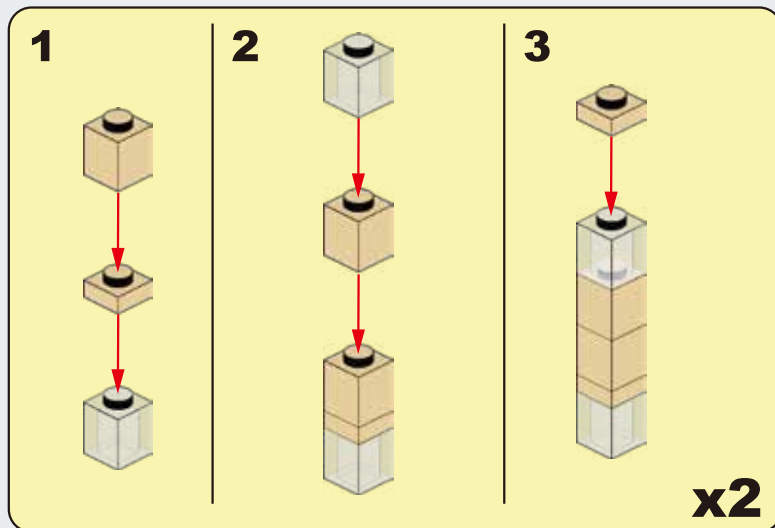

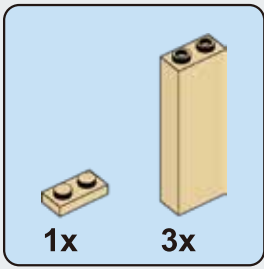

# C109

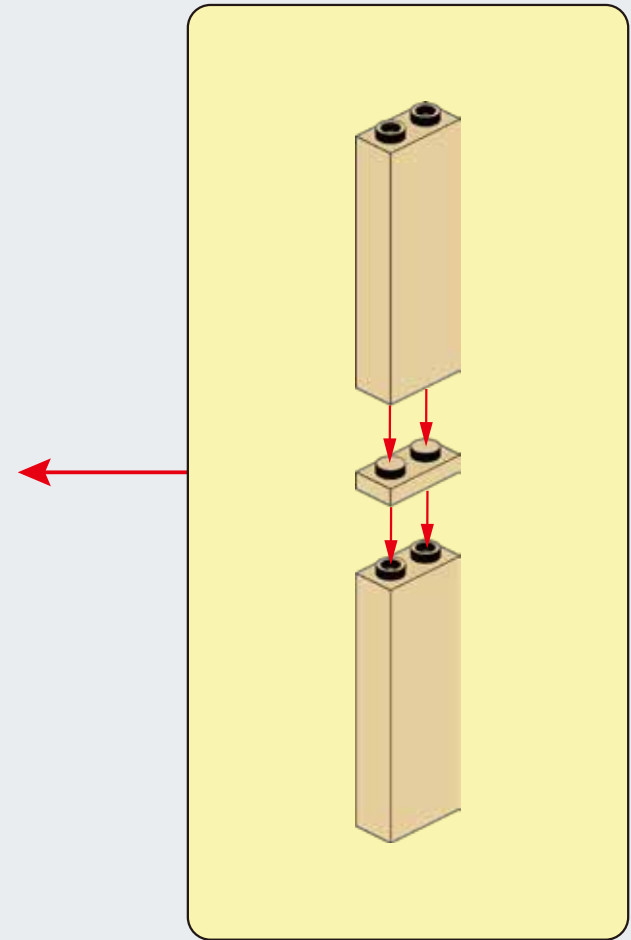
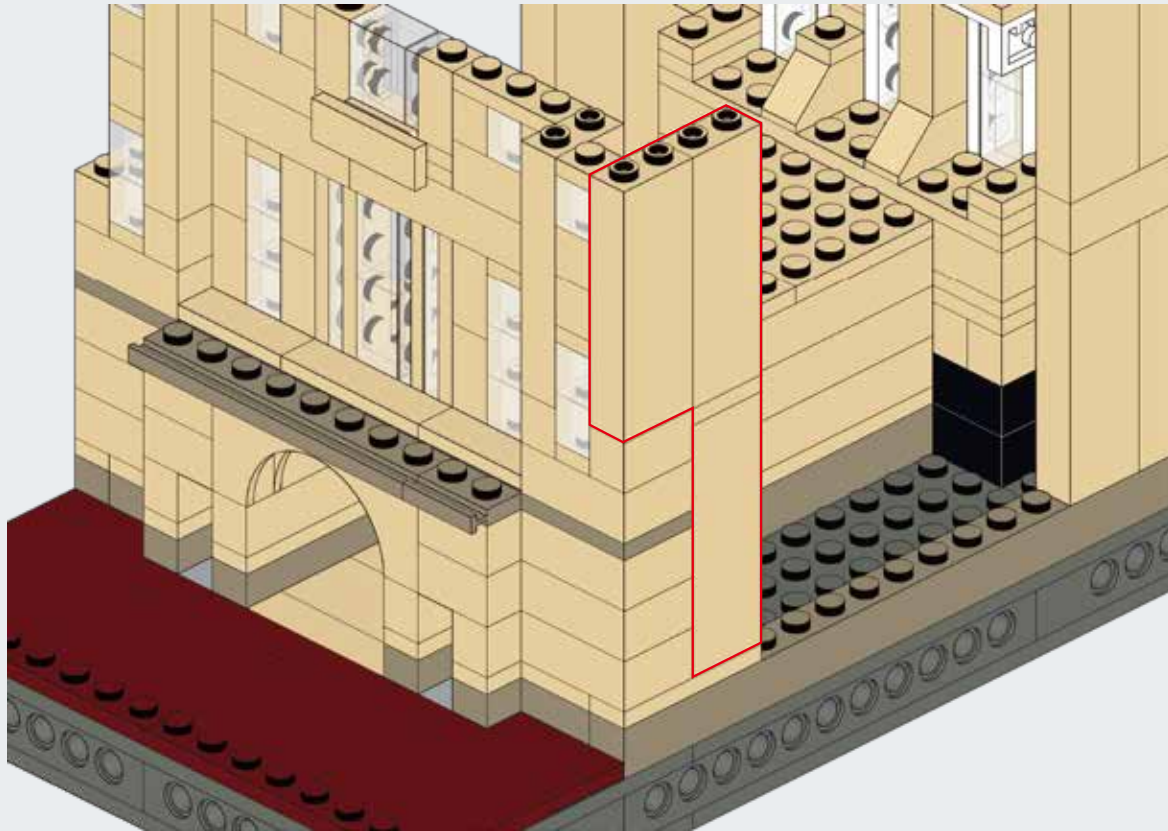

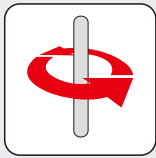
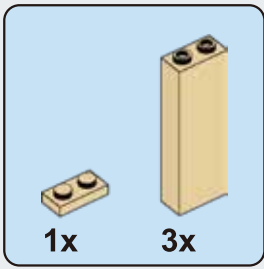

# C110

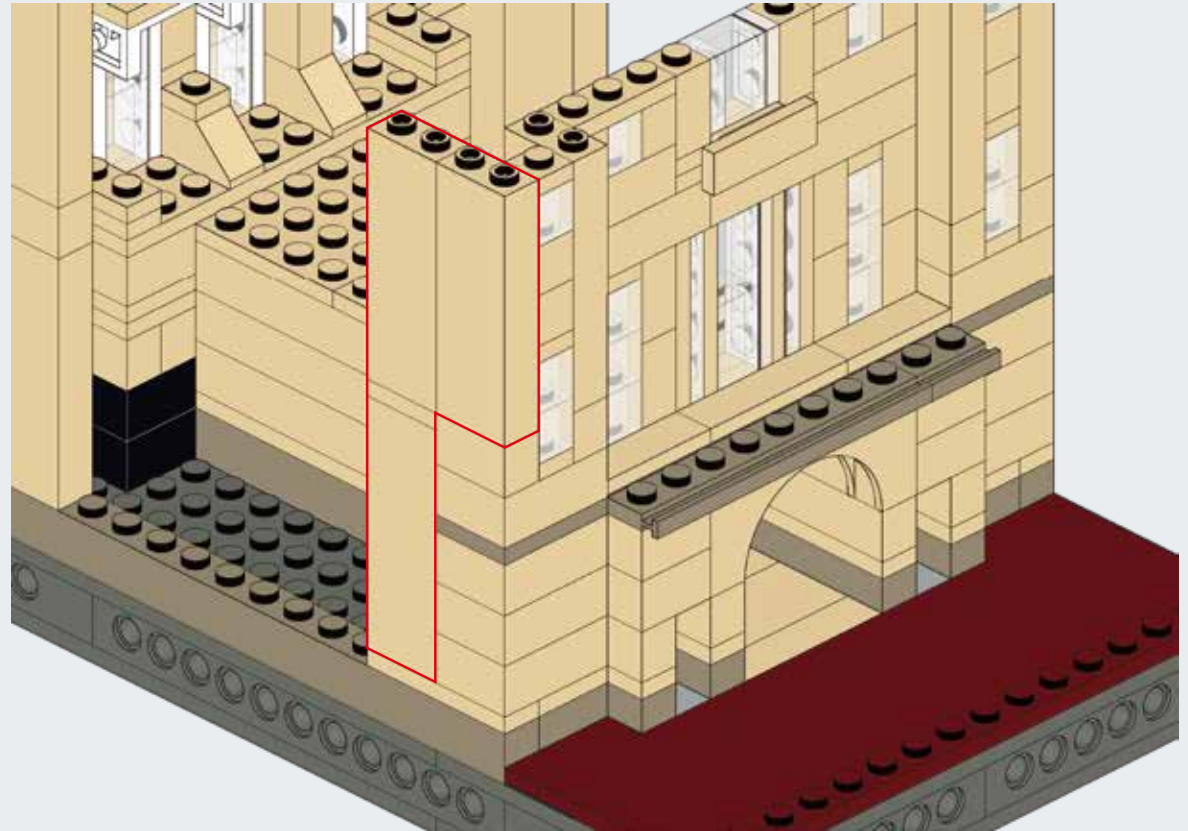
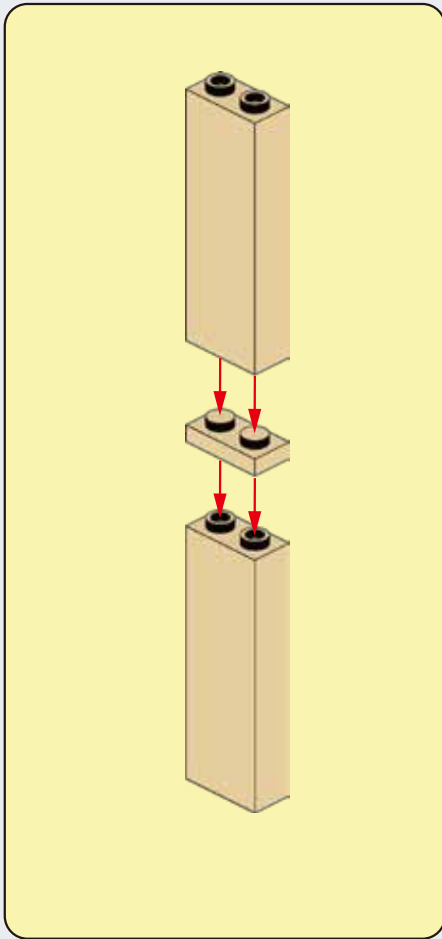

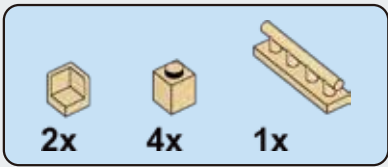

# C111

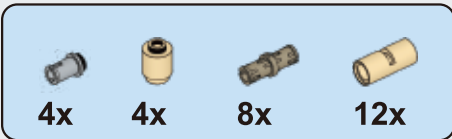
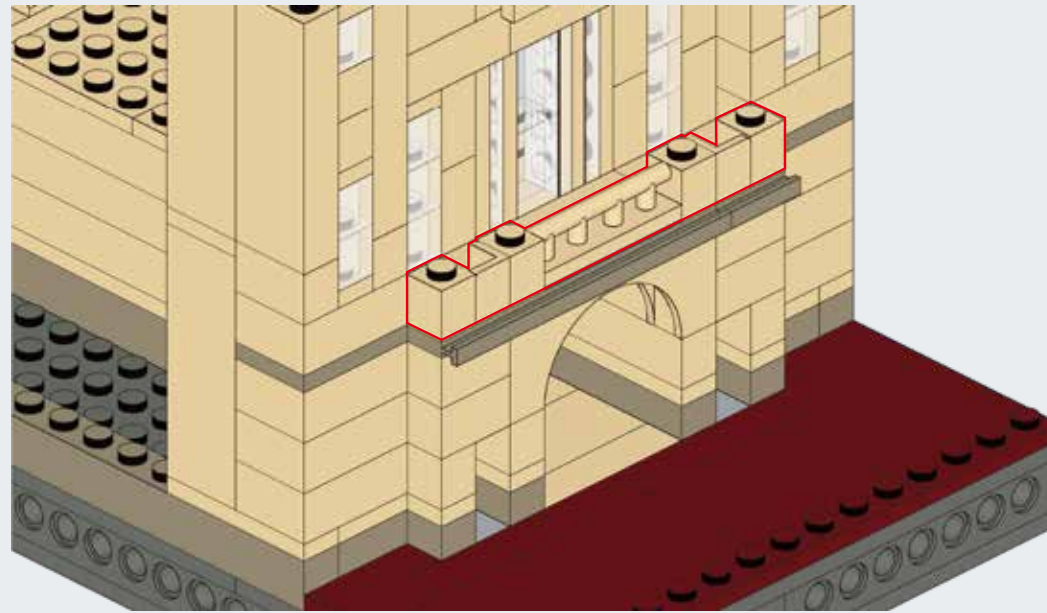

# C112

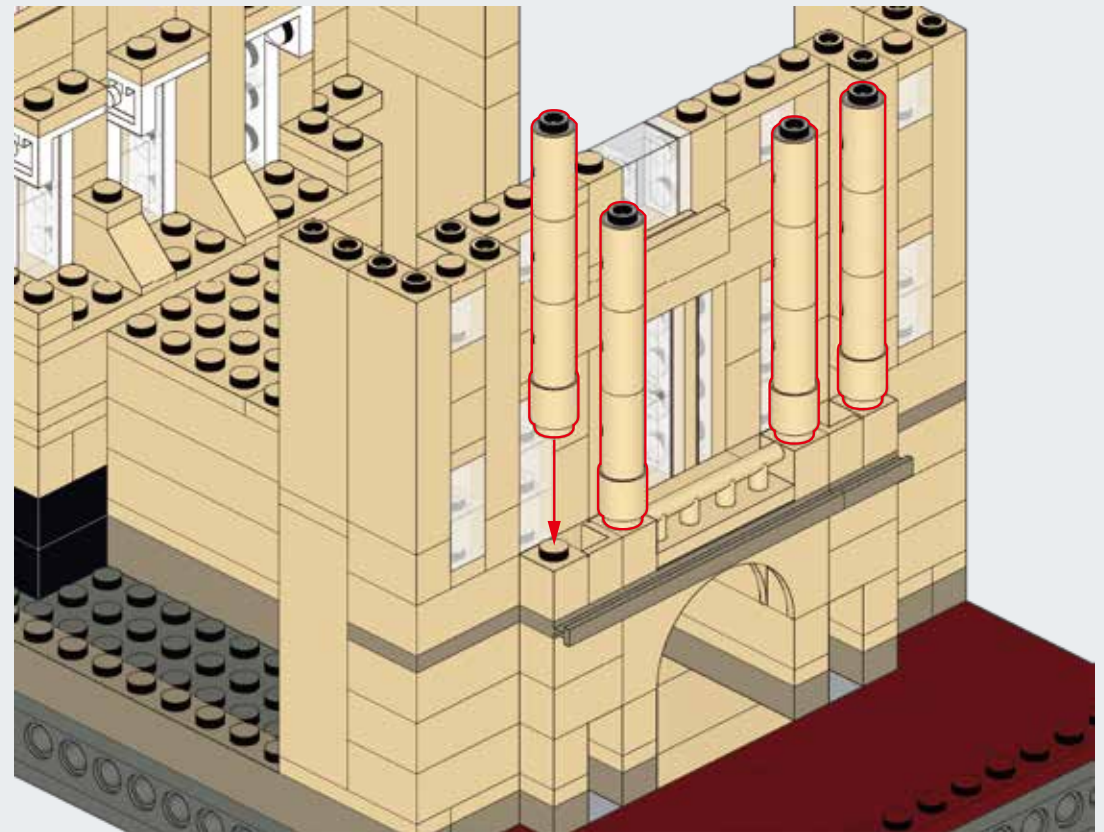
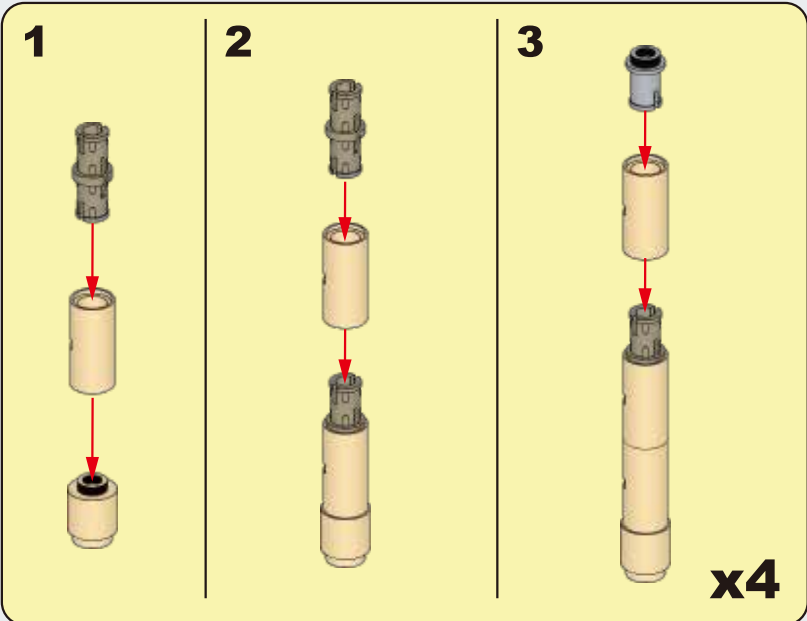



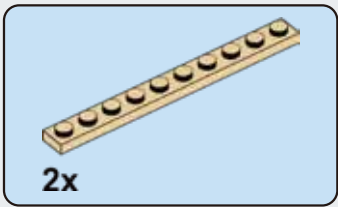

**C113**

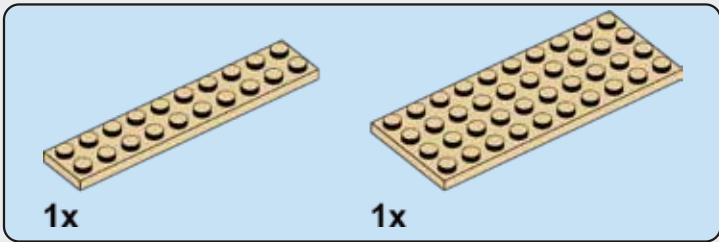
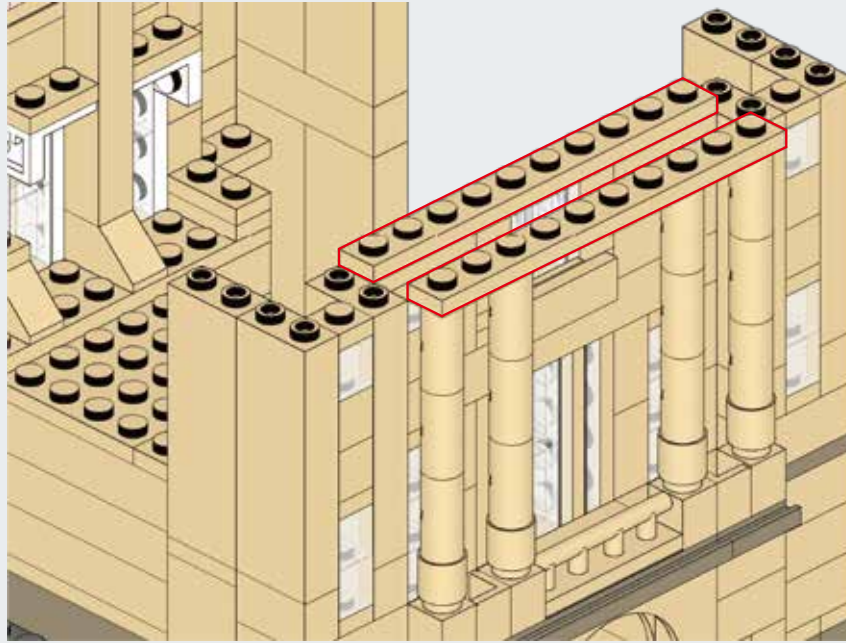

**C114**

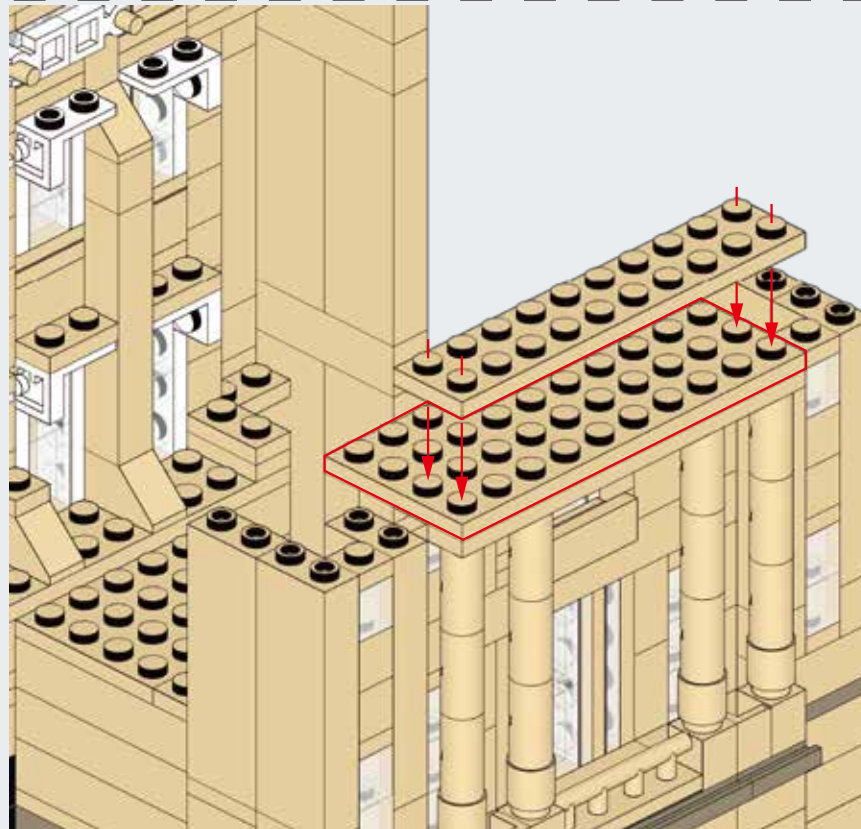

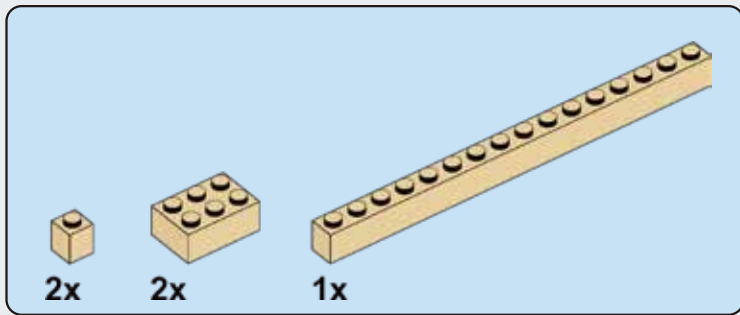

## C115

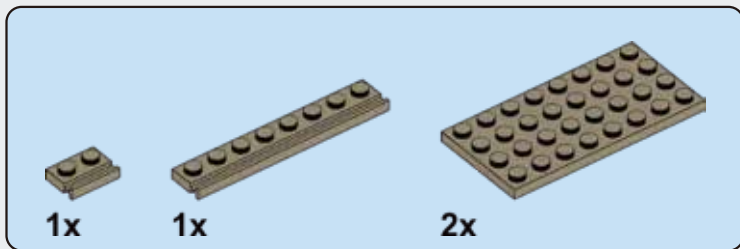
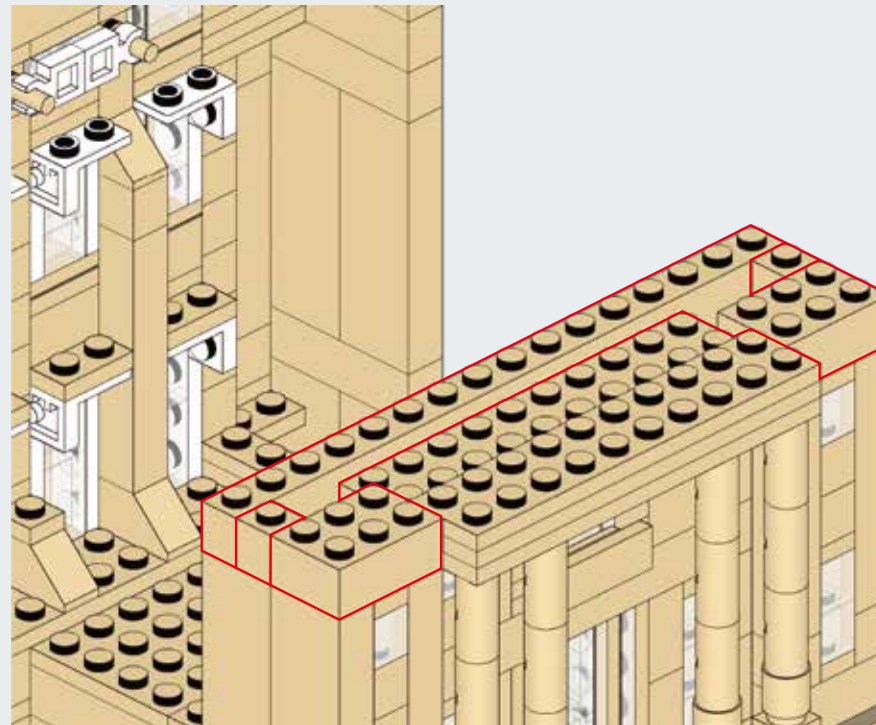

## C116

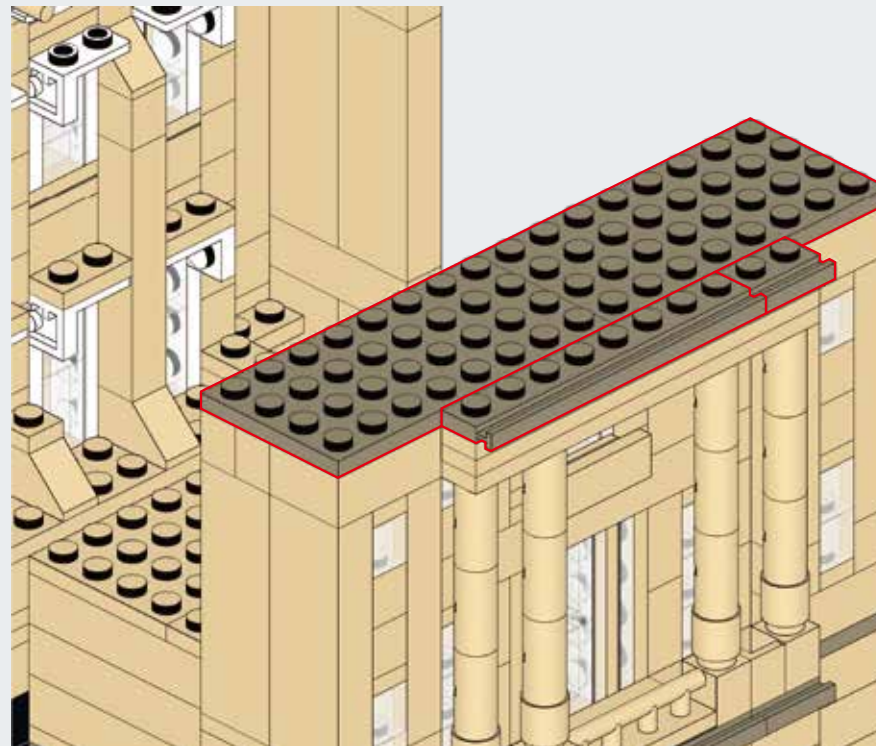

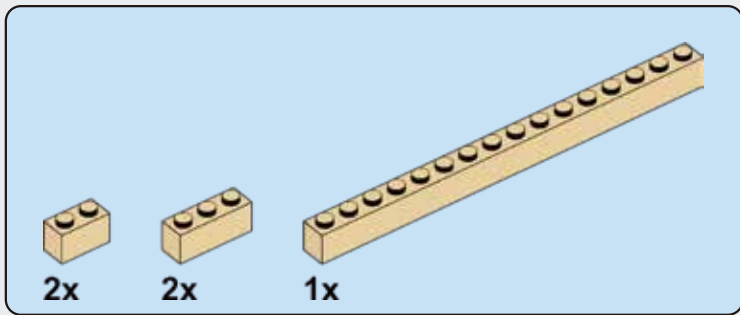

**C117**

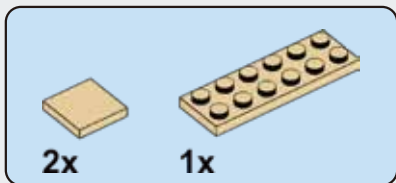
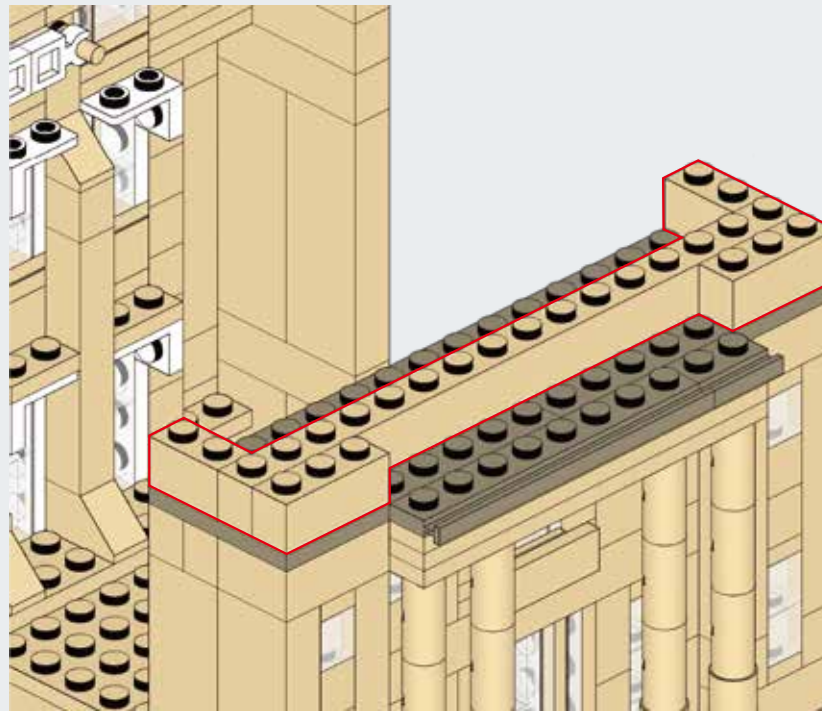

**C118**

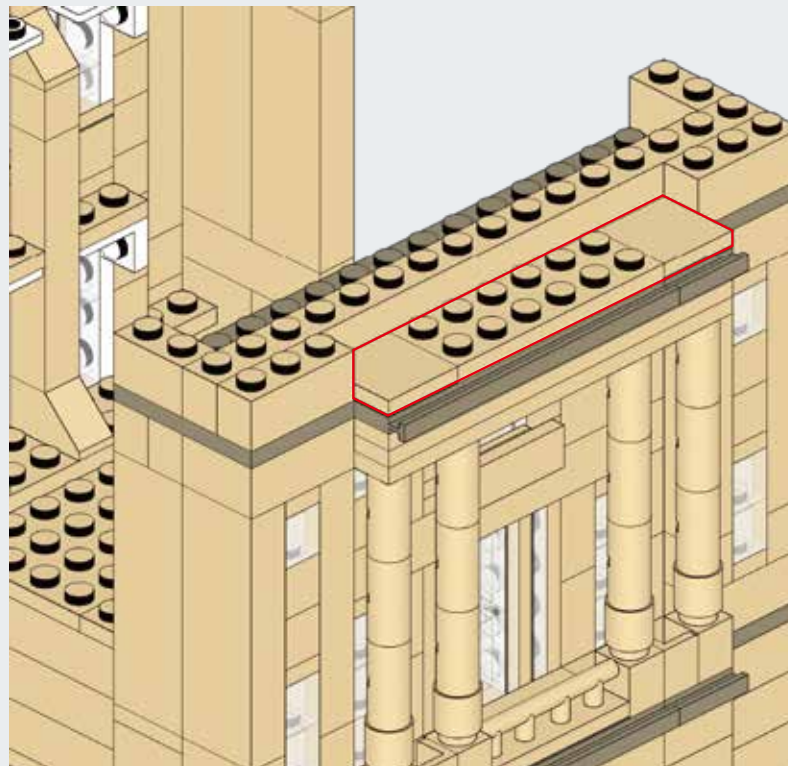

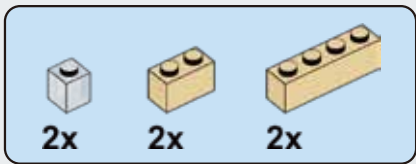

# C119

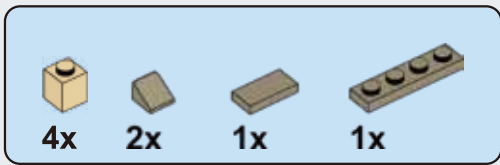
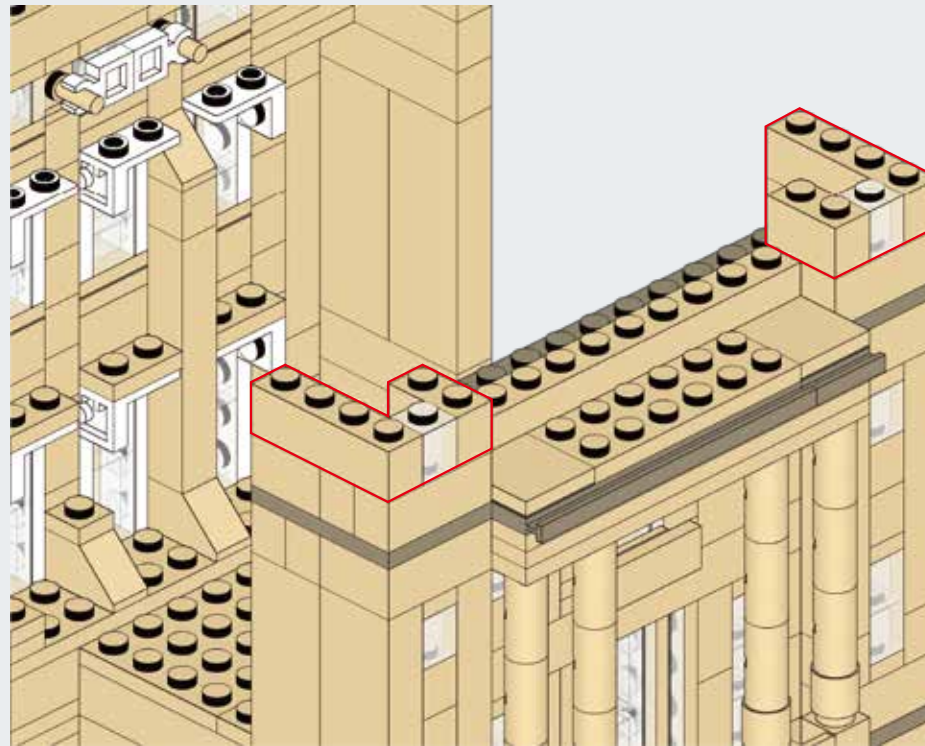

# C120

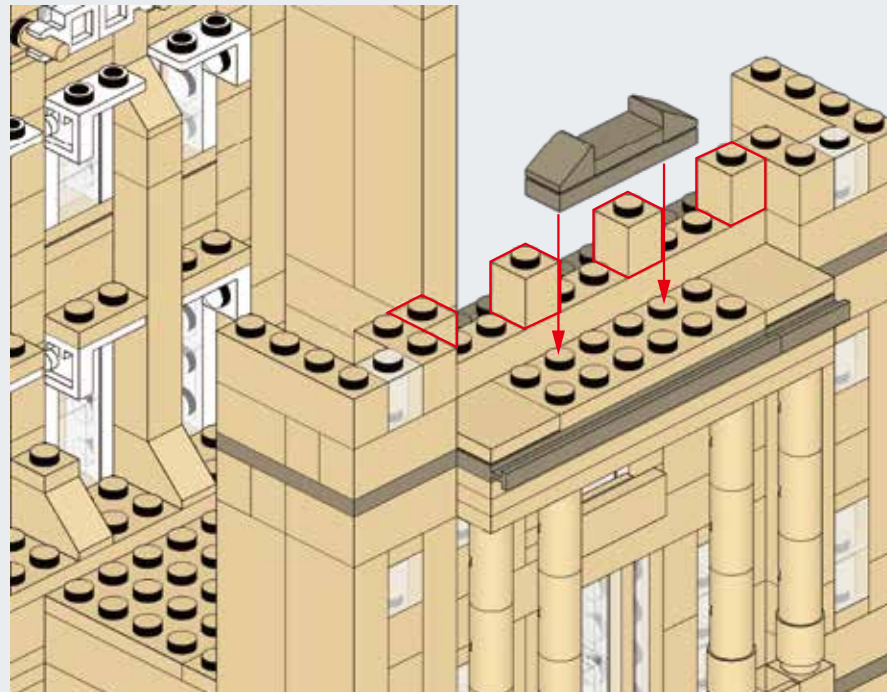
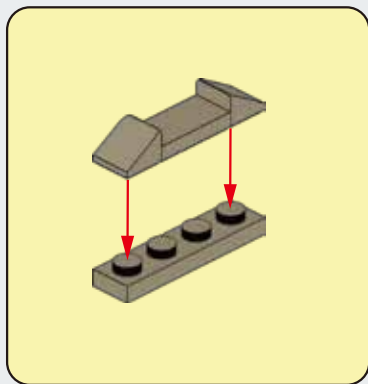



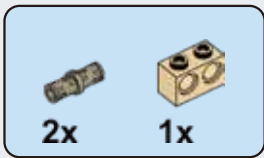

## C124

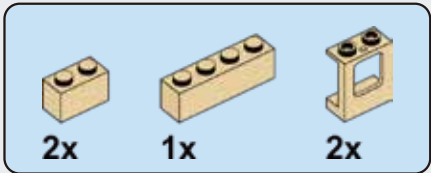
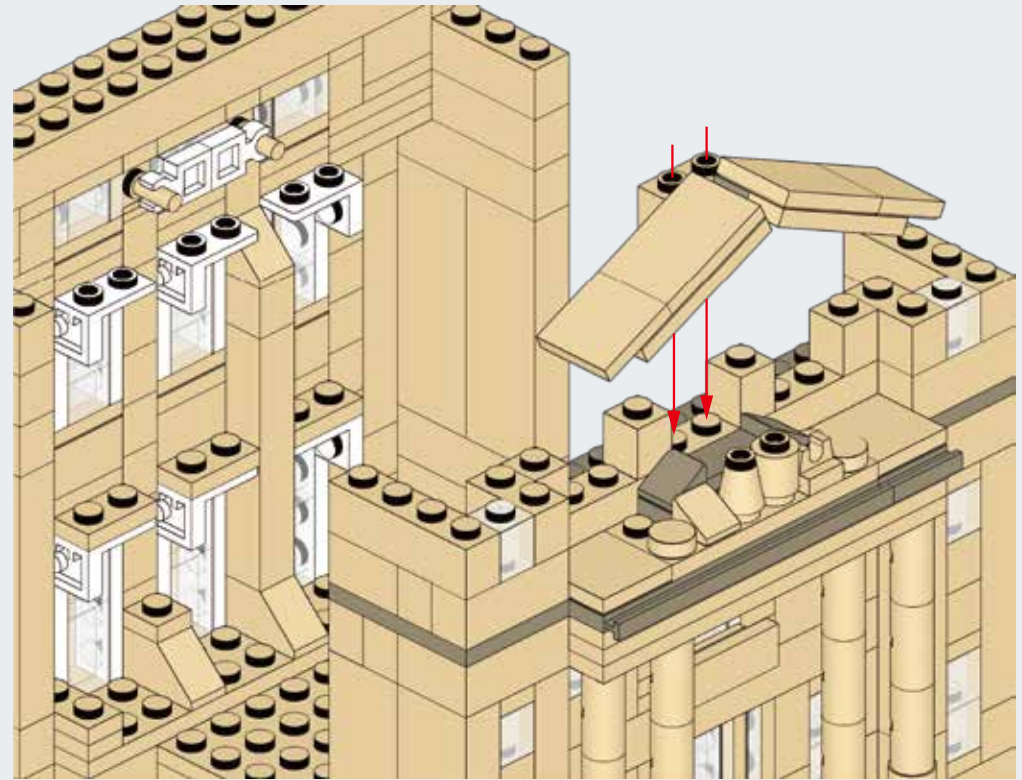
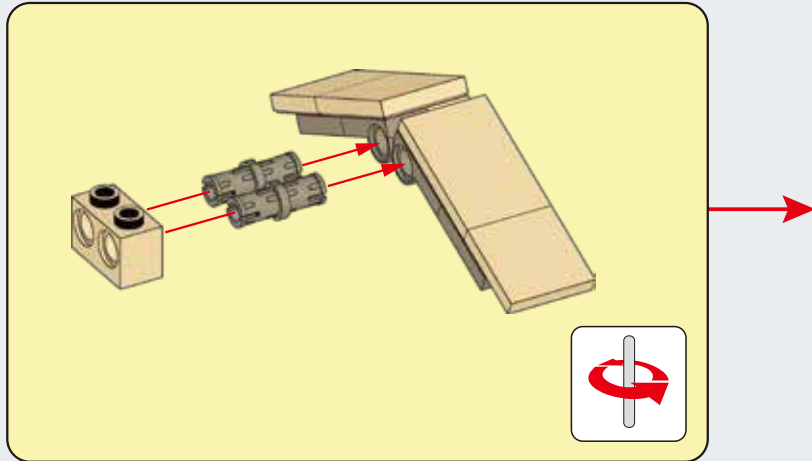

## C125

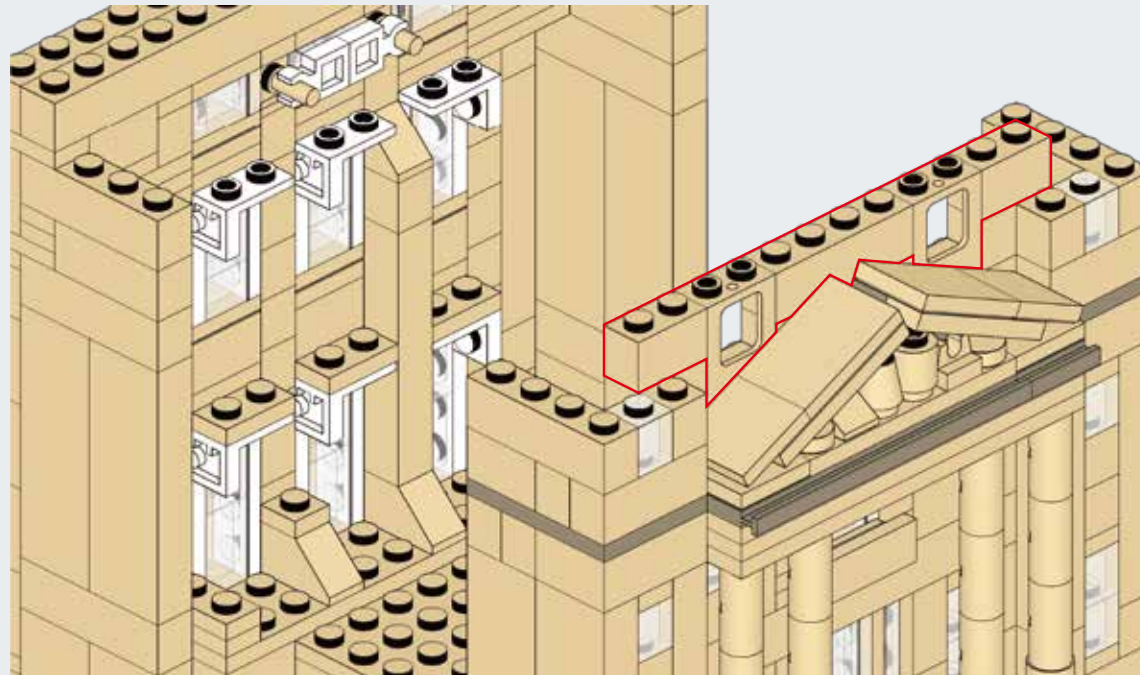

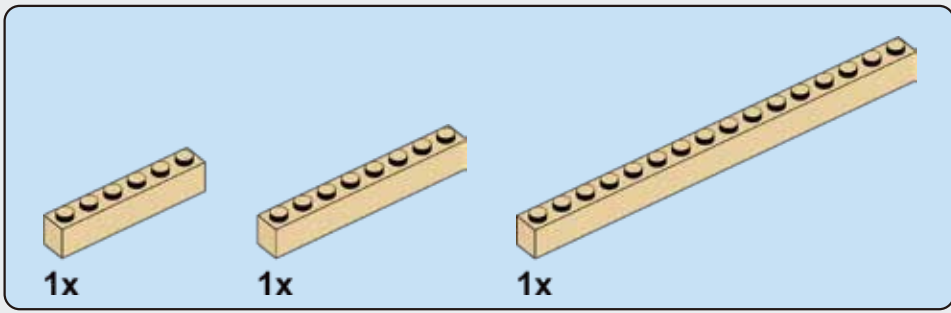

**C126**

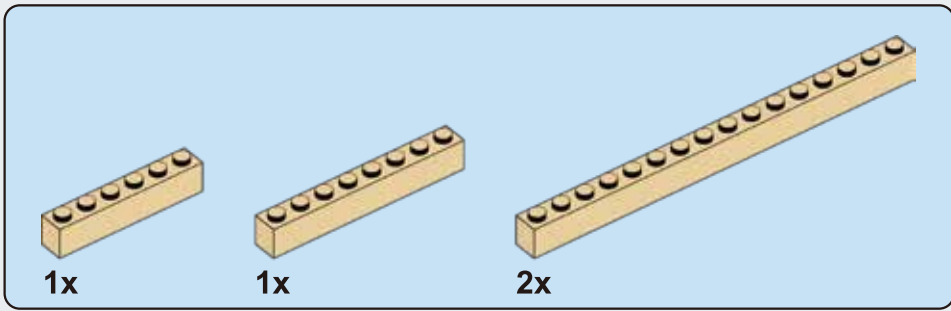
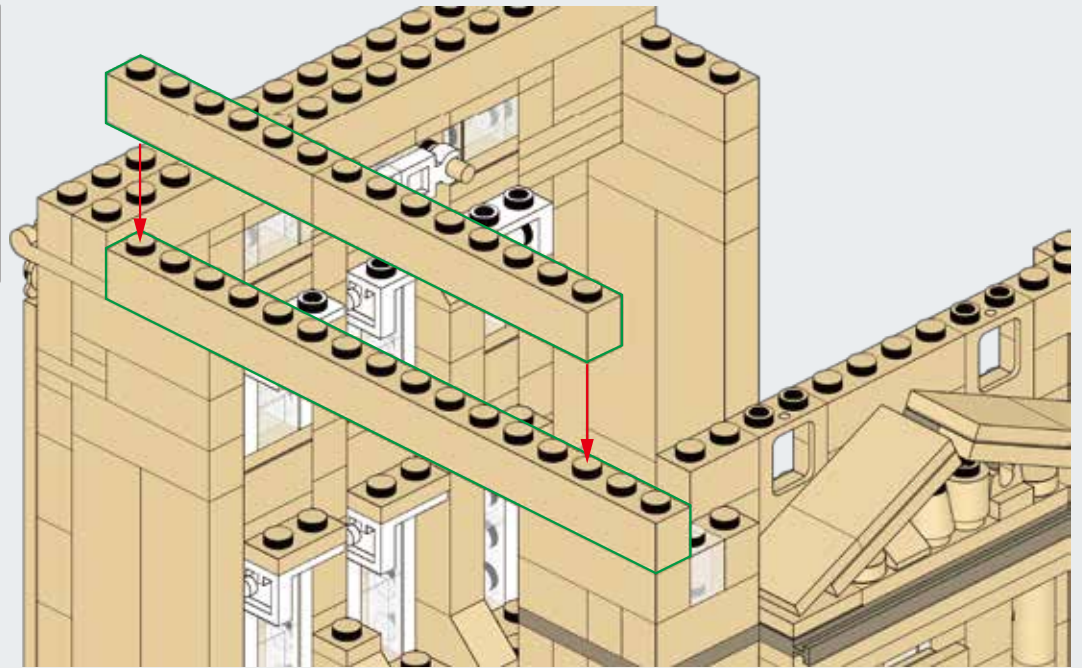

**C127**

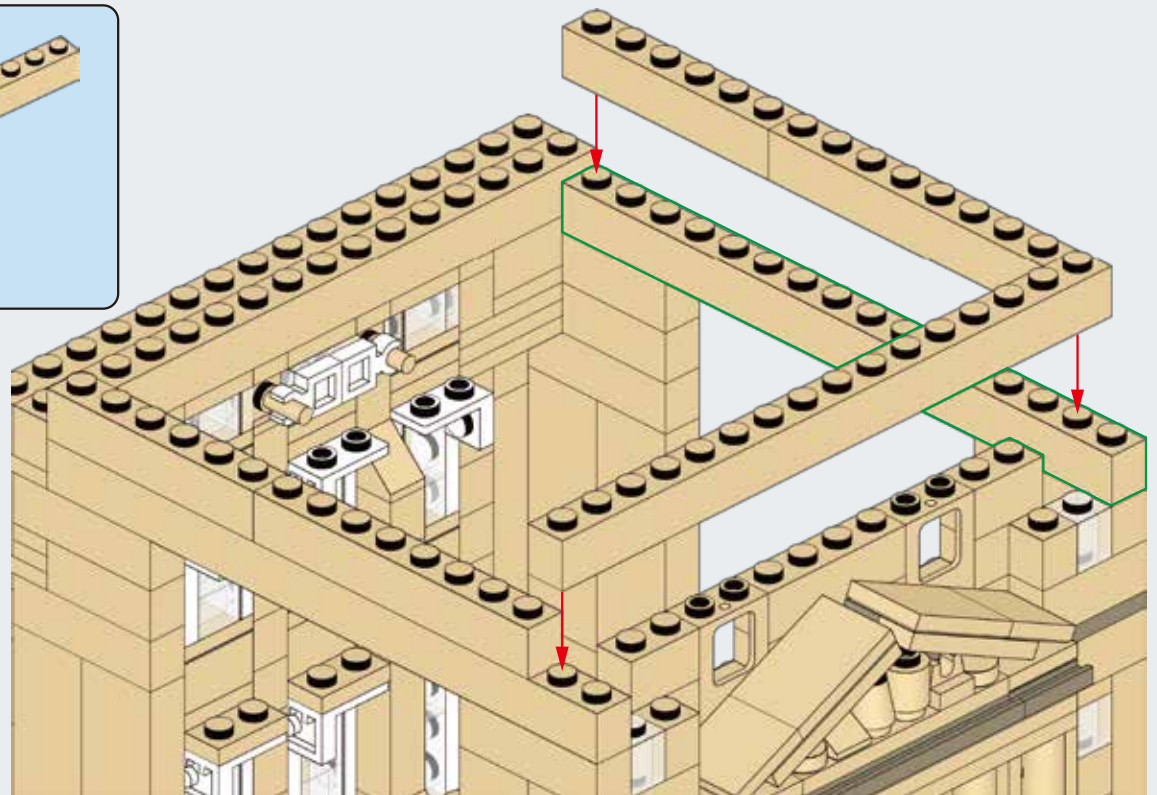

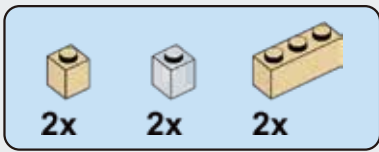

### C128

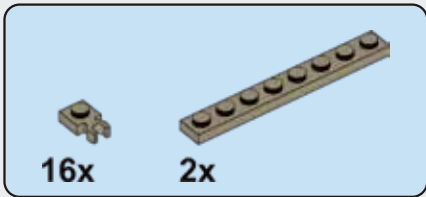
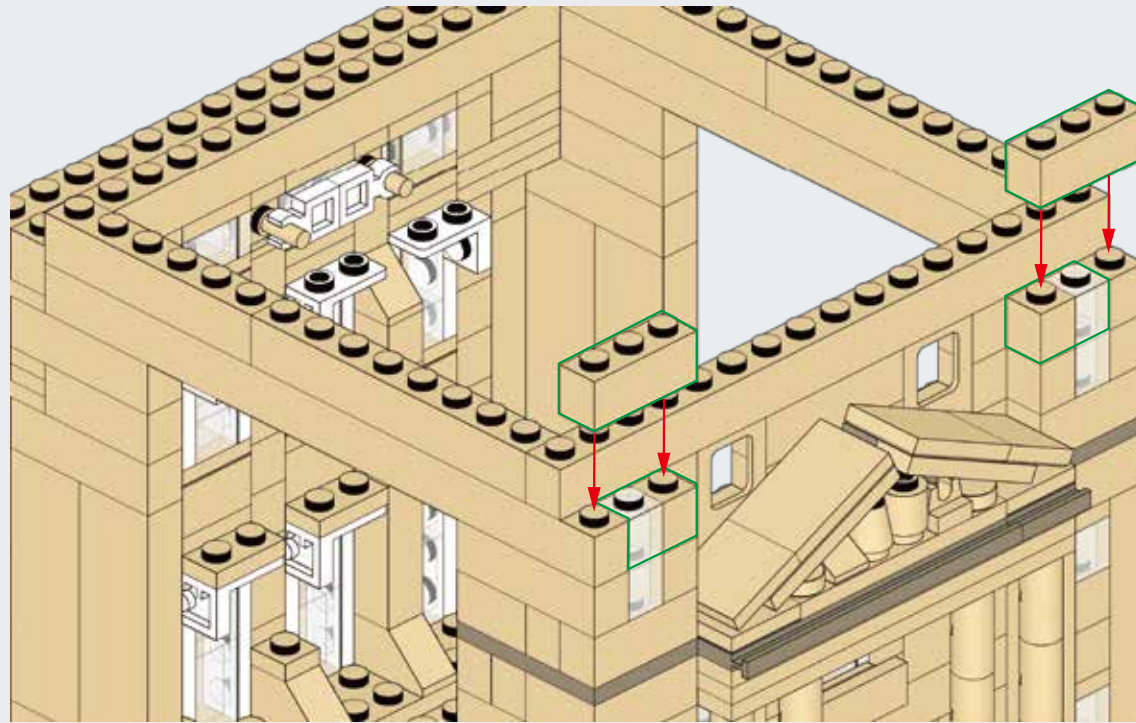

### C129

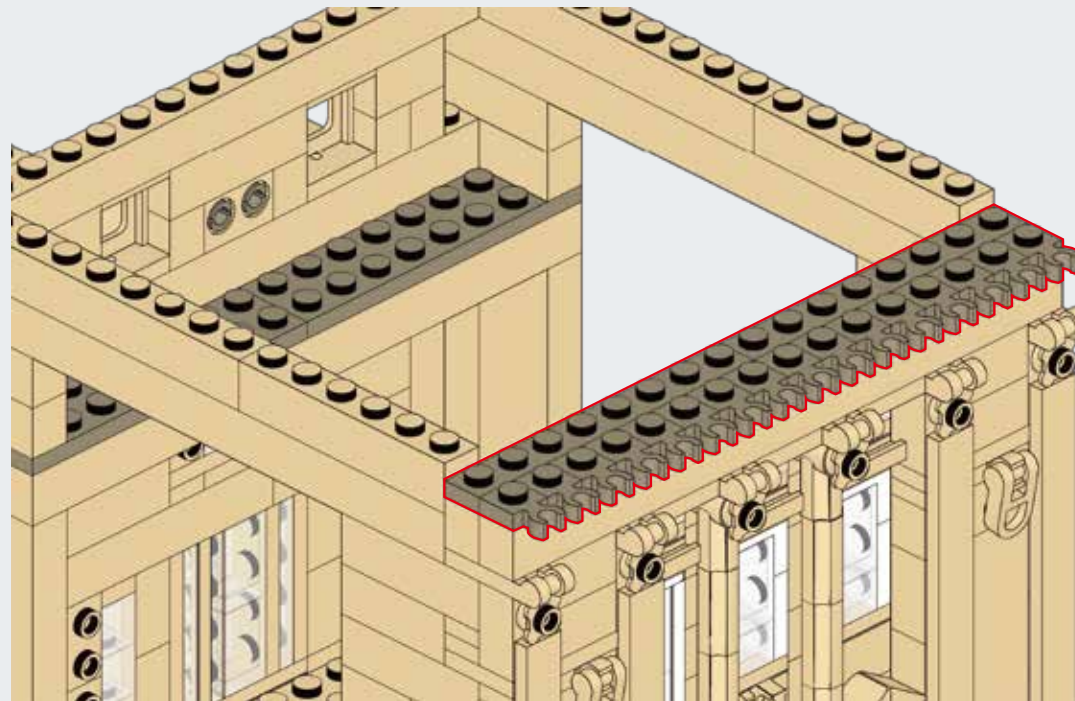
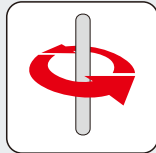



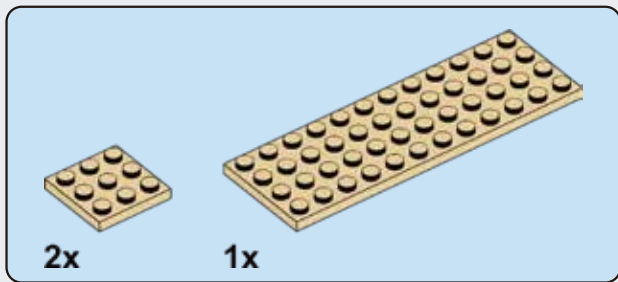

**C130**

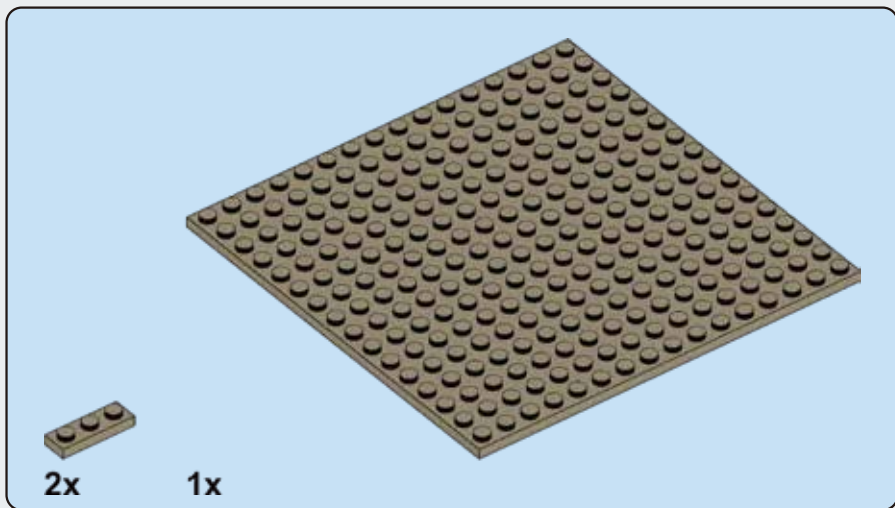
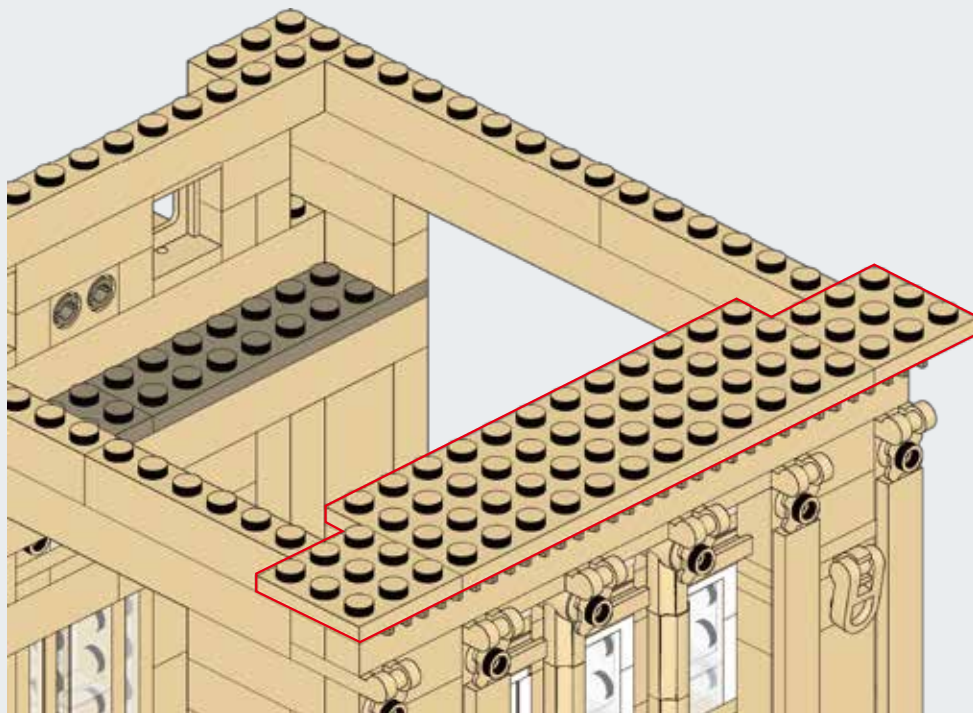

**C131**





## C132

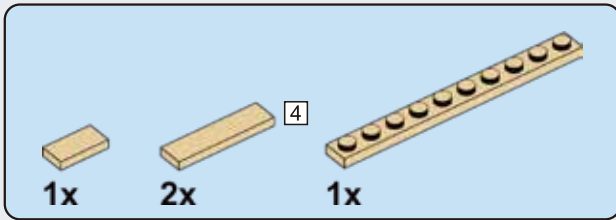
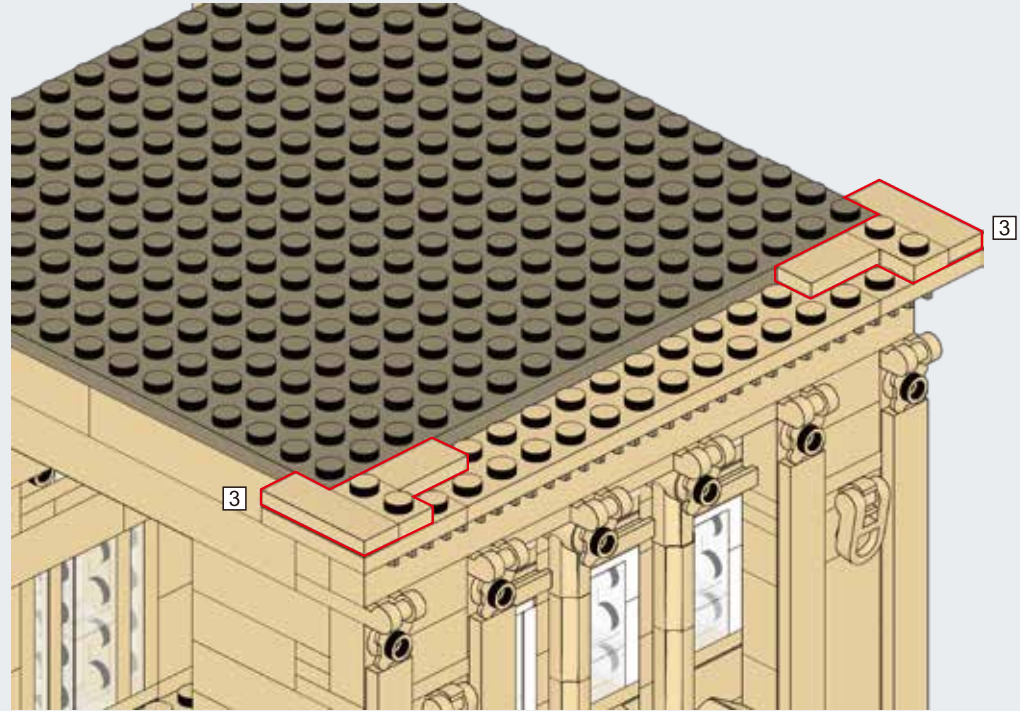

## C133

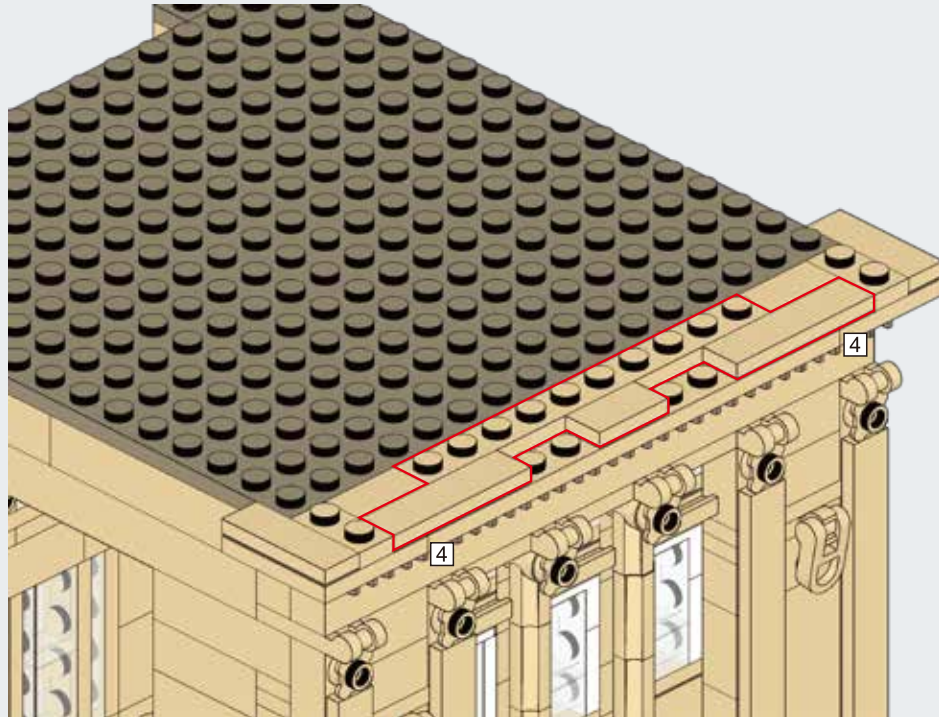

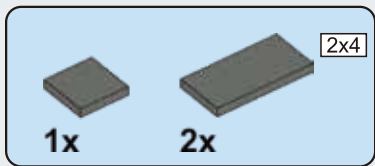

## C134

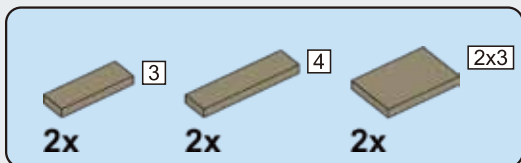

## C135

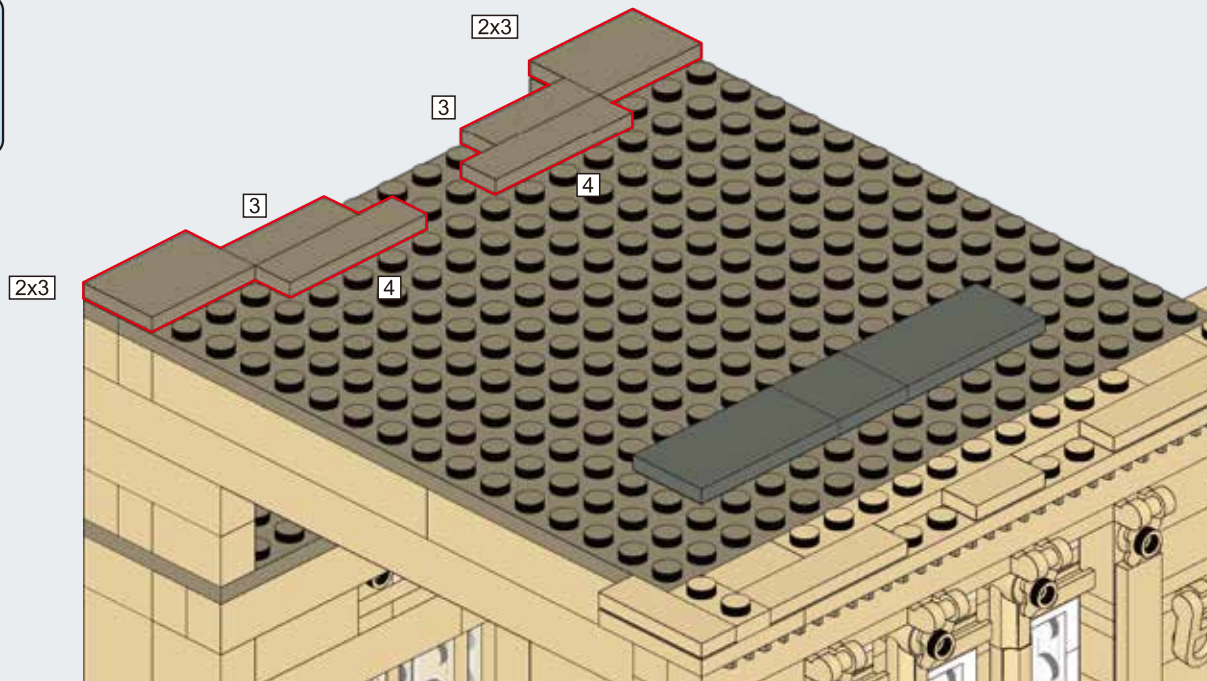

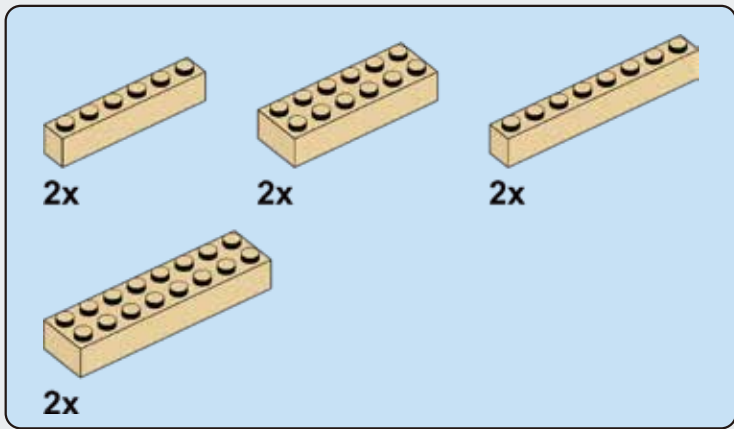

**C136**

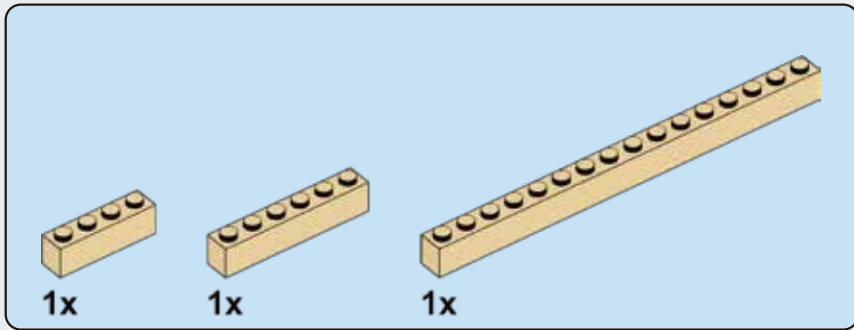
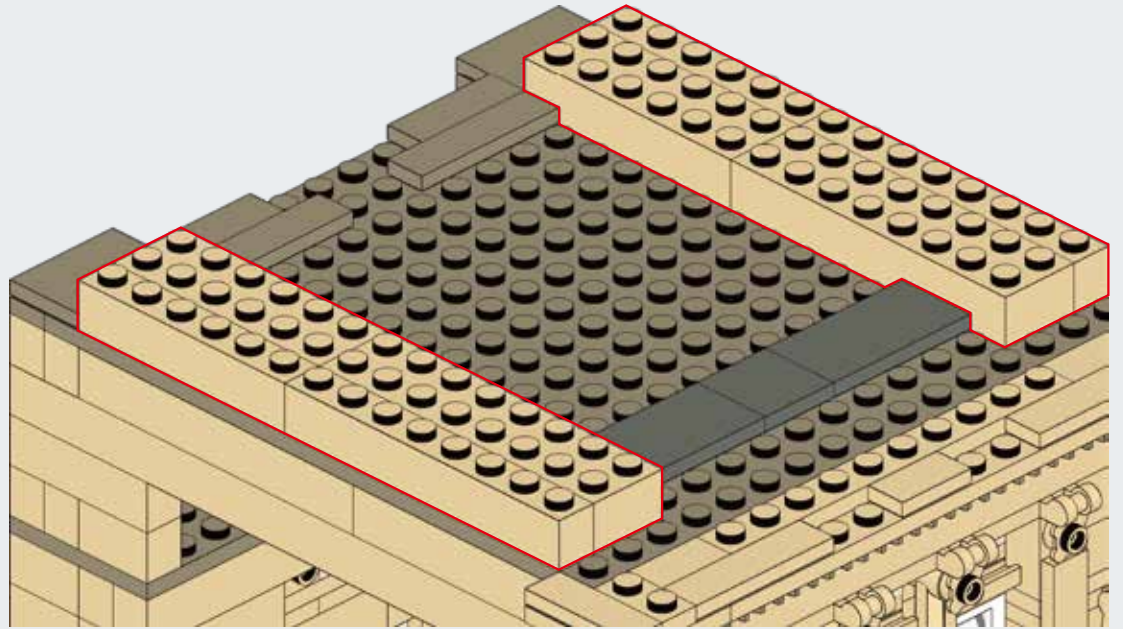

**C137**

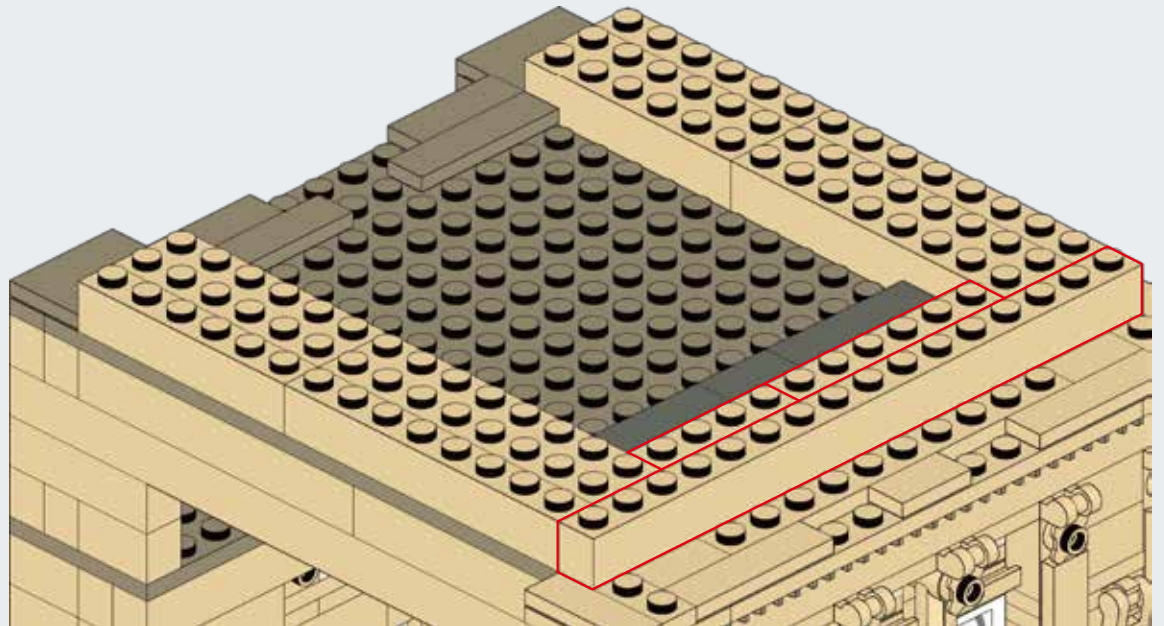

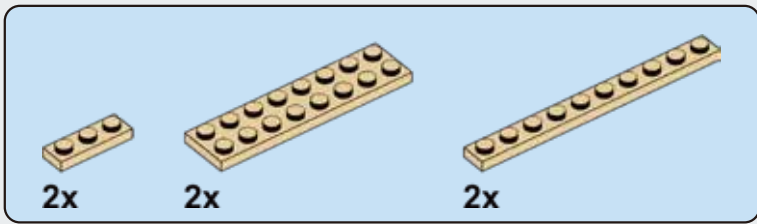

## C138

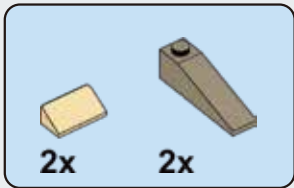
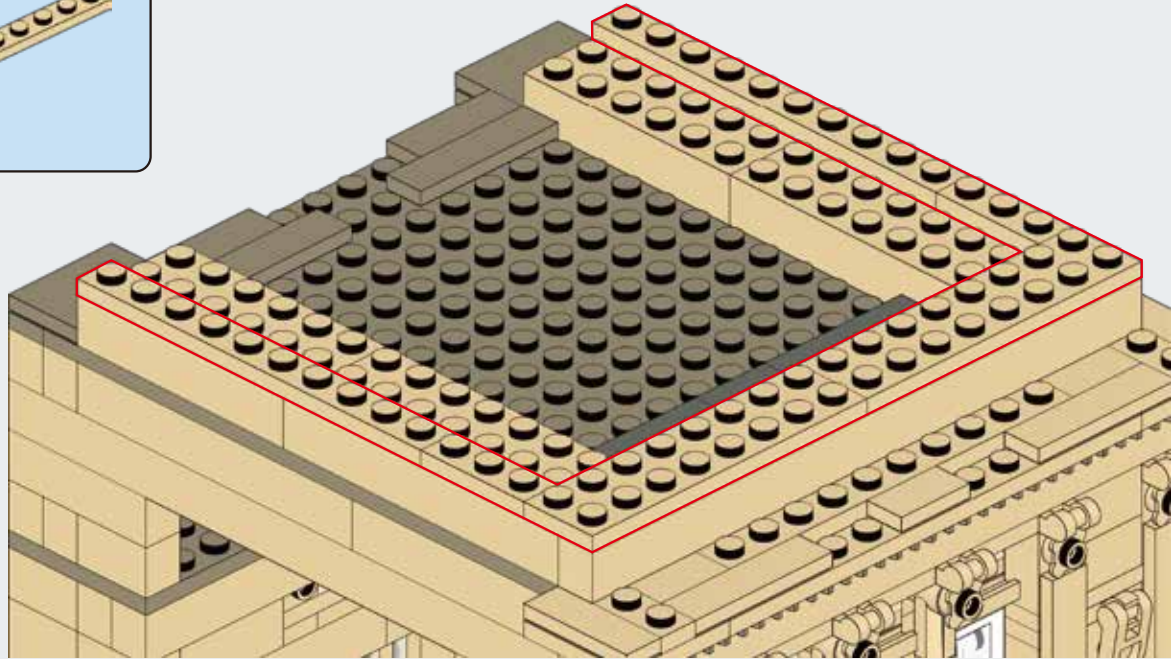

## C139

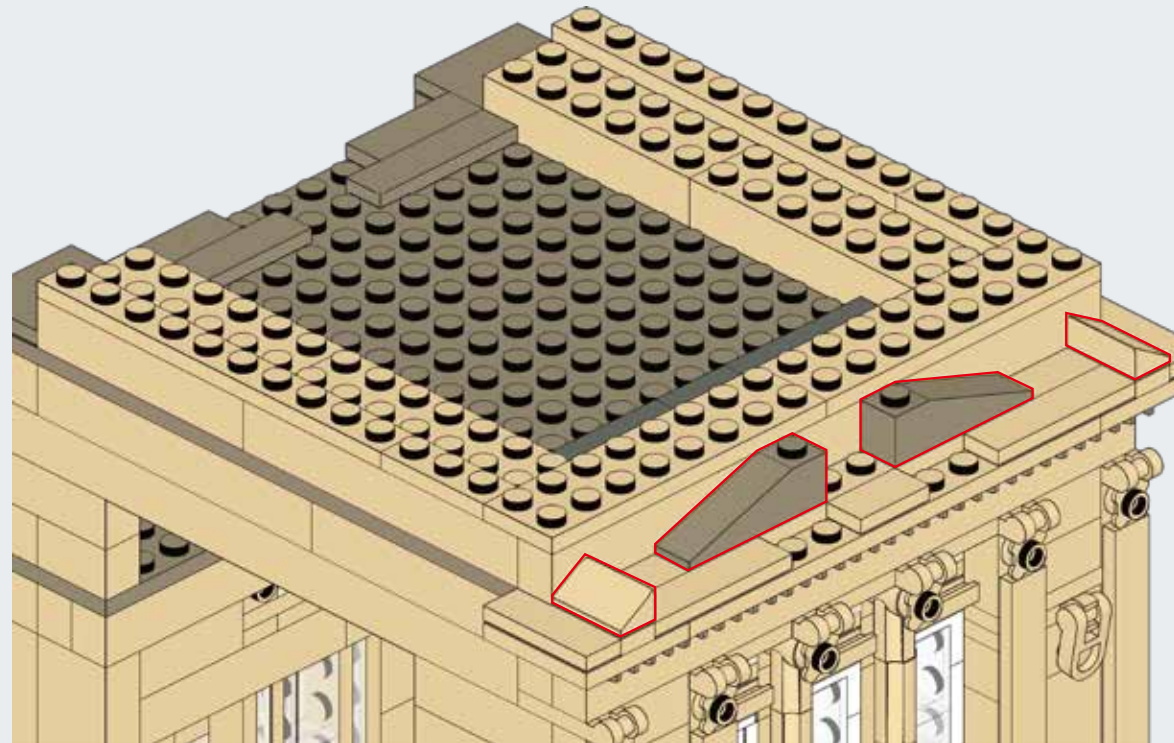

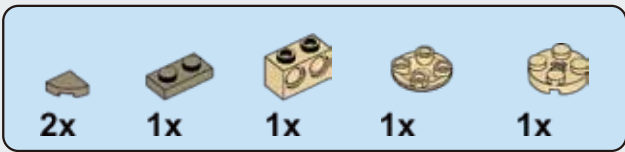

## C140

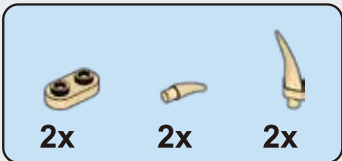
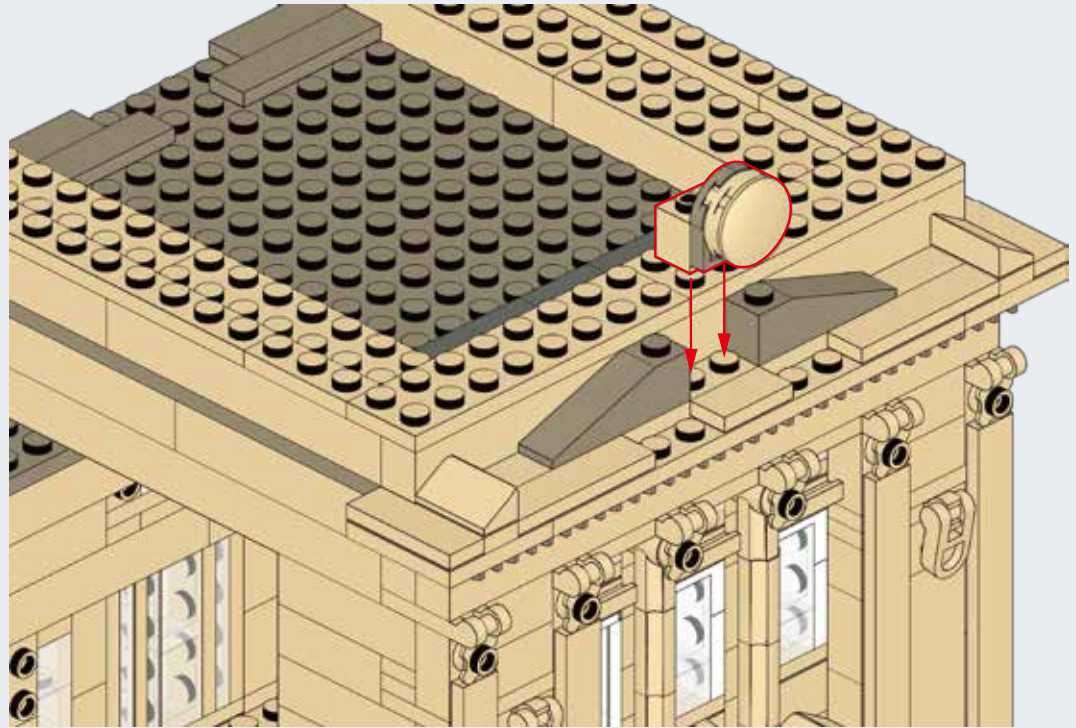
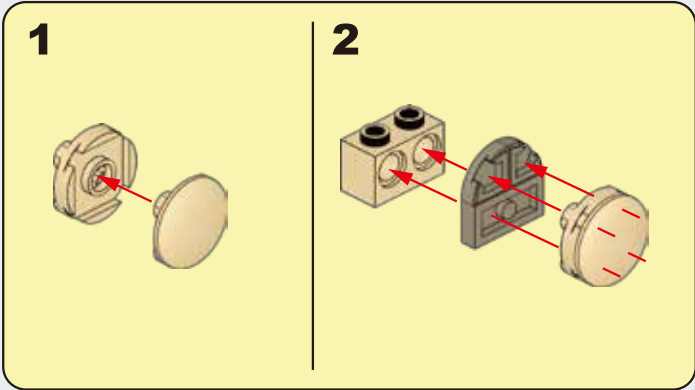

## C141

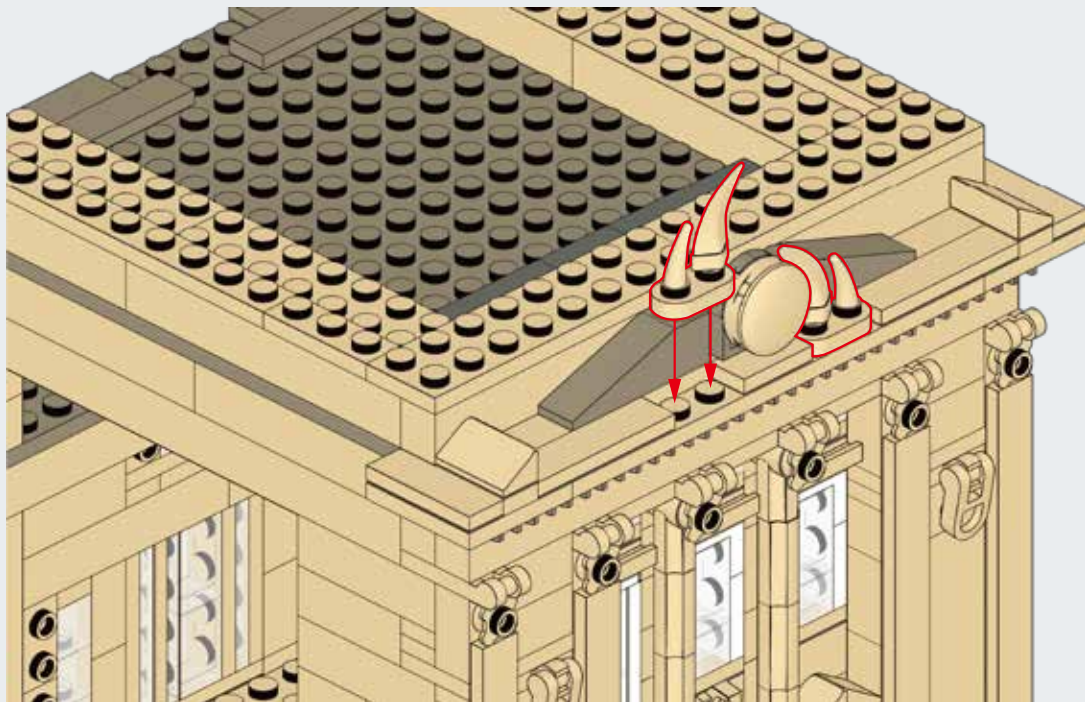
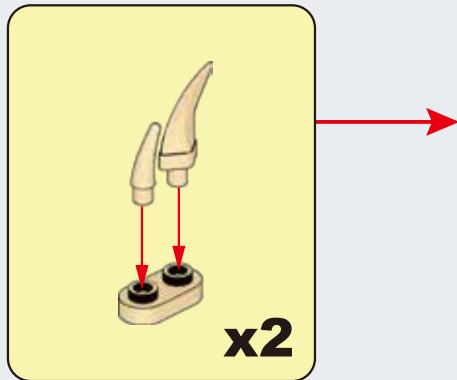

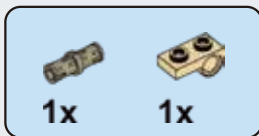

### C142

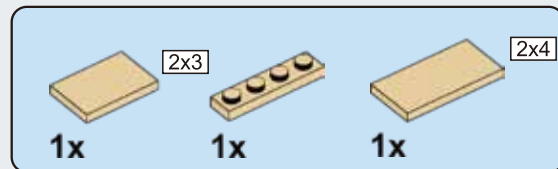
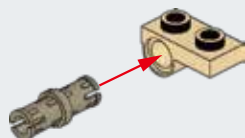

### C143

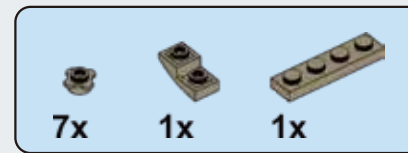
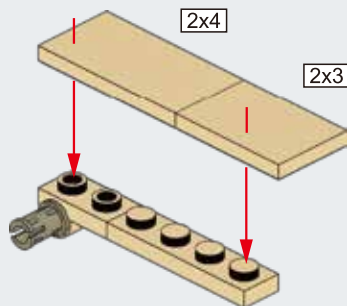

### C144

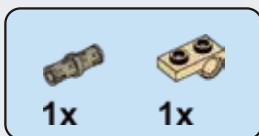
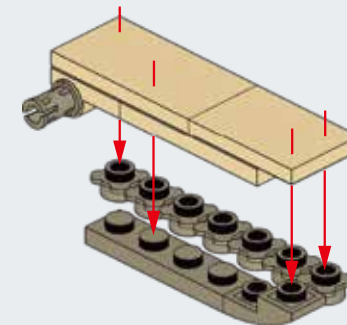

### C145

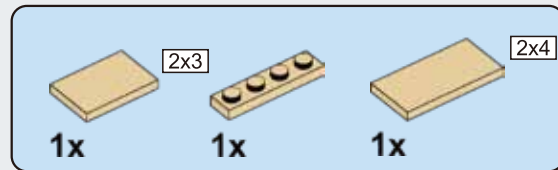
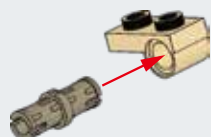

### C146

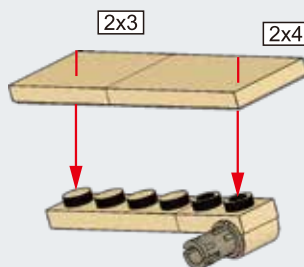

### C147

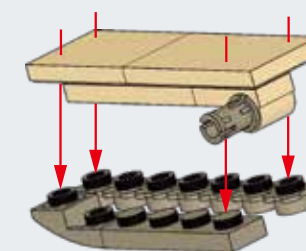

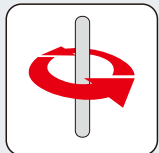

**C148**

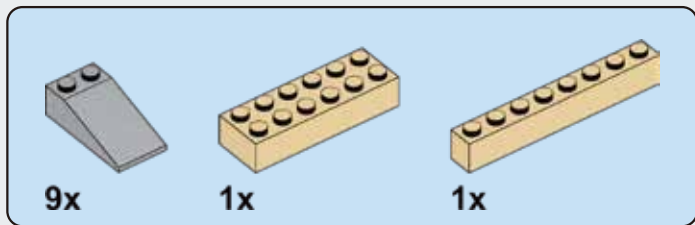
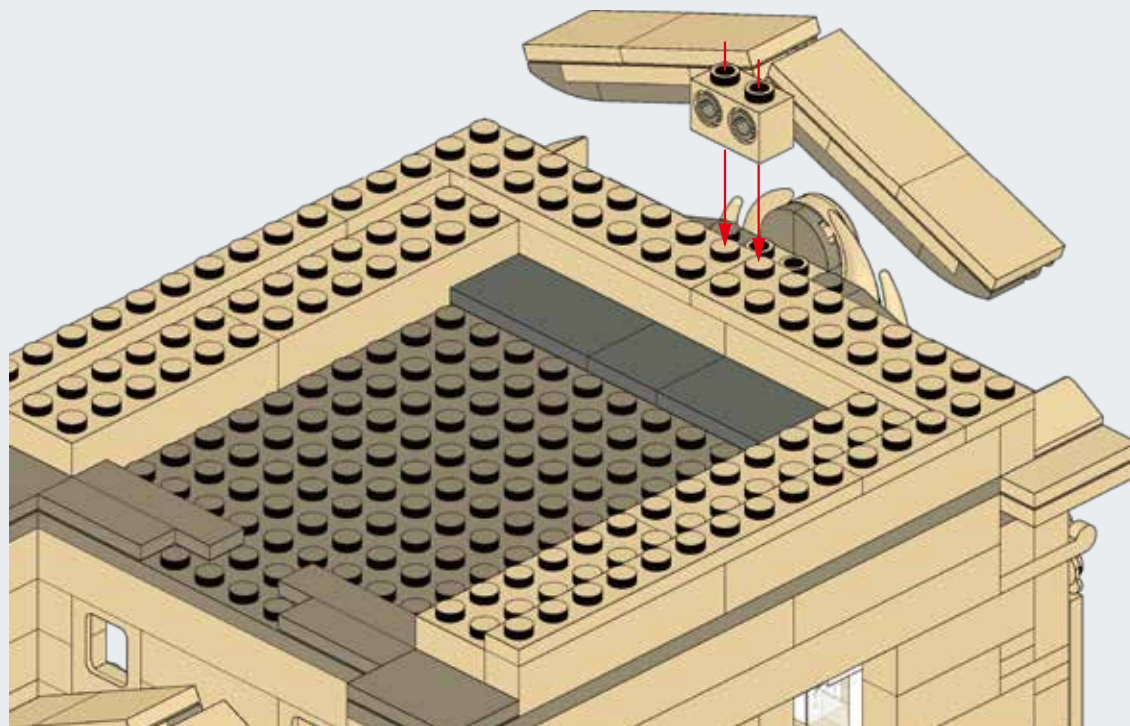
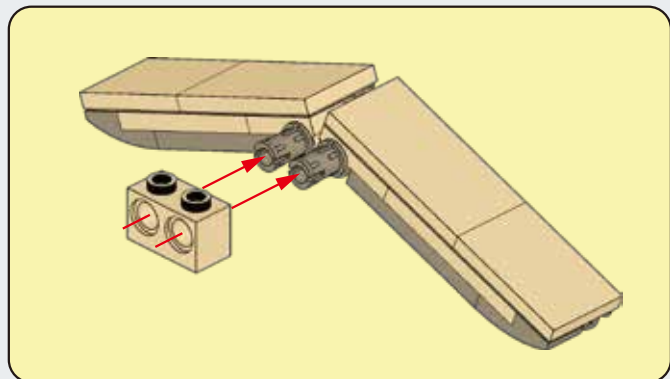

**C149**

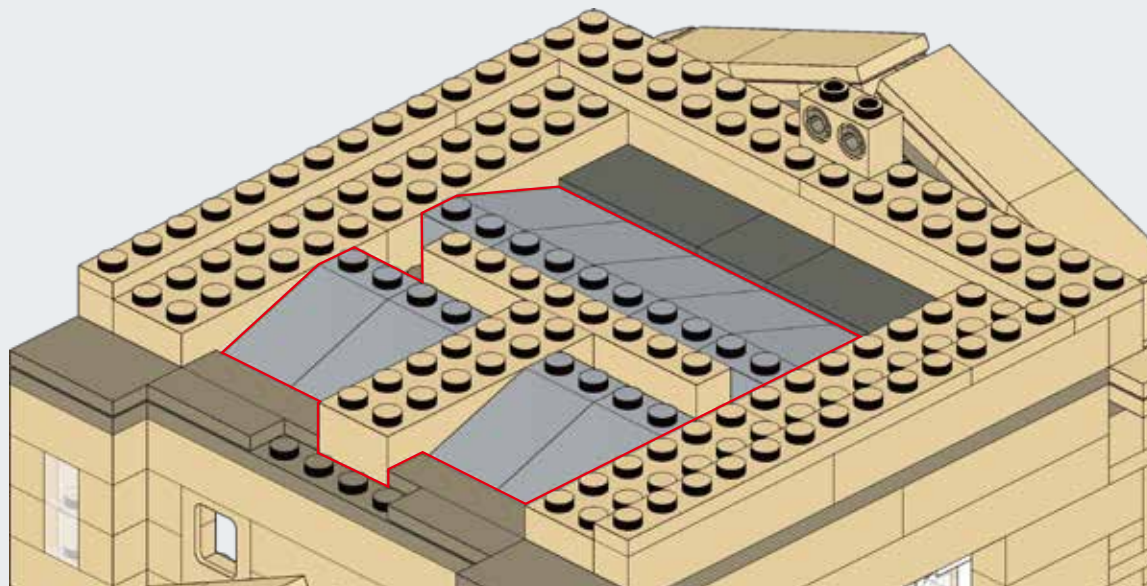



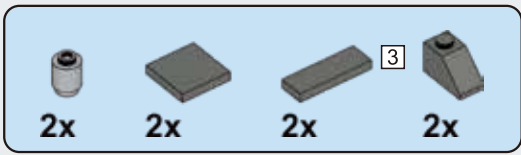

## C150

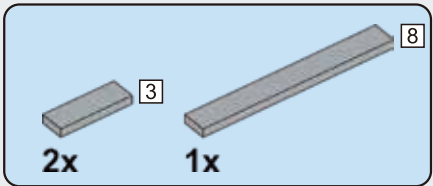
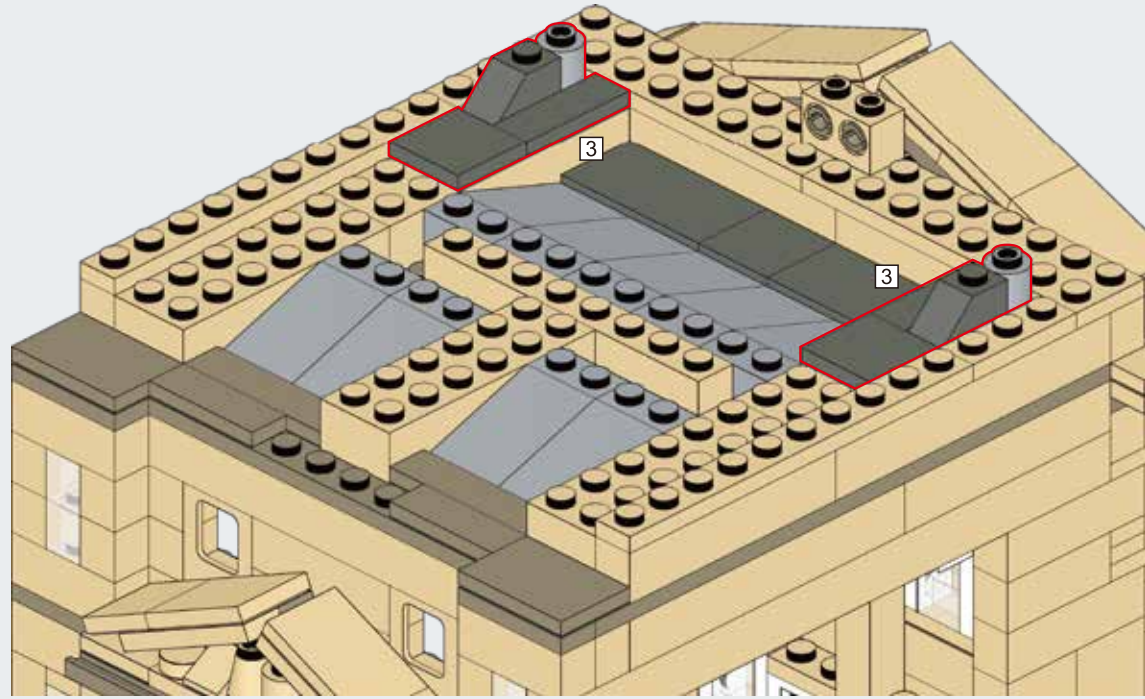

## C151

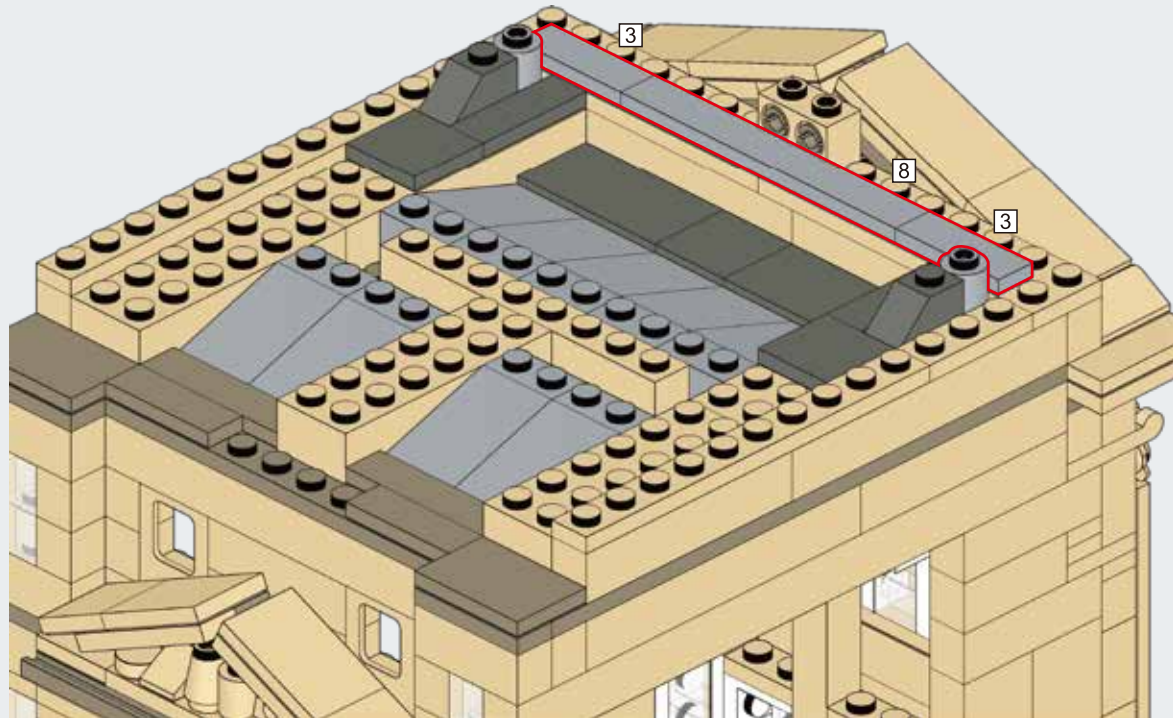



**C152**

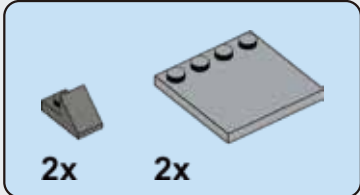
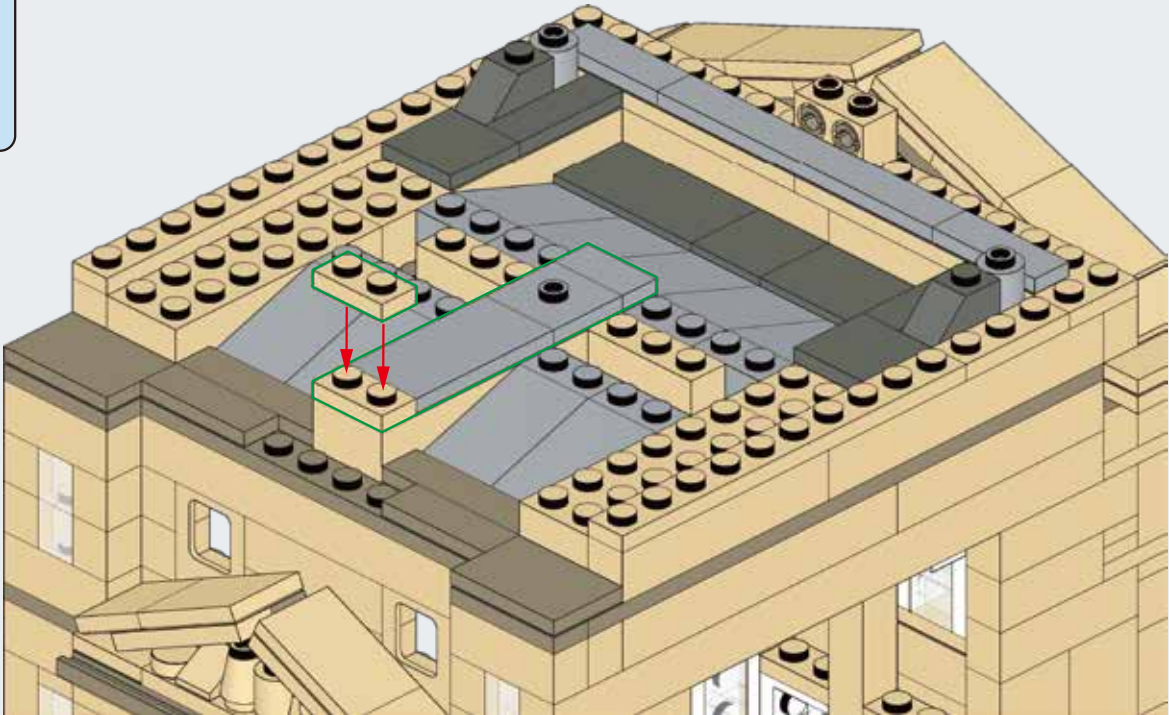

**C153**

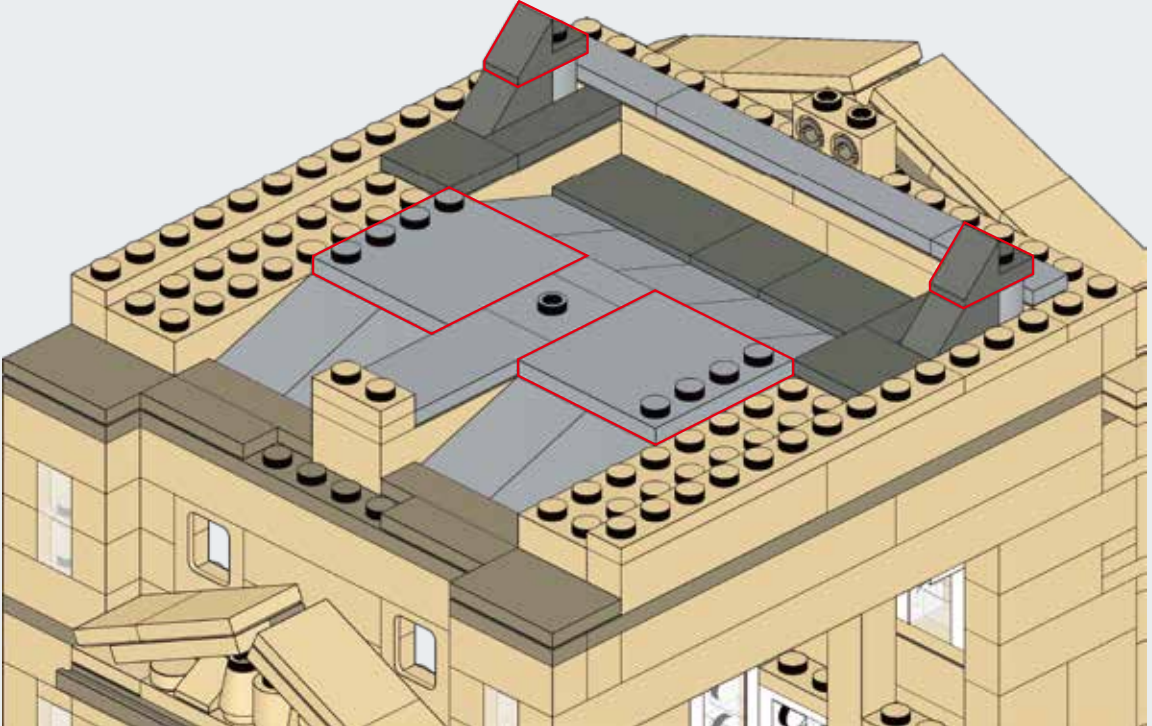



## C154

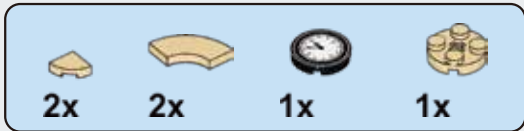
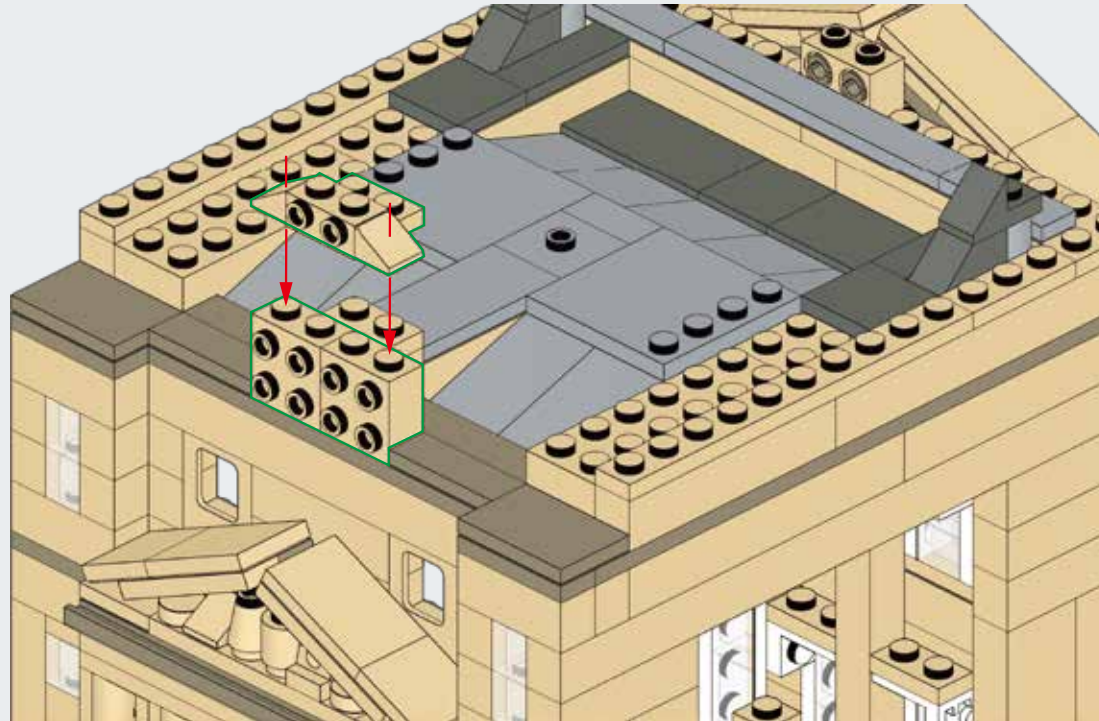

## C155

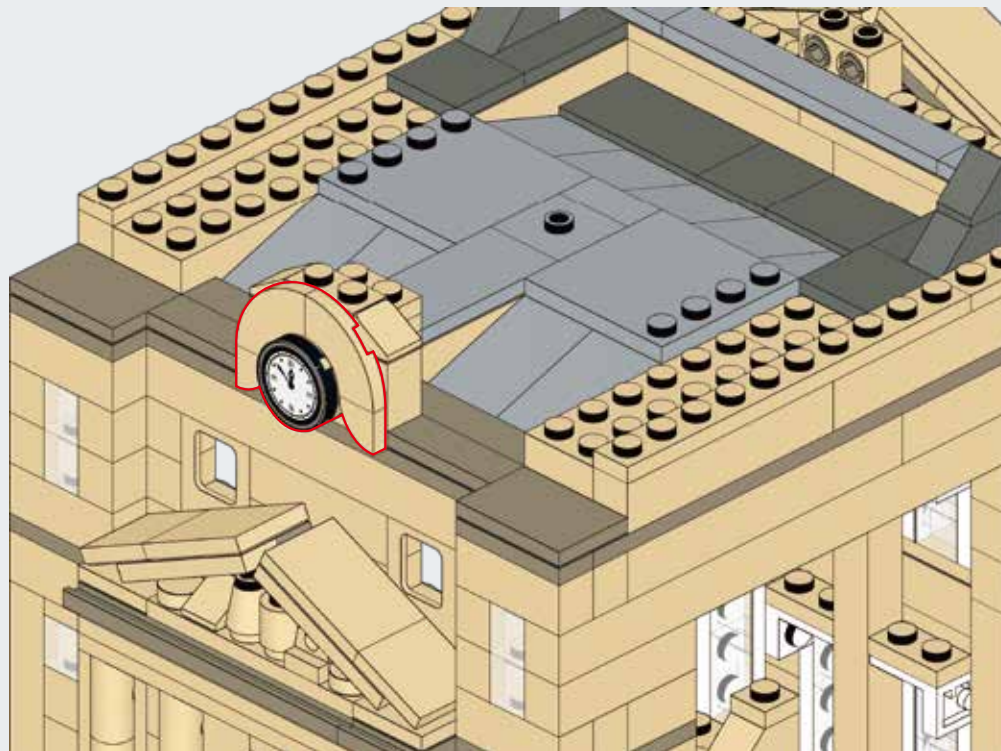
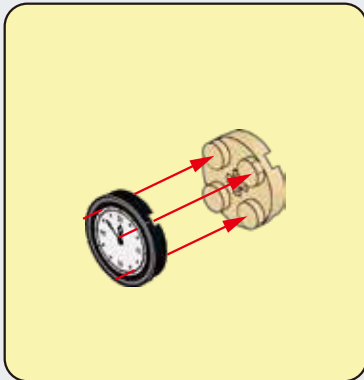

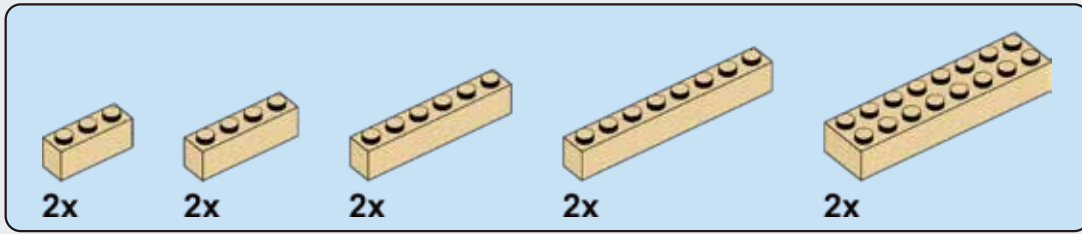

## C156

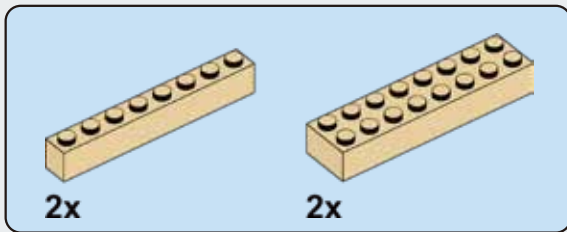
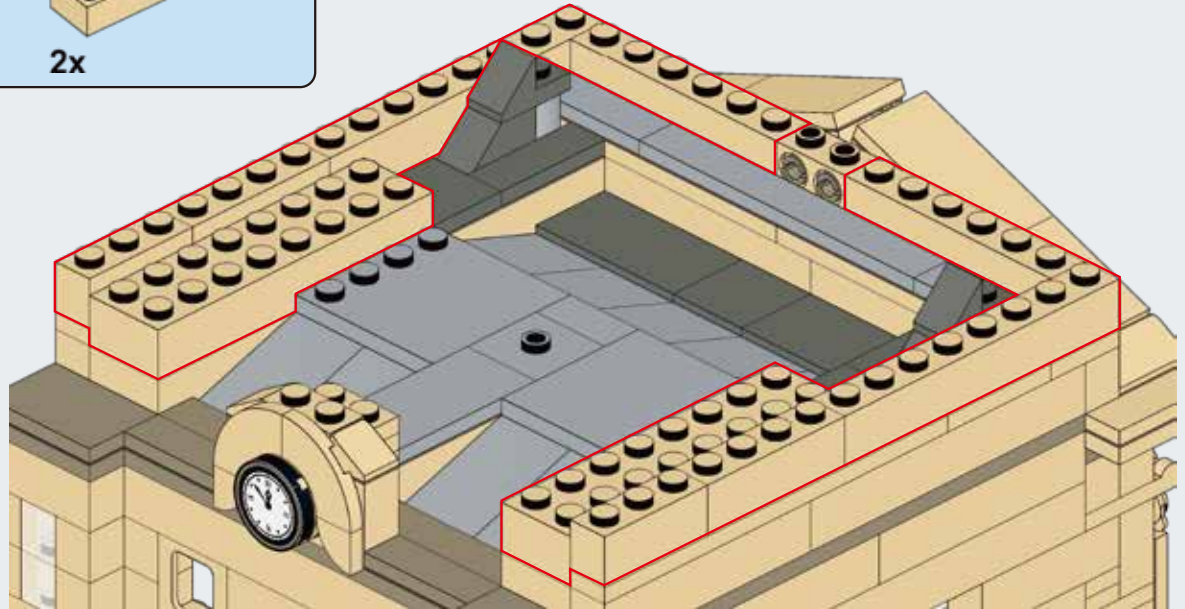

## C157

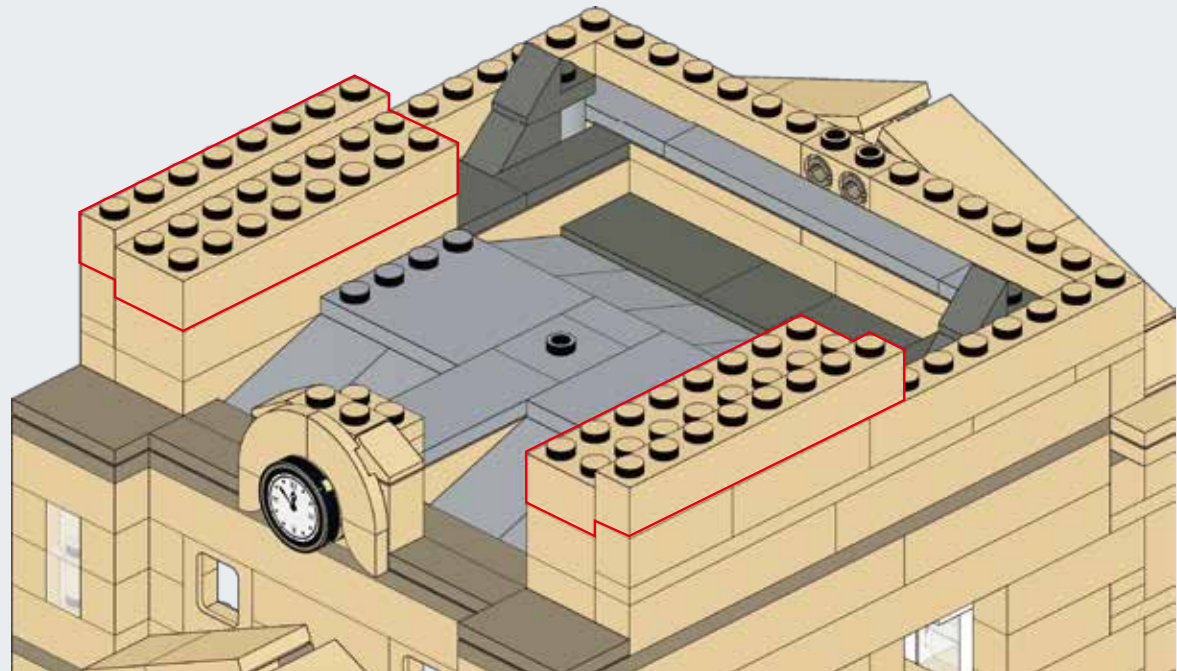

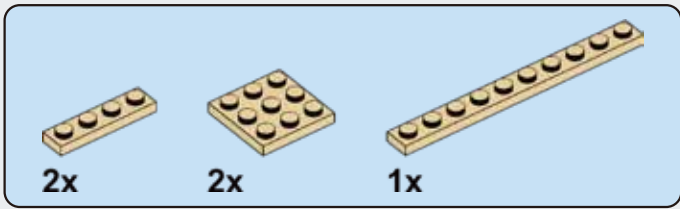

## C158

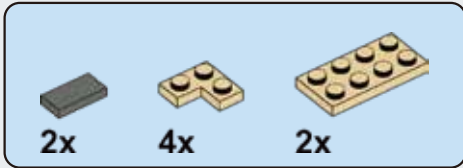
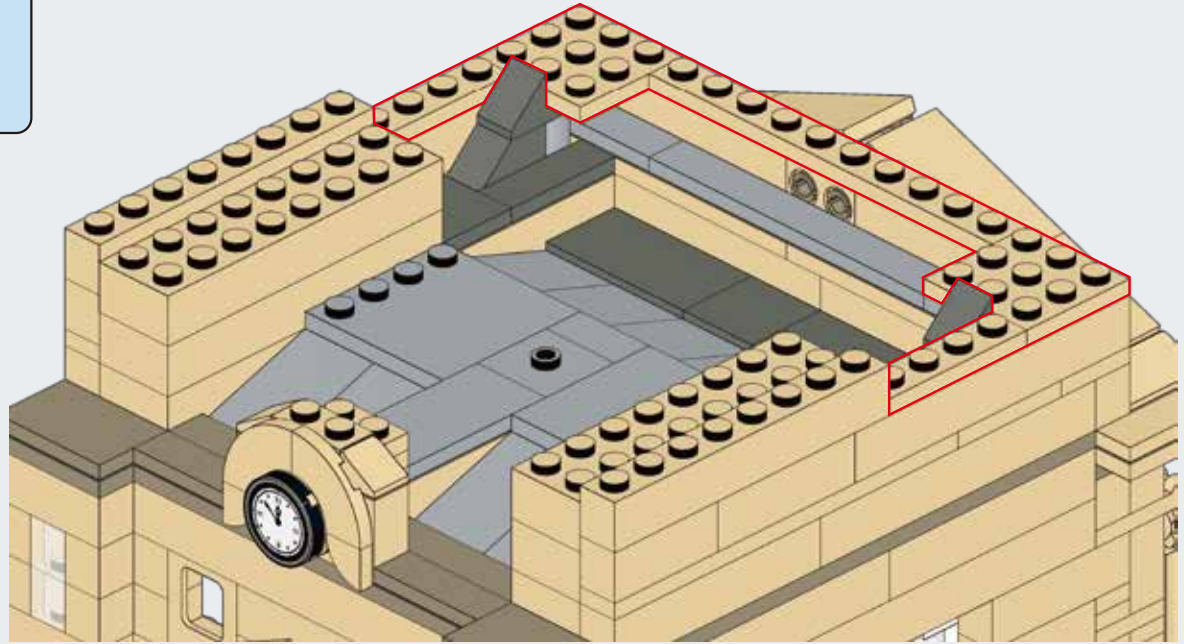

## C159

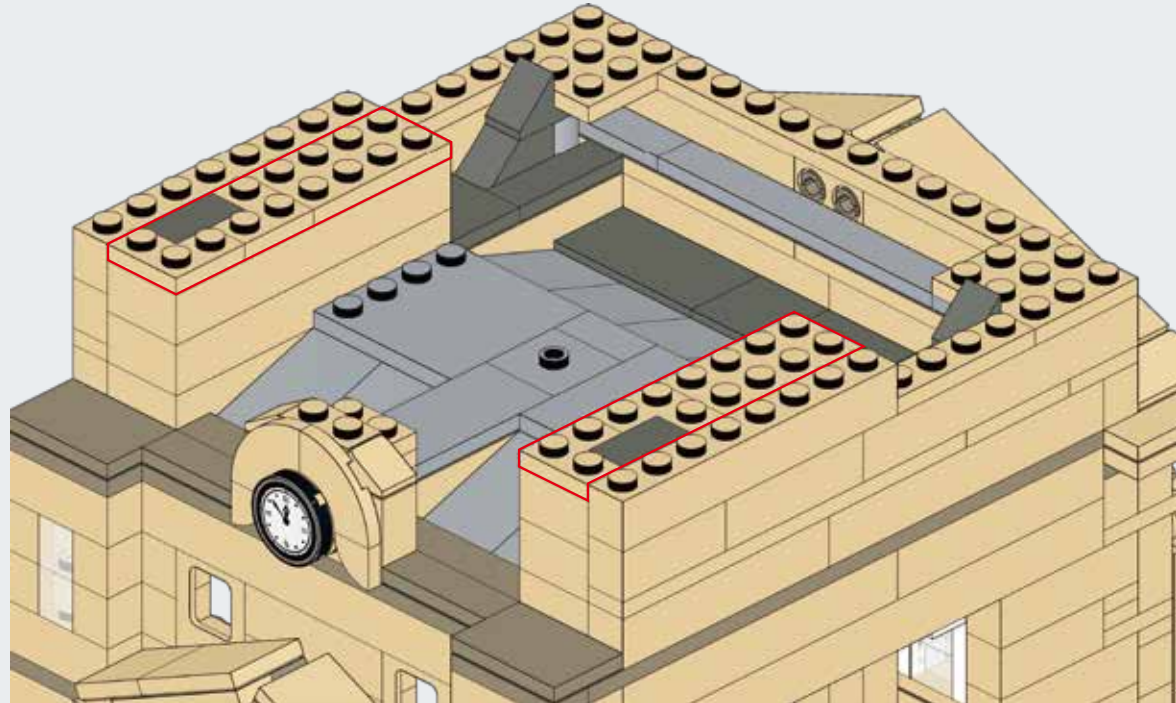

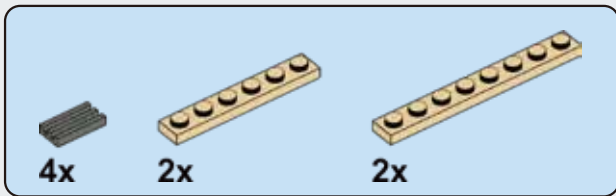

## C160

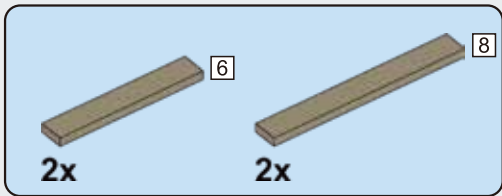
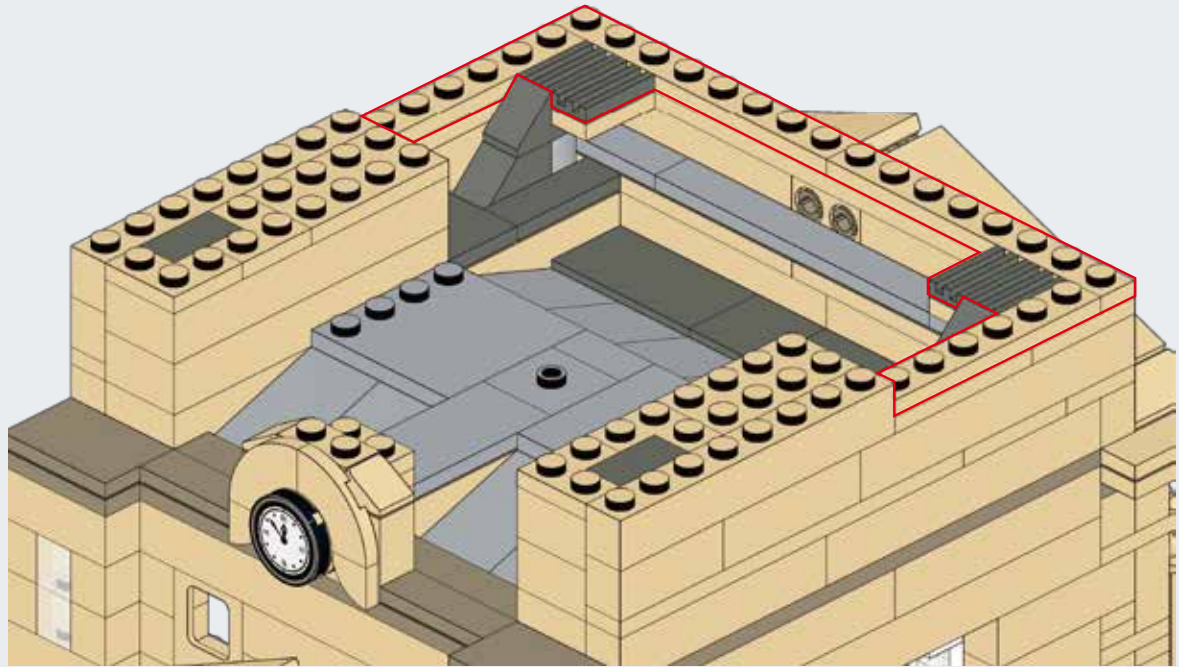

## C161

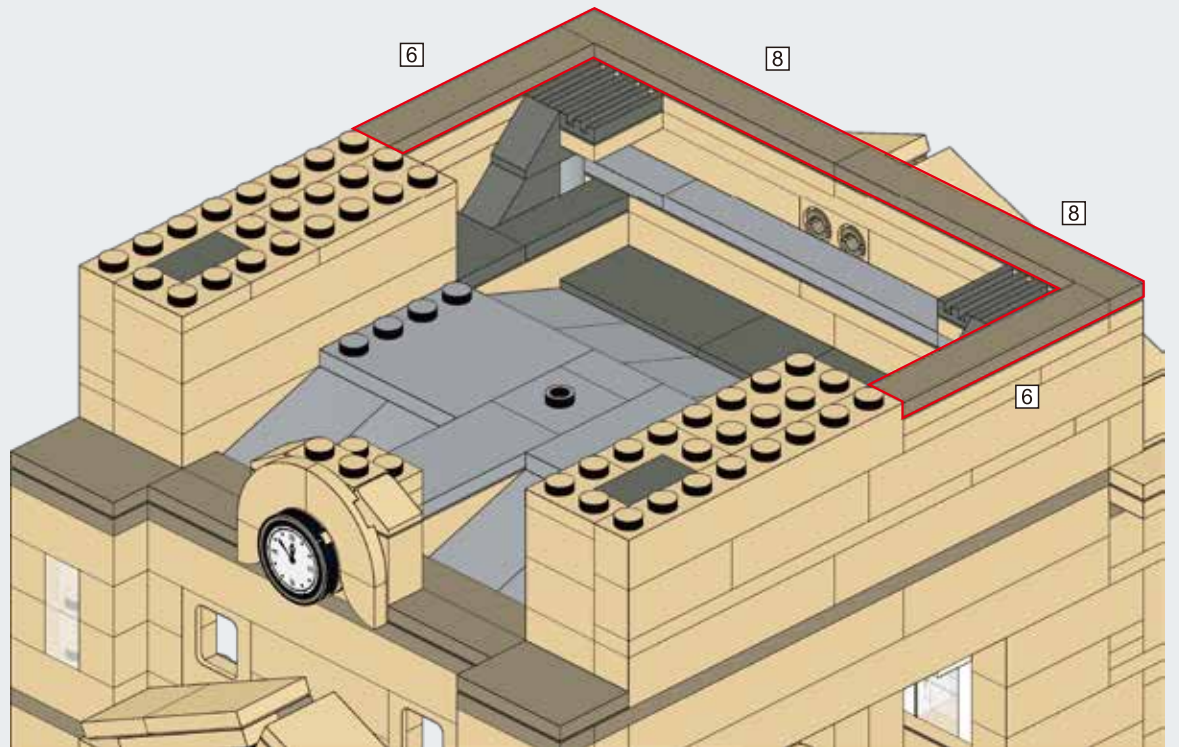

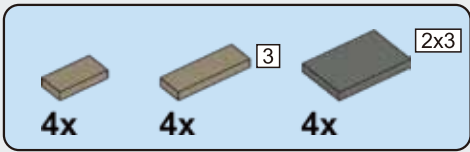

## C162

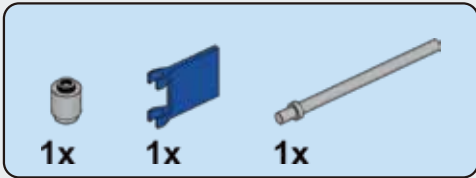
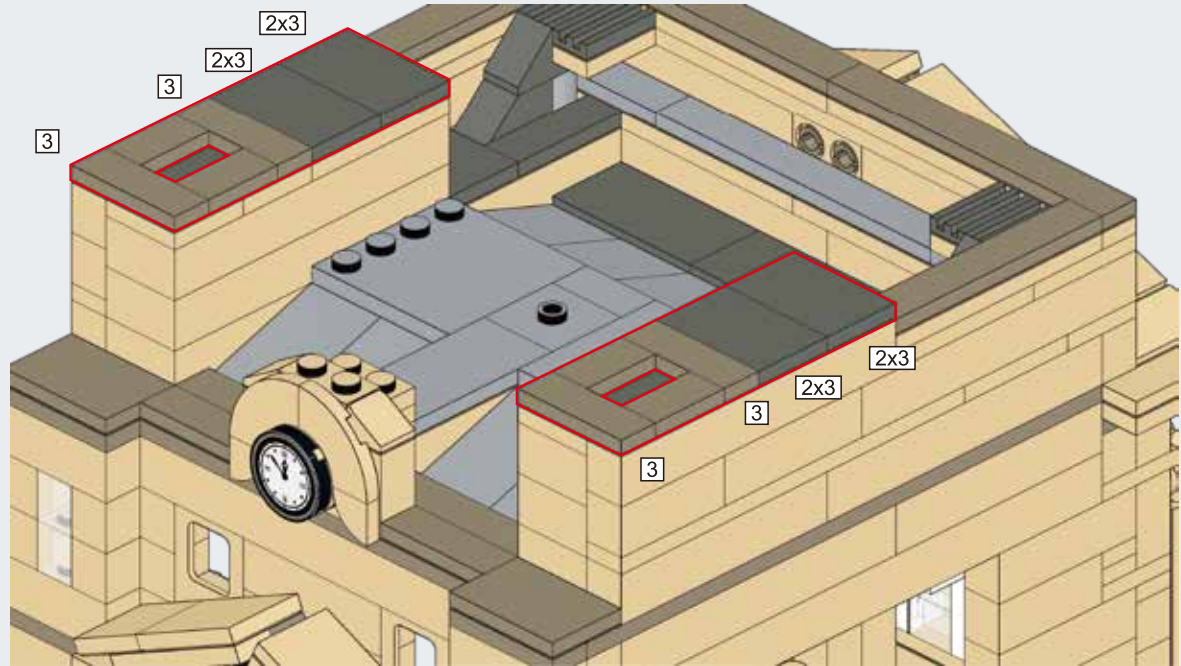

## C163

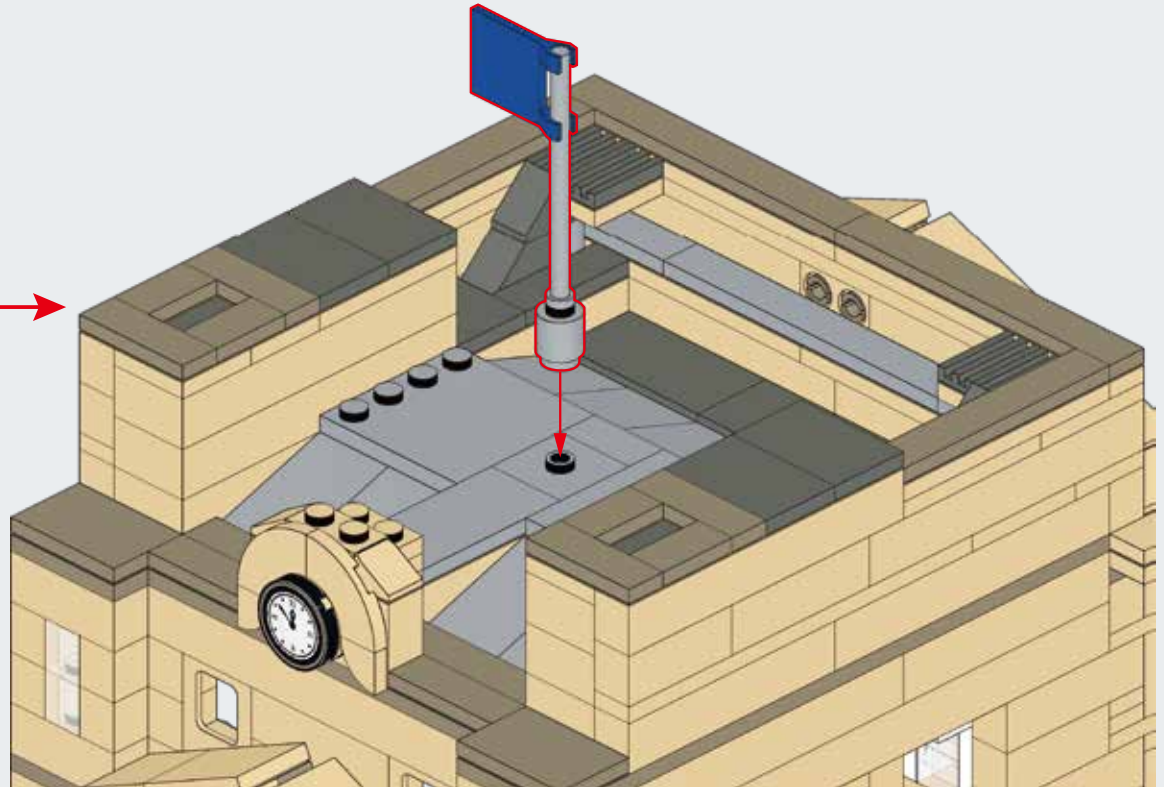
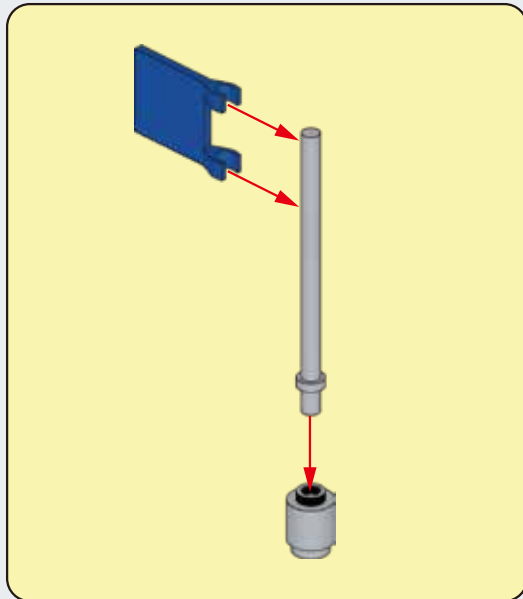

C164

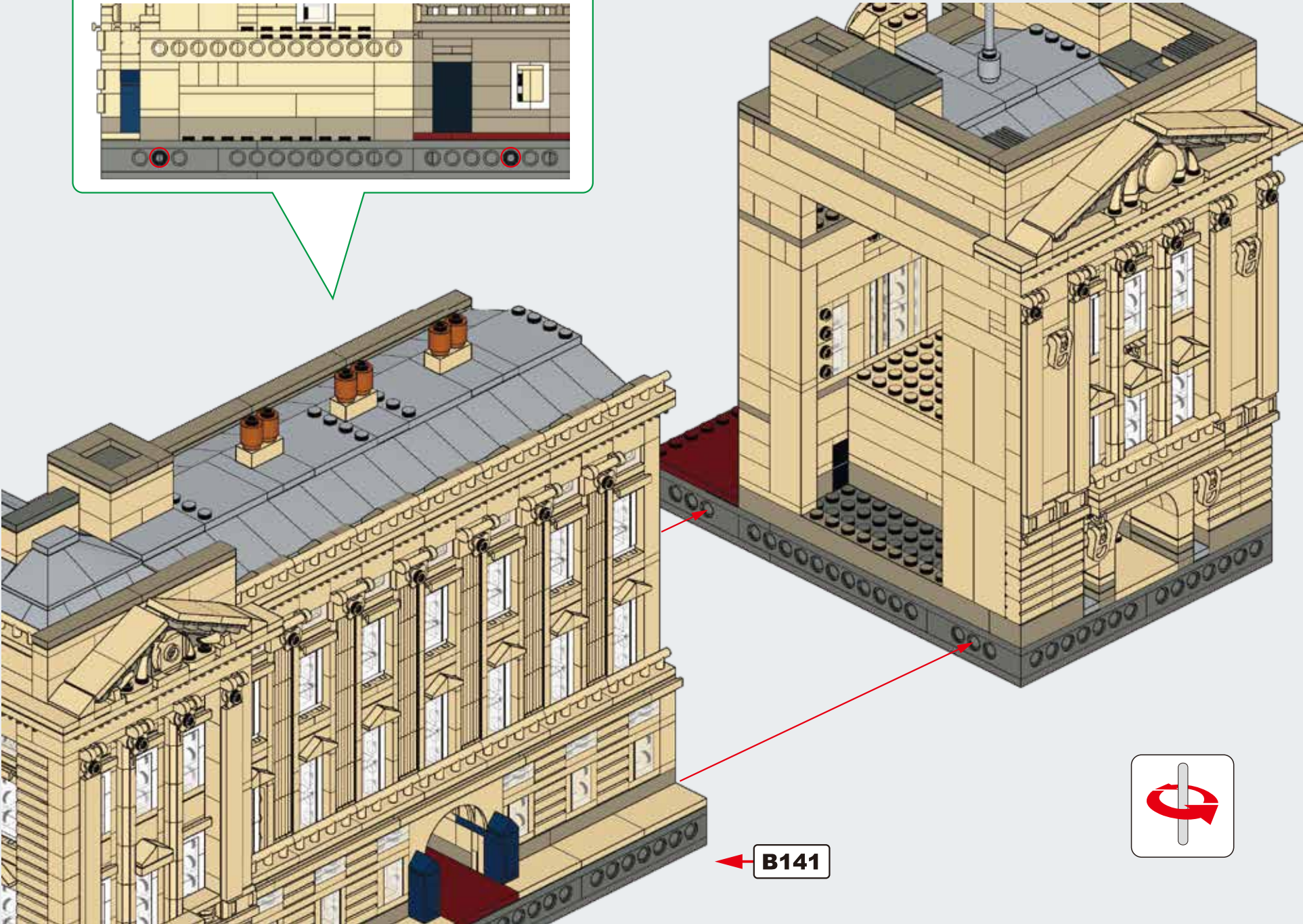
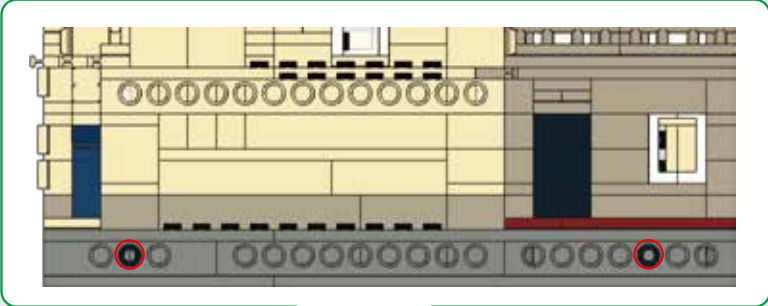

**B141**

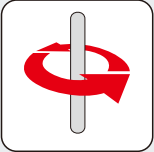



**D**

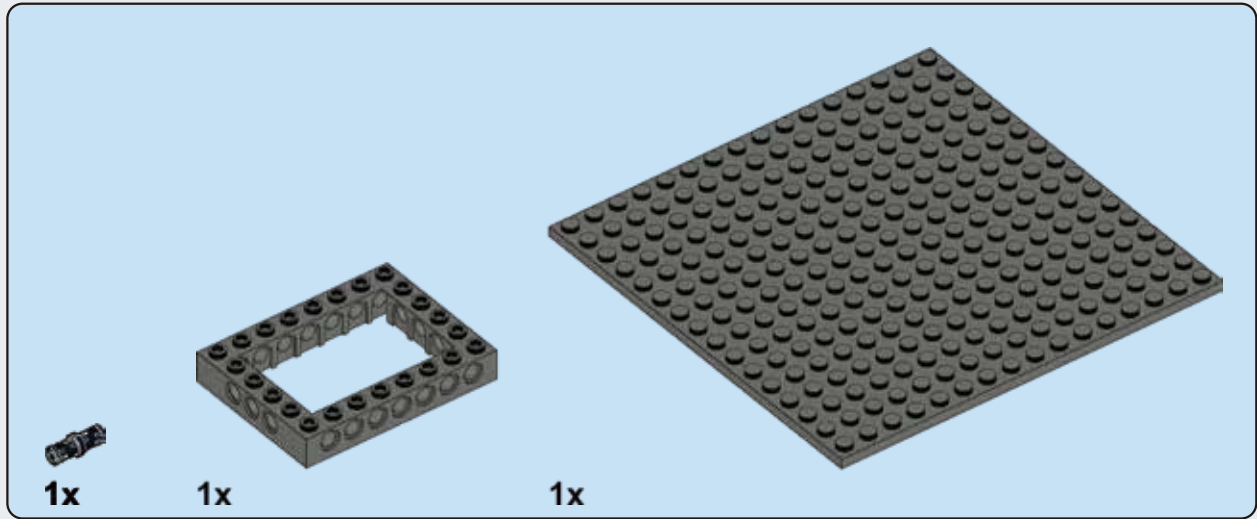
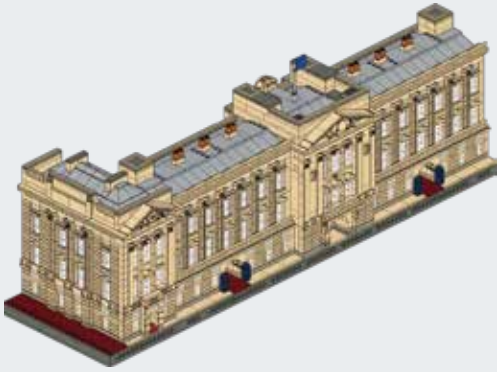

**D1**

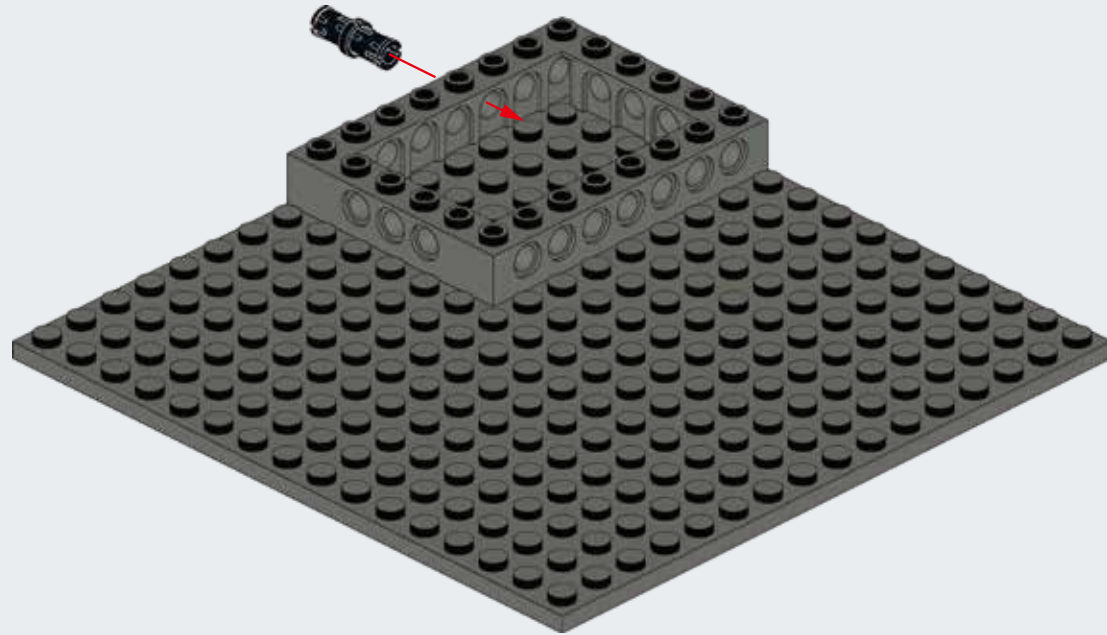

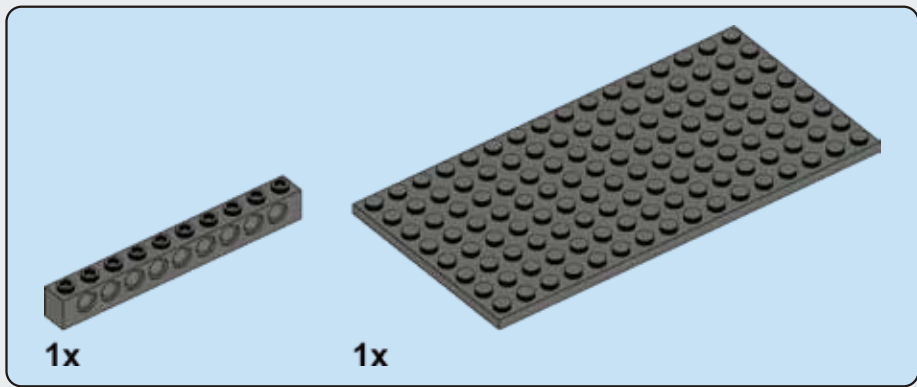

**D2**

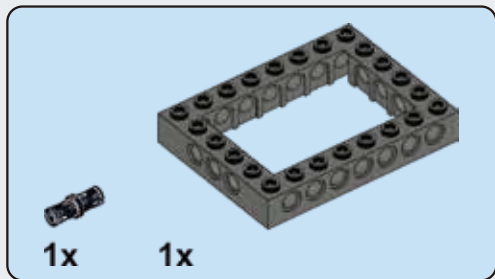
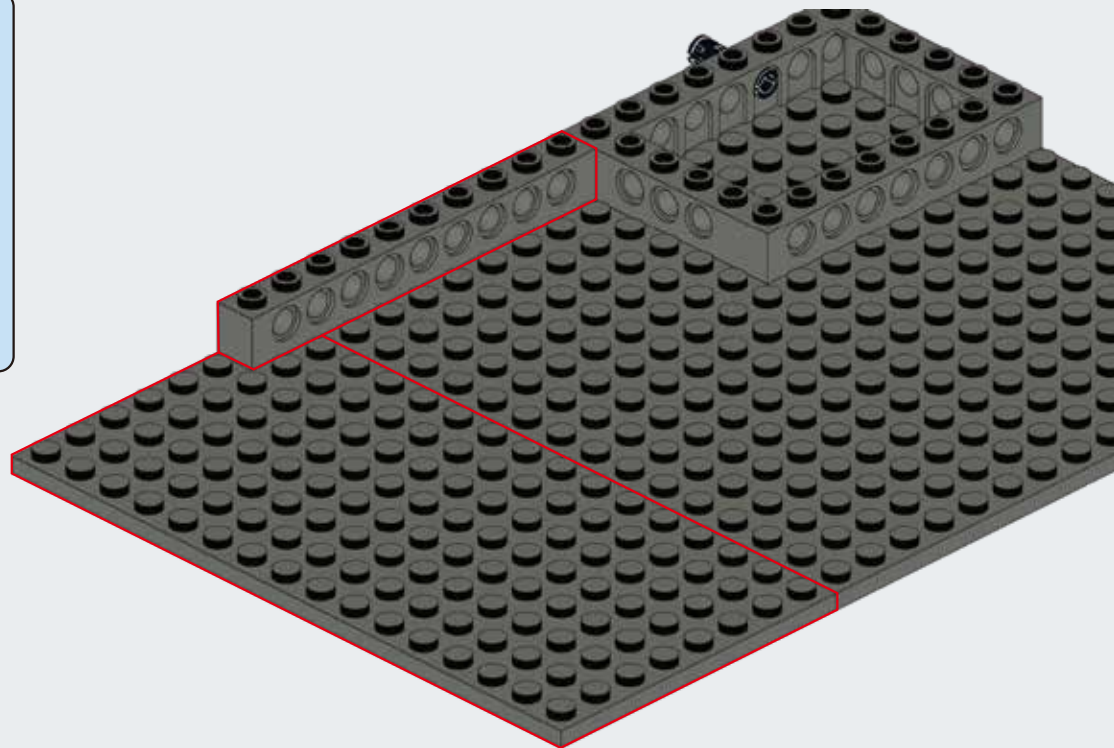

**D3**

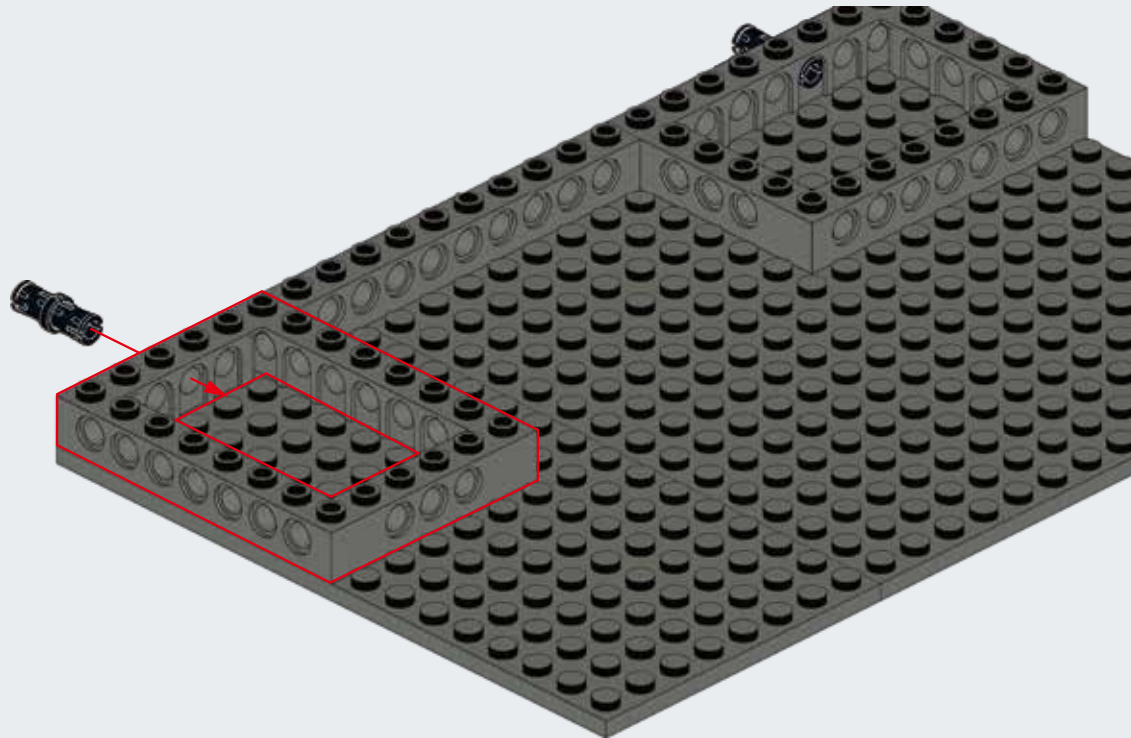

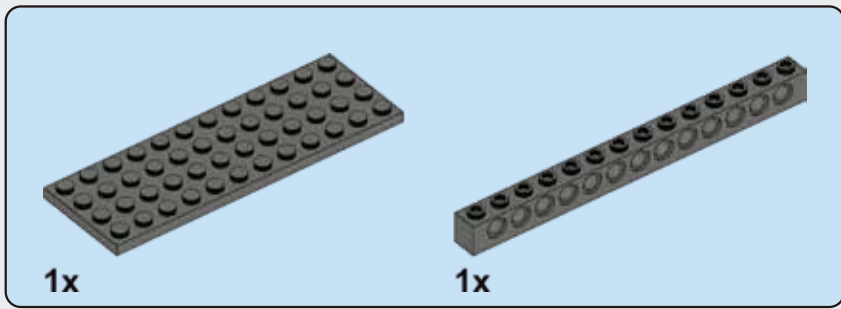

**D4**

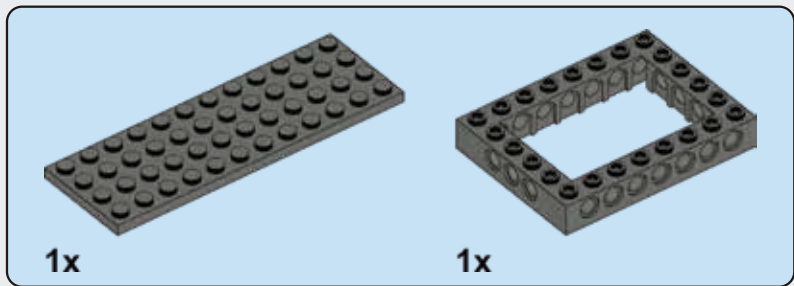
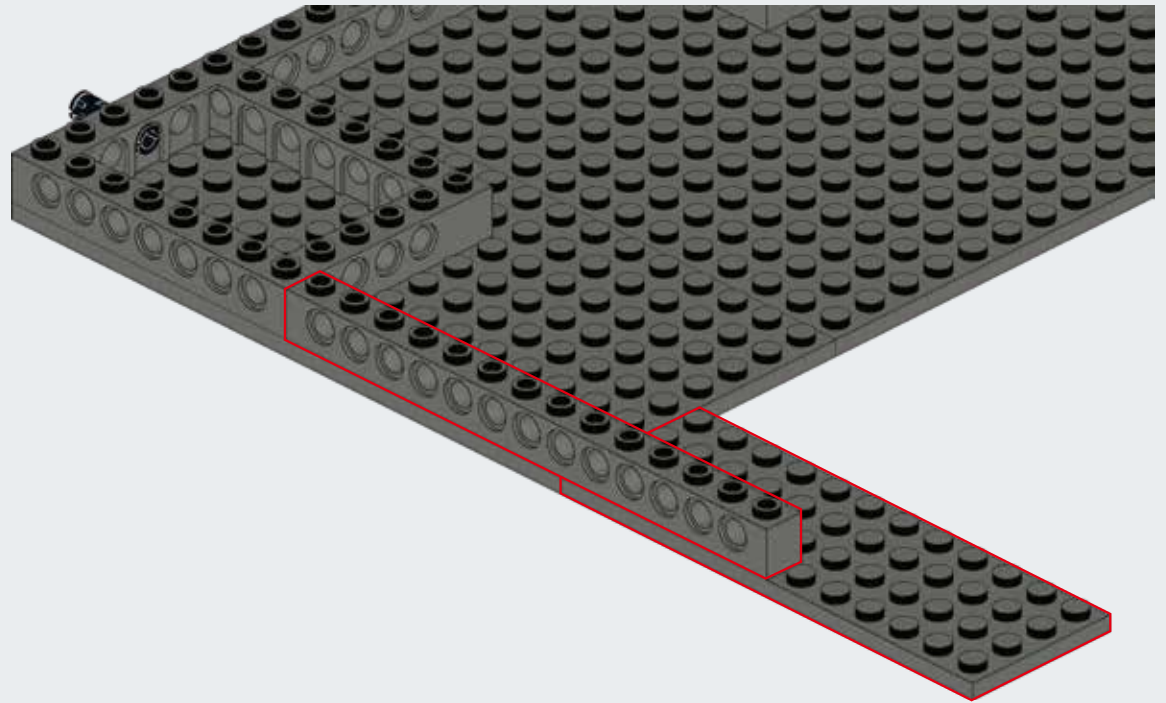

**D5**

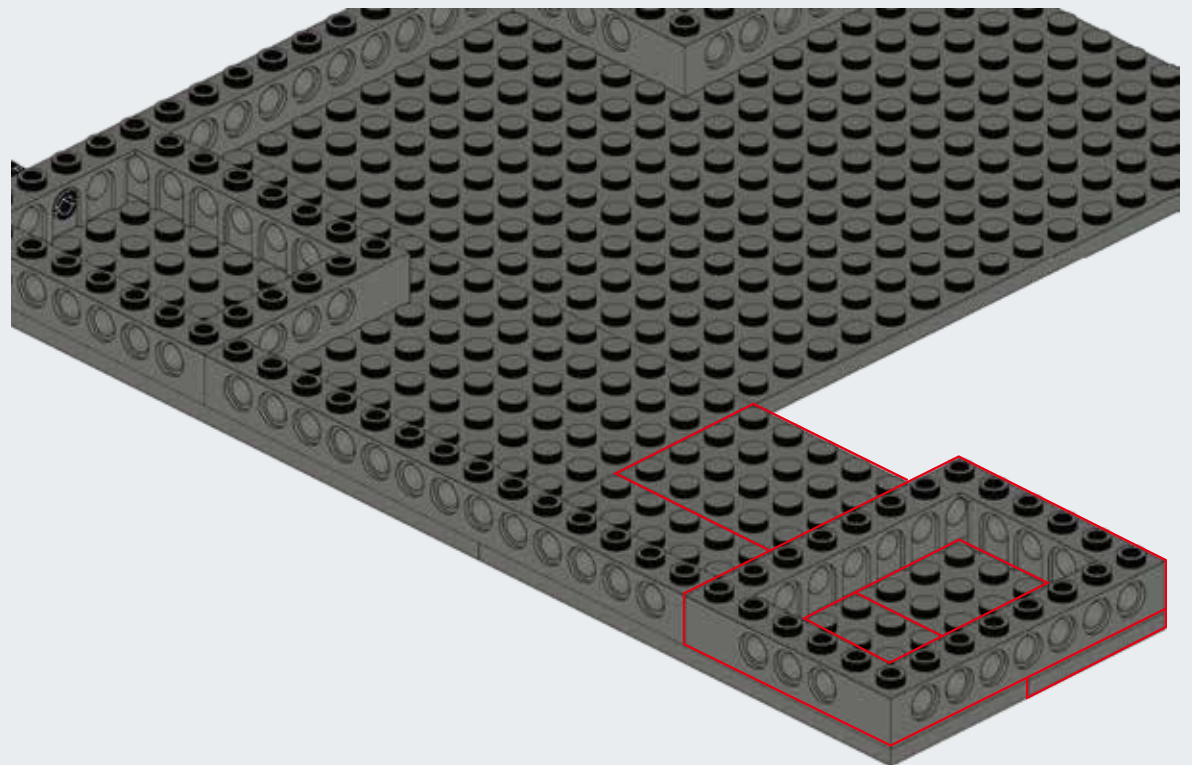

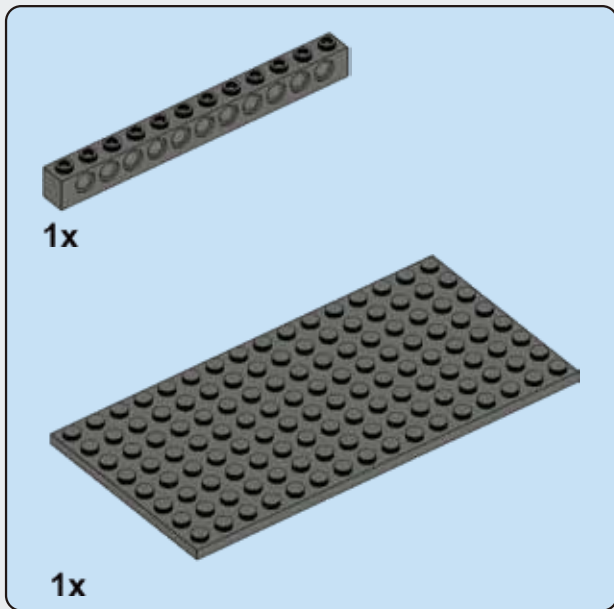

**D6**

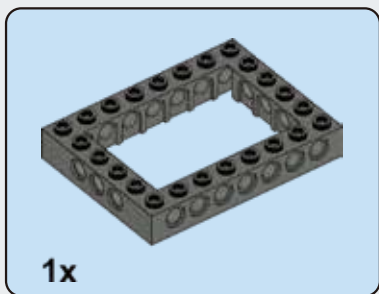
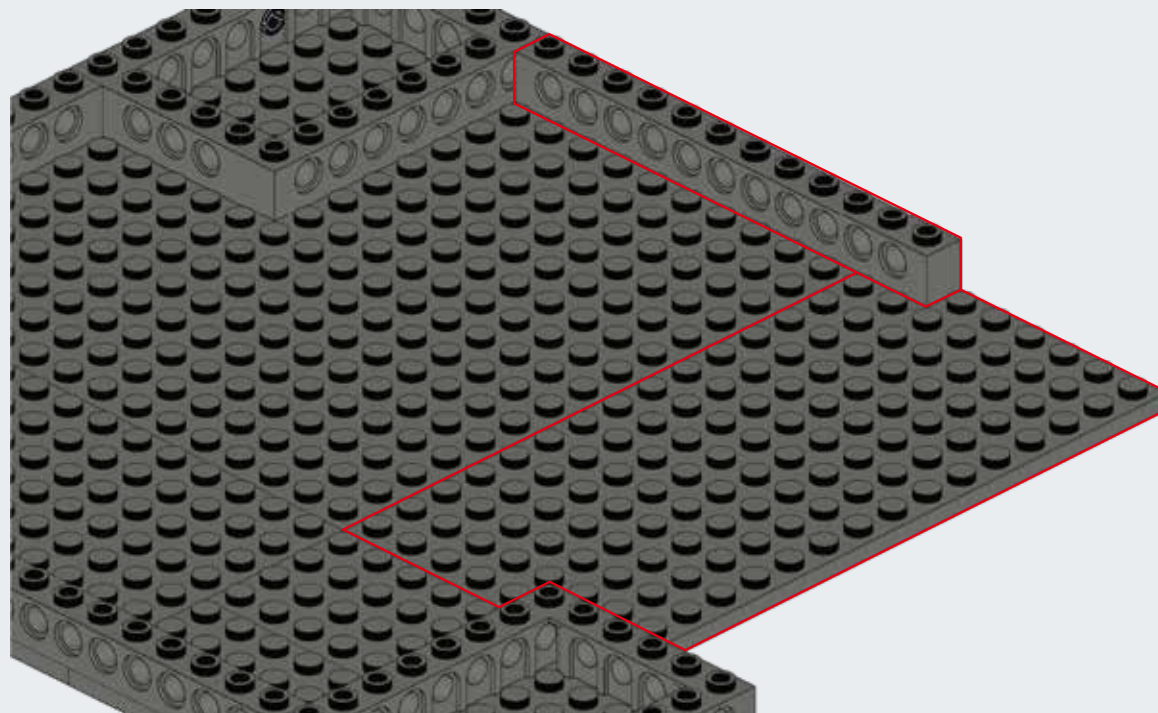

**D7**

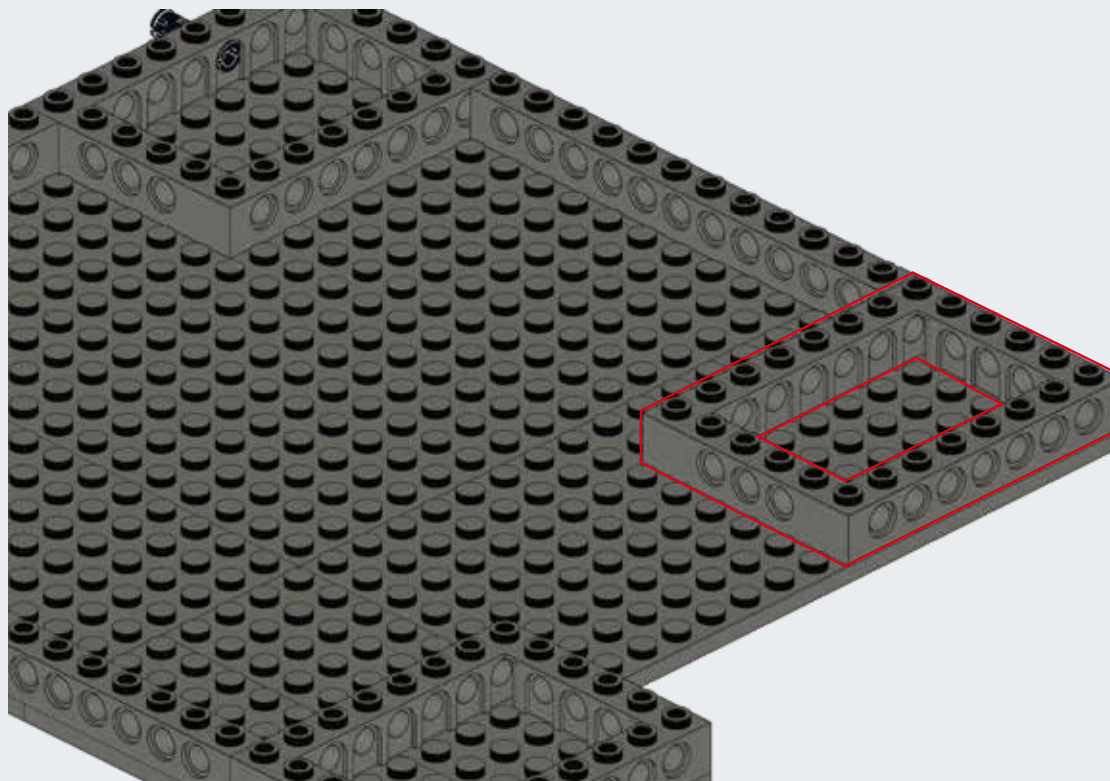

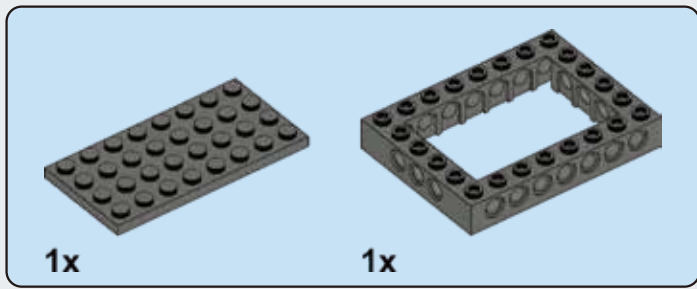

**D8**

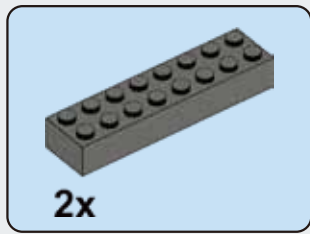
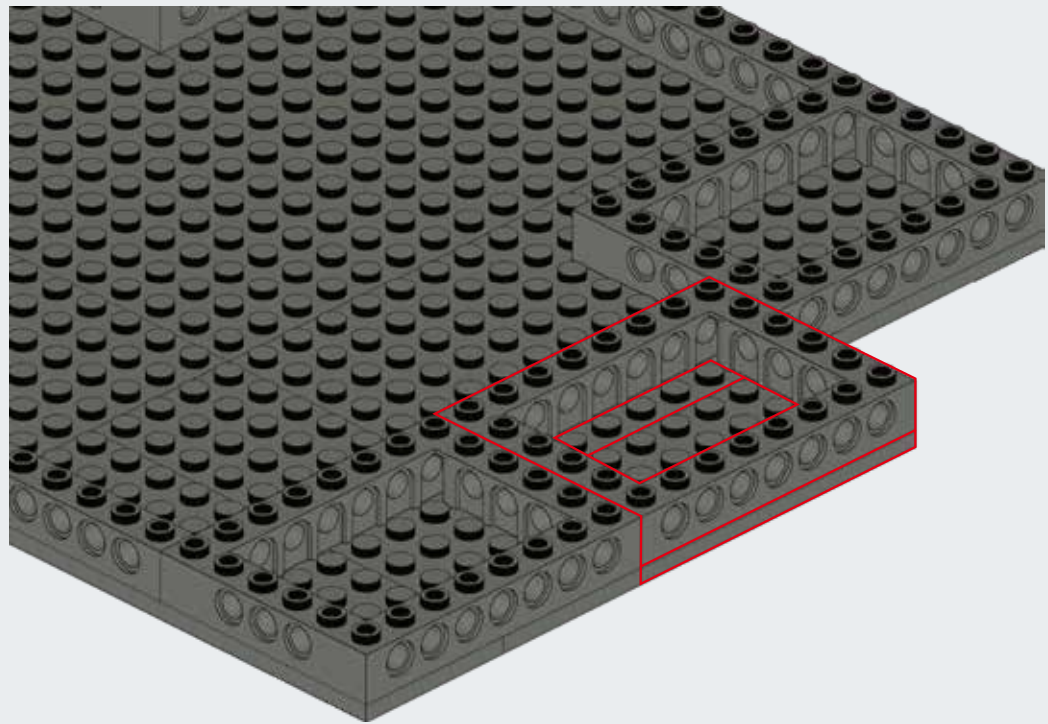

**D9**

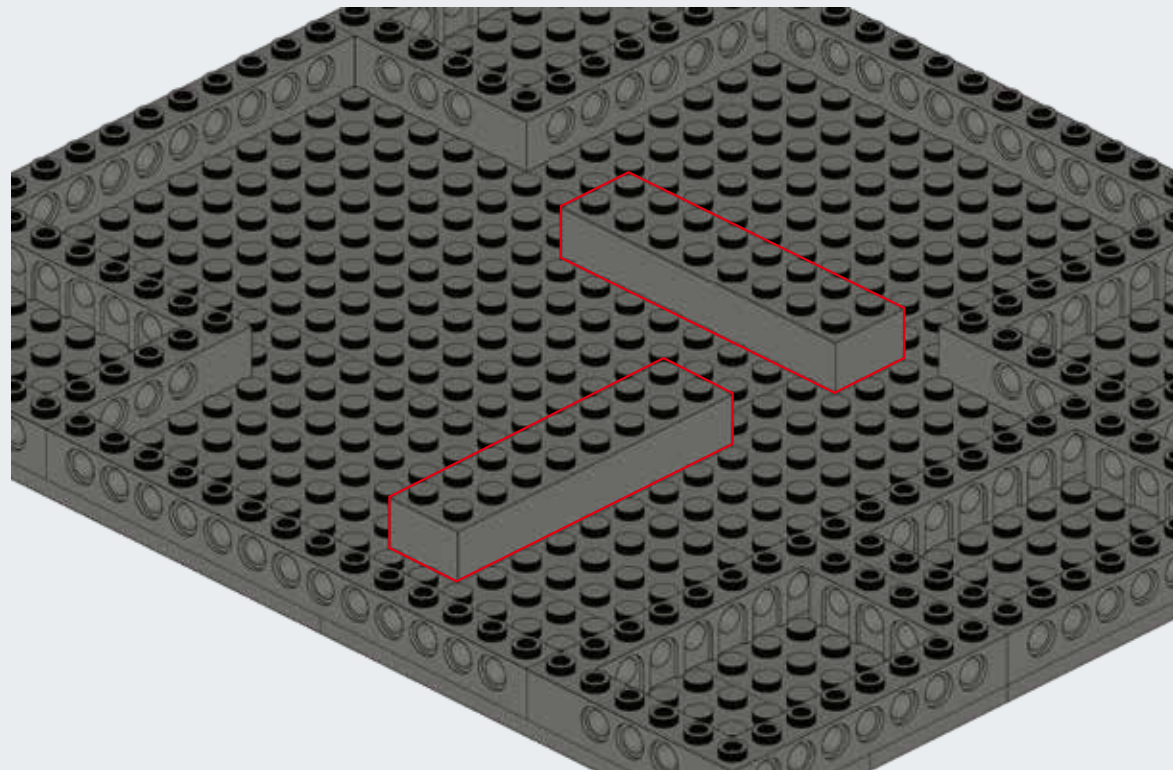

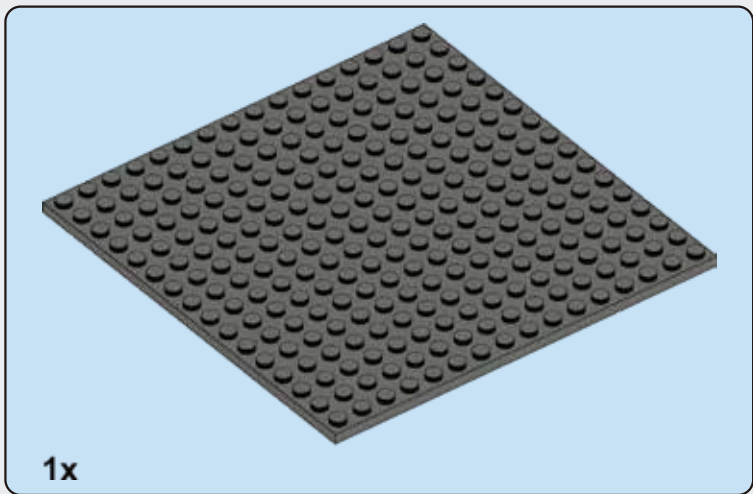

**D10**

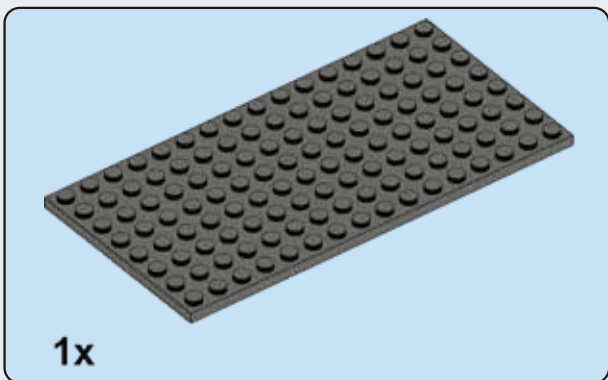
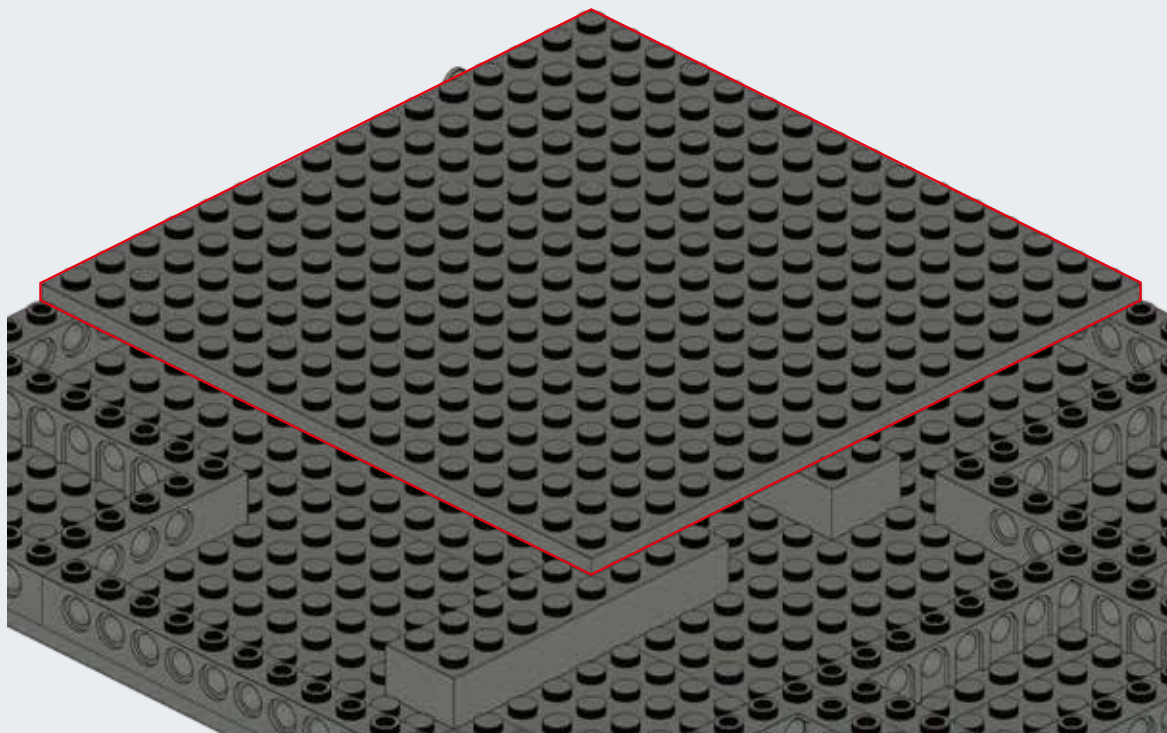

**D11**

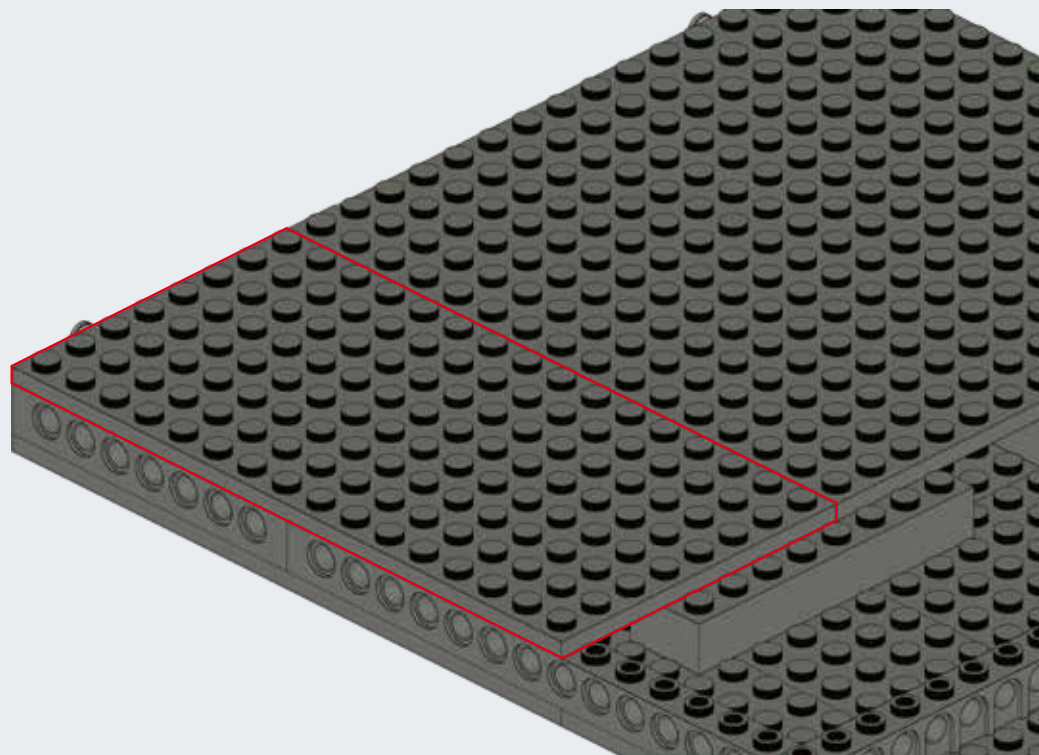

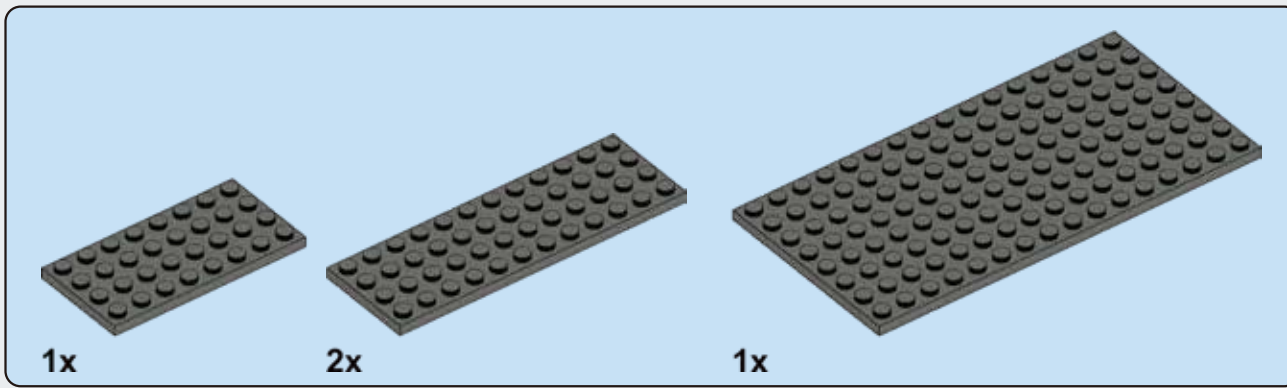

## D12

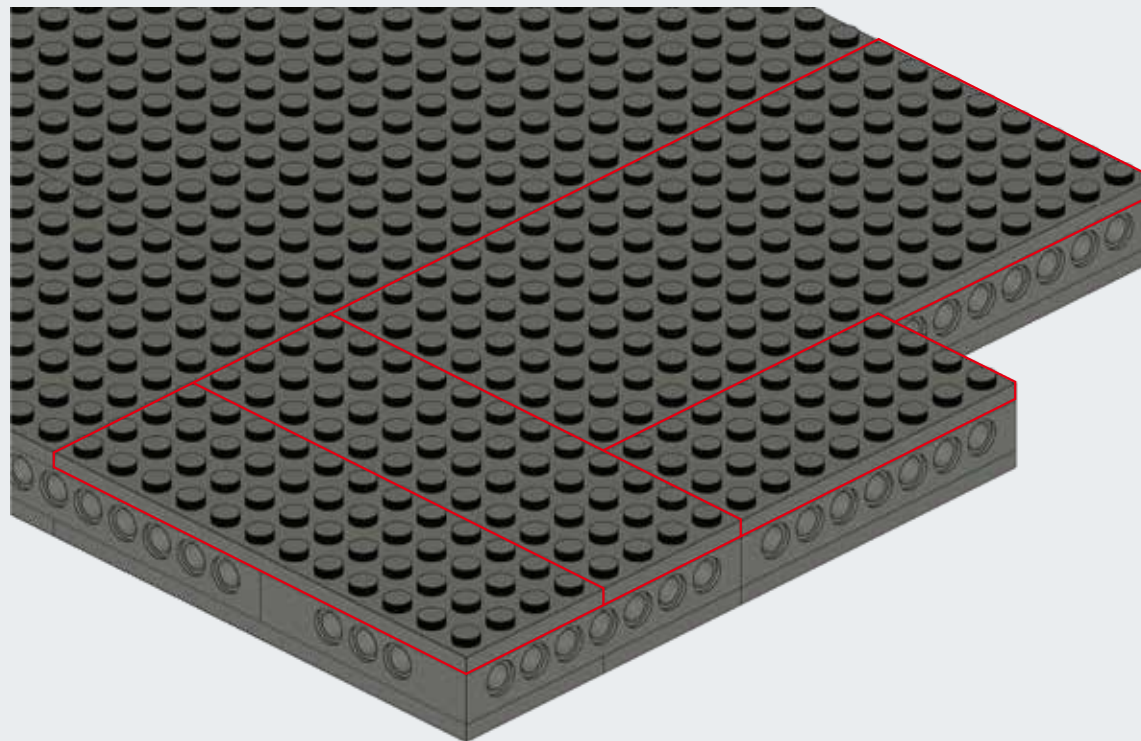

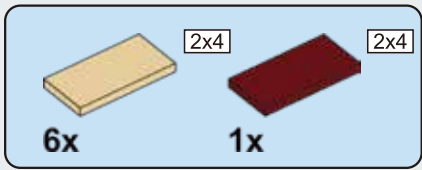

**D13**

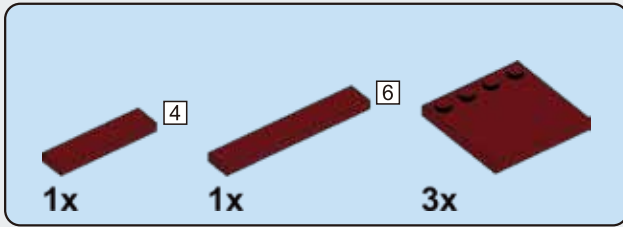
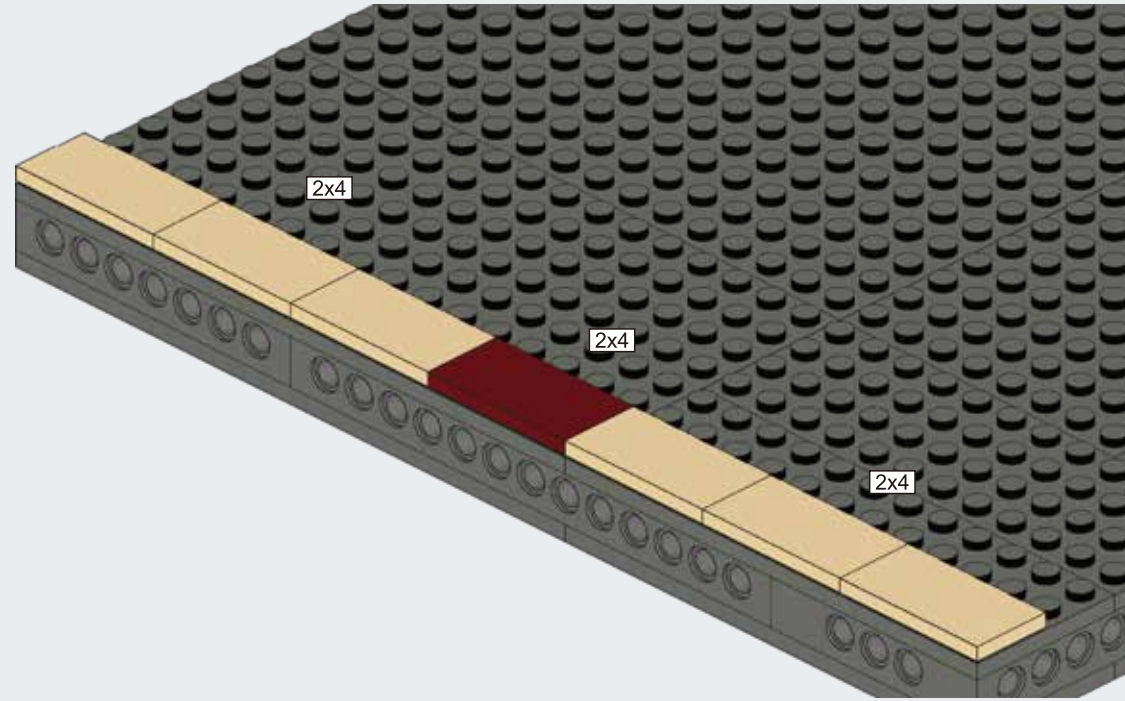

**D14**

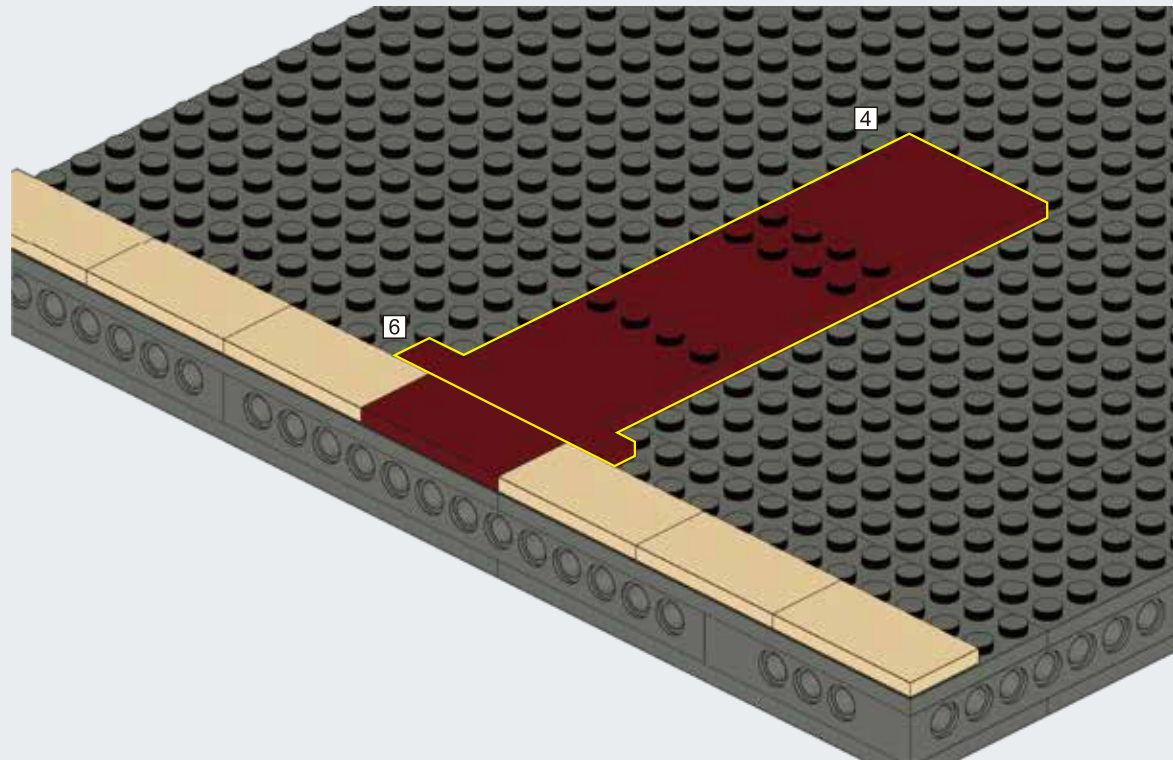



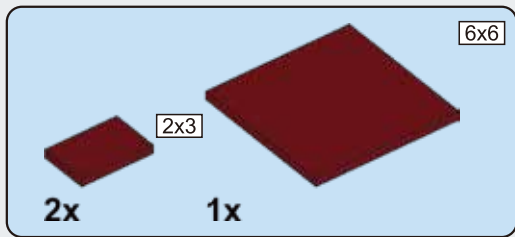

## D15

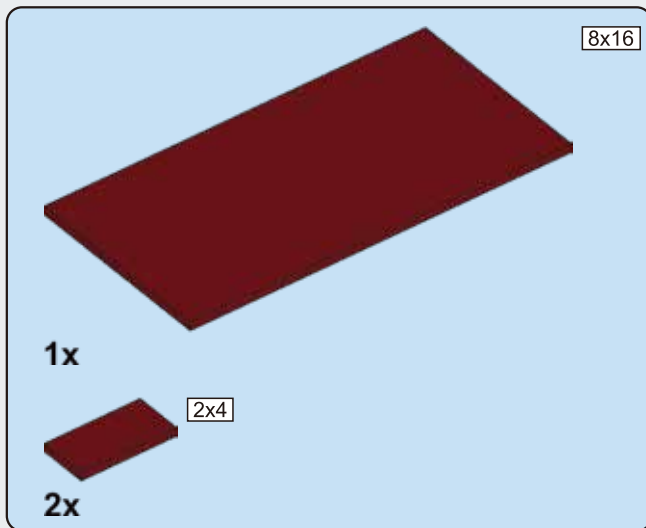
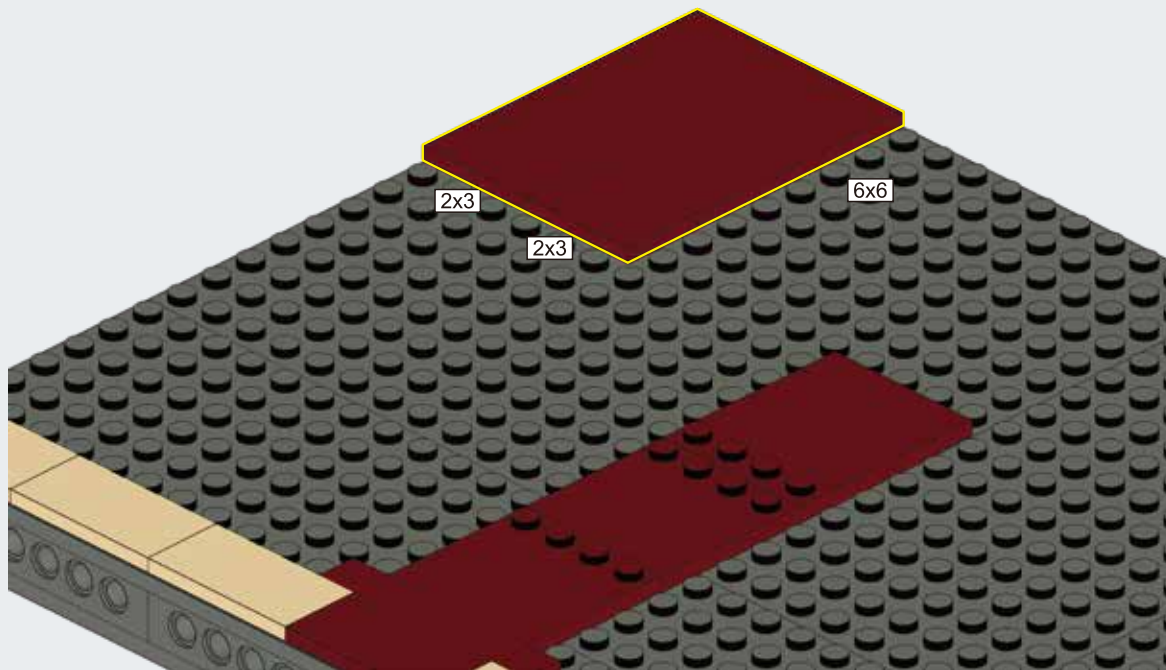

## D16

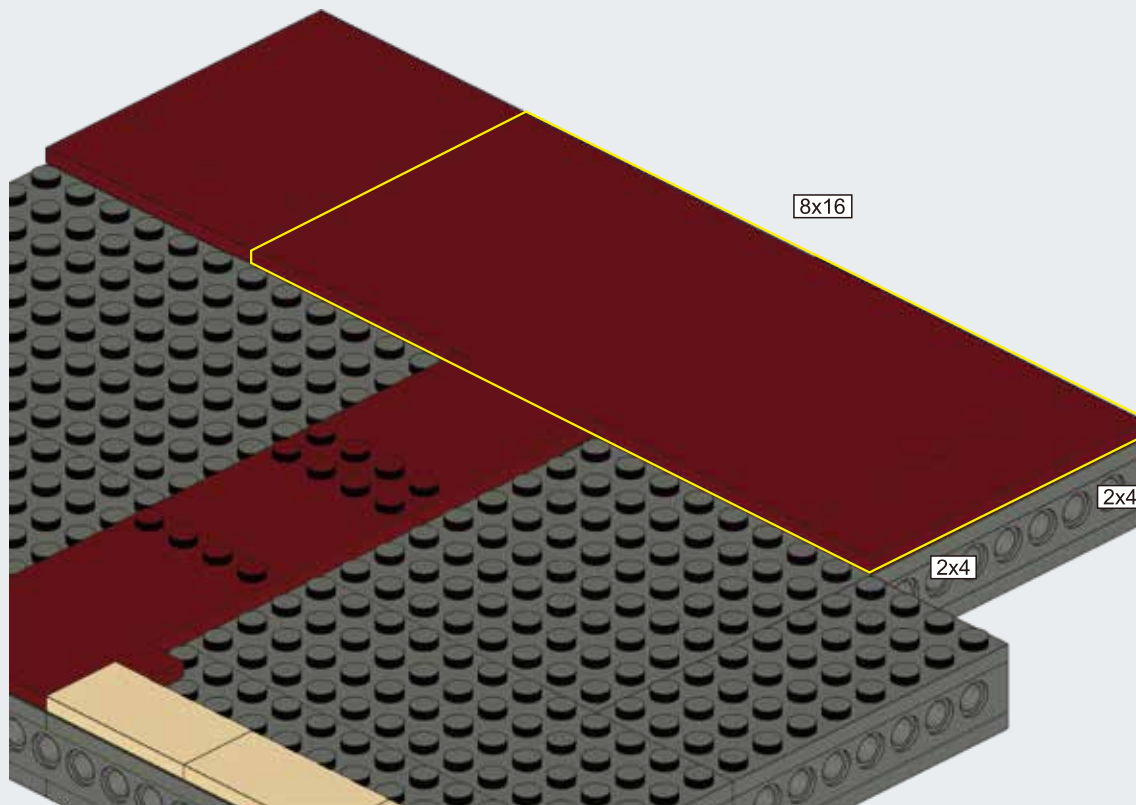

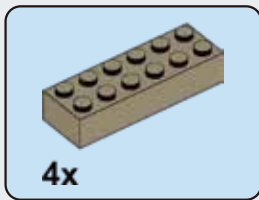

# D17

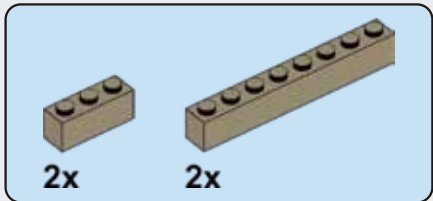
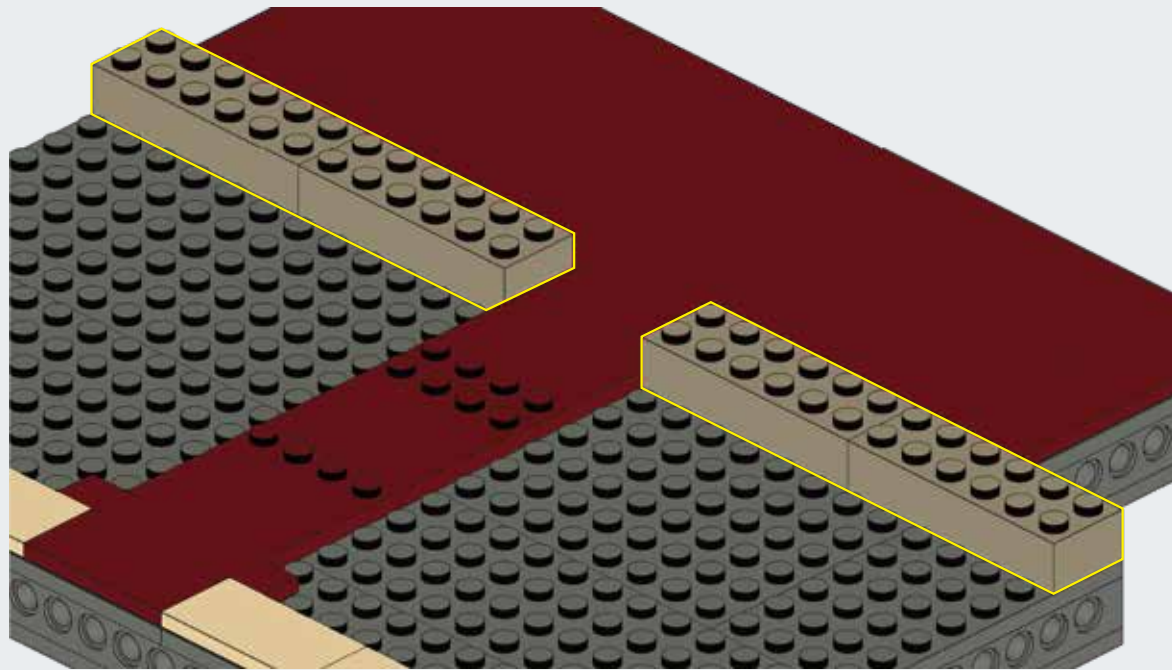

# D18

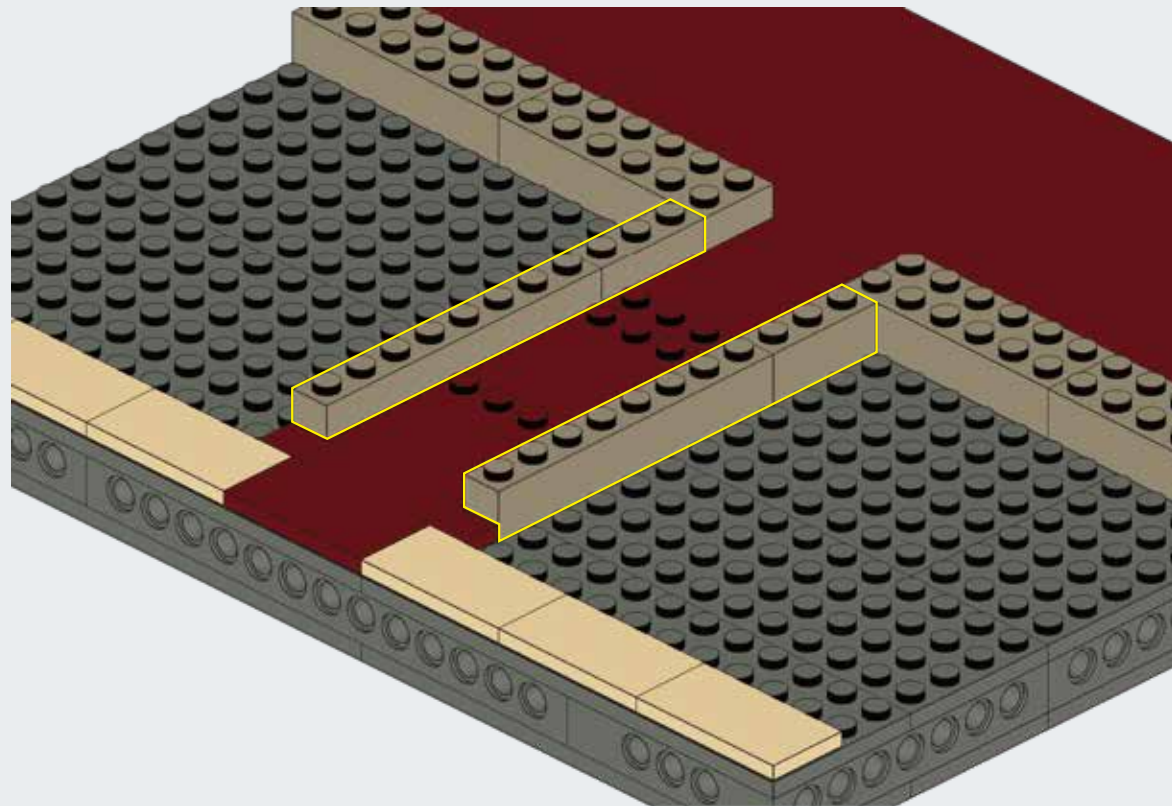

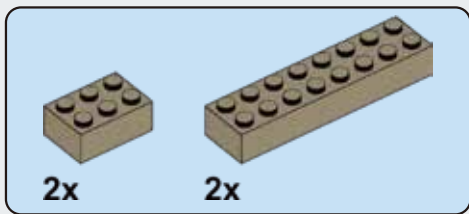

**D19**

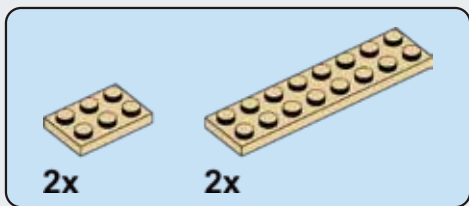
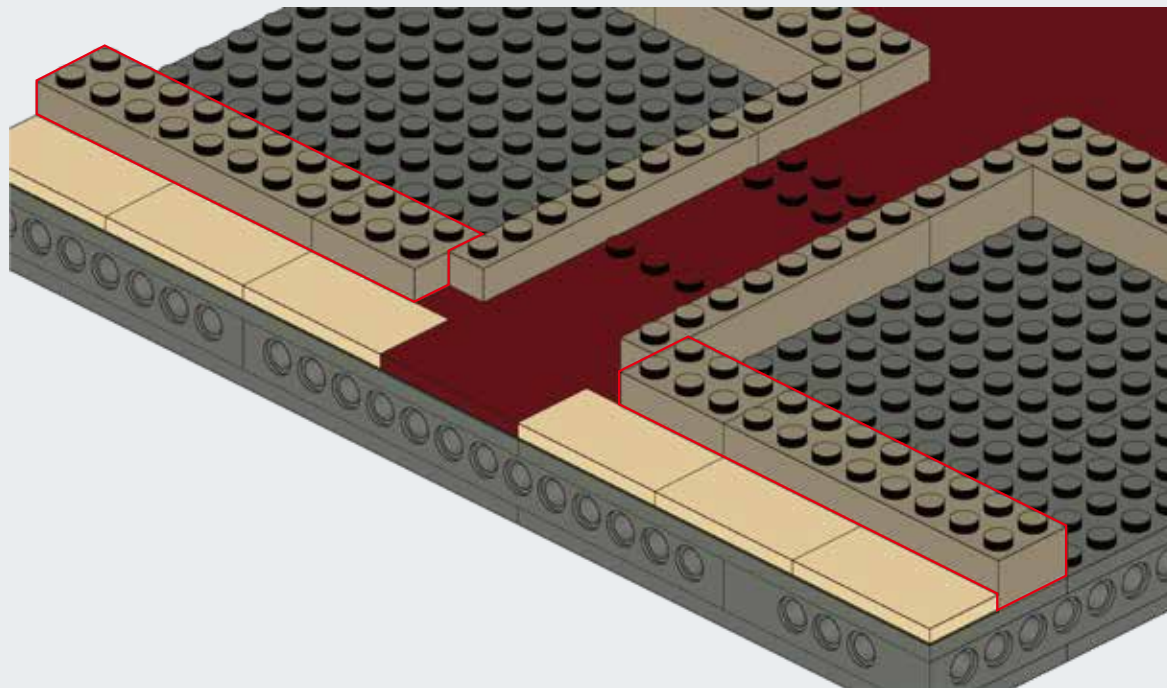

**D20**

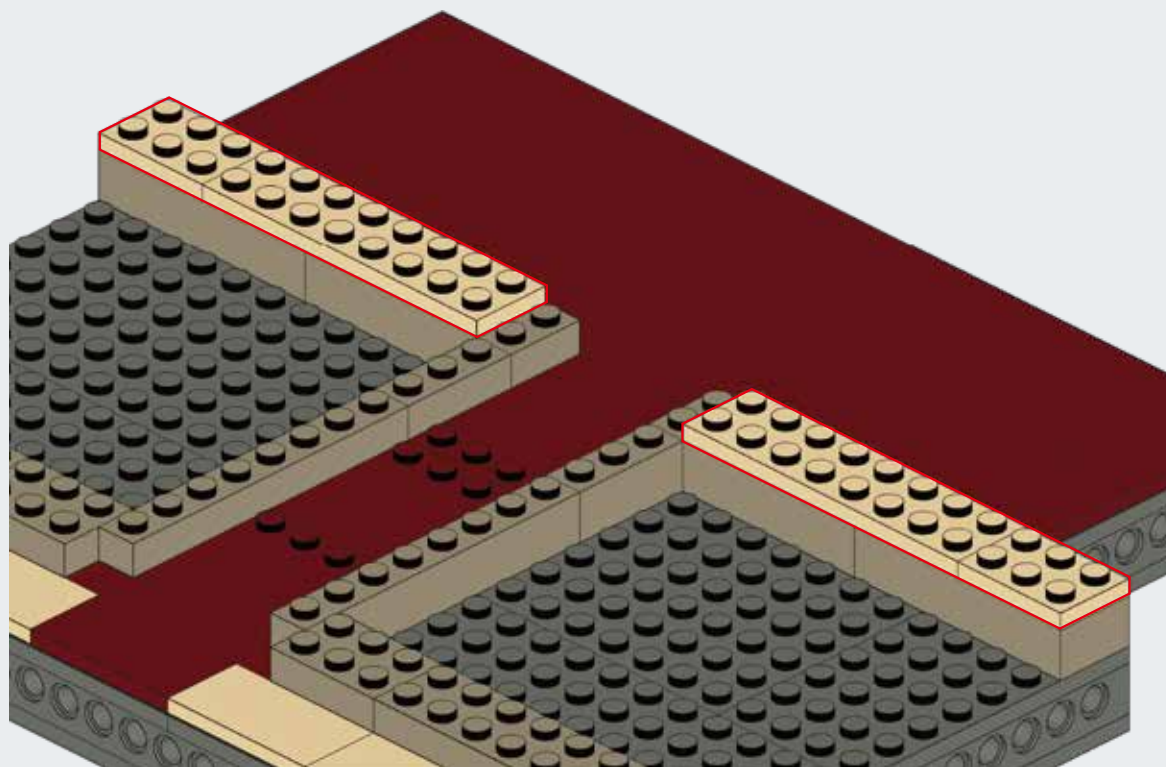

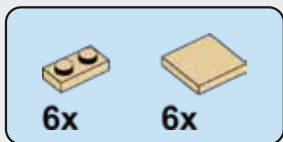

**D21**

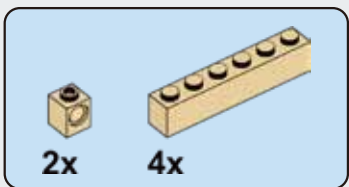
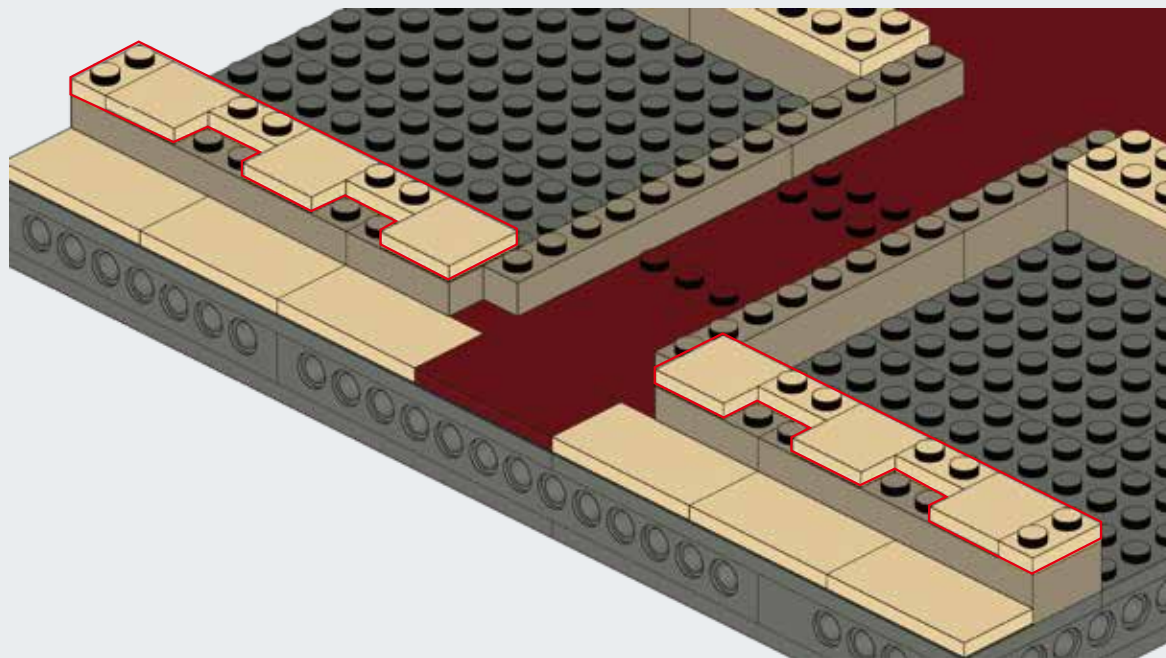

**D22**

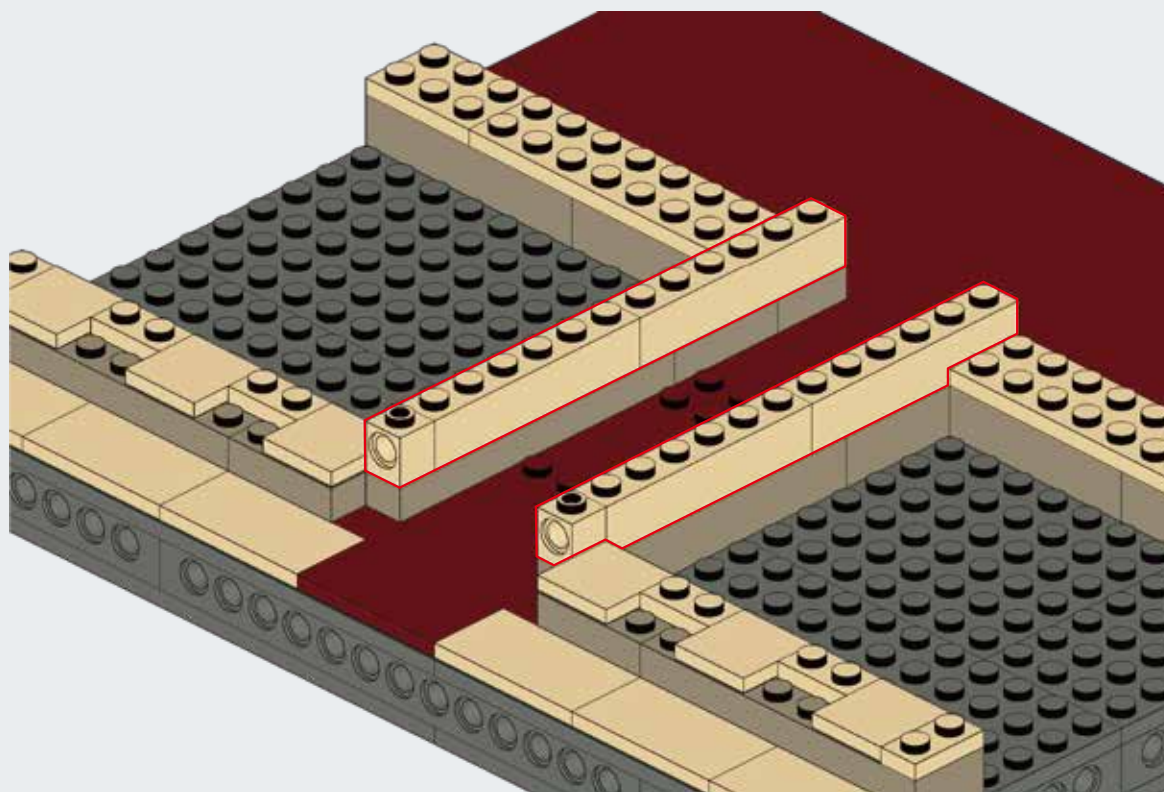

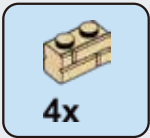

# D23

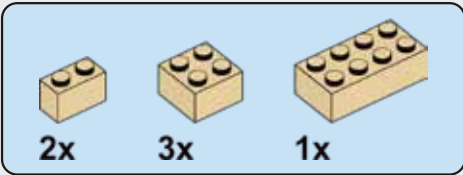
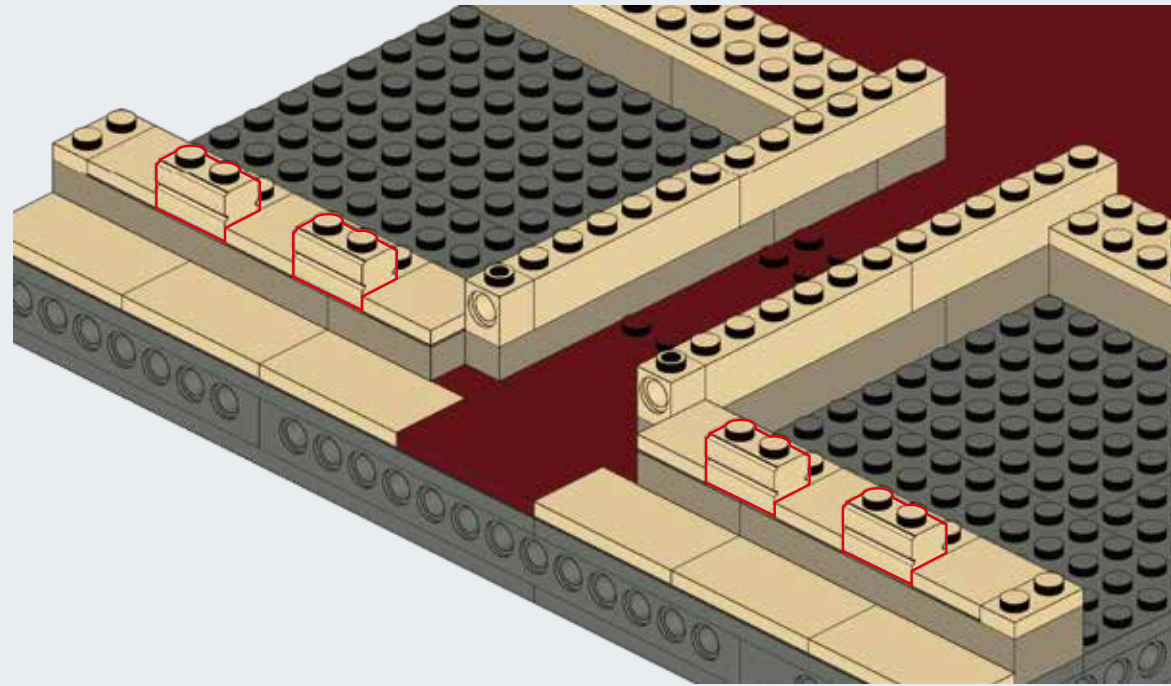

# D24

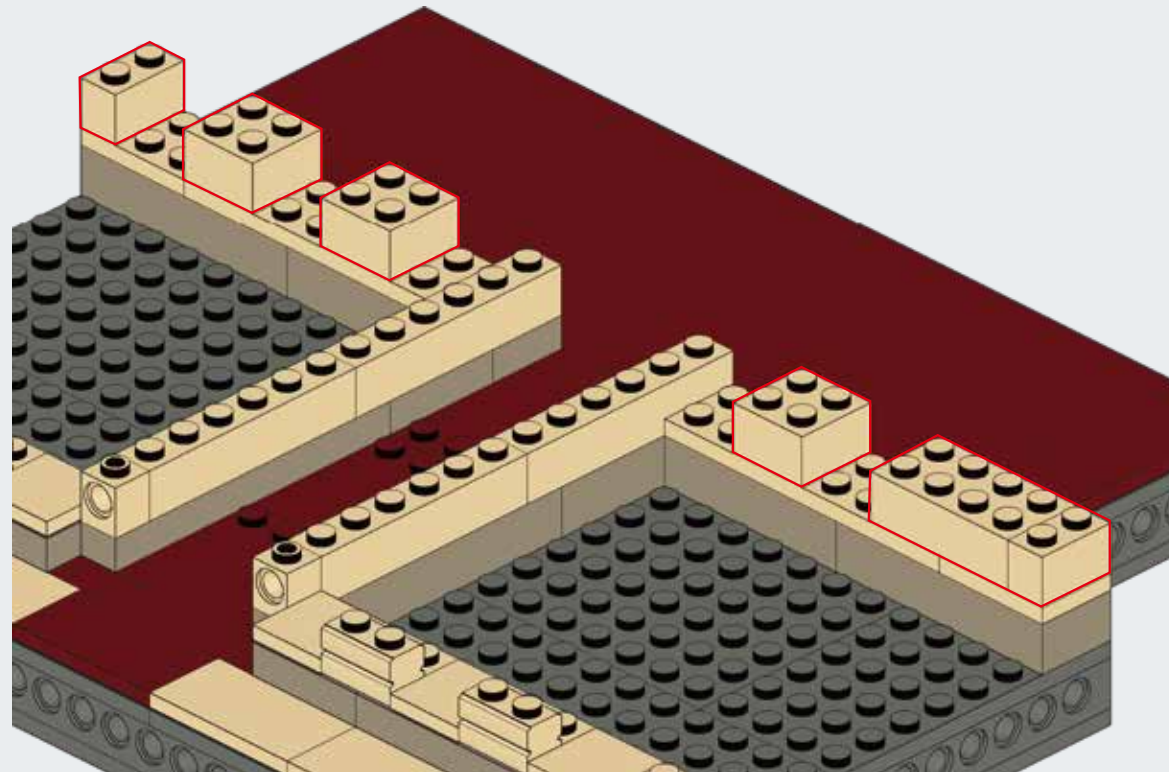

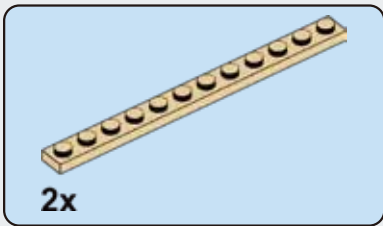

**D25**

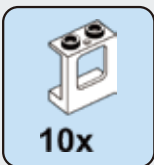
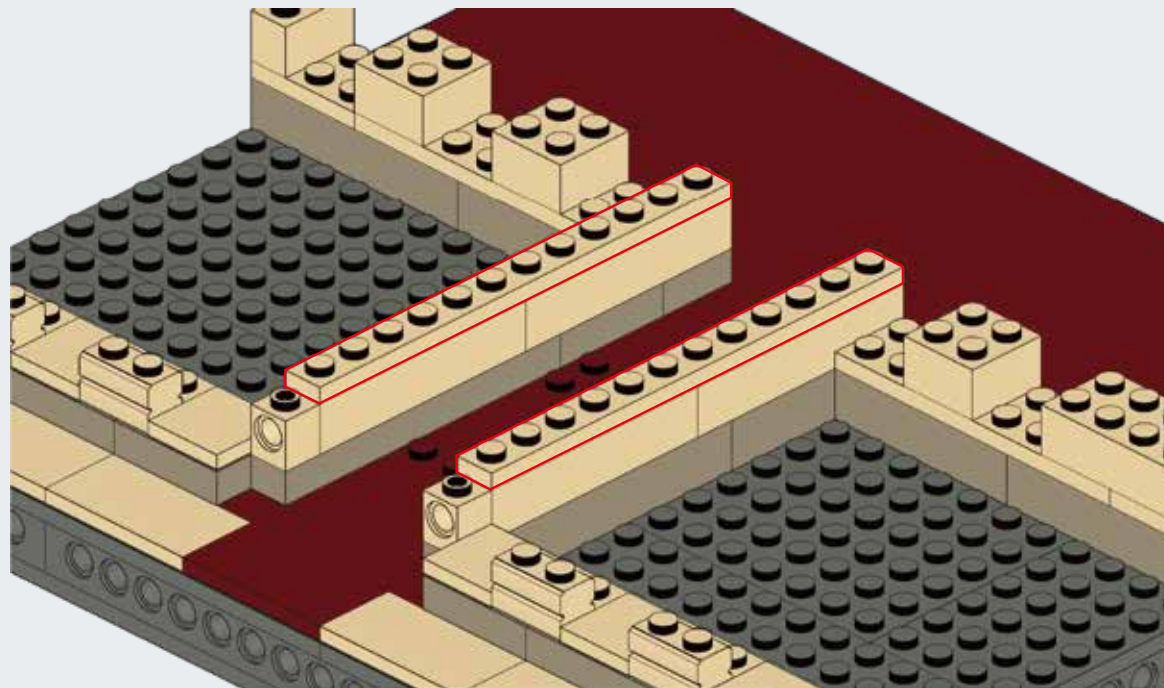

**D26**

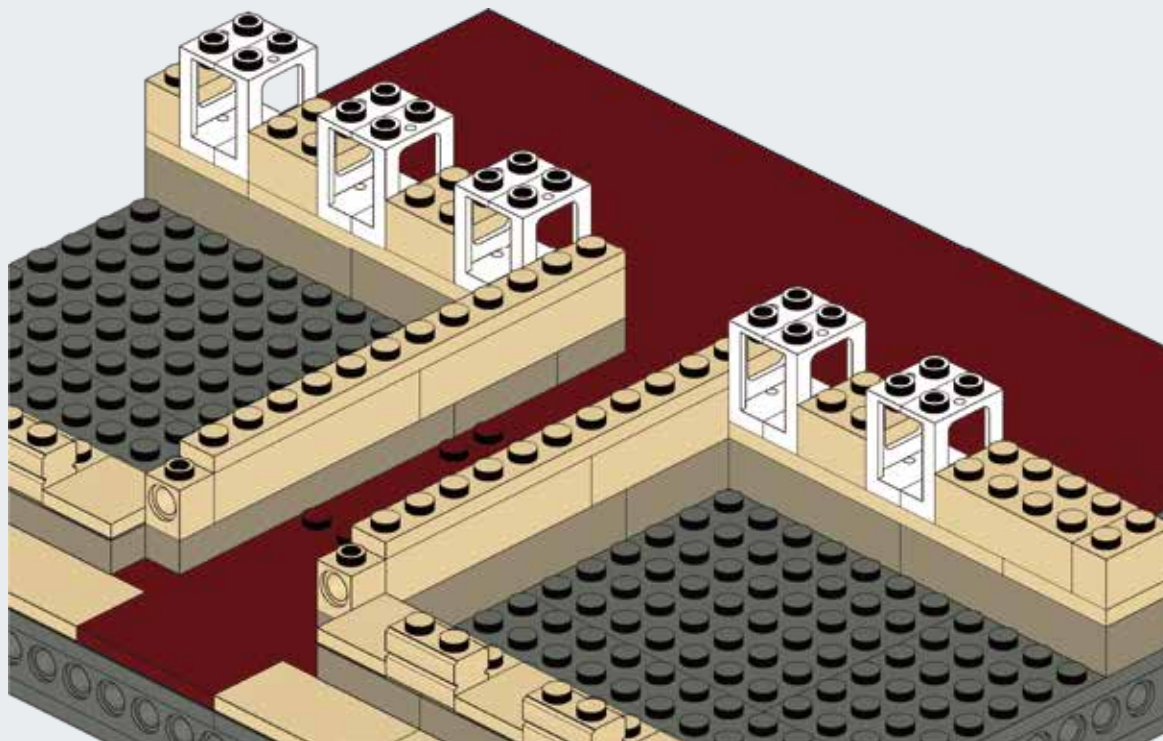

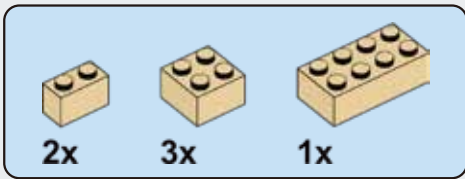

## D27

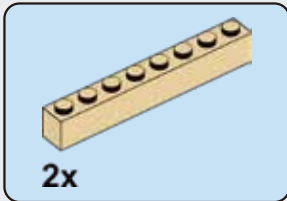
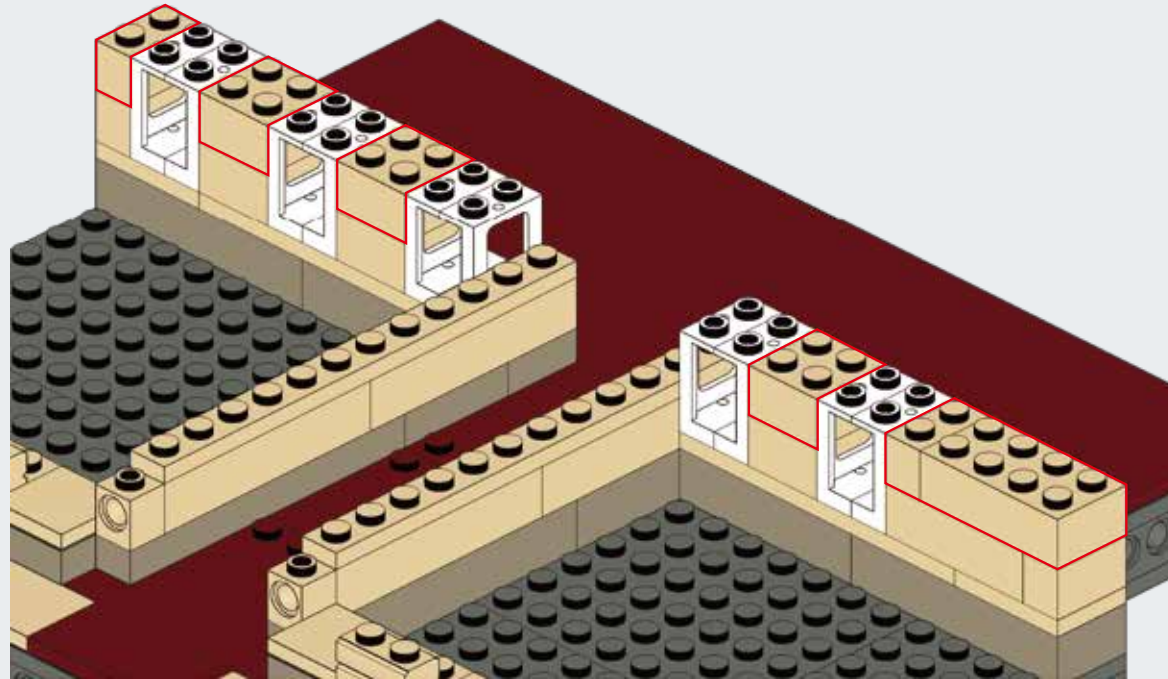

## D28

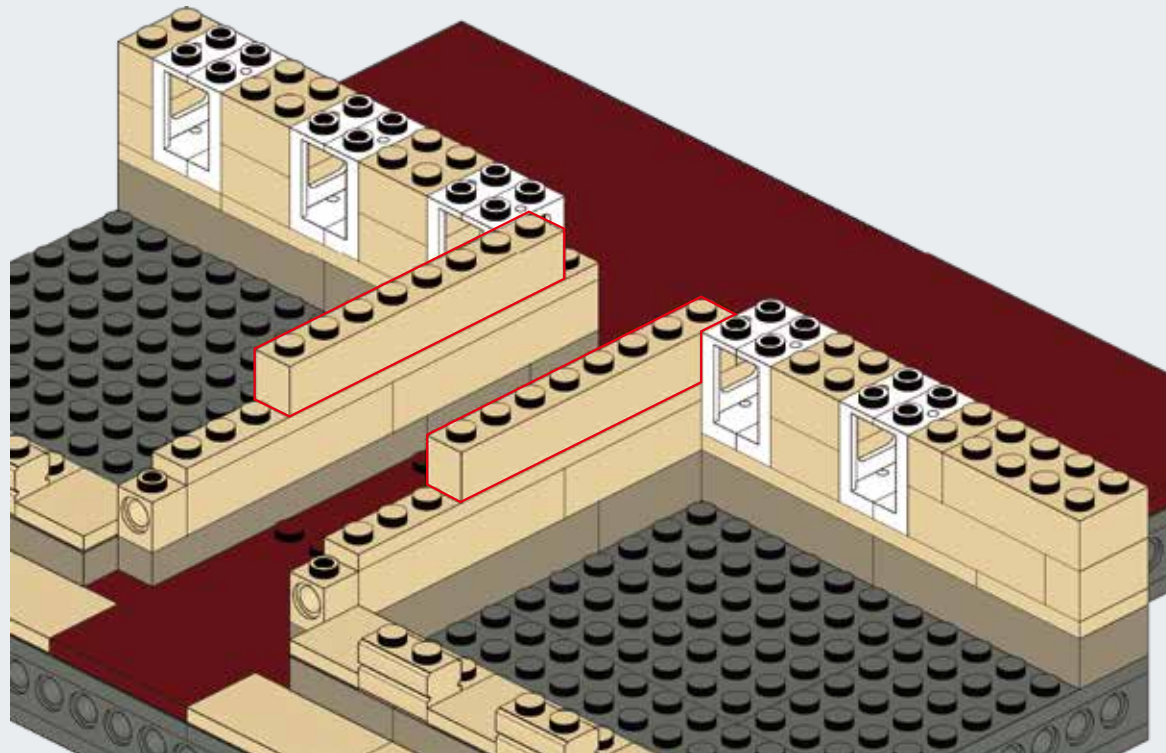

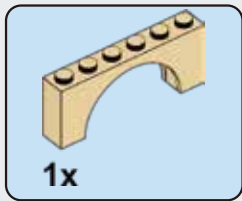

**D29**

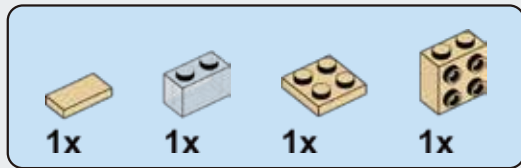
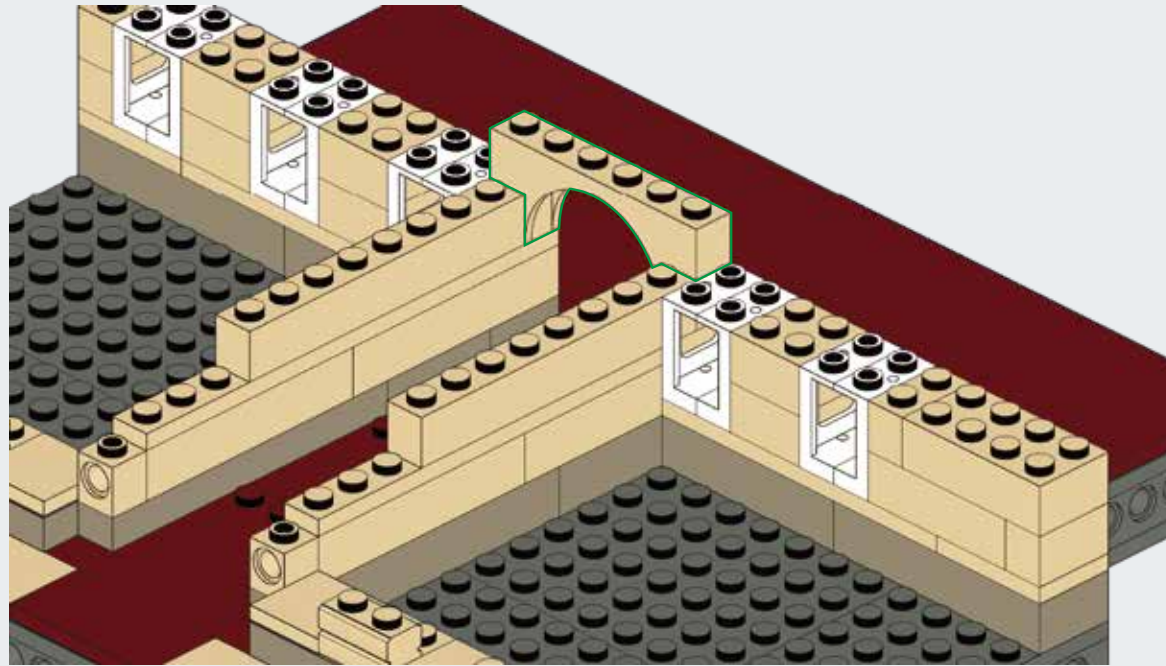

**D30**

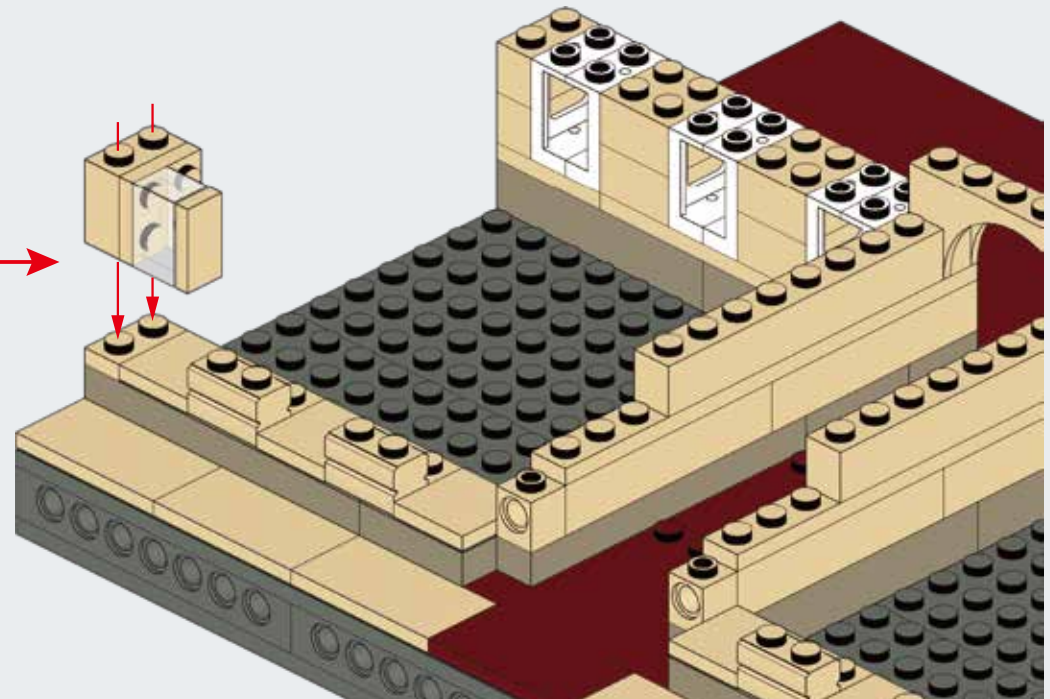
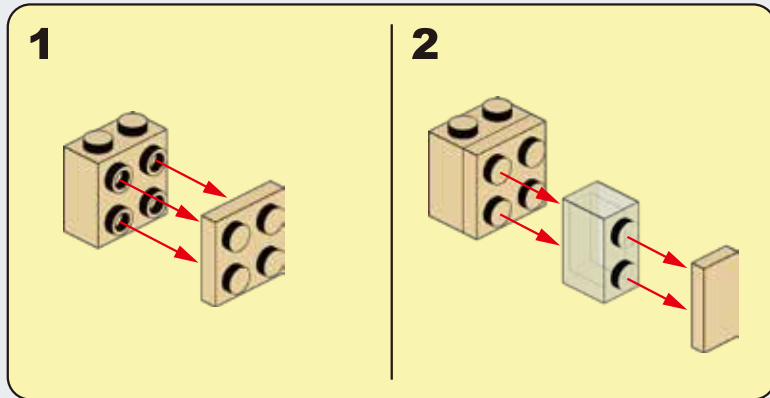



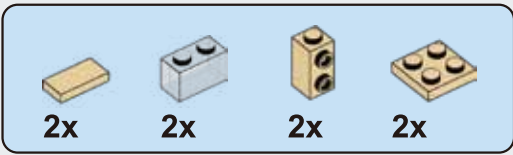

### D31

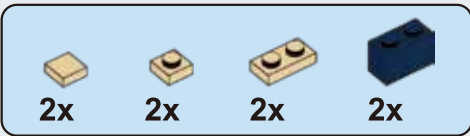
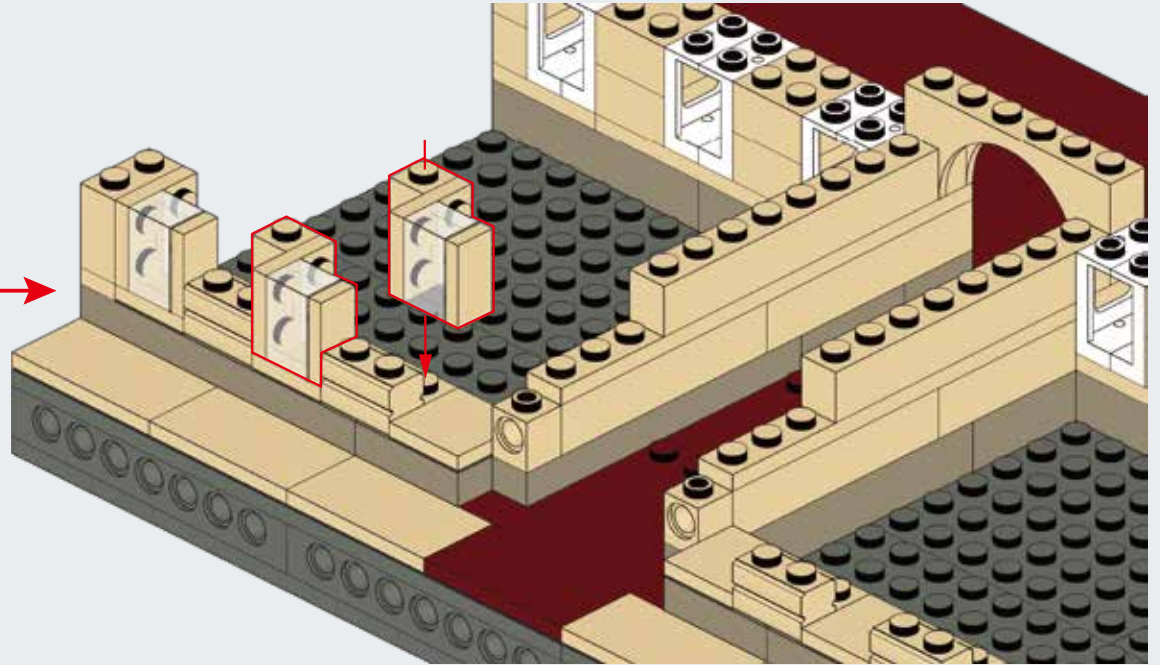
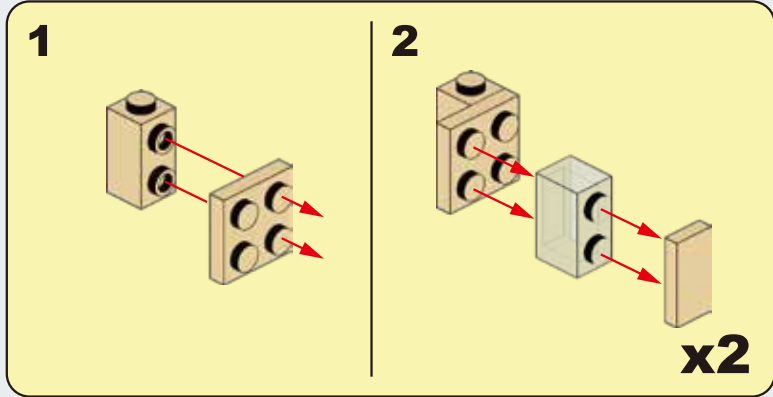

### D32

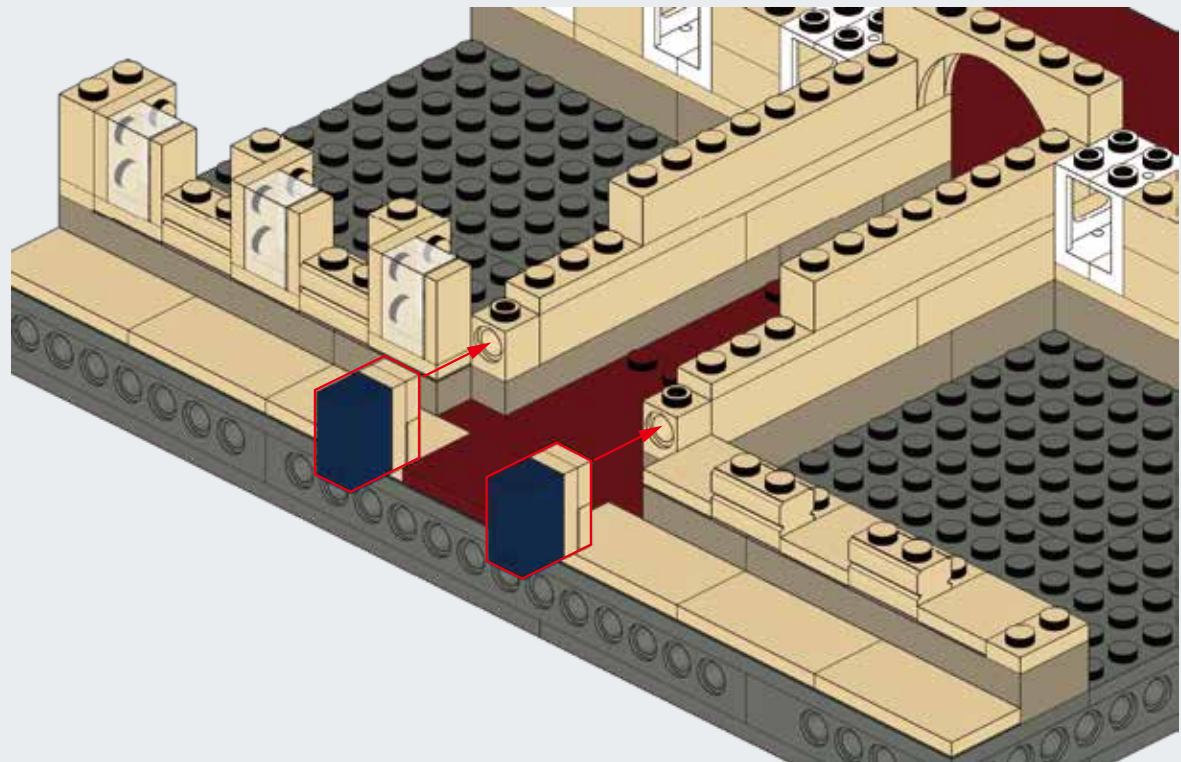
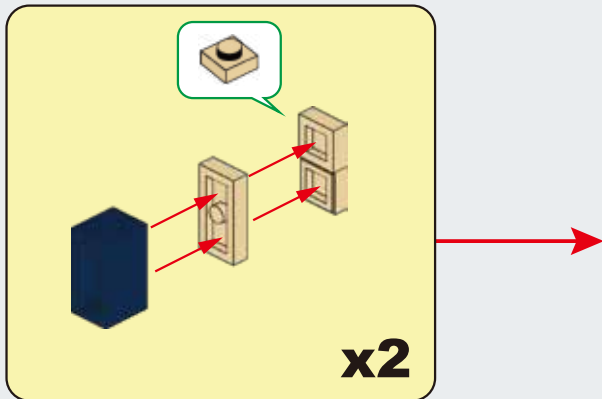



**D33**

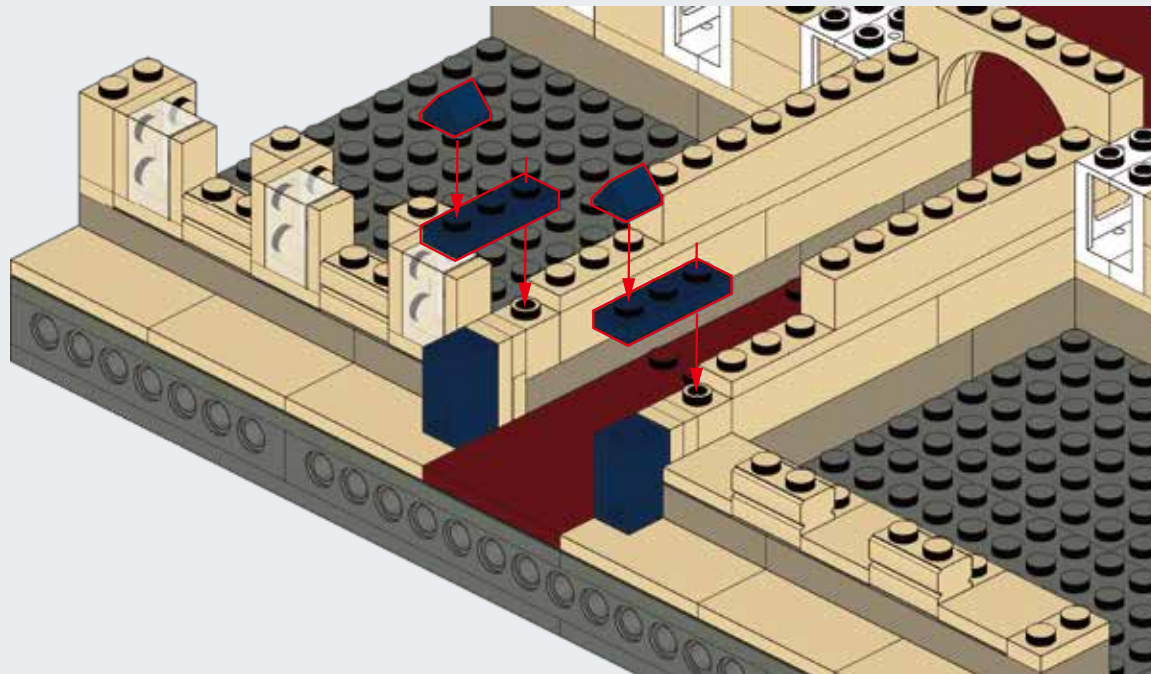

**D34**

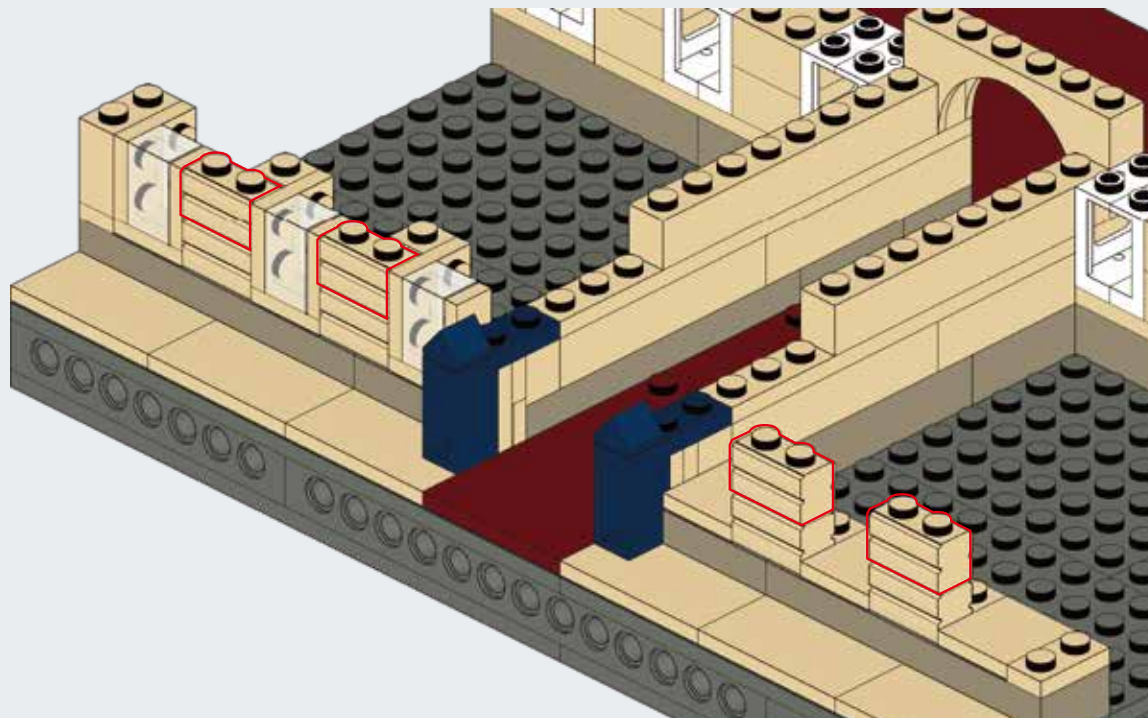

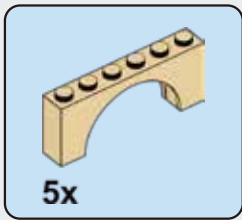

**D35**

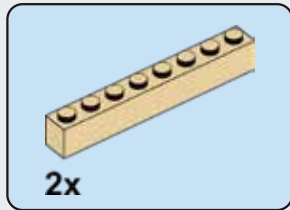
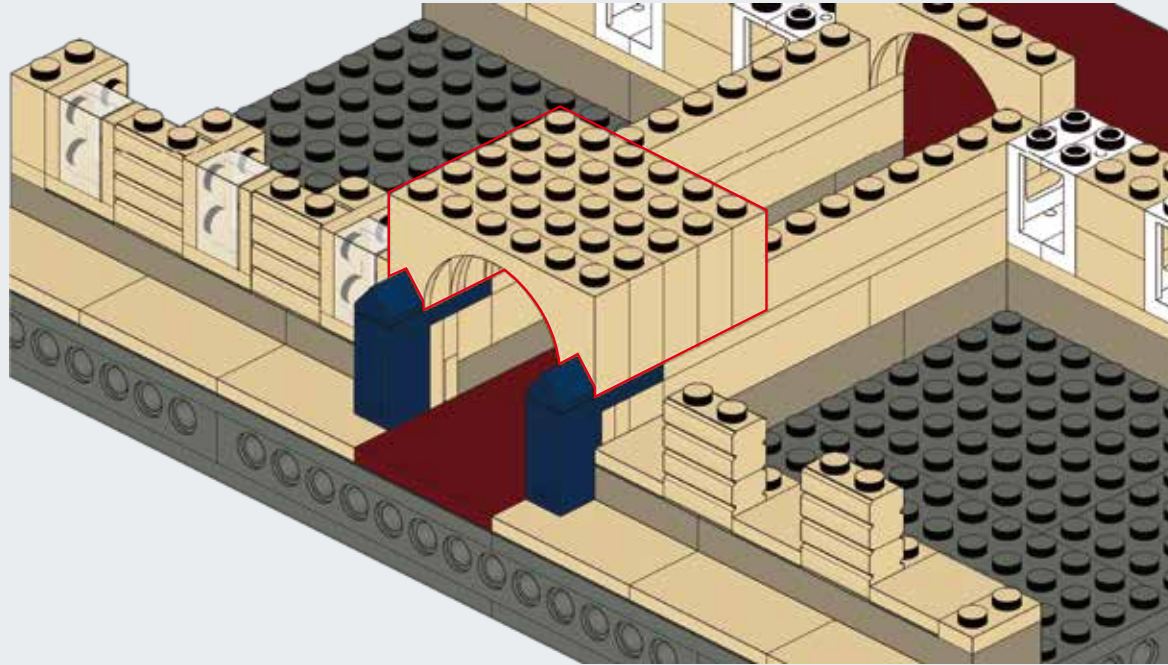

**D36**

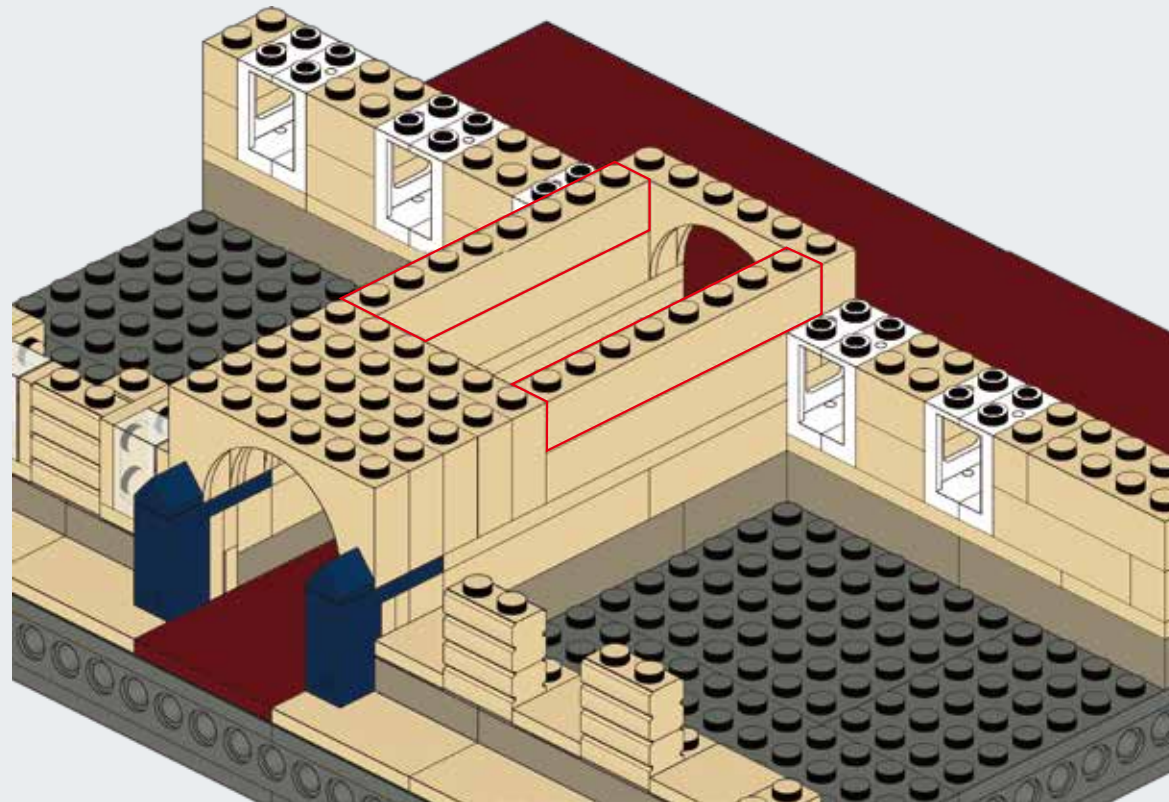

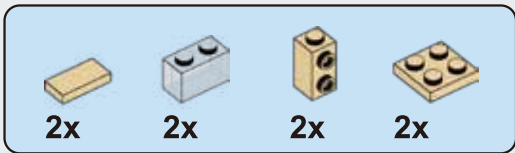

### D37

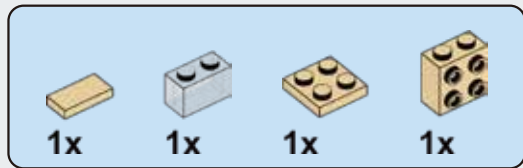
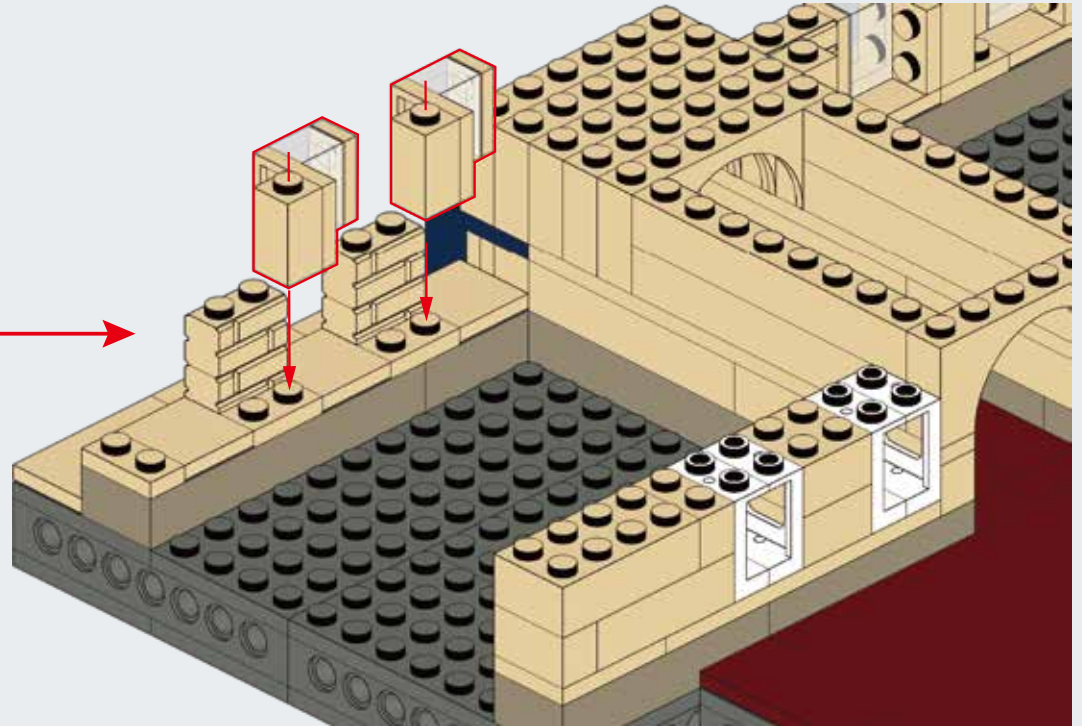
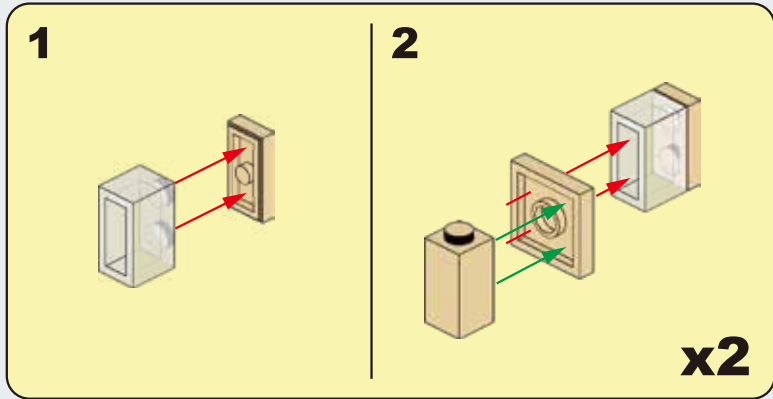

### D38

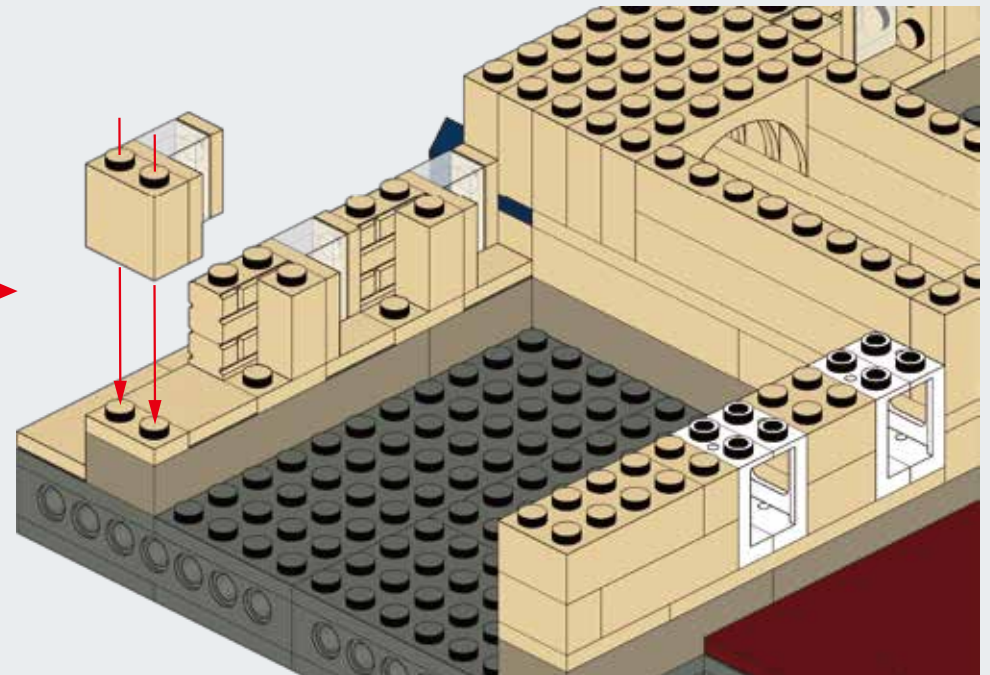
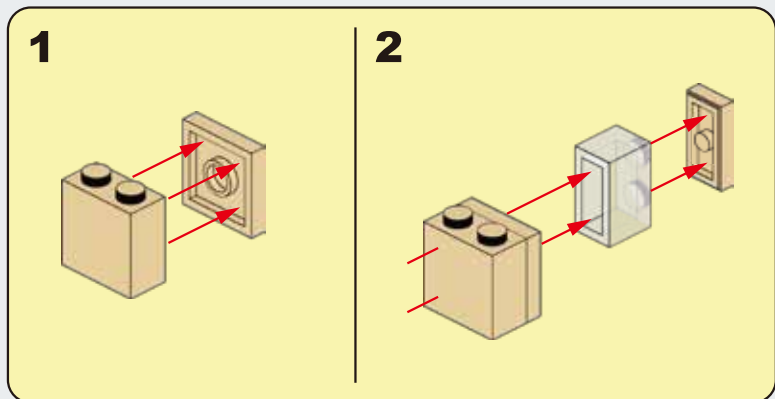

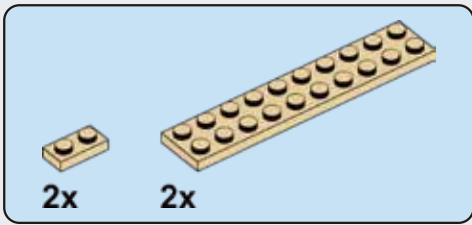

**D39**

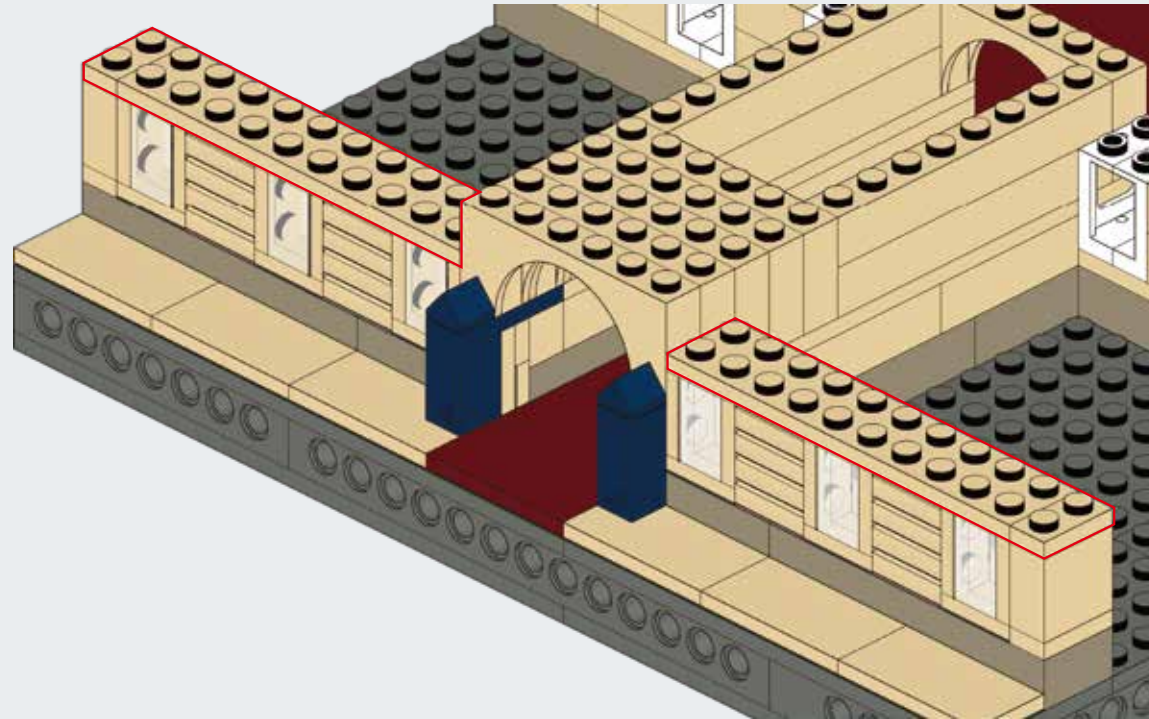
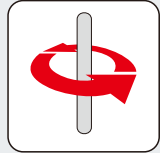

**D40**

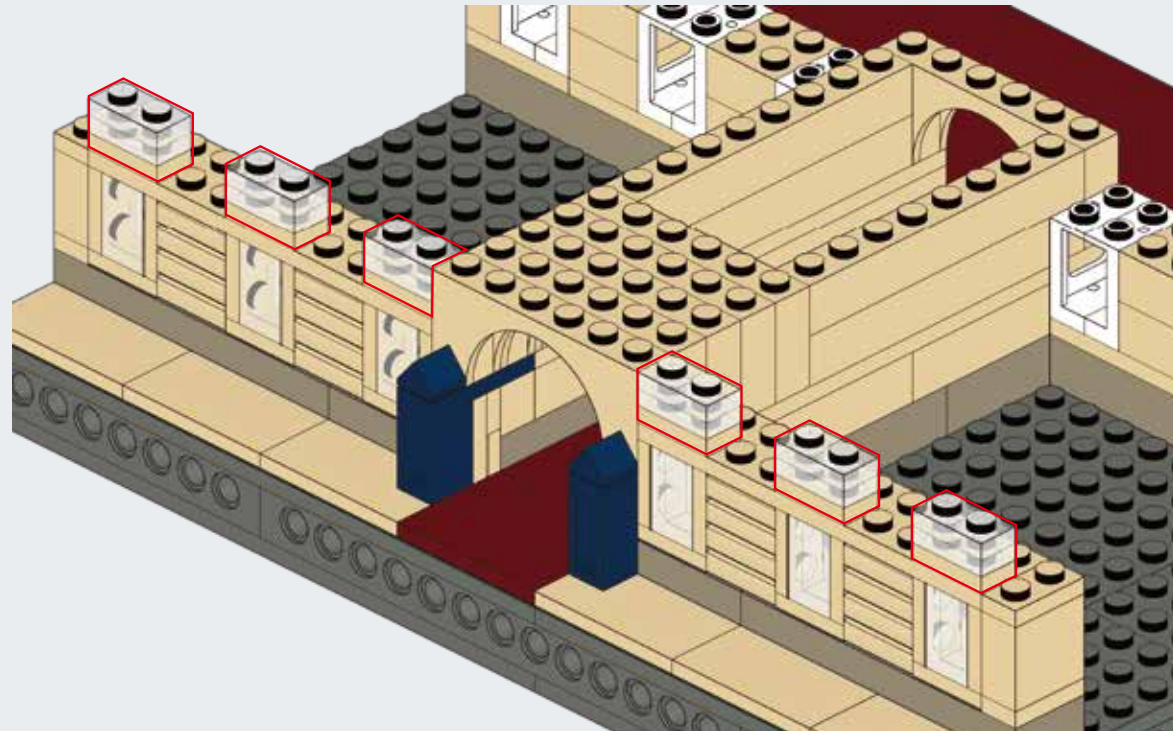
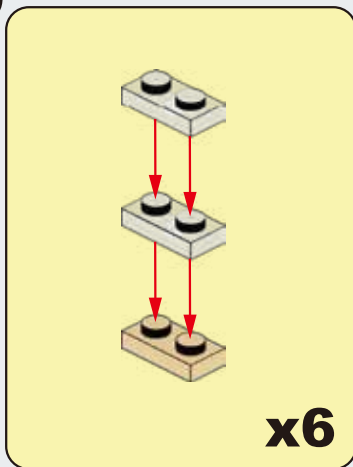

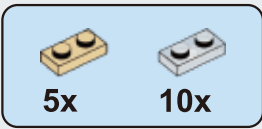

**D41**

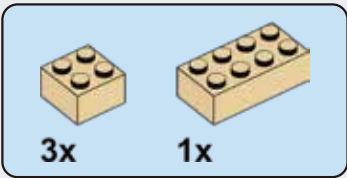
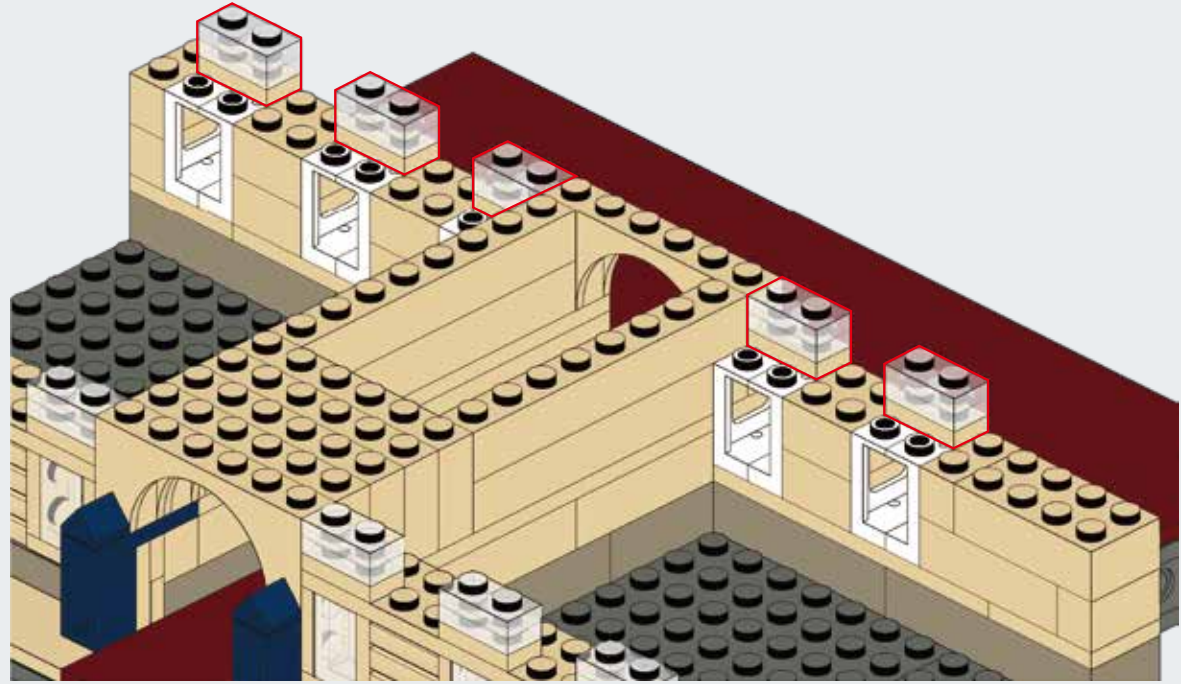
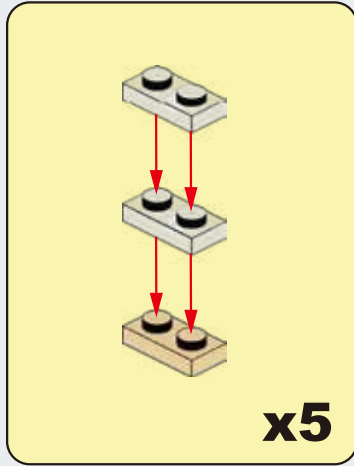

**D42**

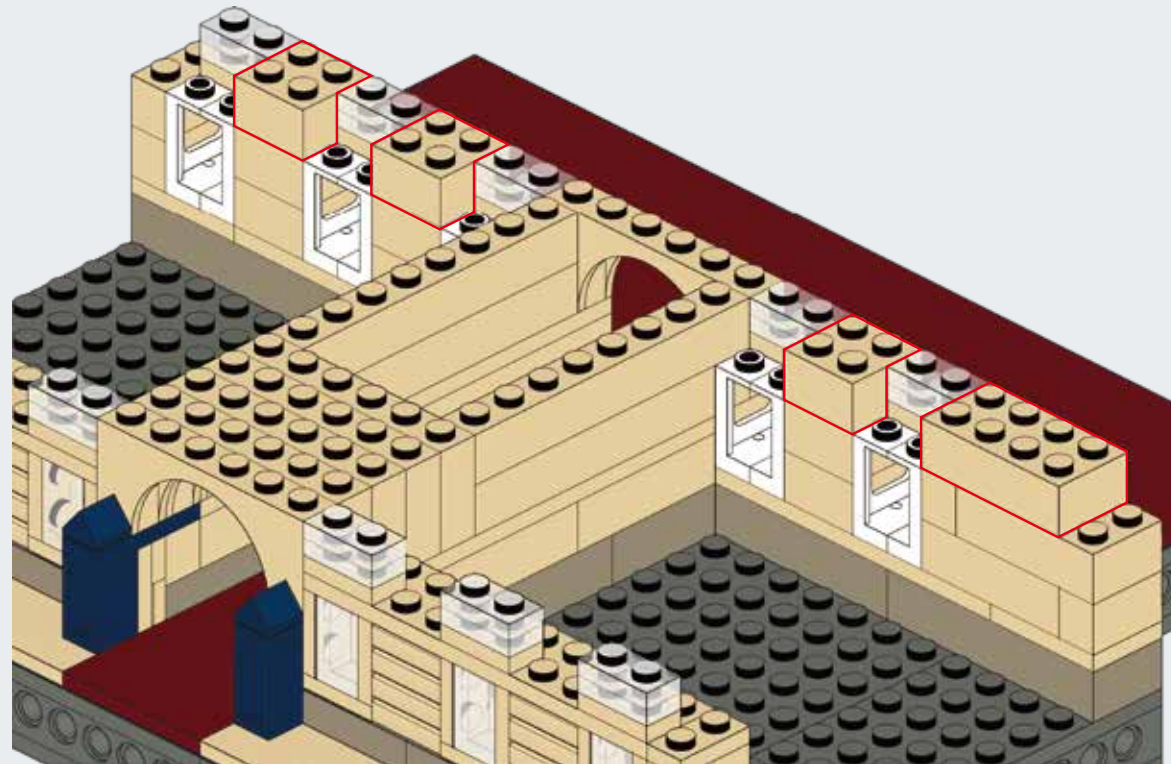

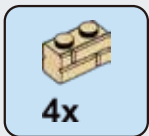

**D43**

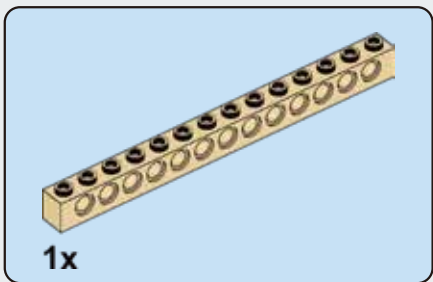
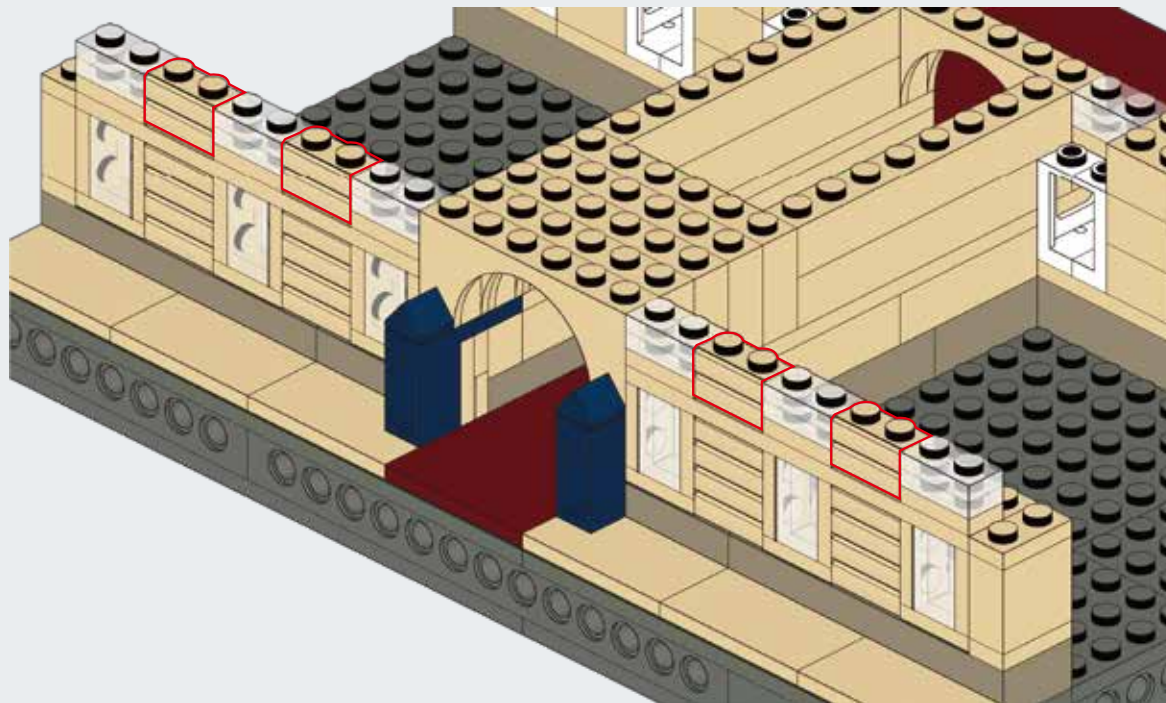

**D44**

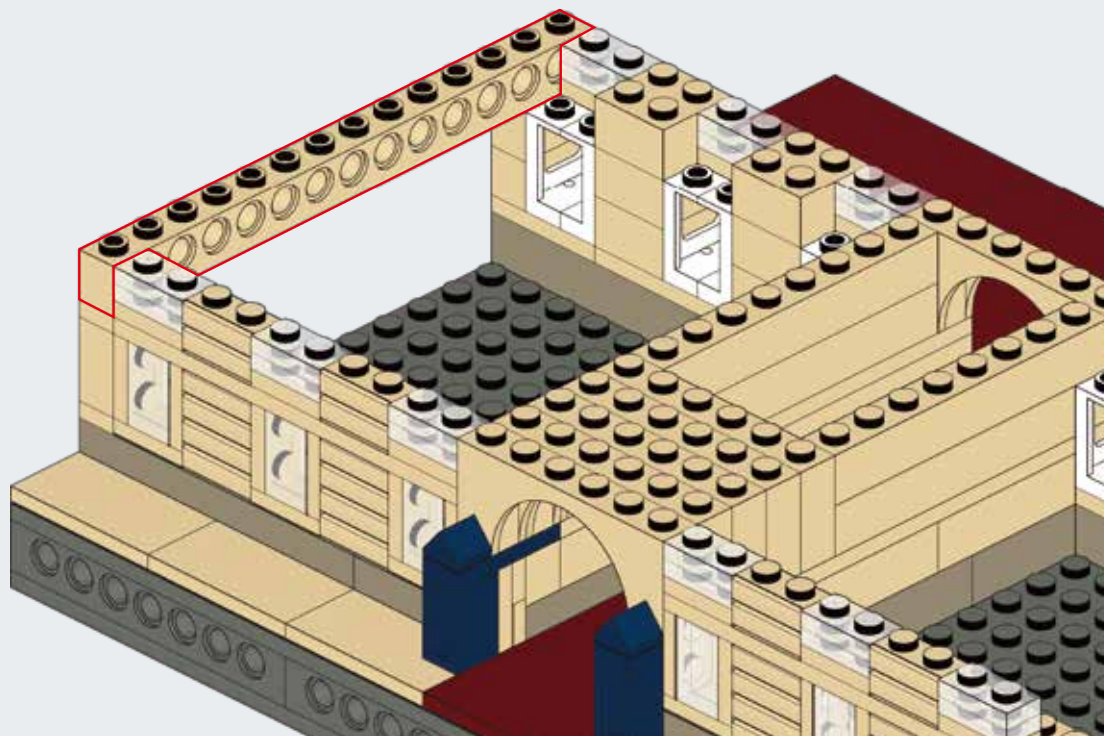

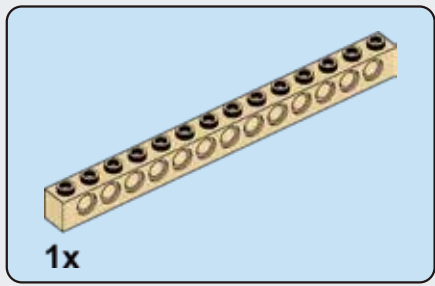

**D45**

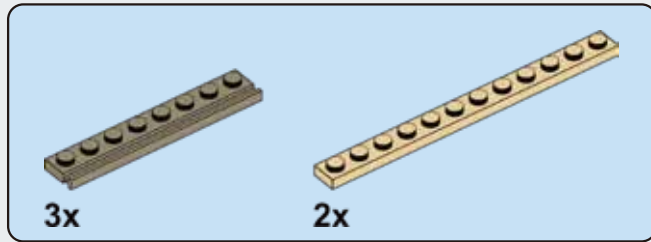
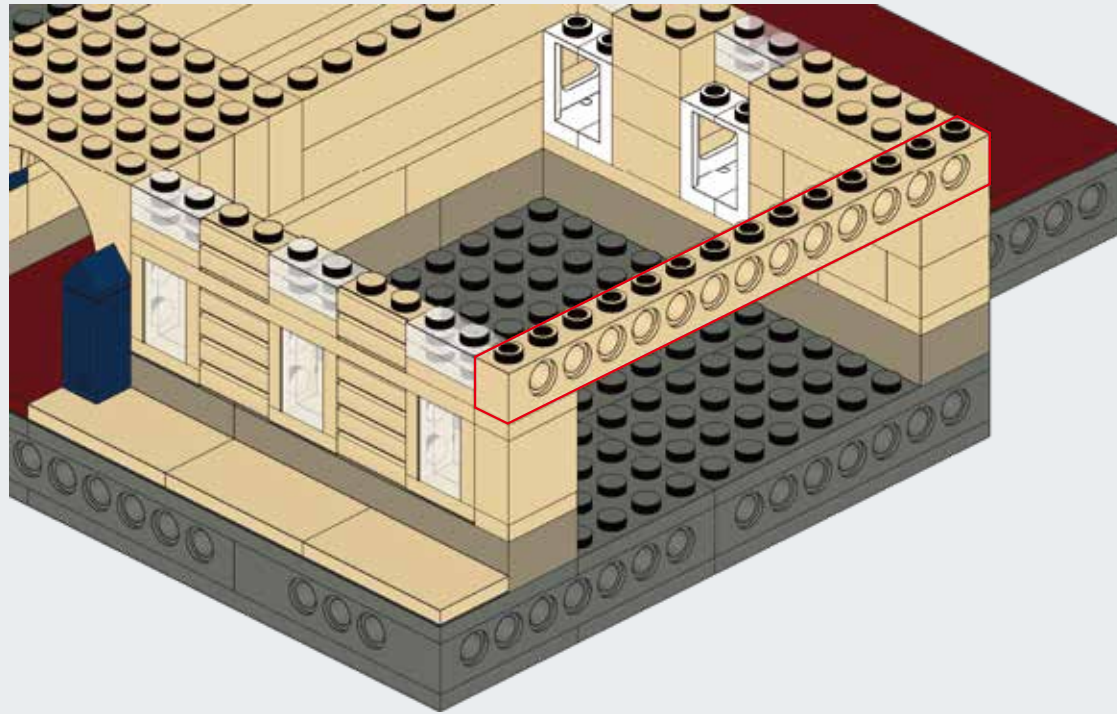

**D46**







**D47**

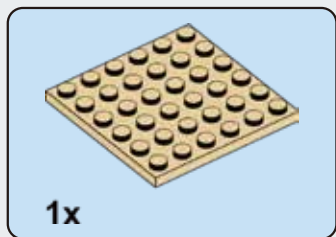

**D48**



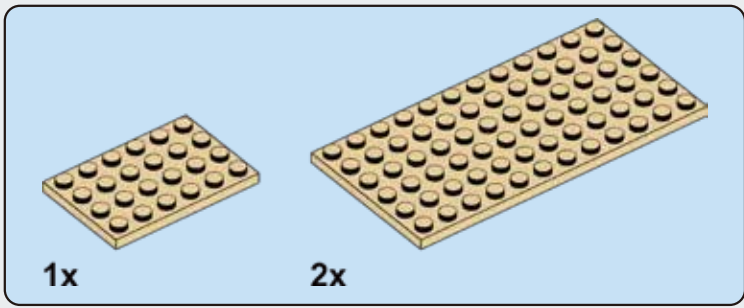

**D49**

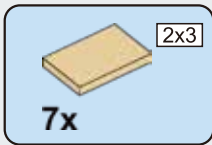
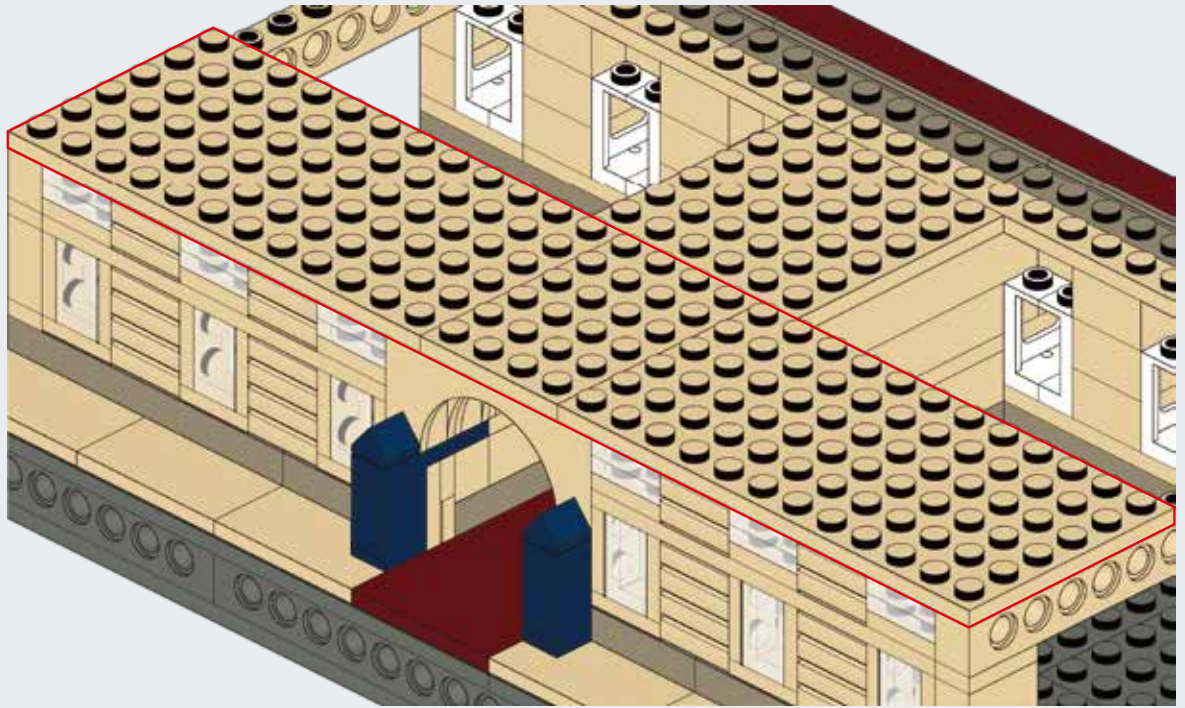

**D50**

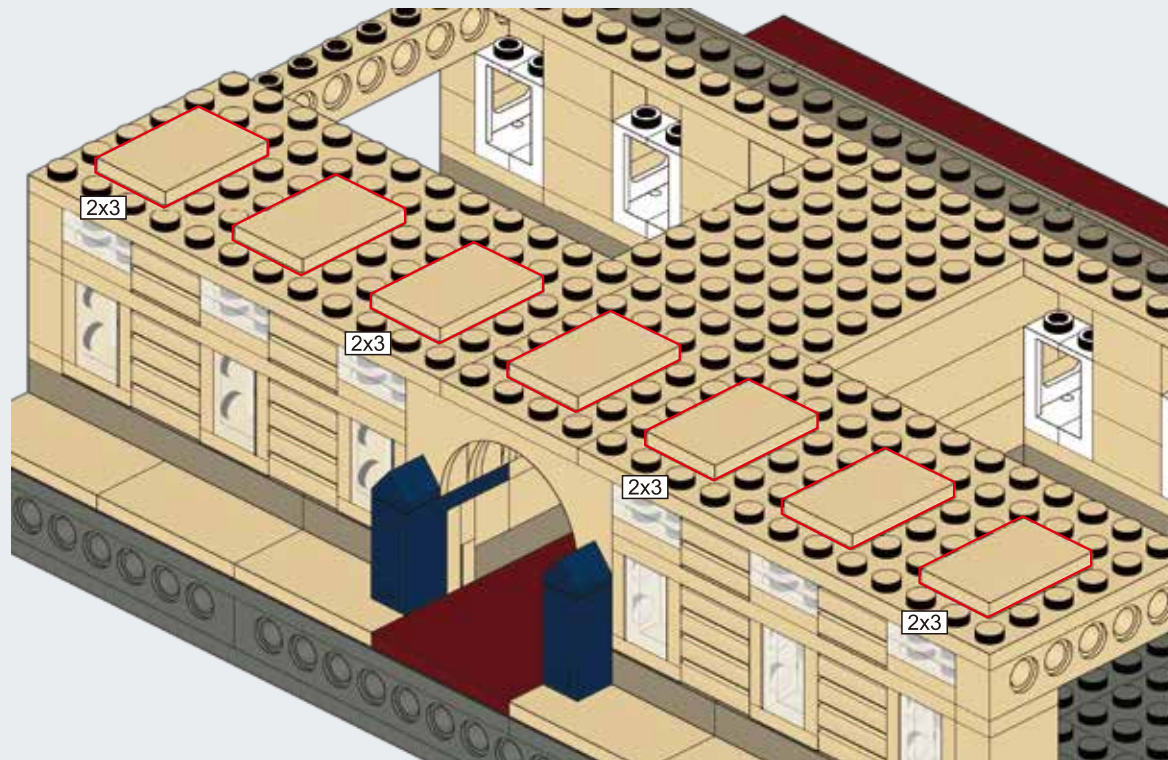



Buckingham Palace

滚滚长江东逝水



4

Please download the building instruction from below website.

[en.doubleeagle-group.com](http://en.doubleeagle-group.com)

403ARC615010004

C61501

5604PCS

Designer: Tobias Thieme