

A138

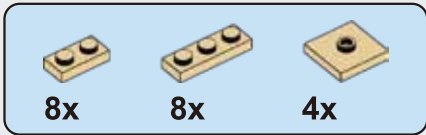

A139

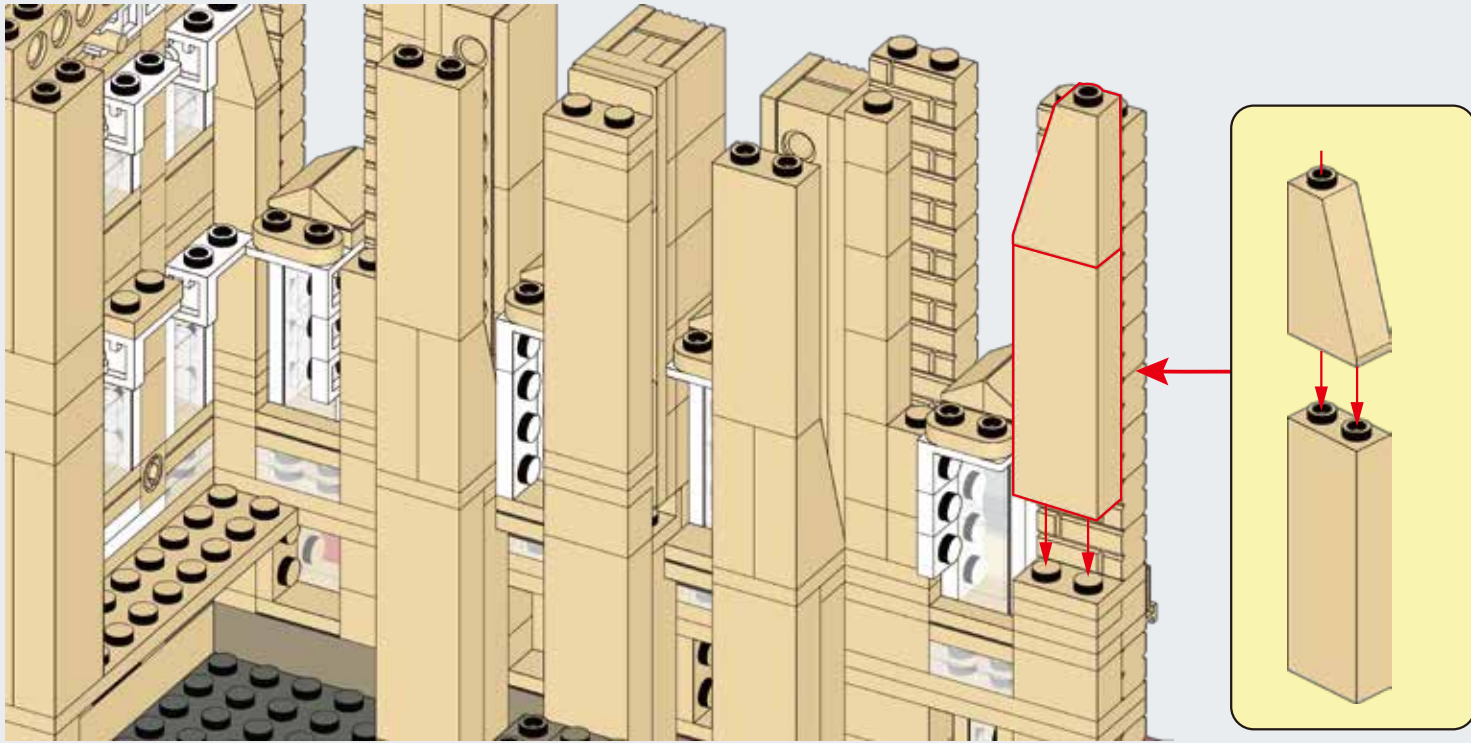
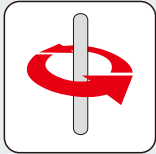
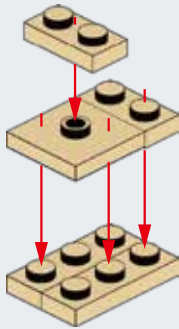

x4



A140

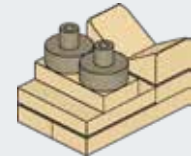
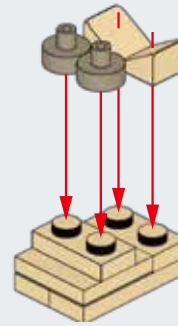

x4

A141

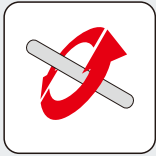

A138

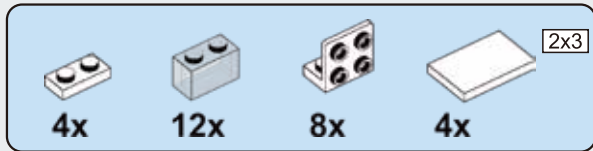
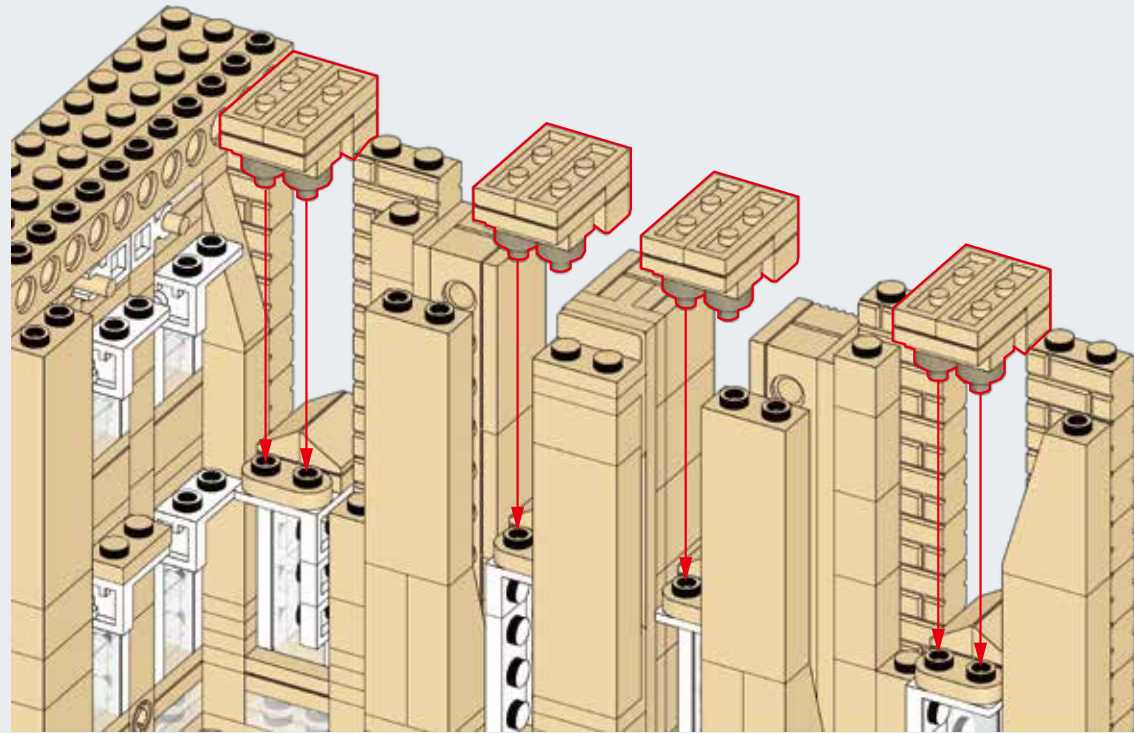

A142

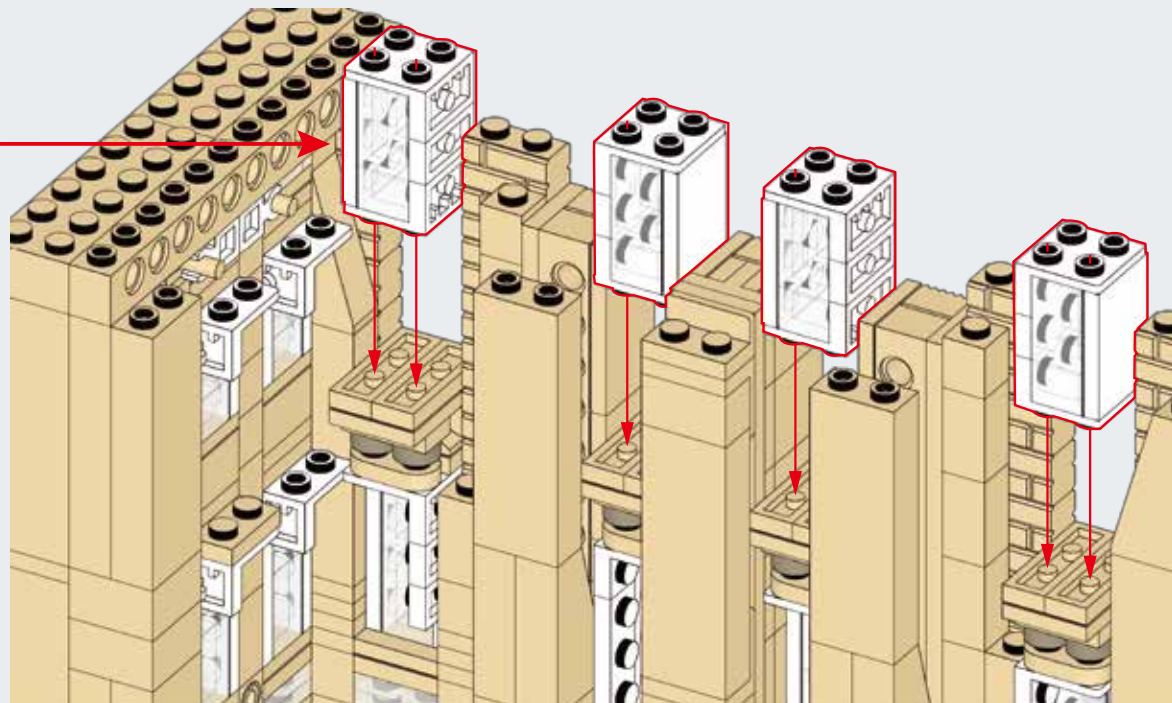
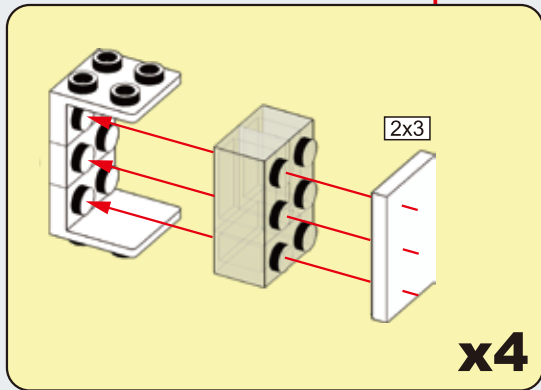

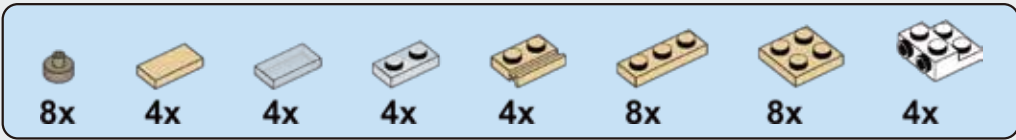

A143

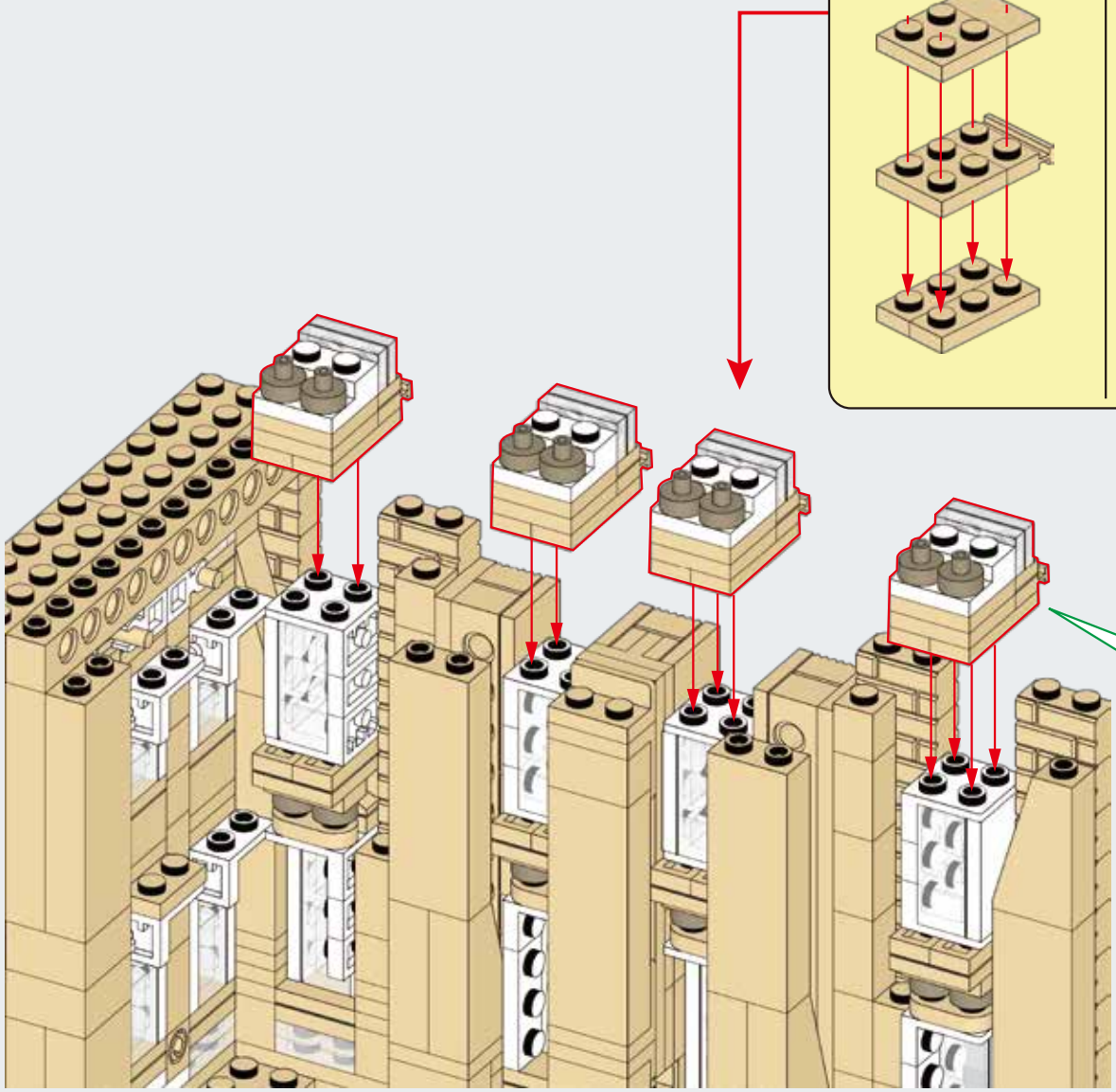
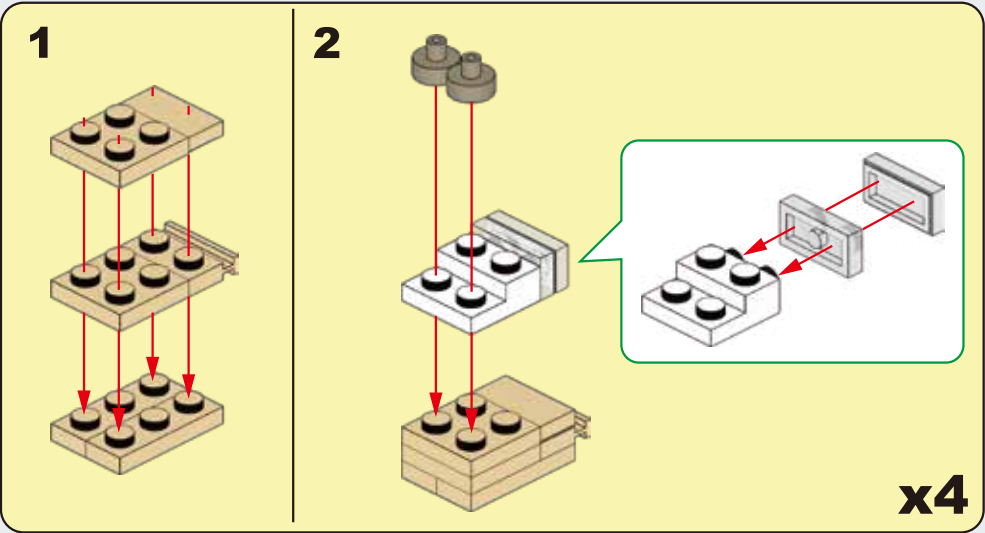

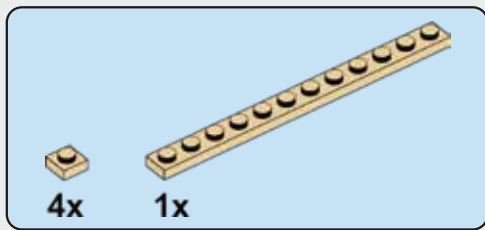

A144

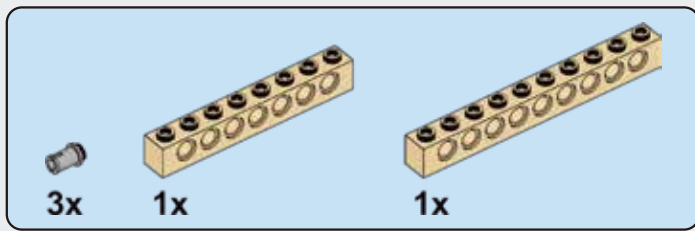
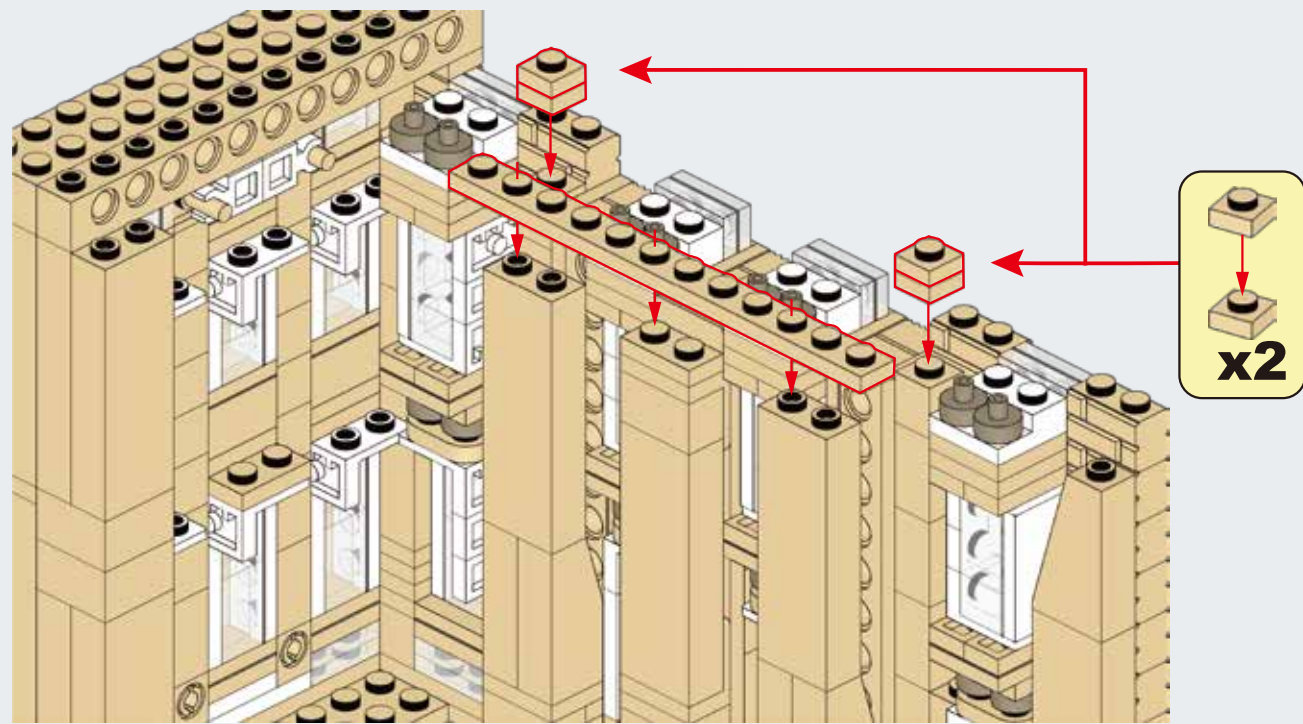

A145

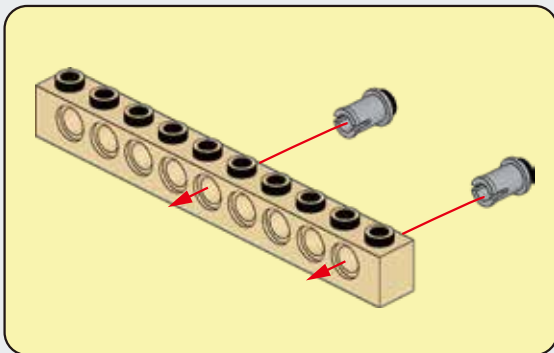
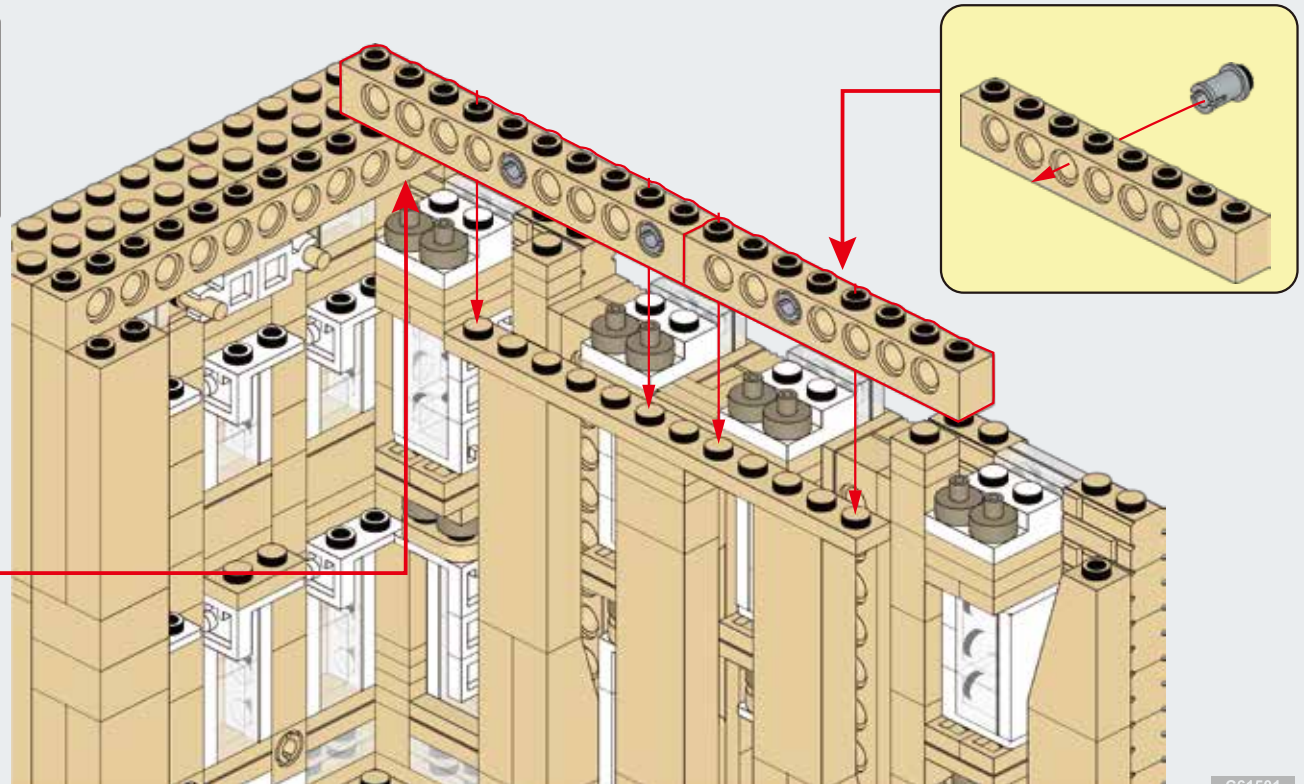



A146

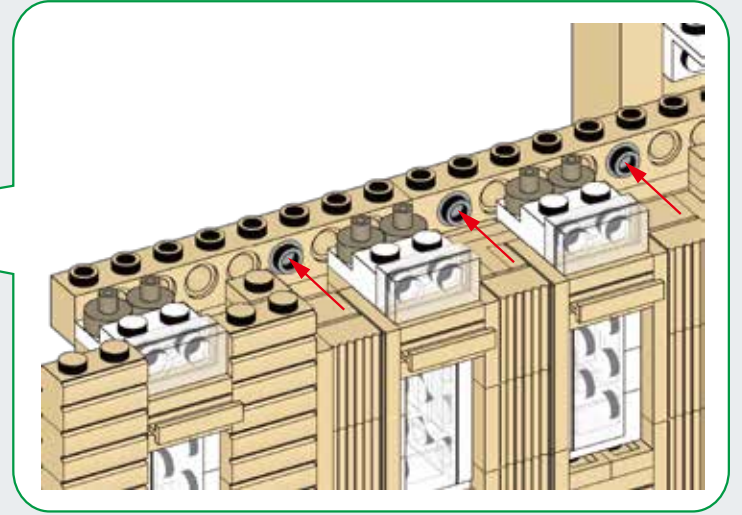
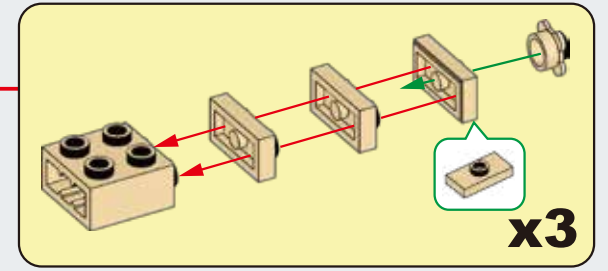
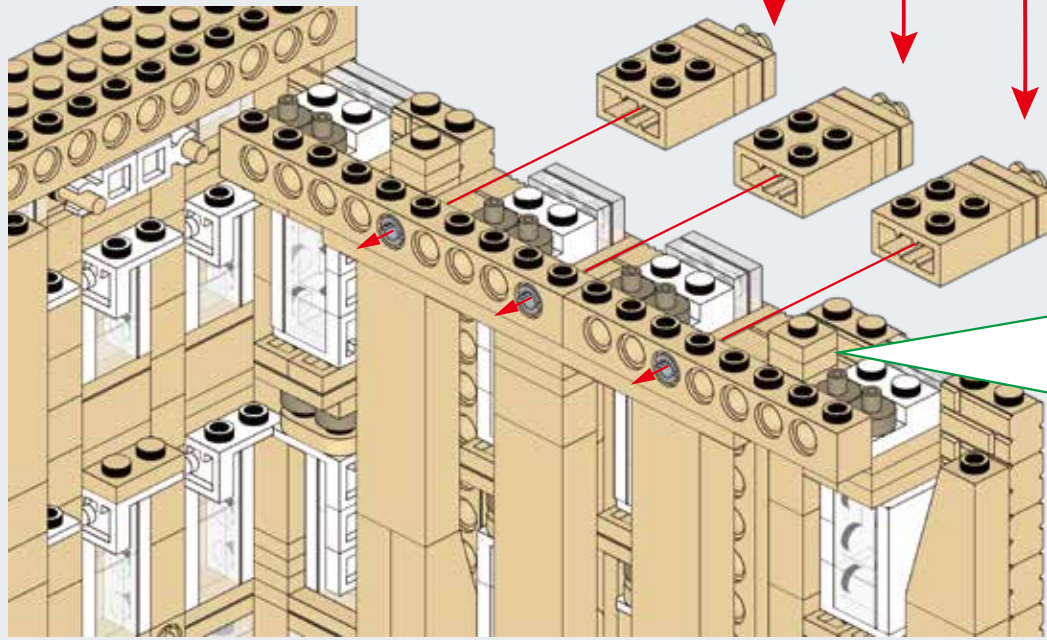

A147

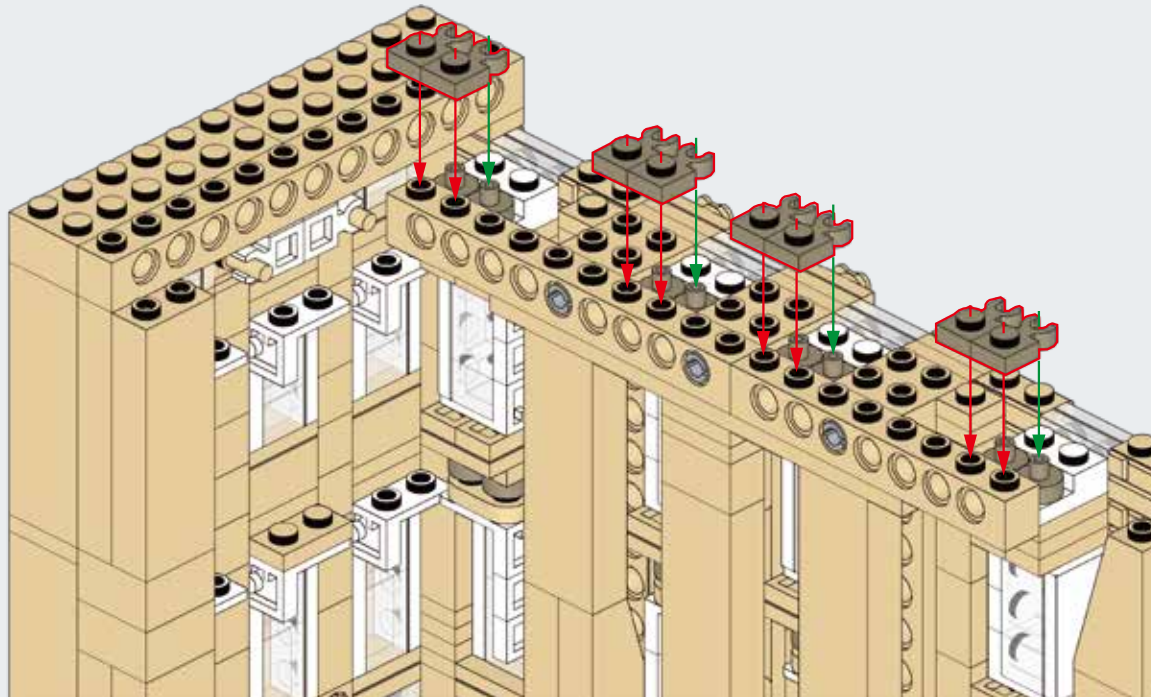



A148

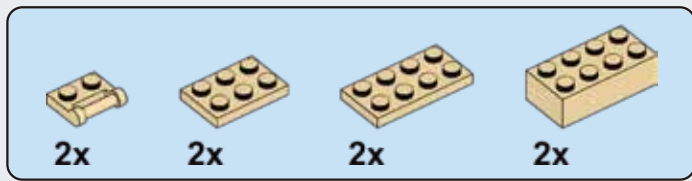
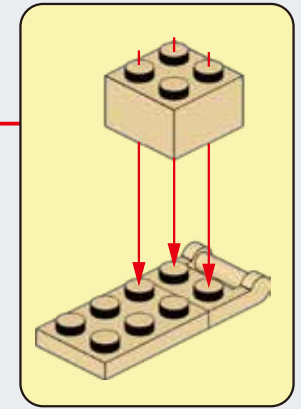
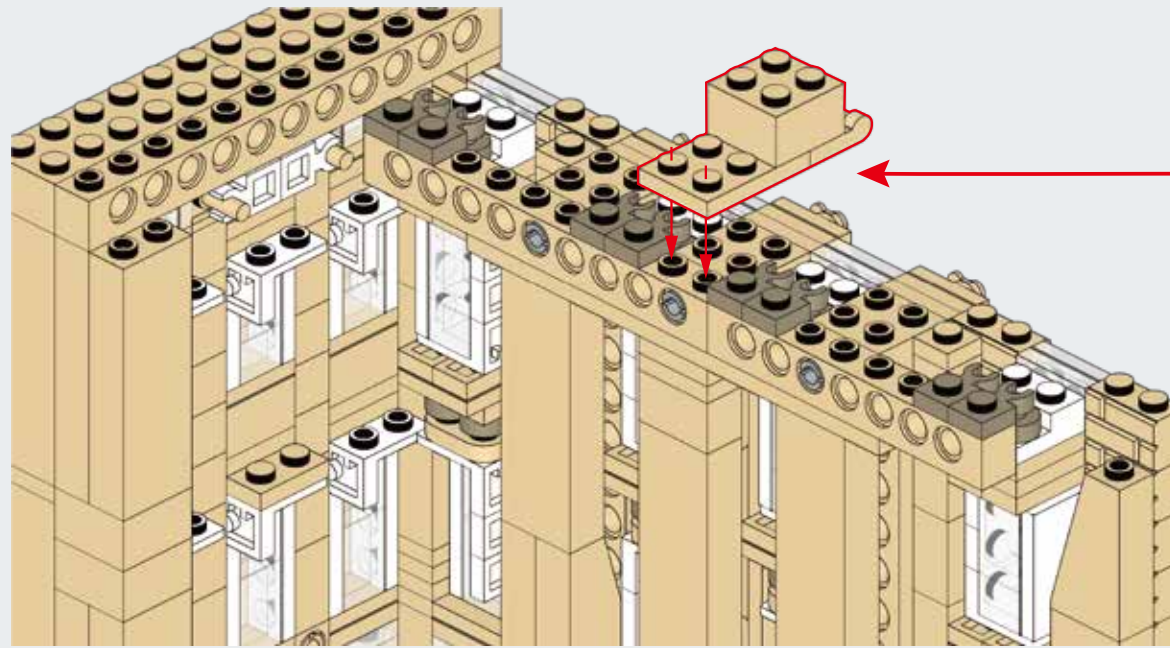

A149

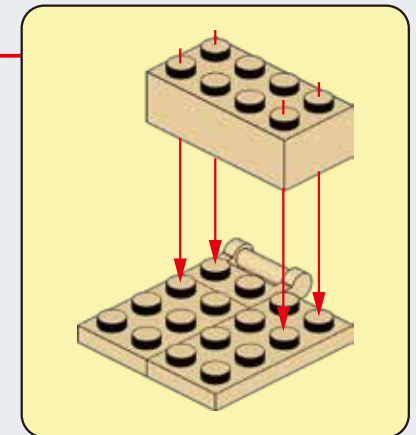
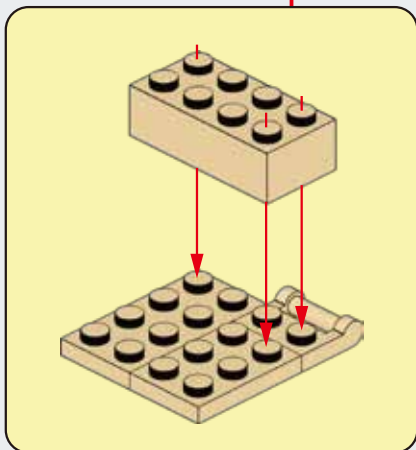
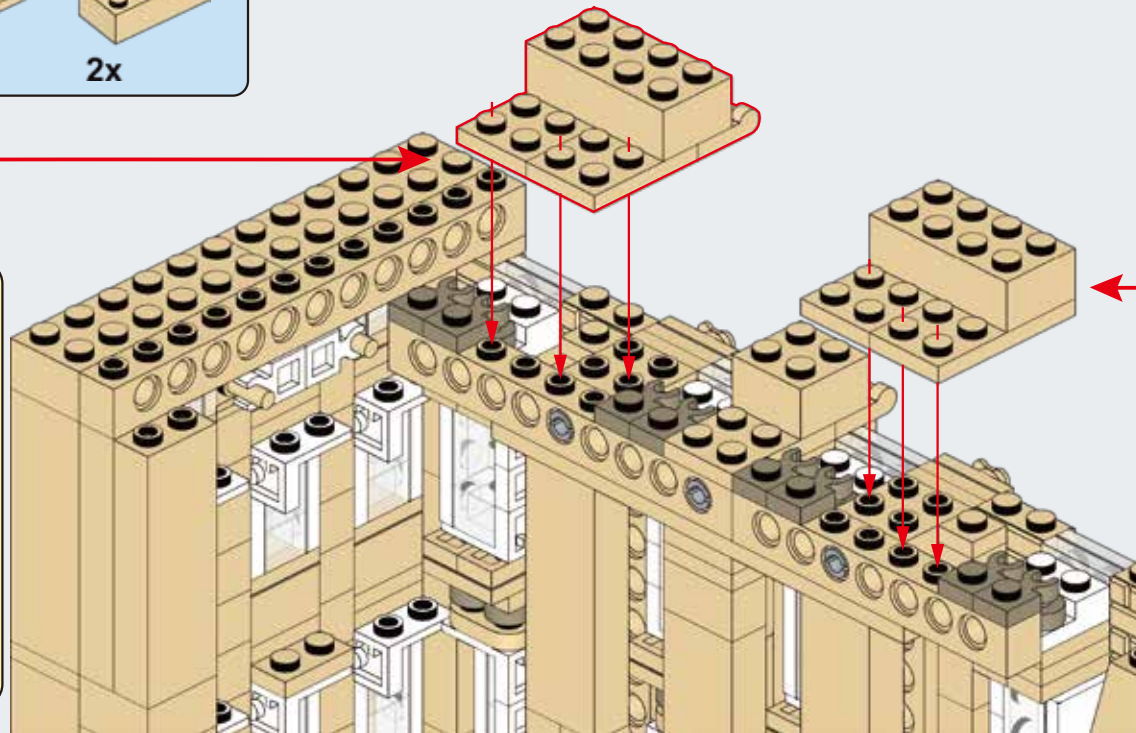

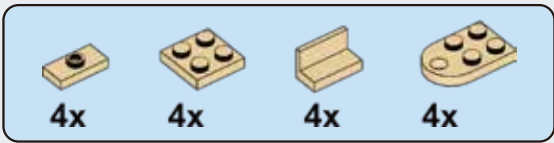

A150

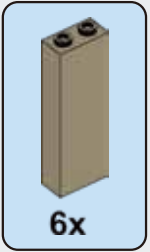
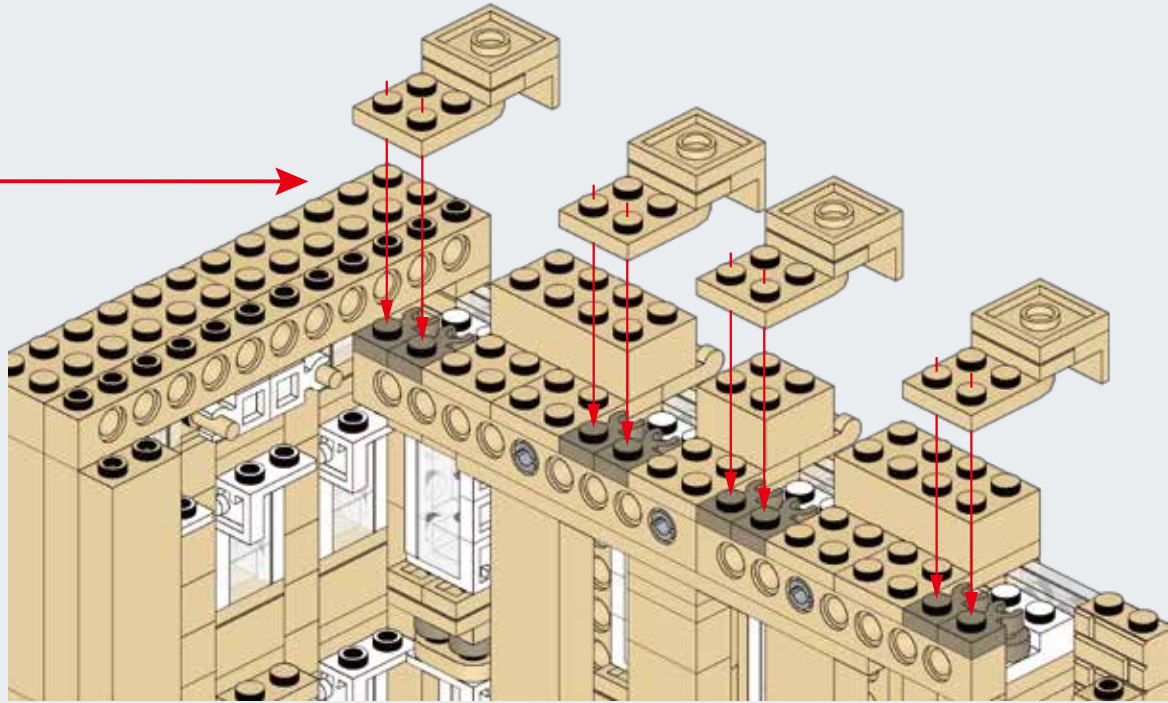
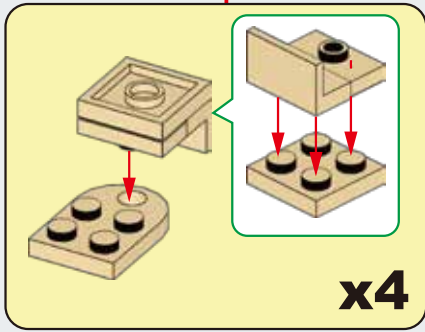

A151

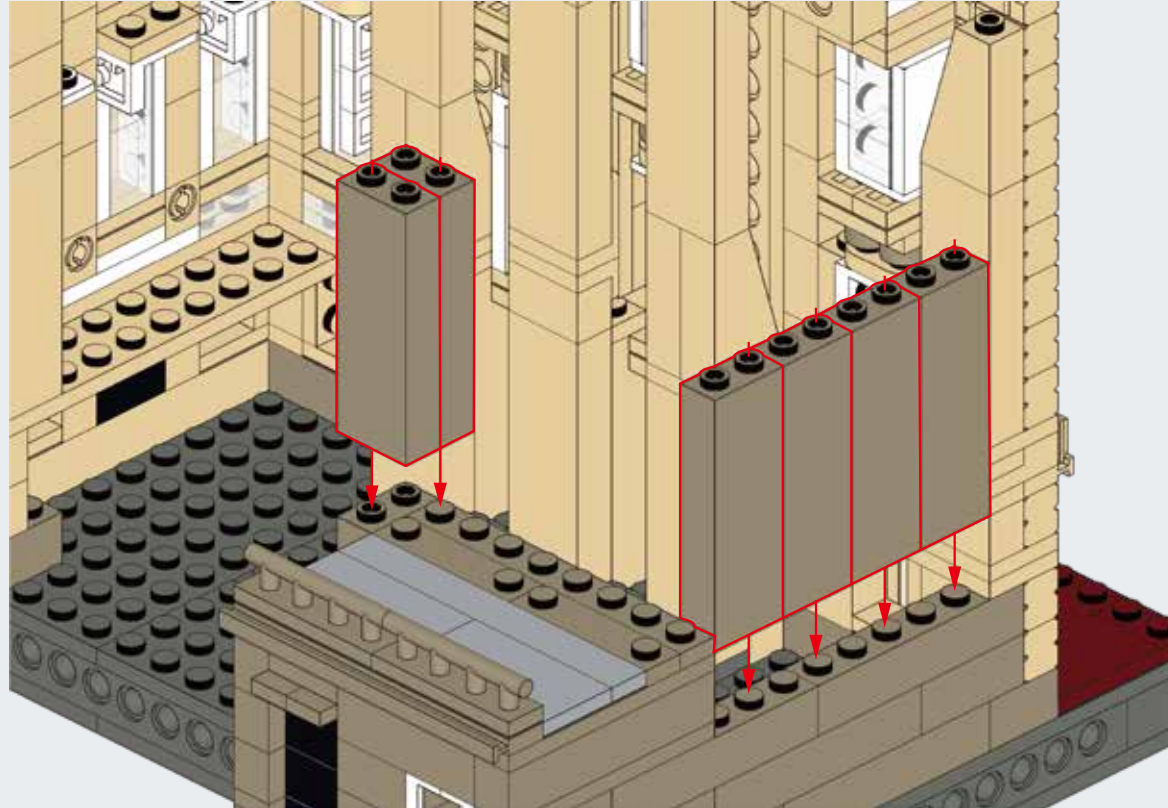

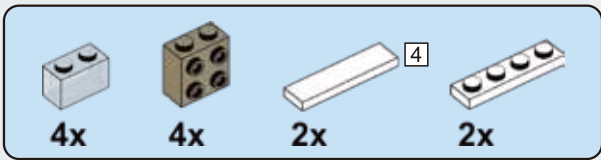

A152

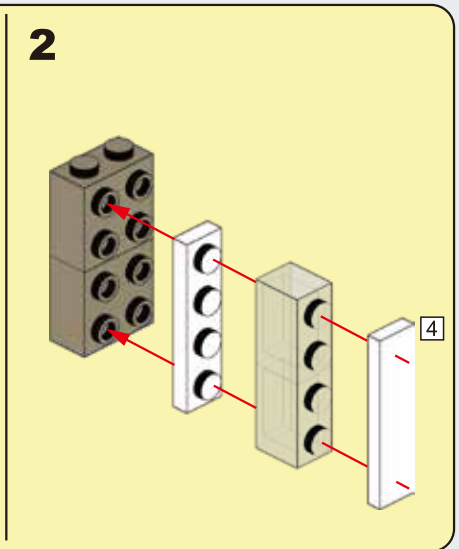
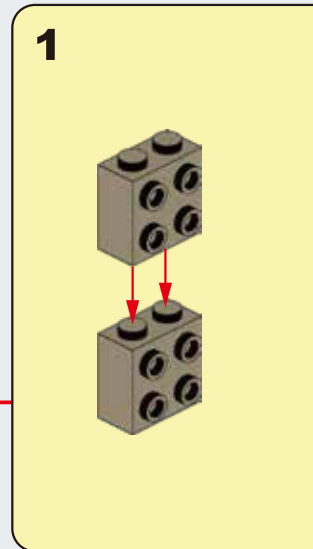
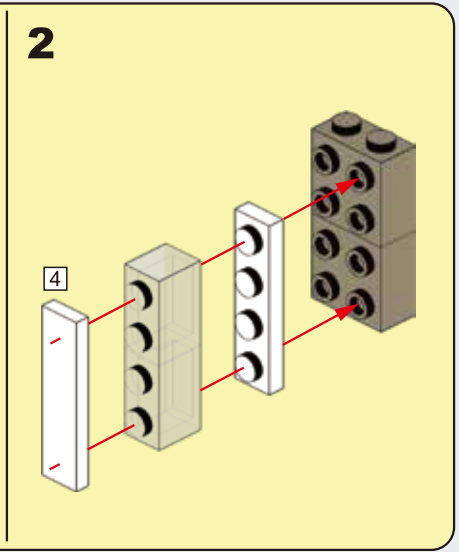
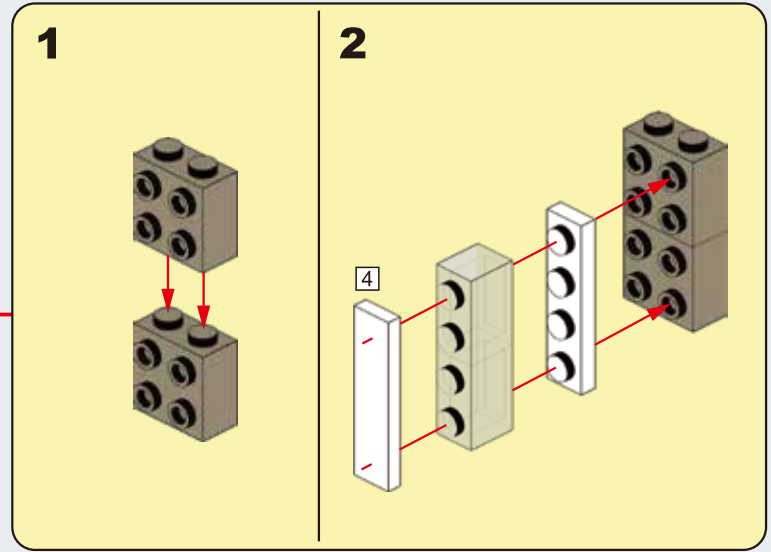
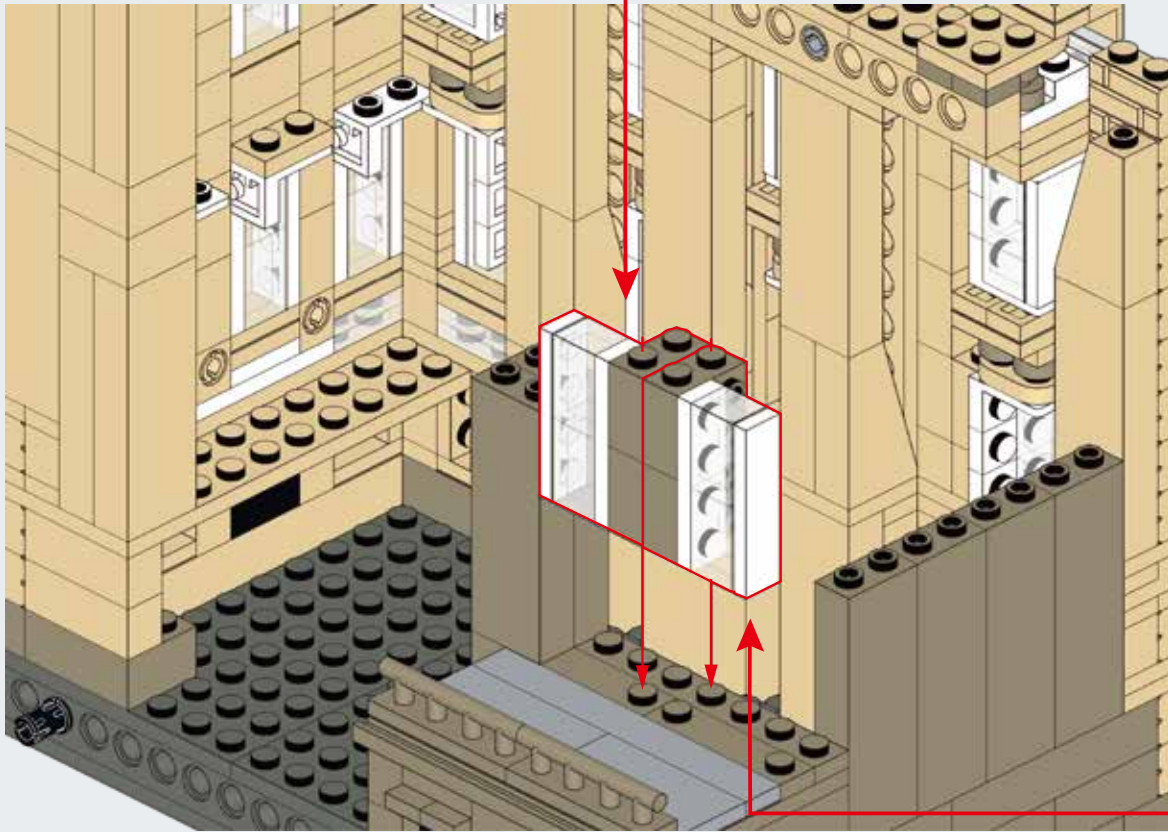

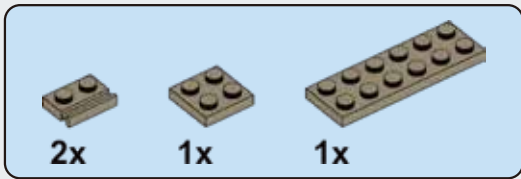

A153

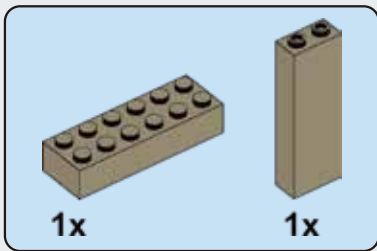
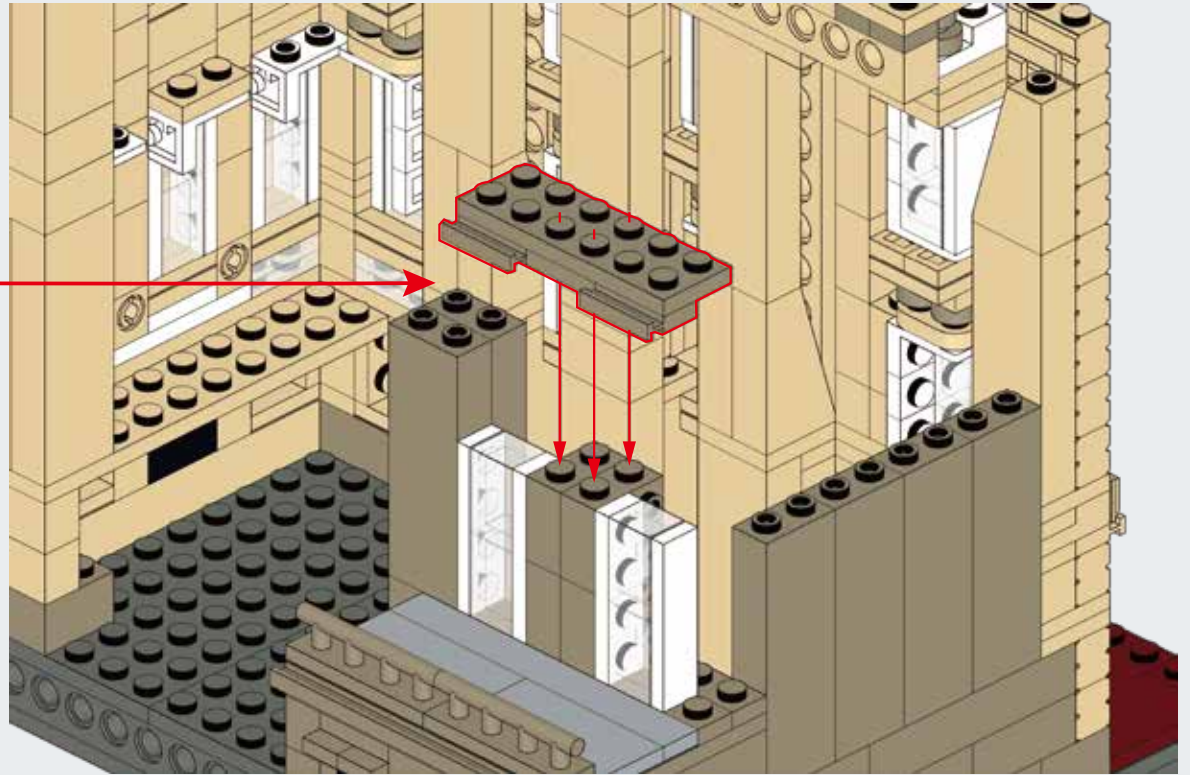
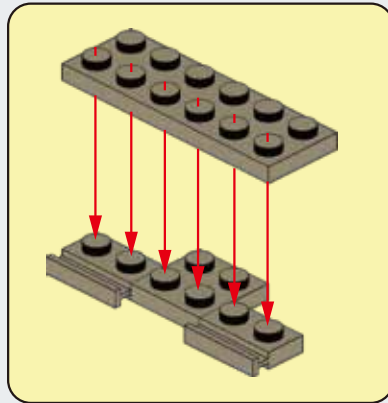

A154

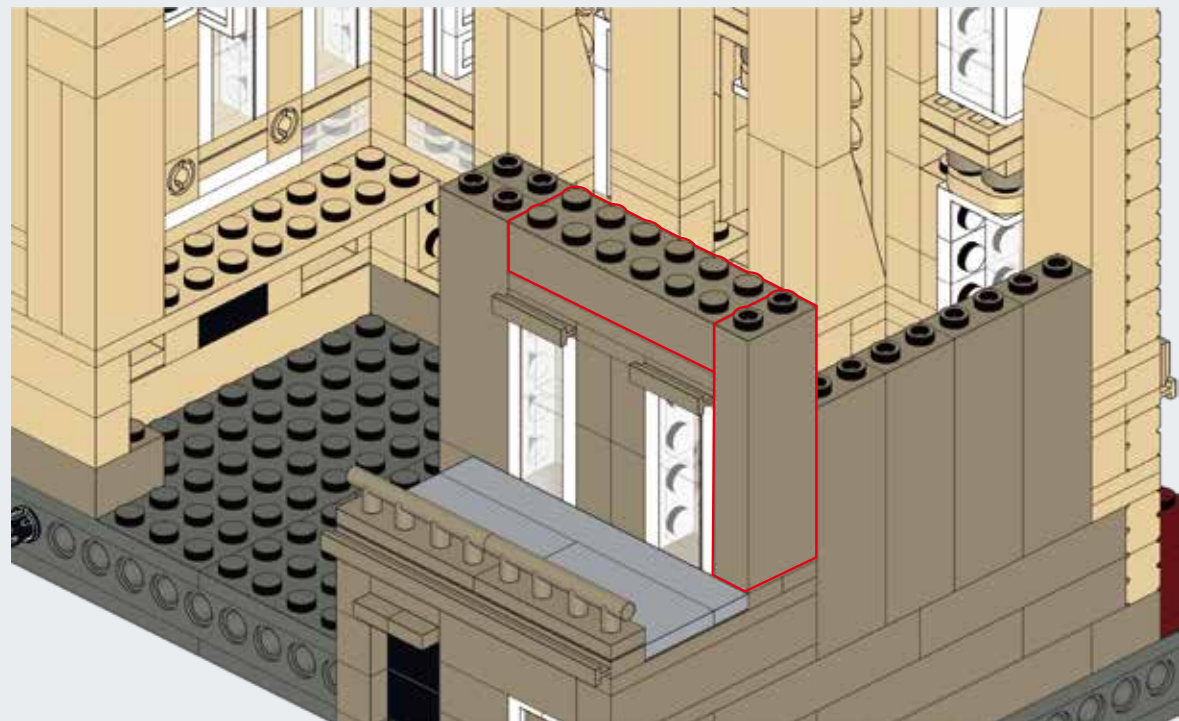

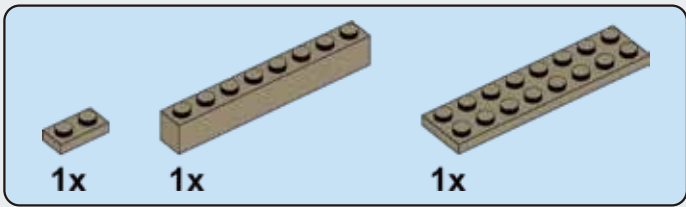

A155

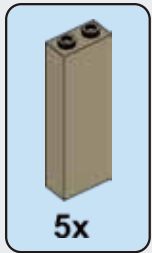
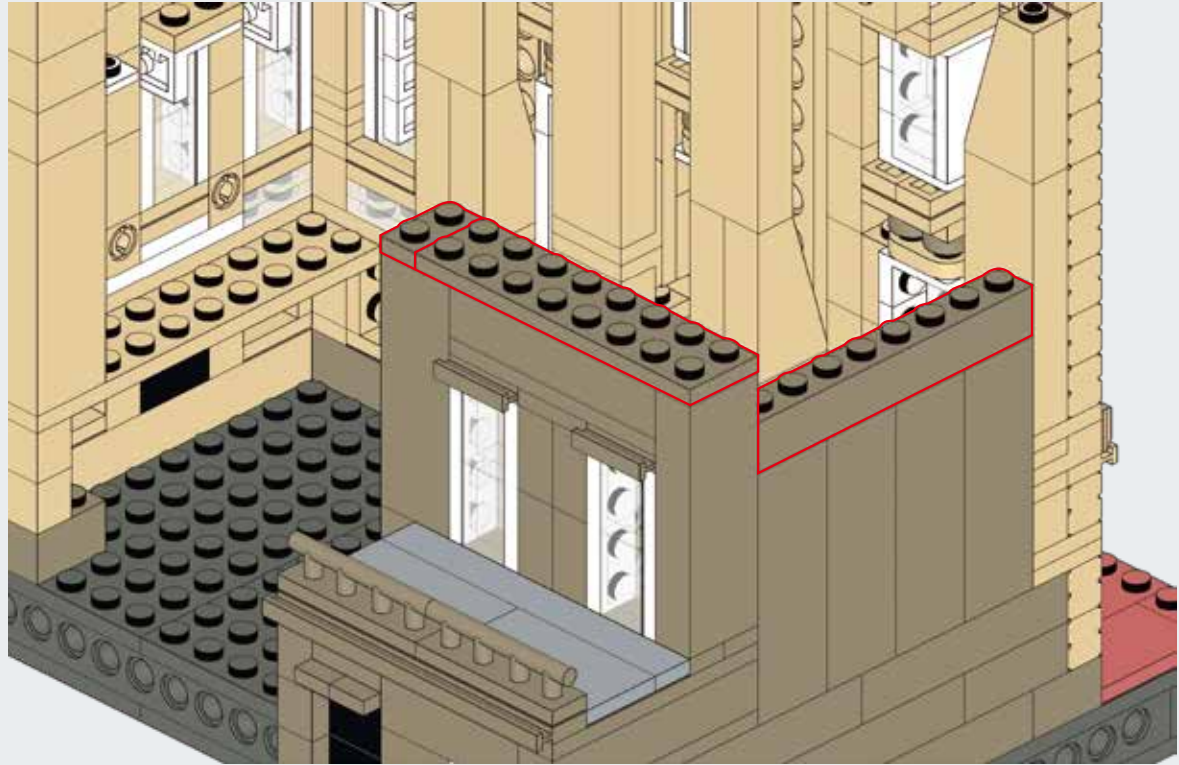

A156

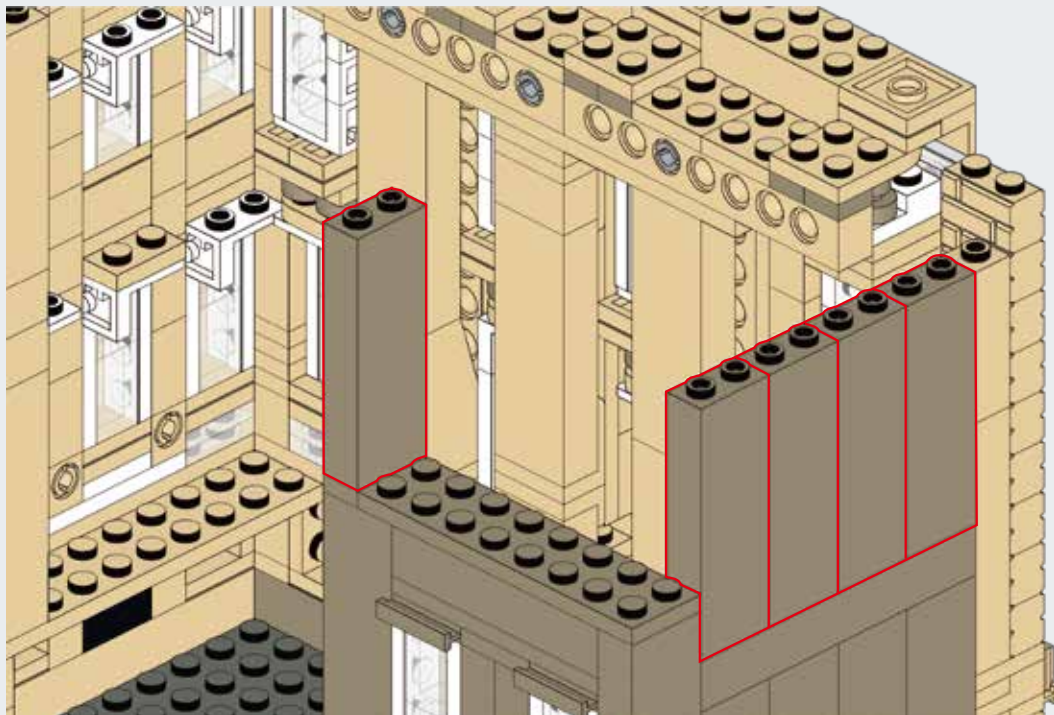

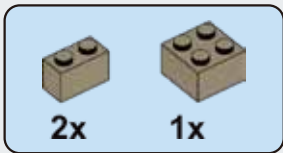

A157

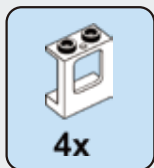
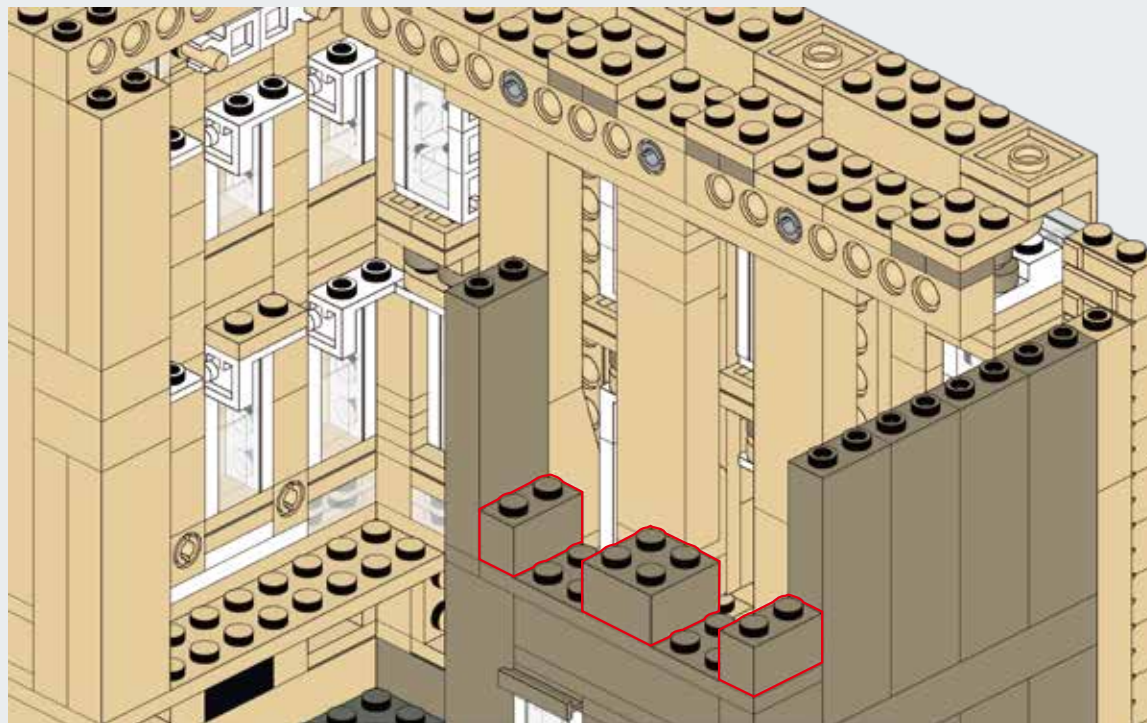

A158

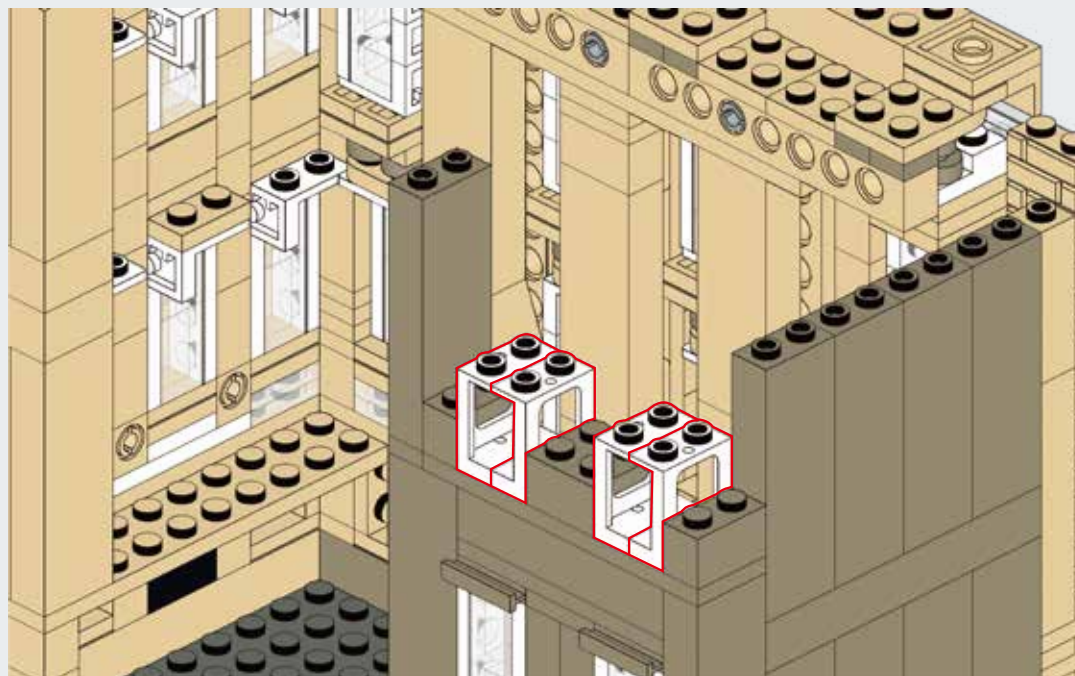

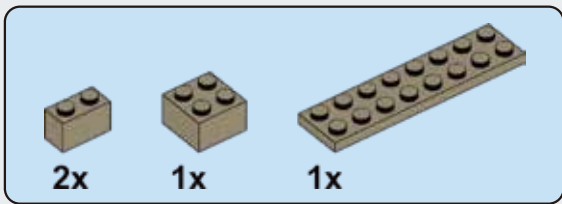

A159

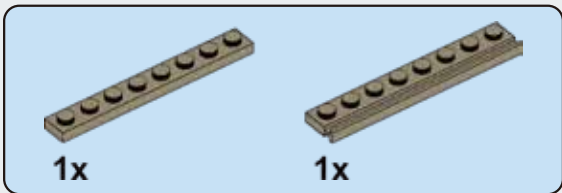
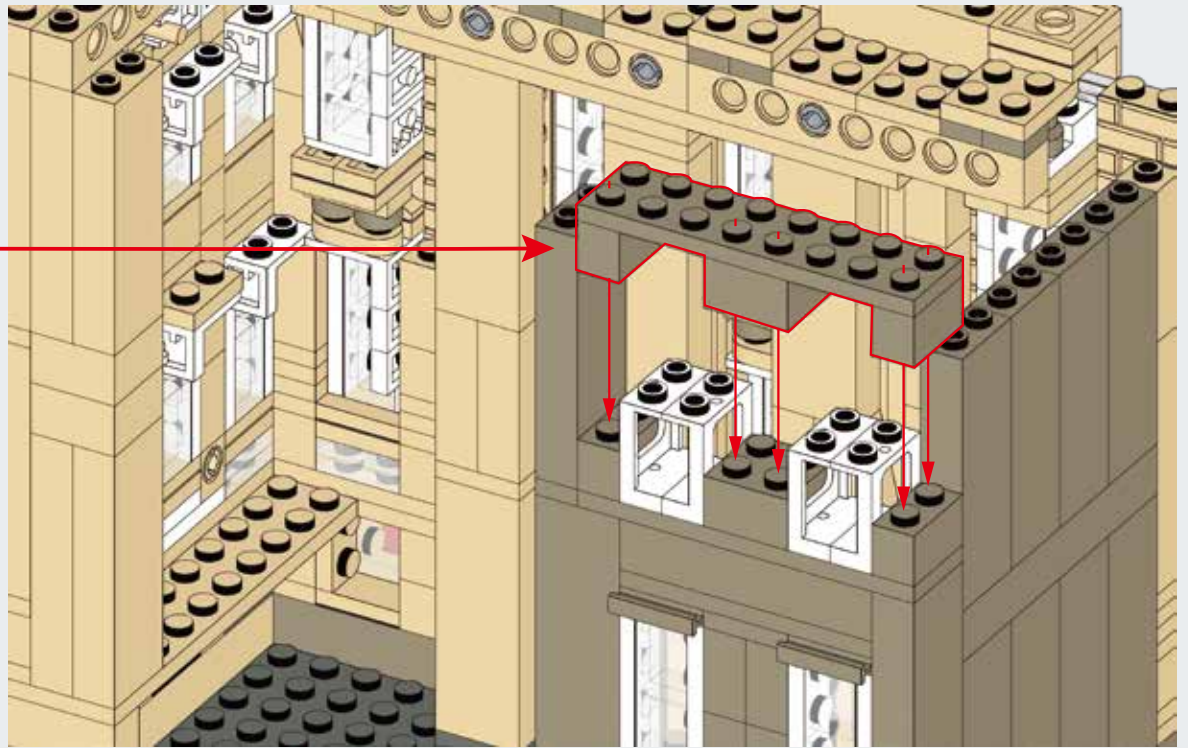
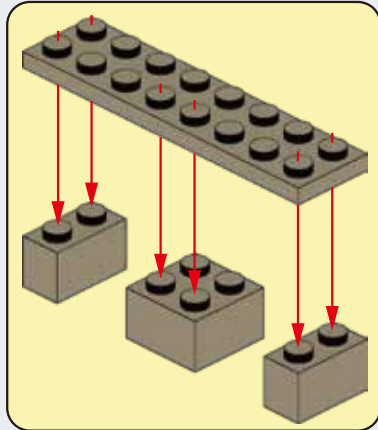

A160

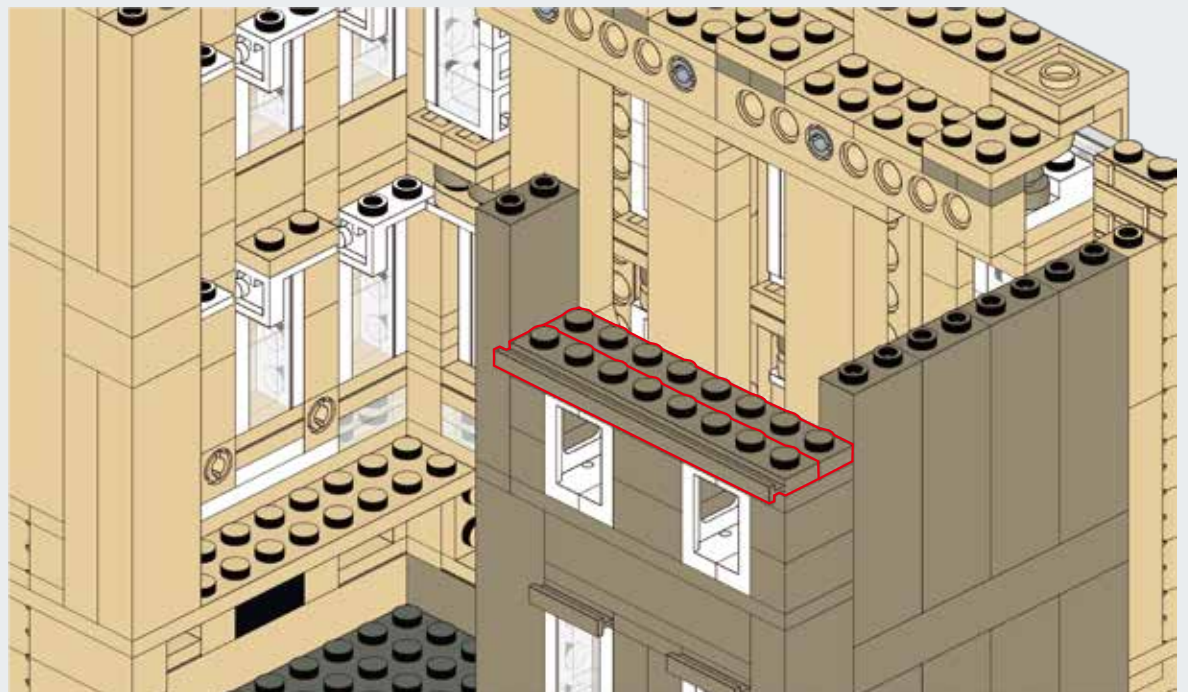

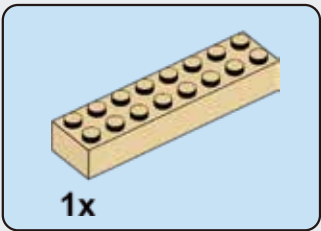

A161

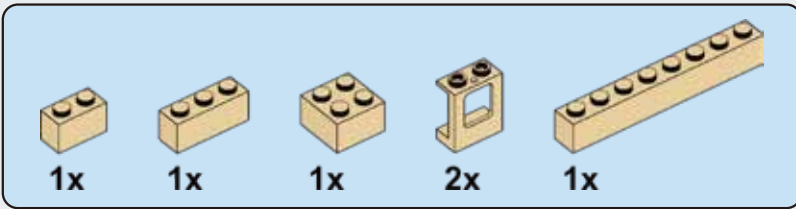
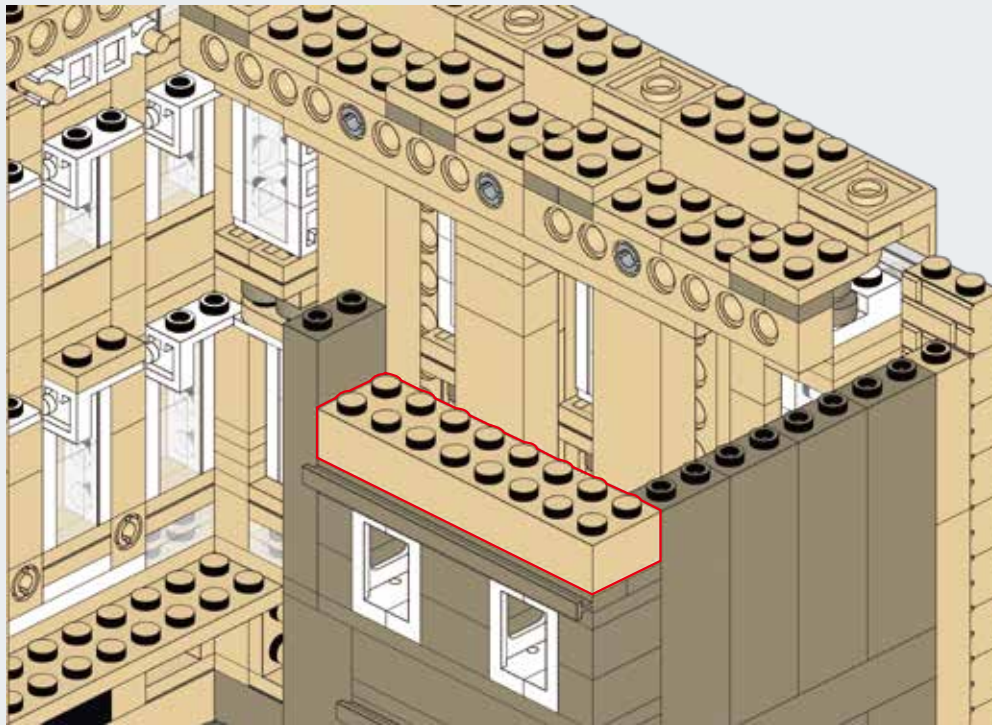

A162

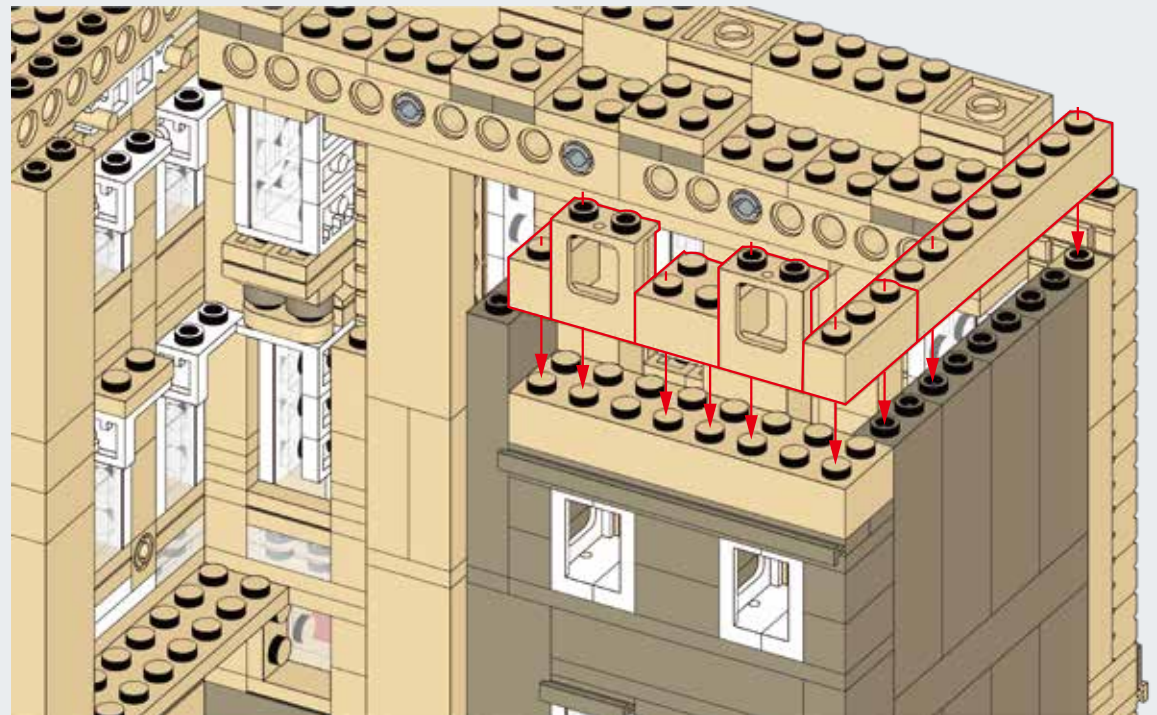

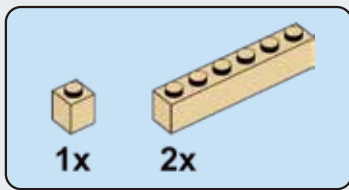

A163

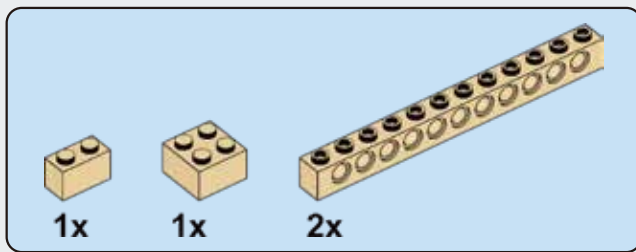
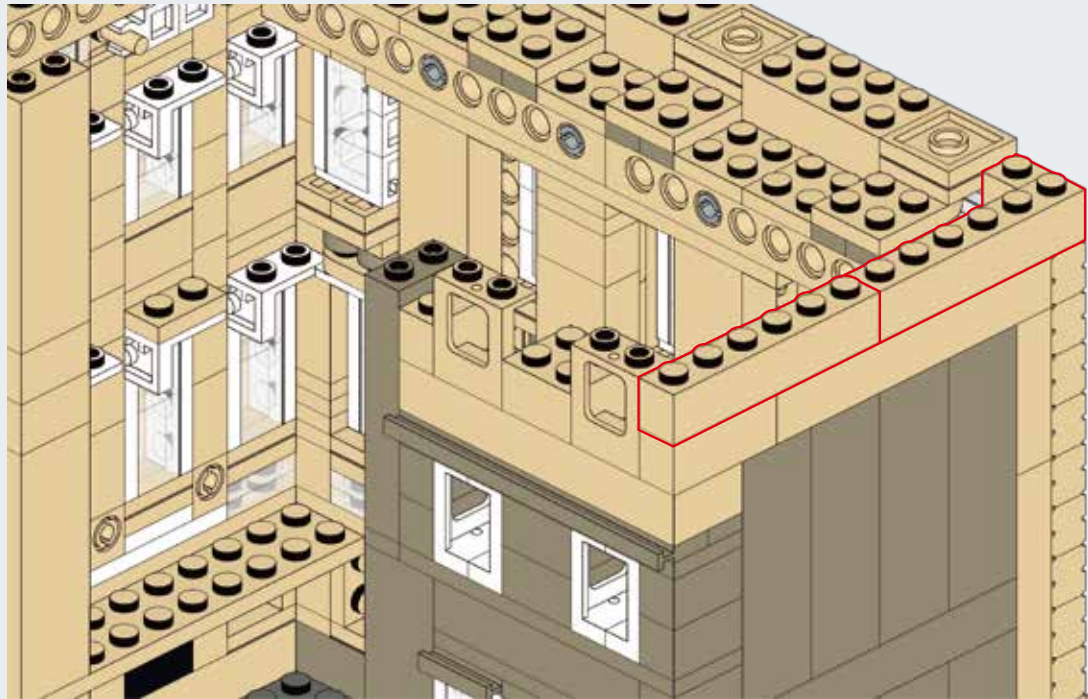

A164

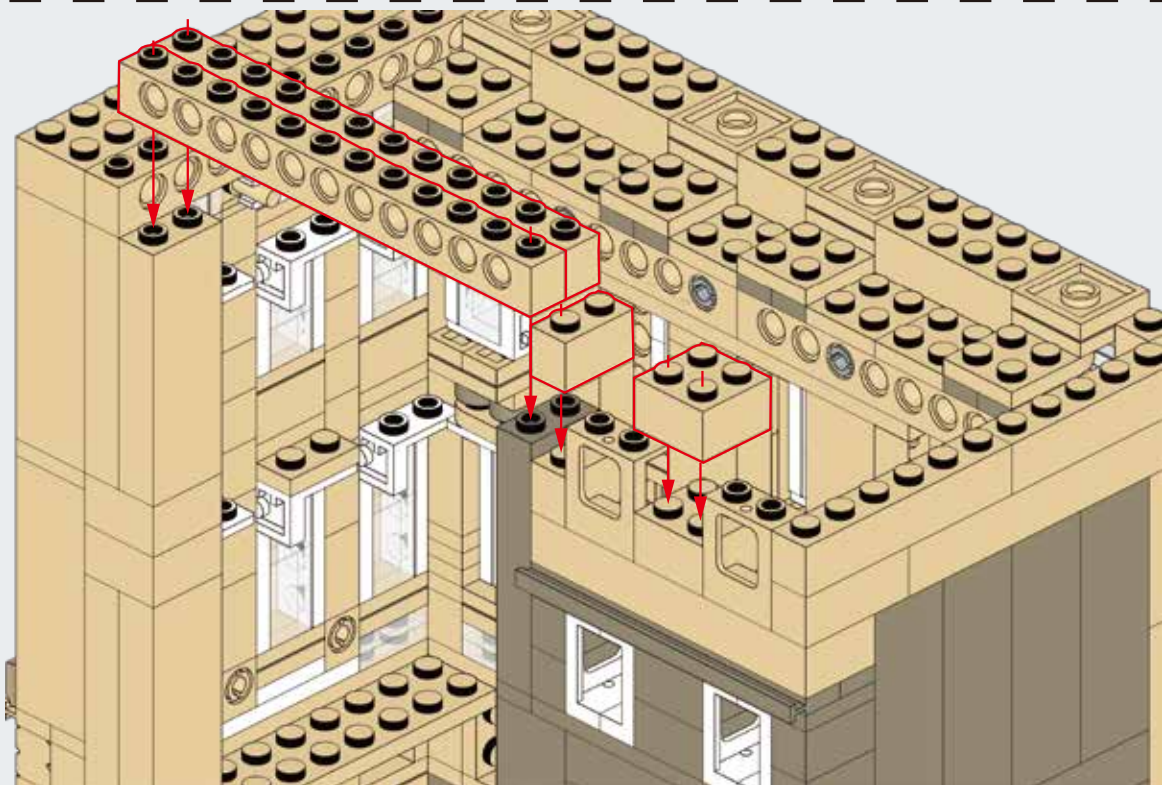

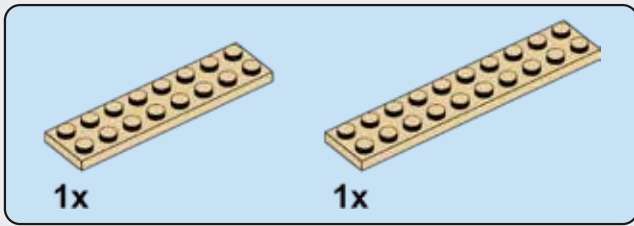

A165

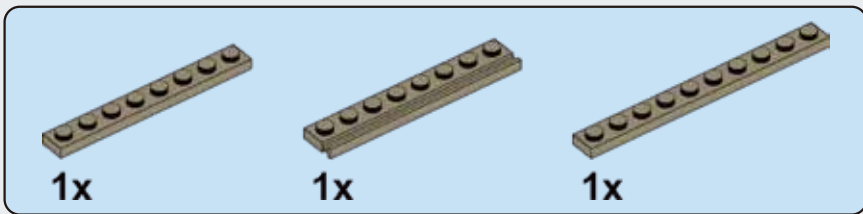
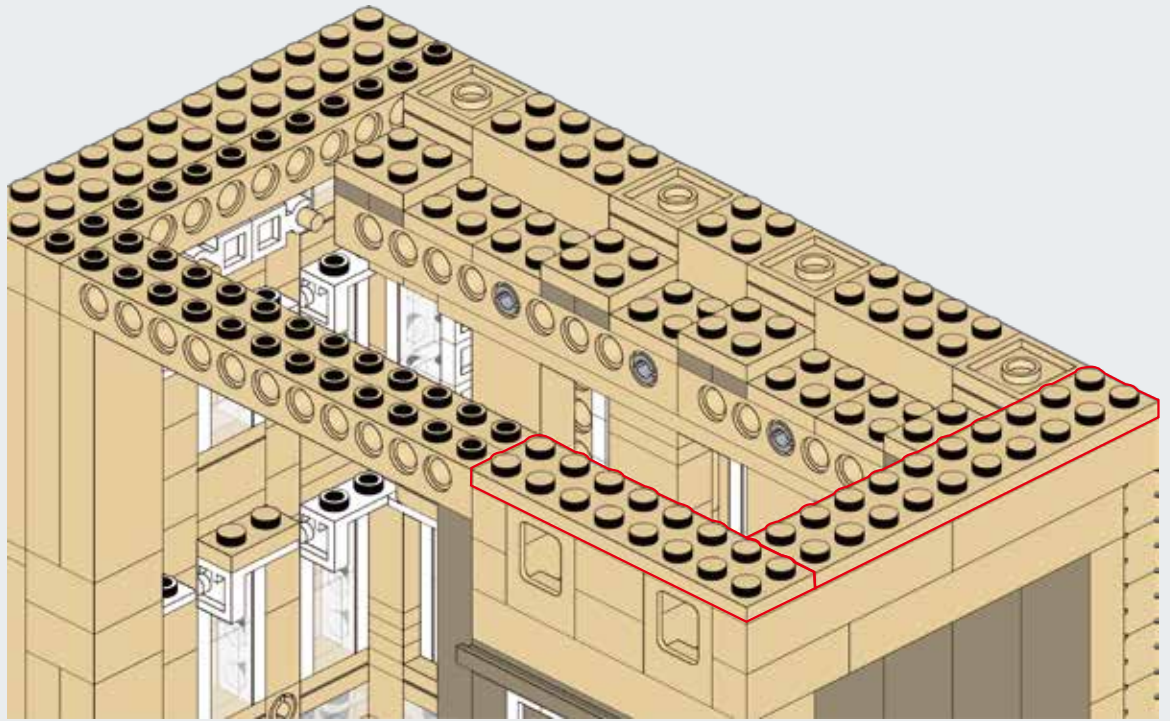

A166

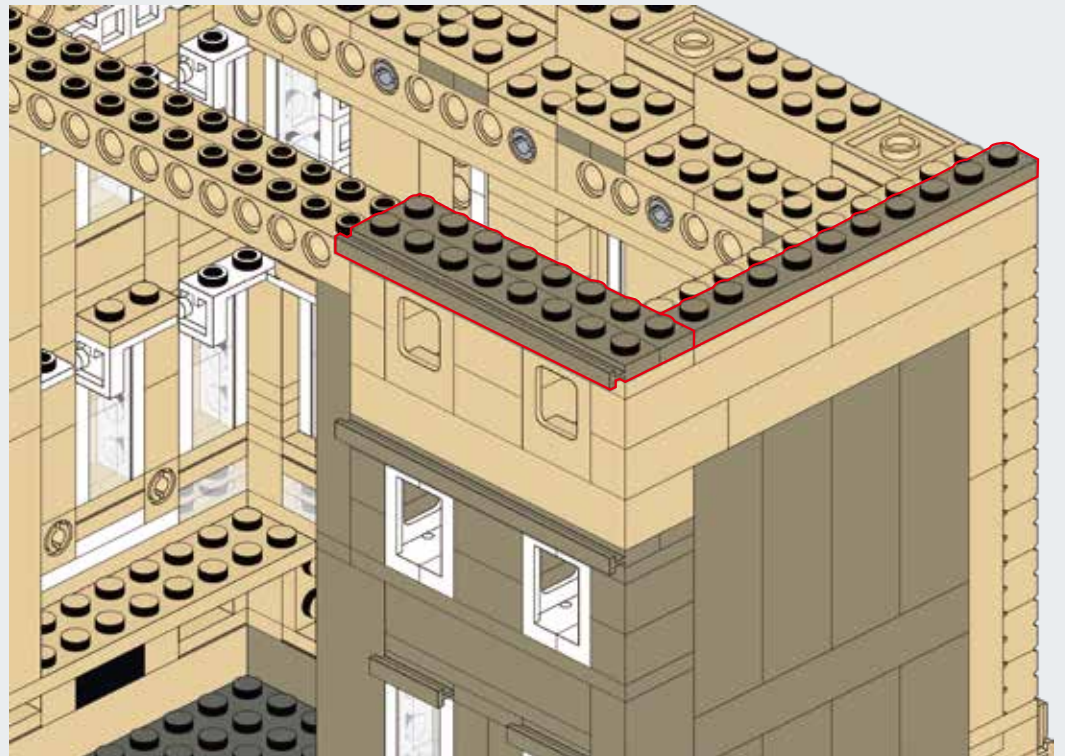

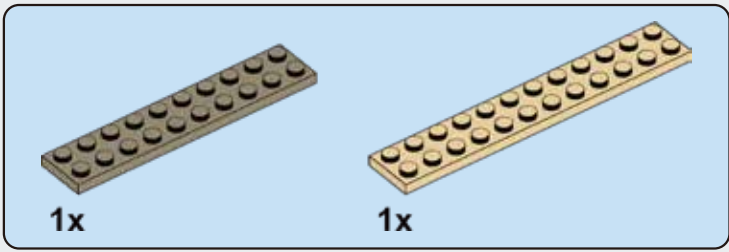

A167



A168



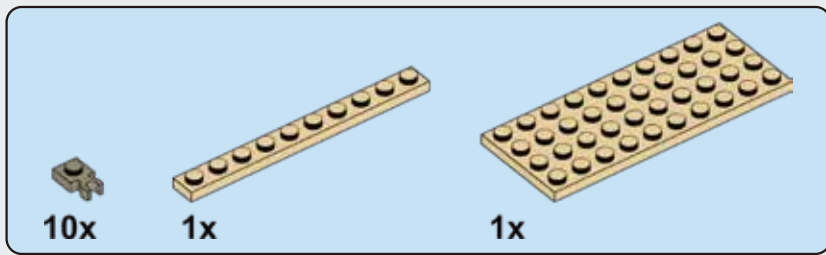

A169

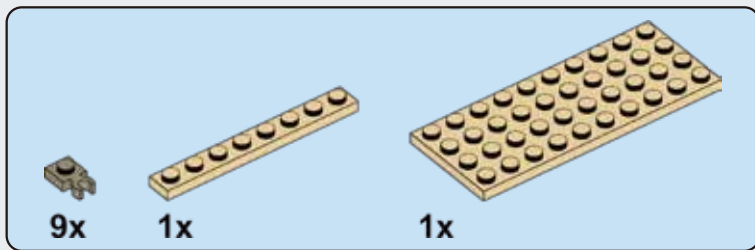
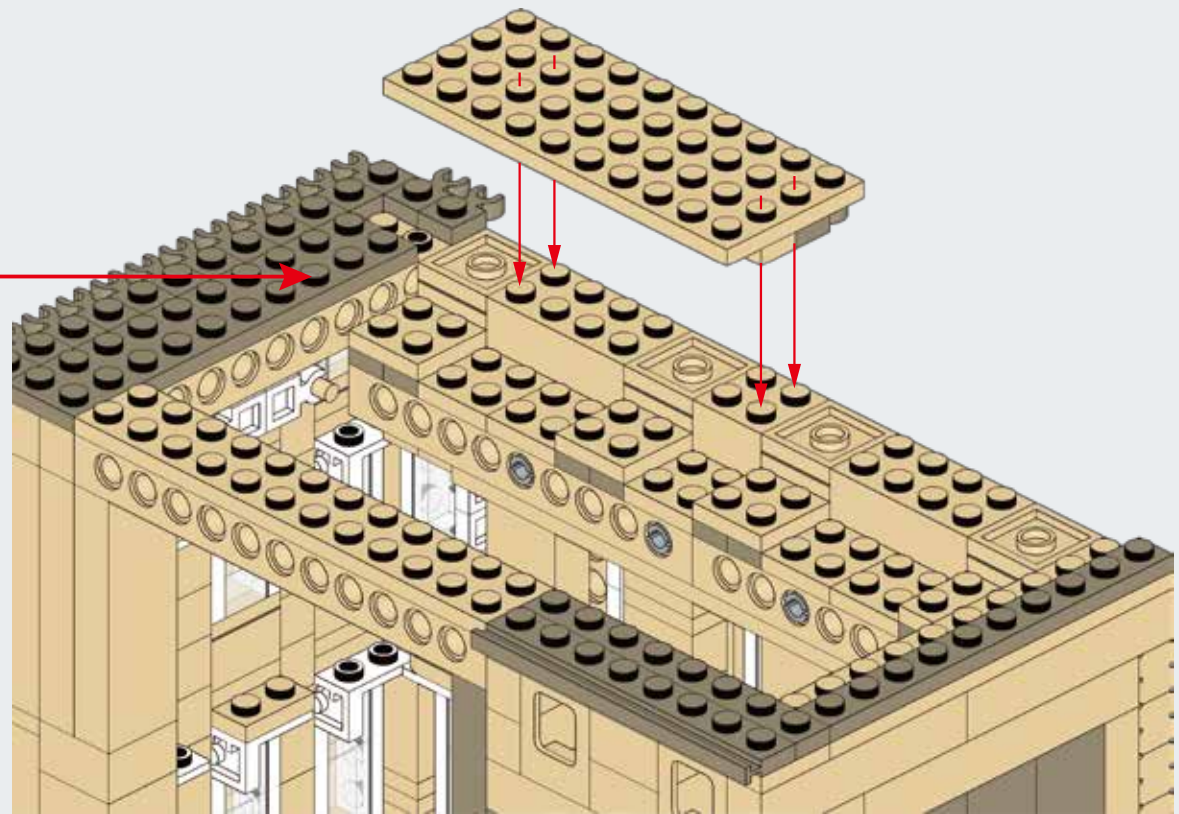
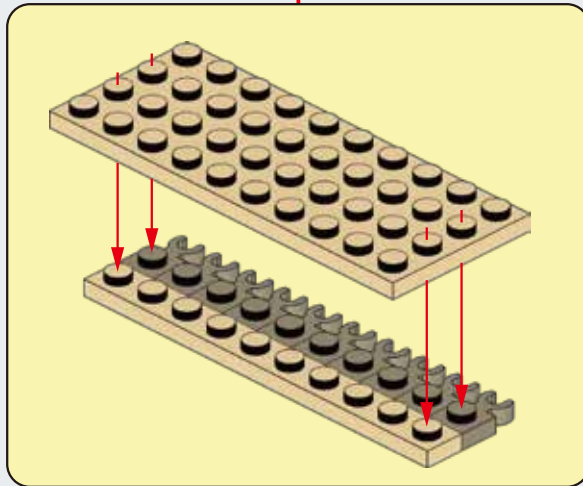

A170

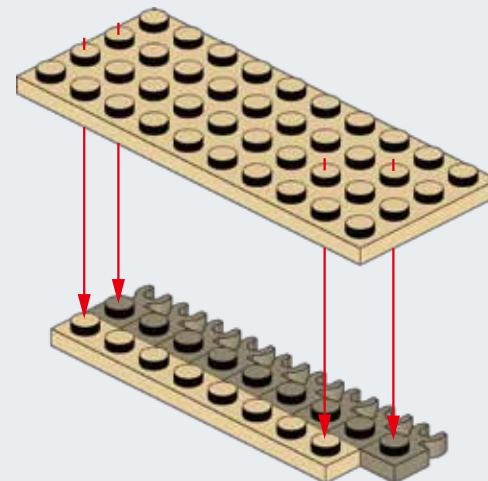

A171

A169

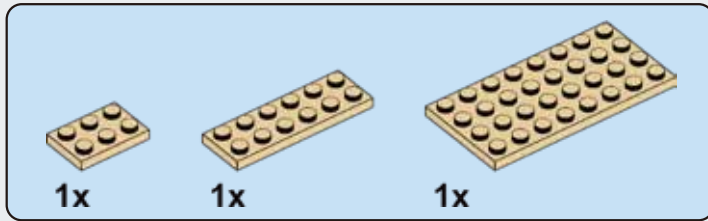
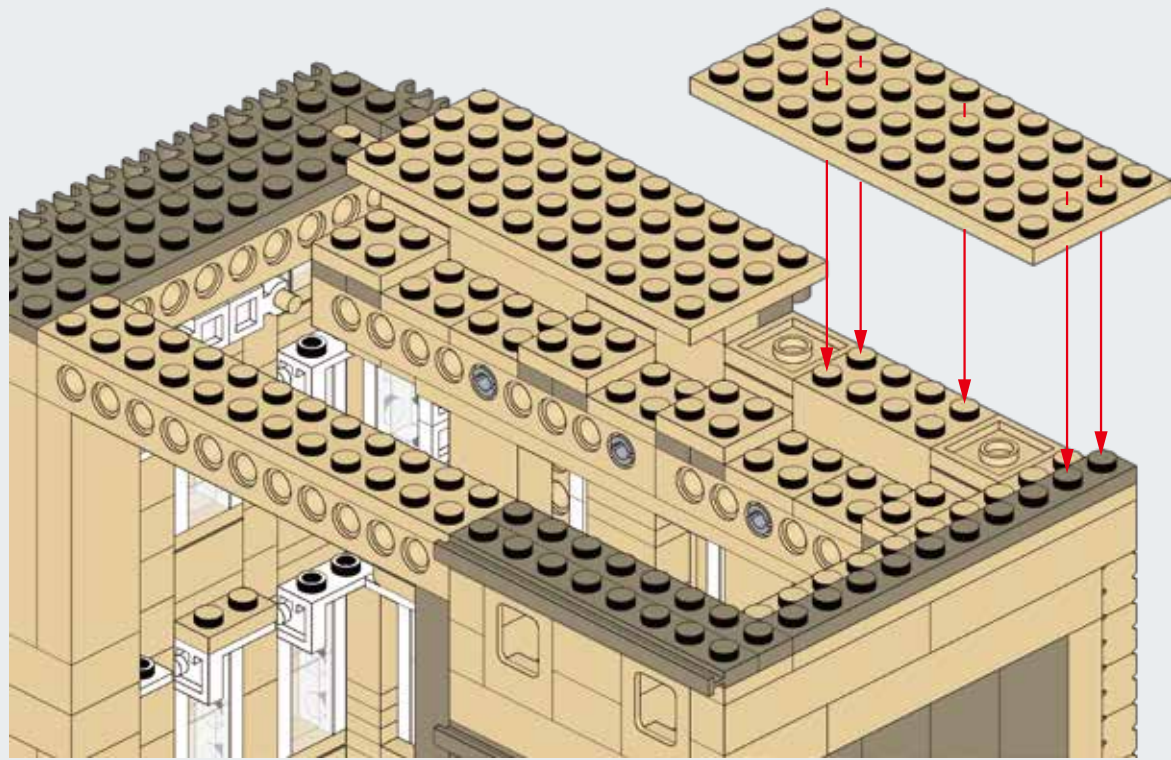

A172



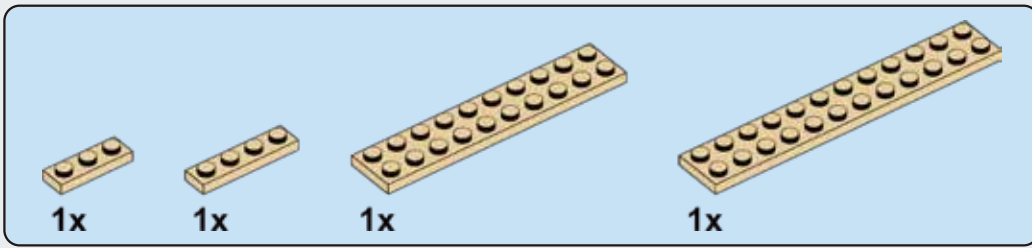

A173

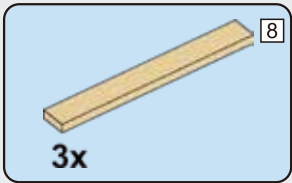
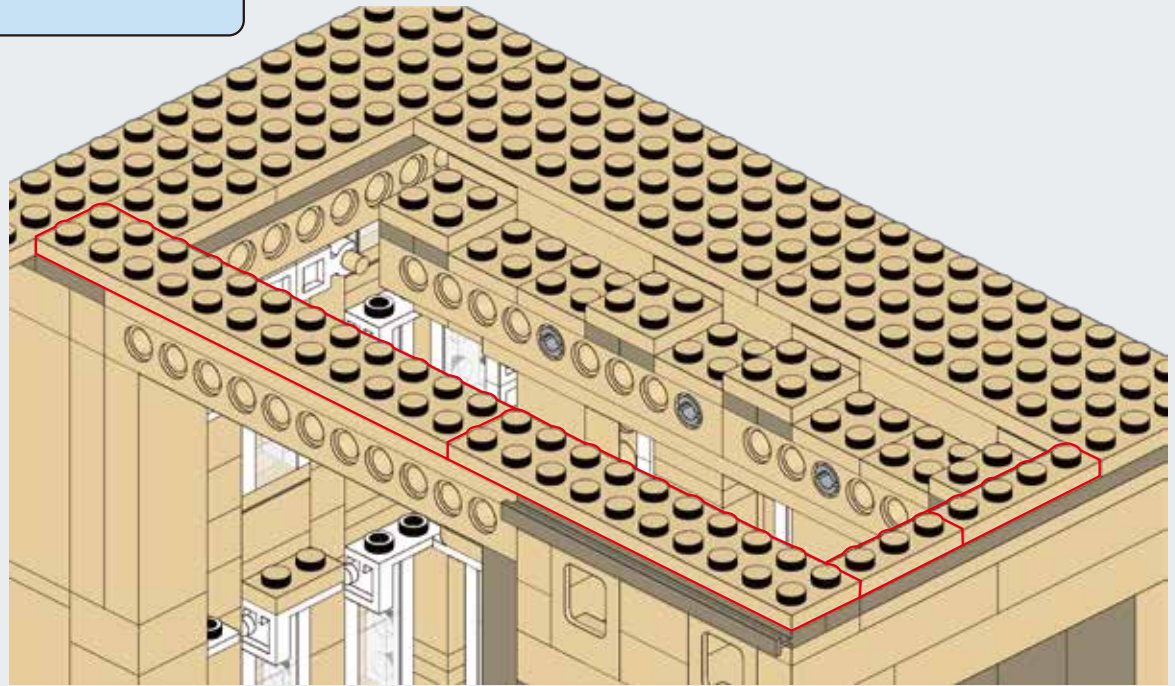

A174

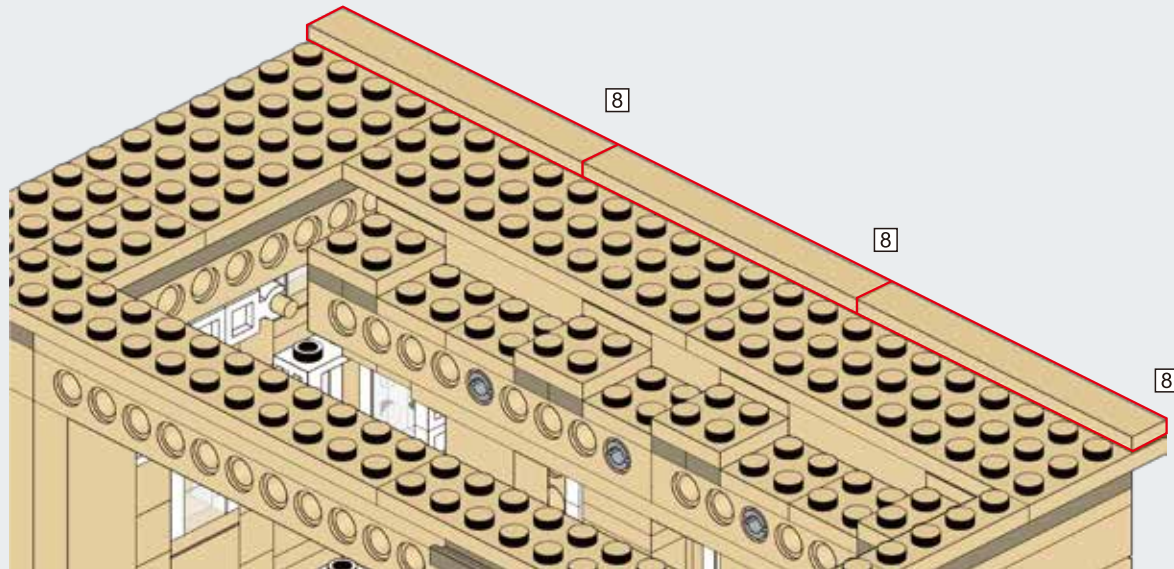



A175

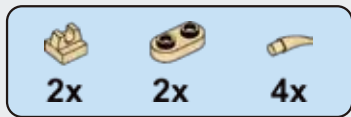
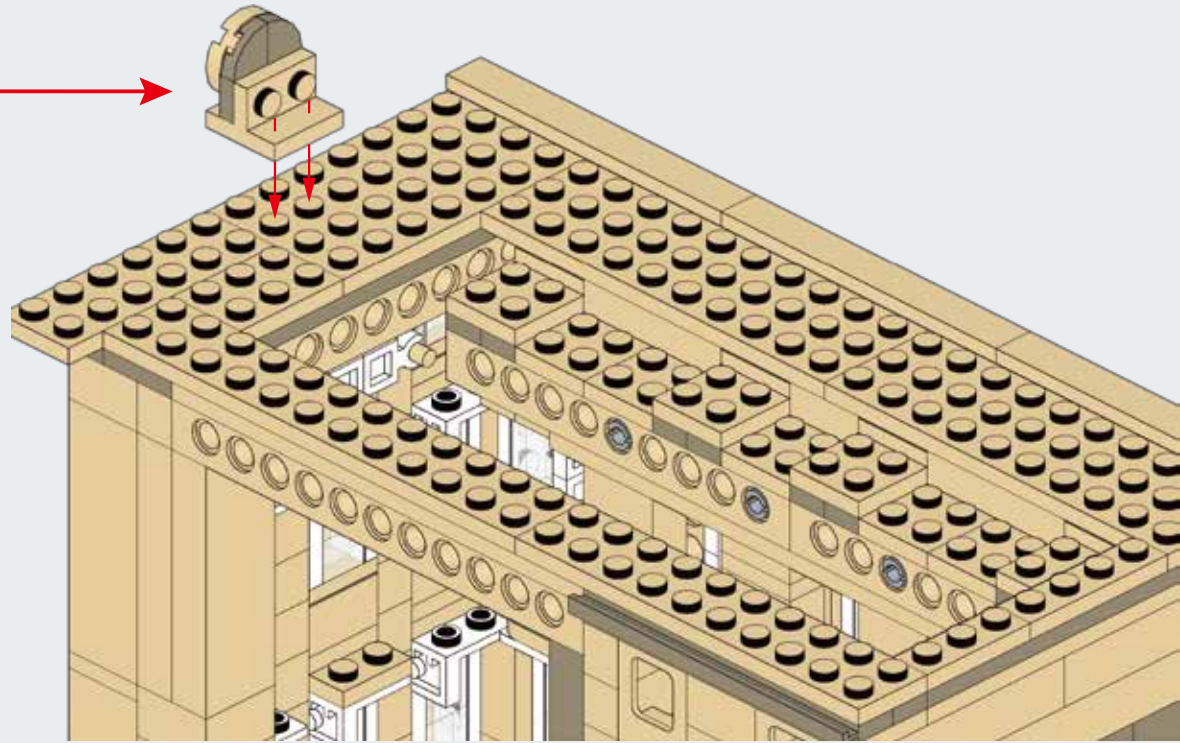
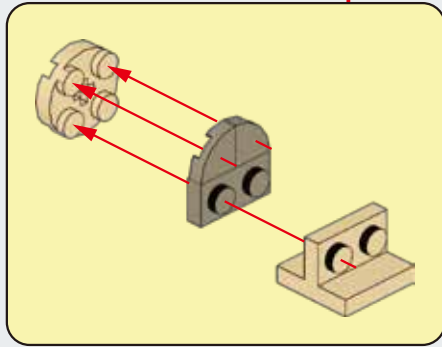

A176

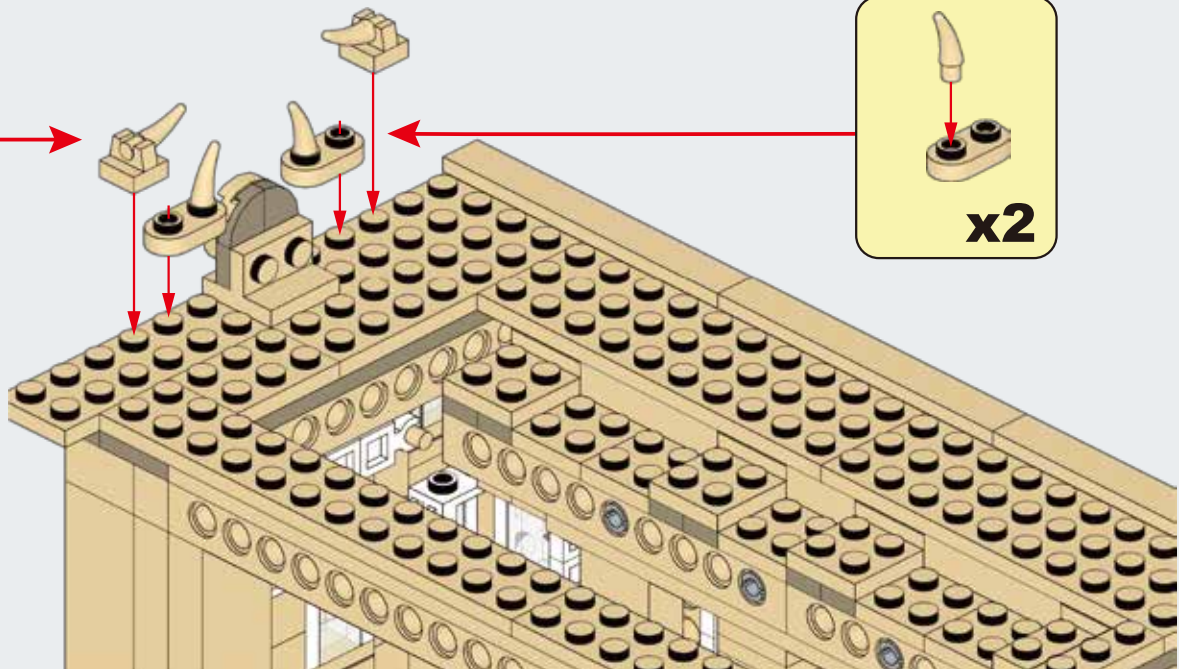
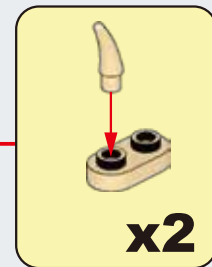
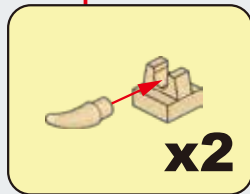

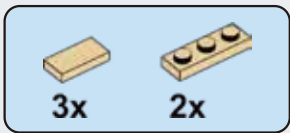

A177

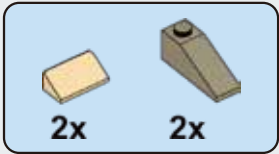
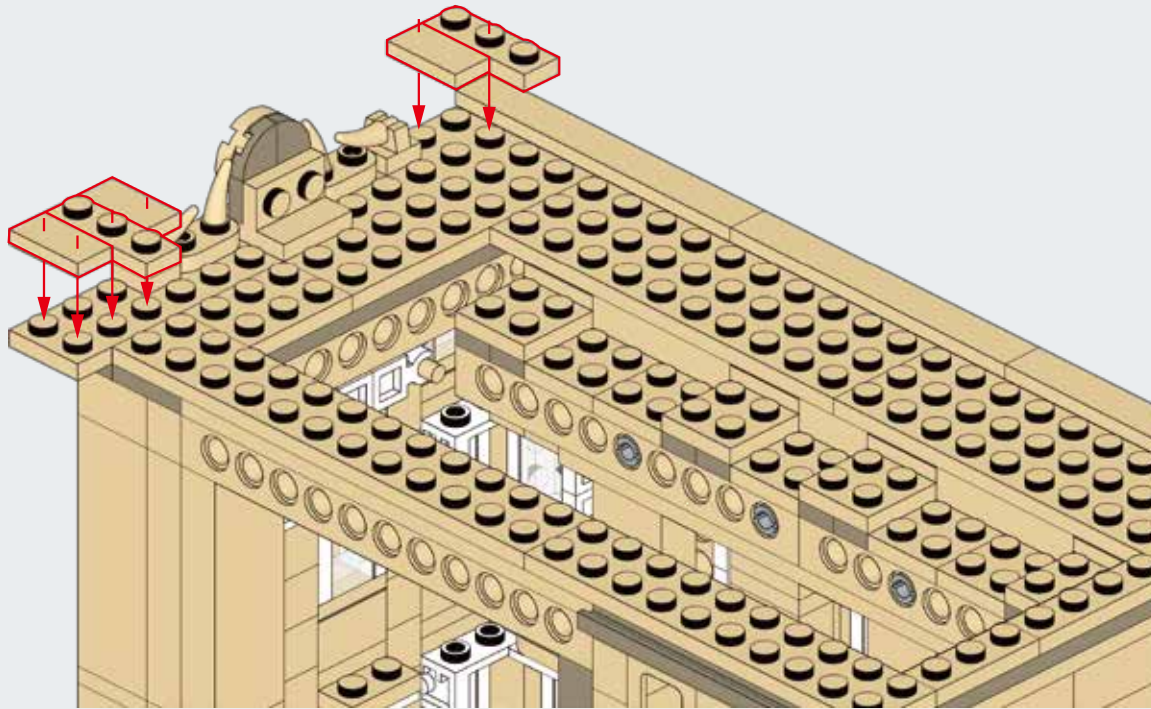

A178

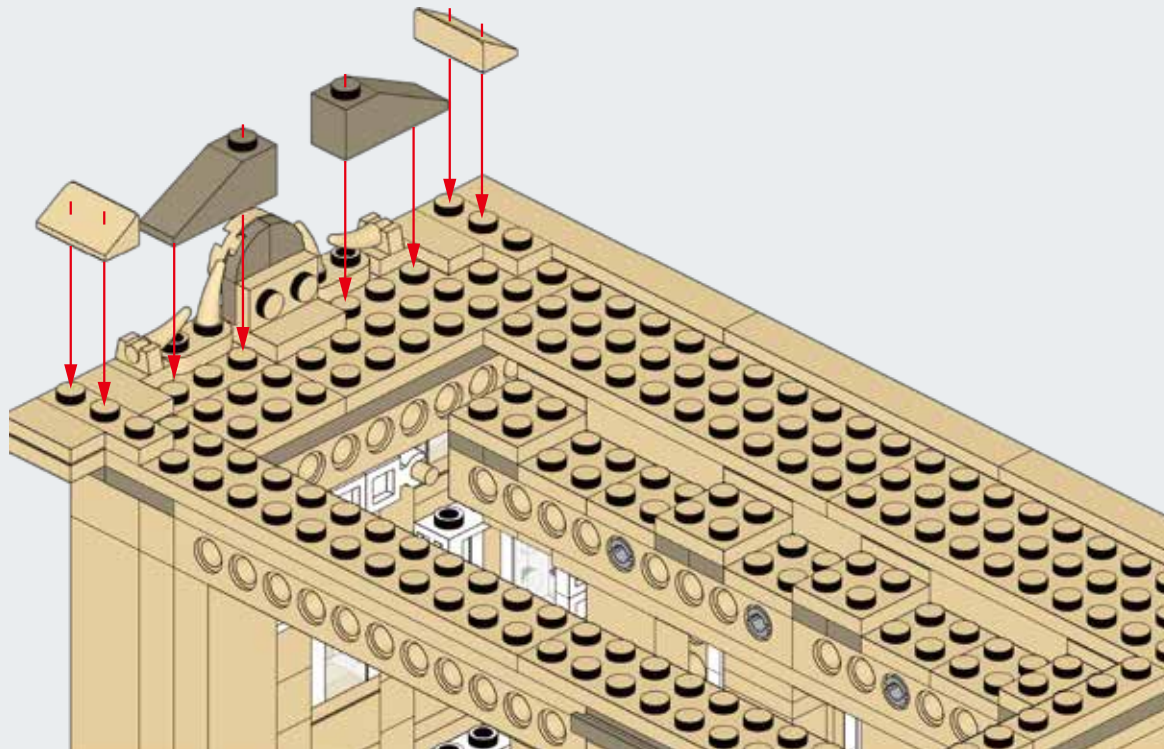

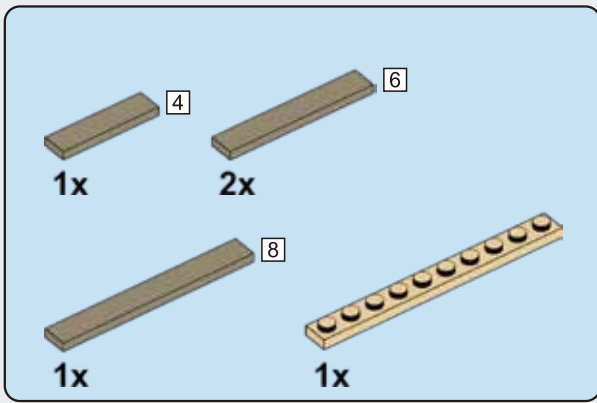

A179

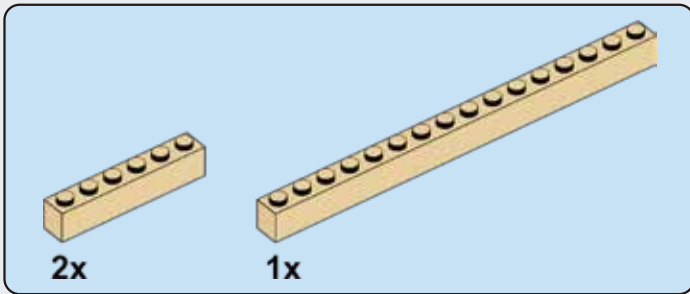
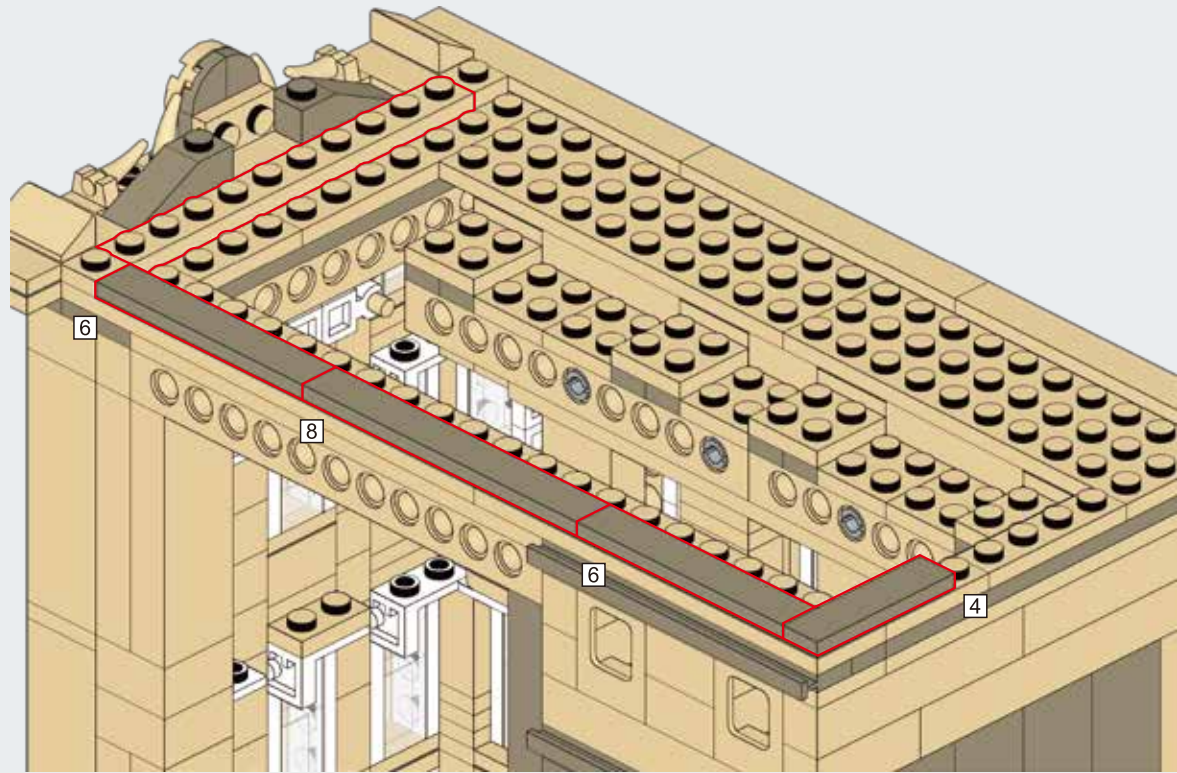

A180

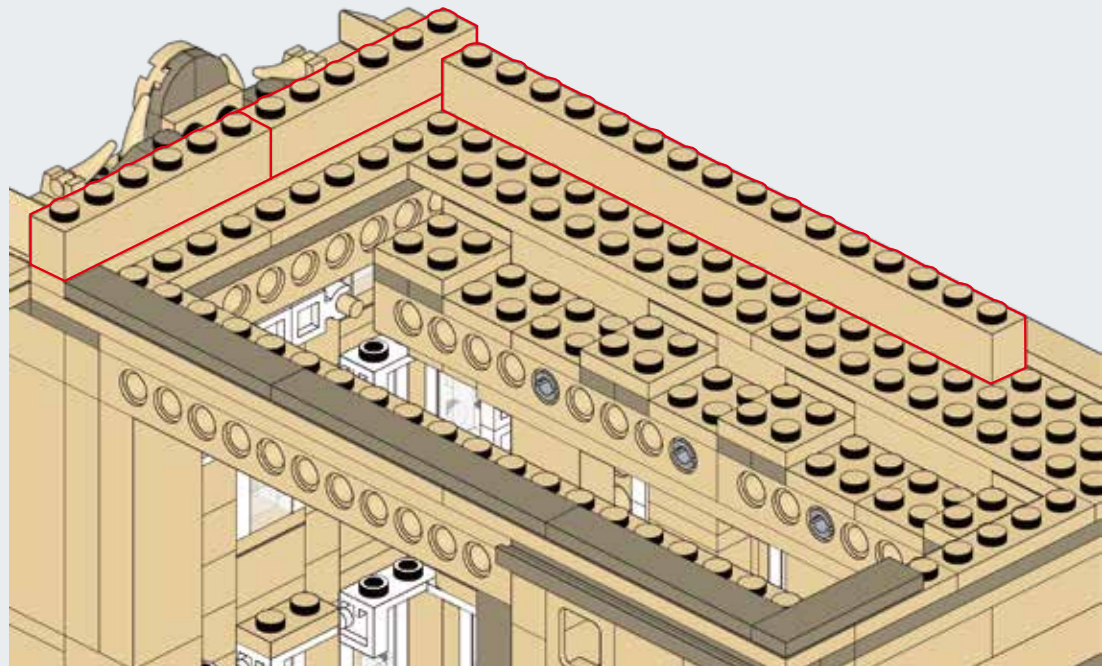

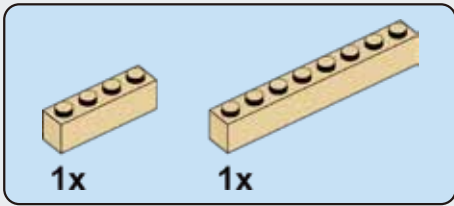

A181

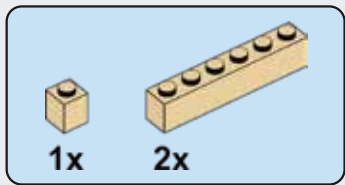
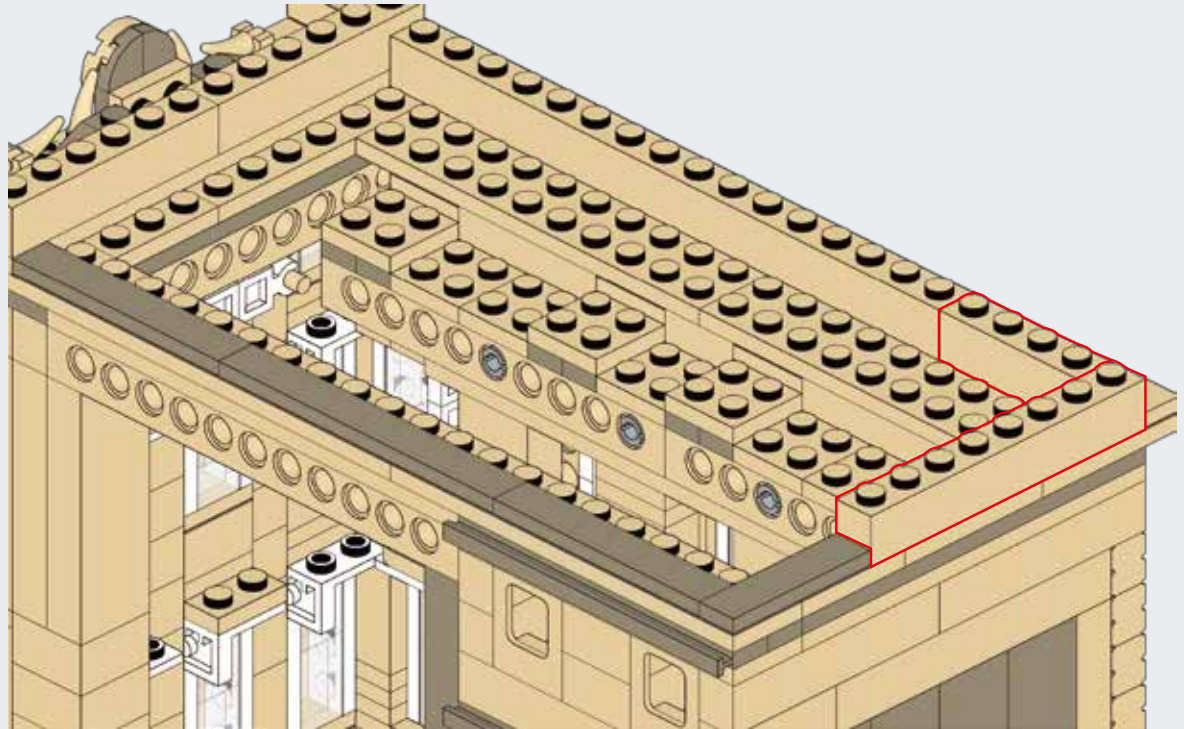

A182

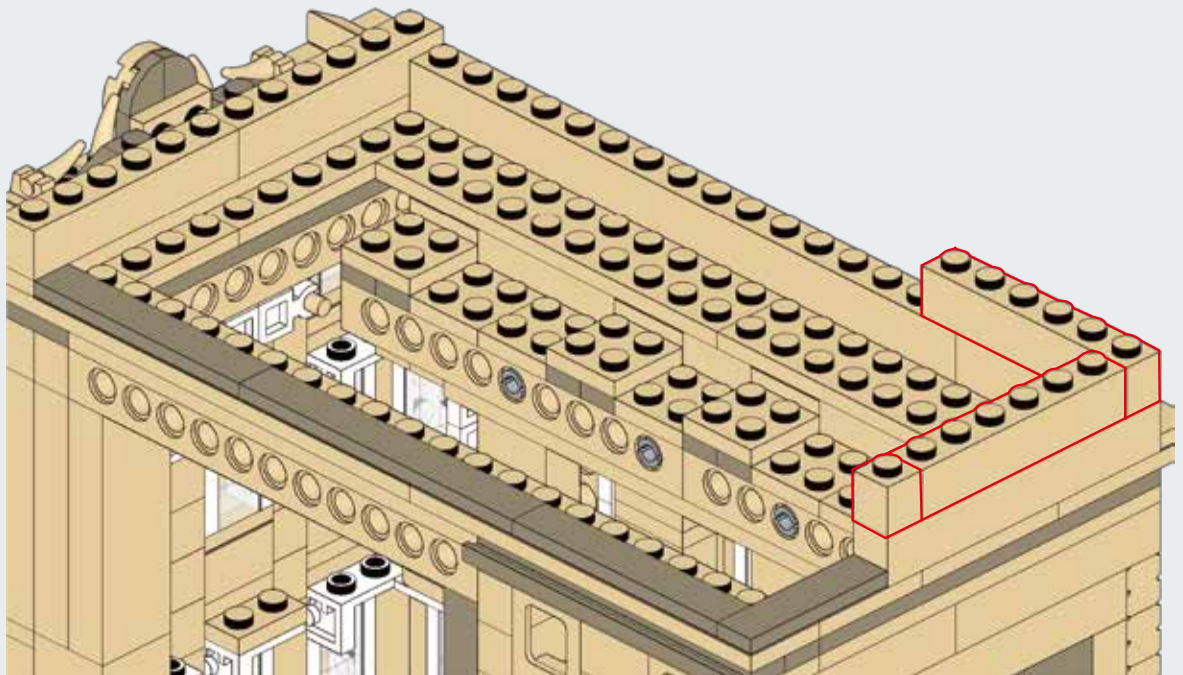

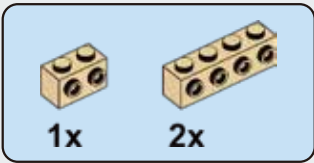

A183

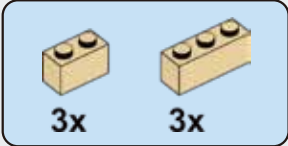
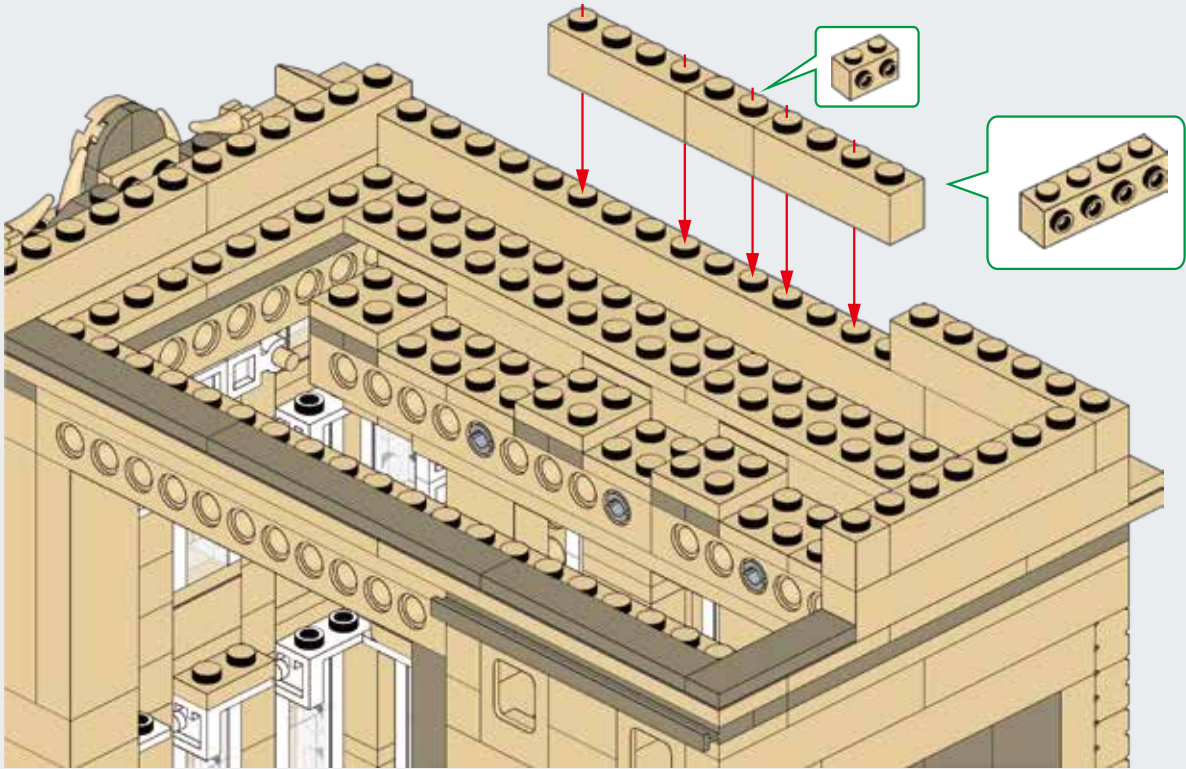

A184

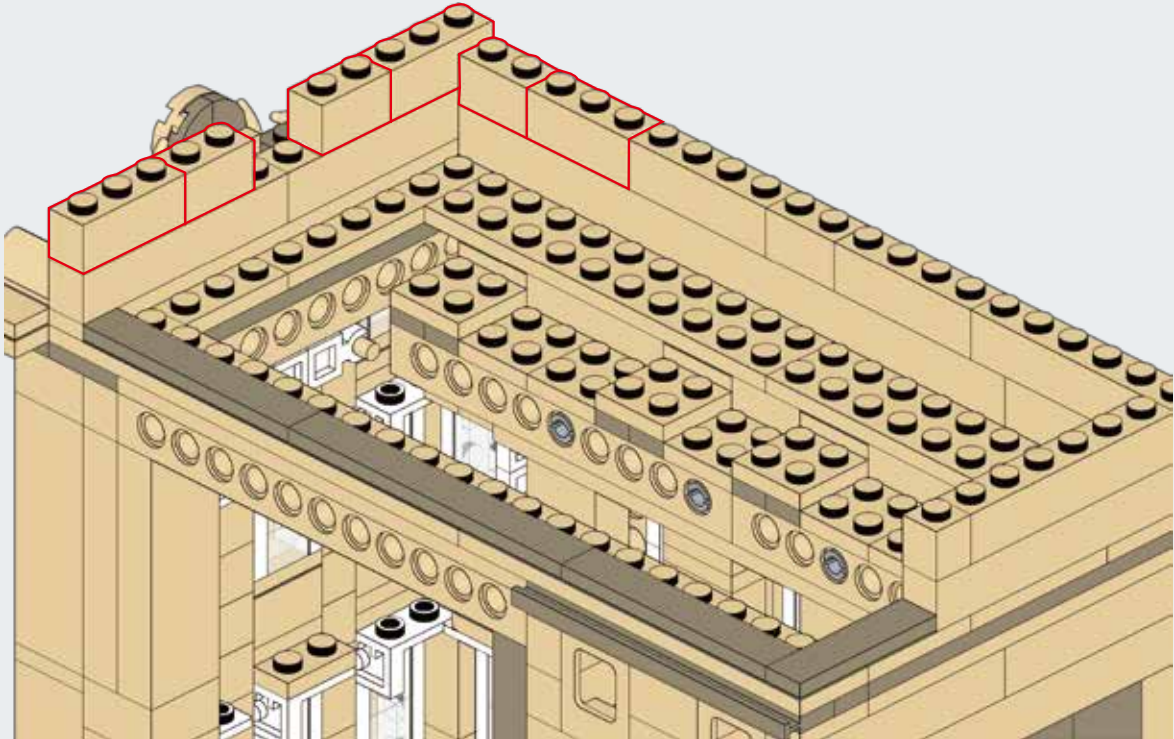

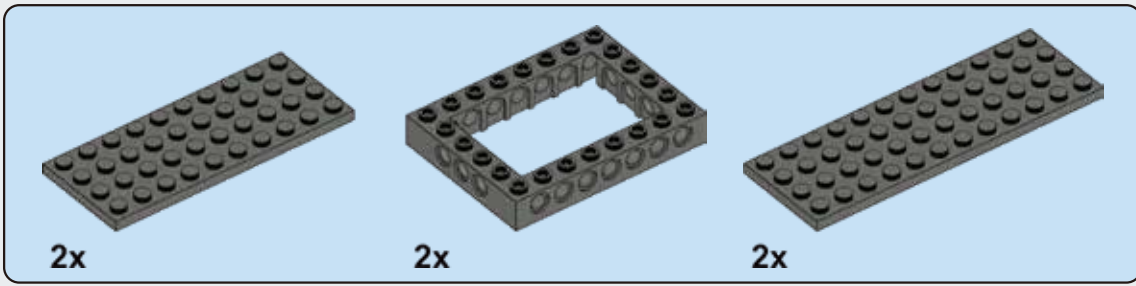

A185

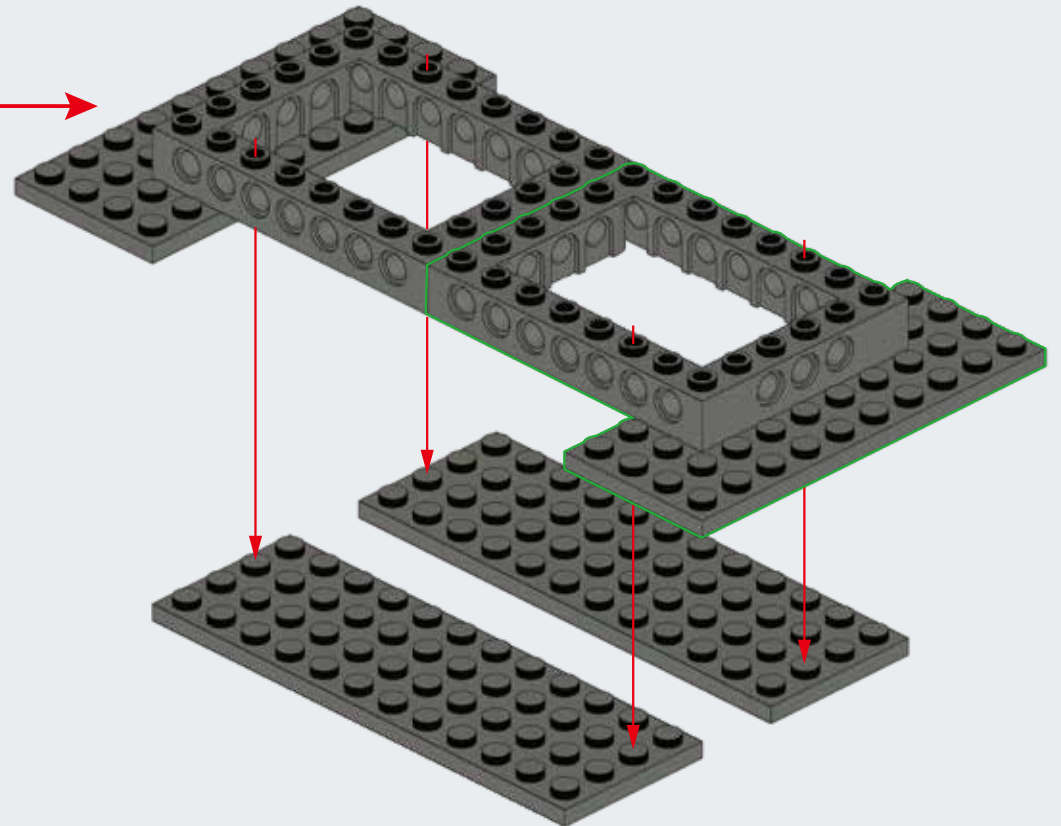
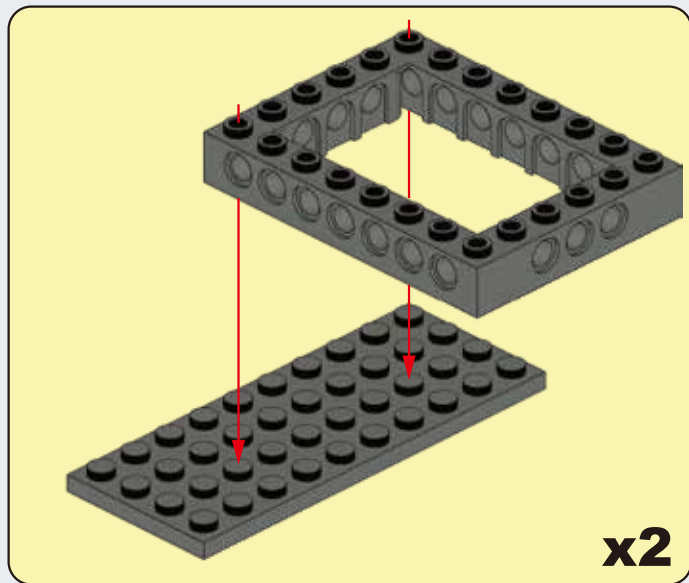

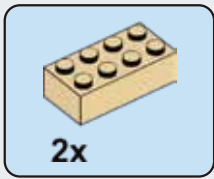

A186

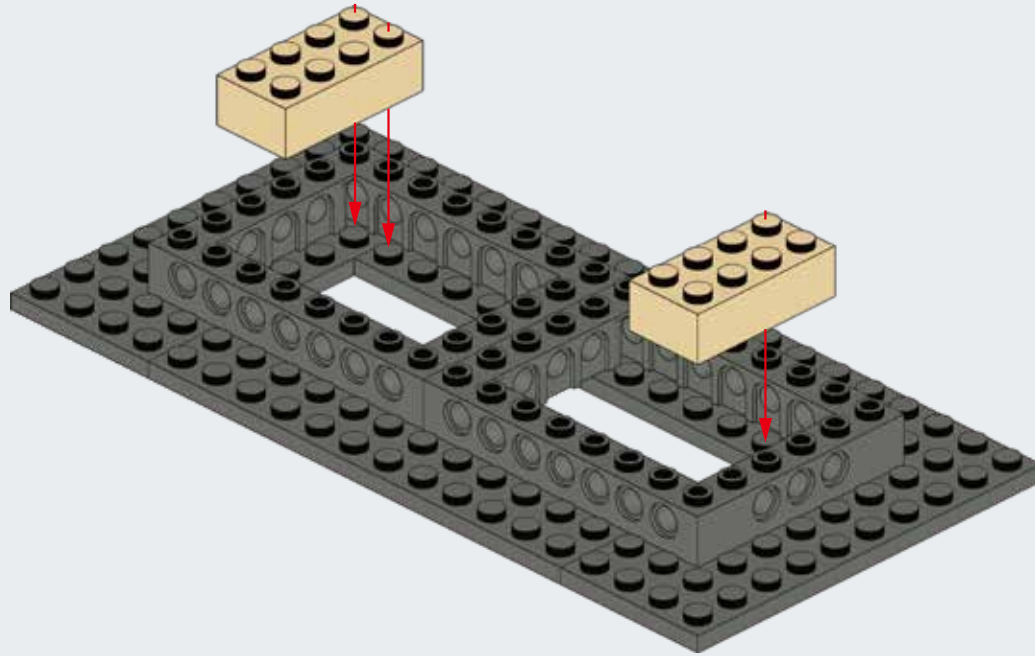

A187

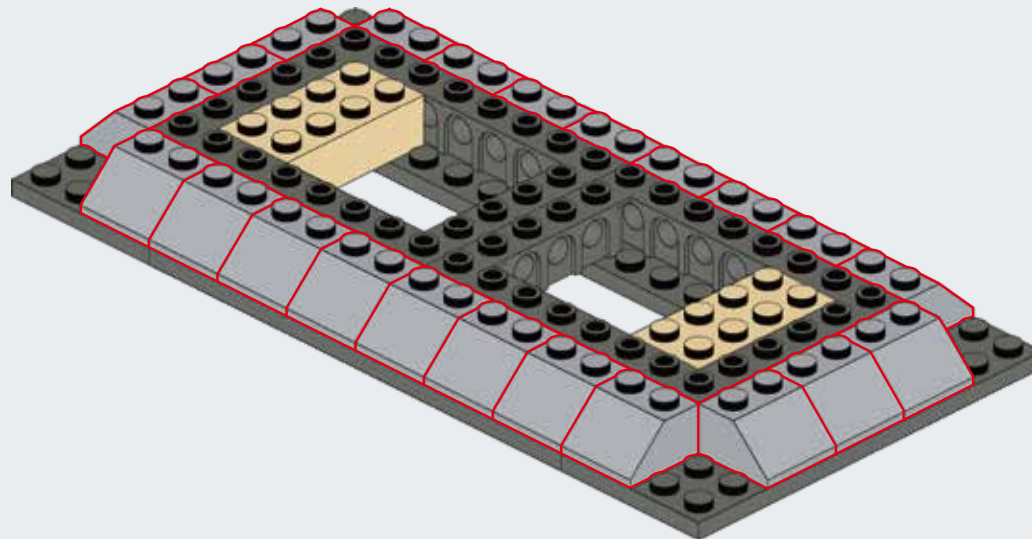



A188

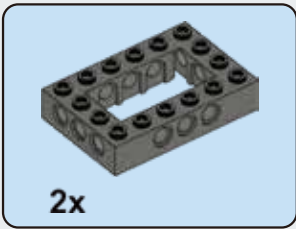
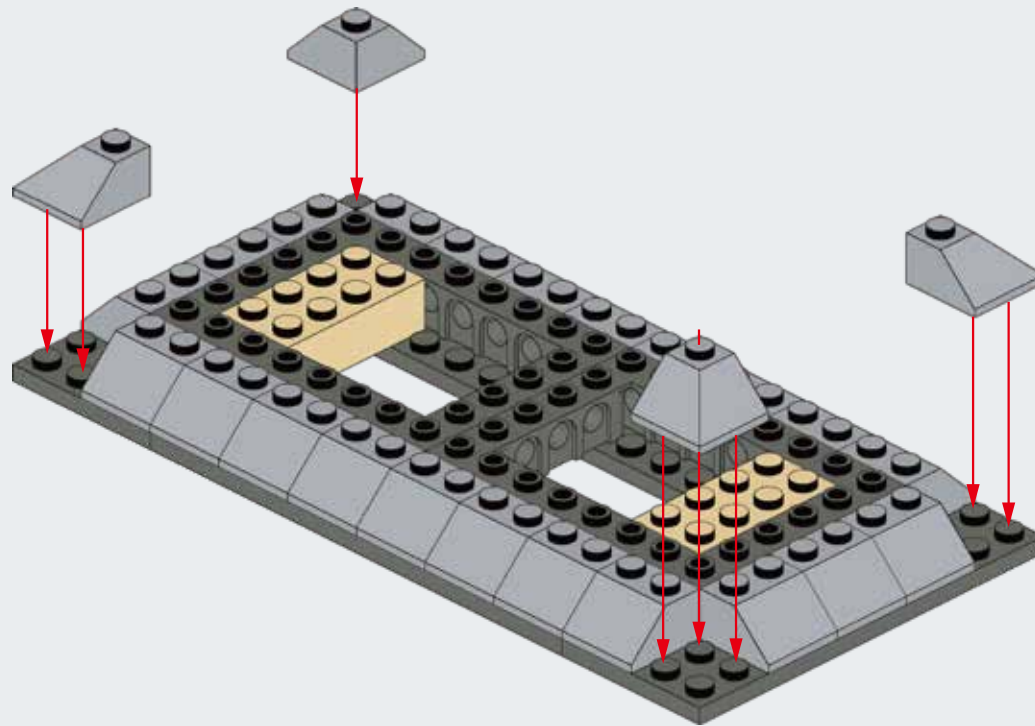

A189

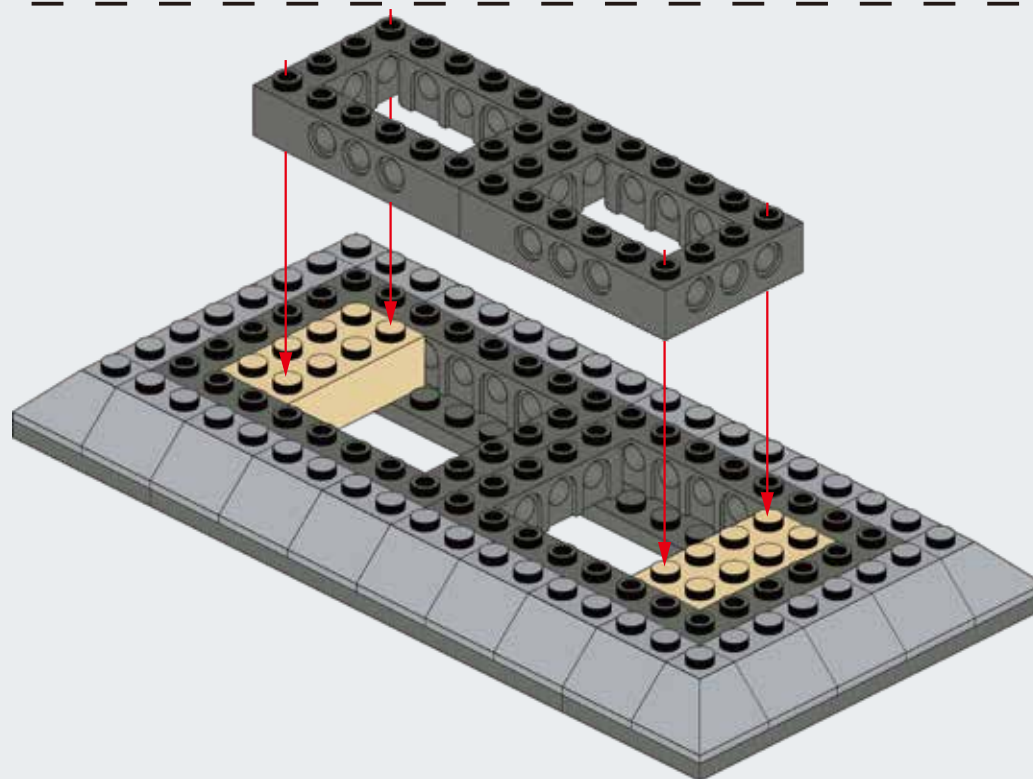



A190

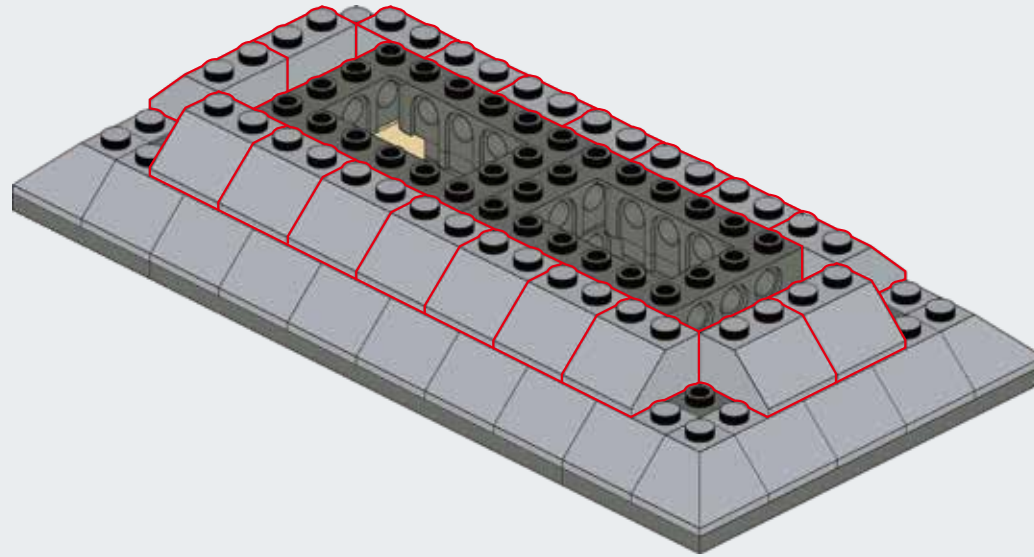

A191

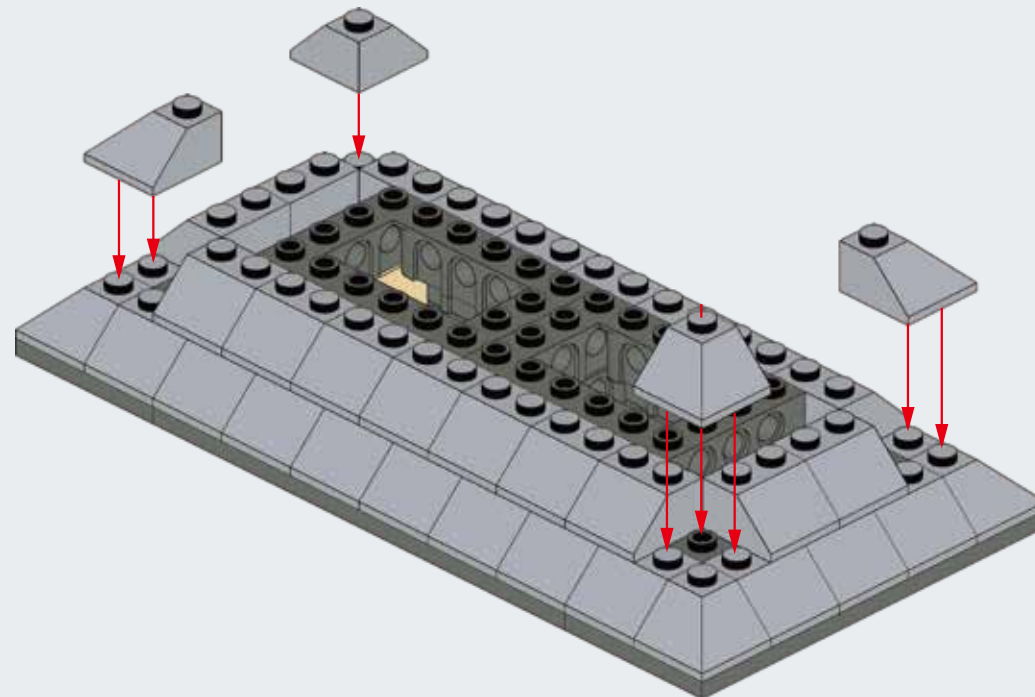

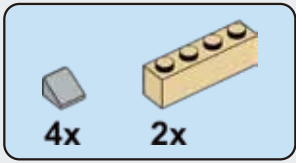

A192

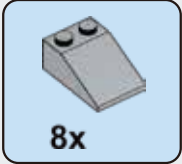
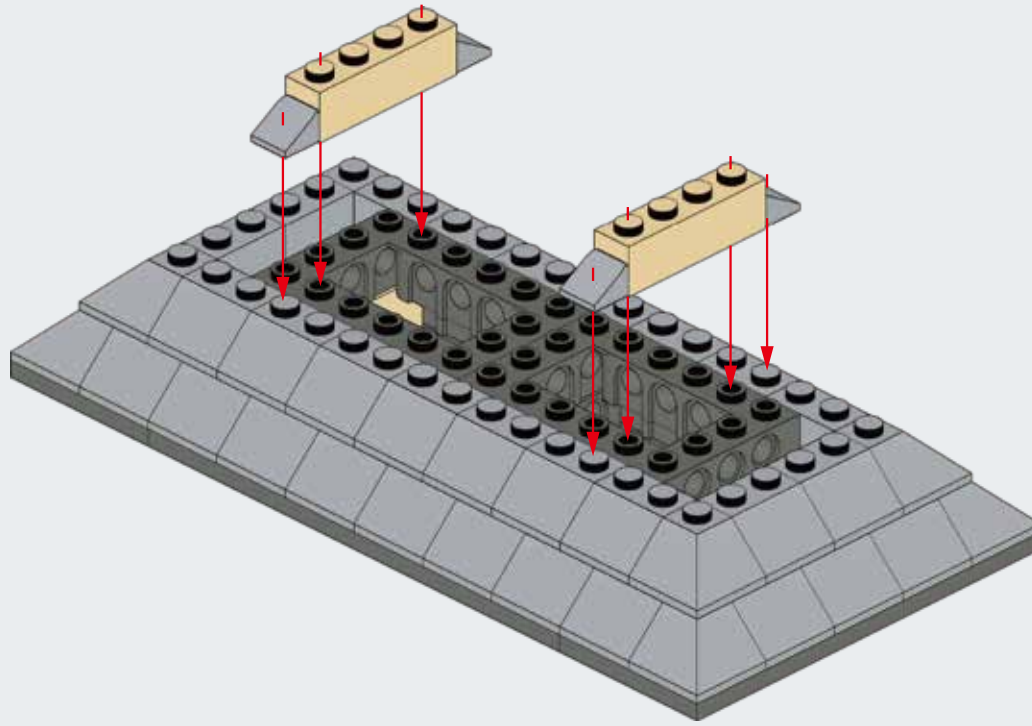

A193

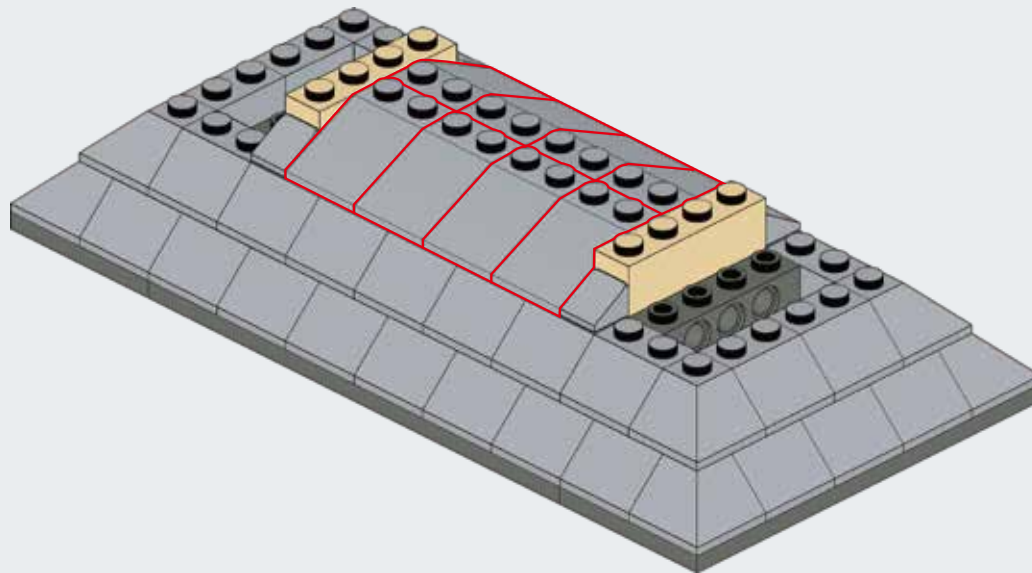

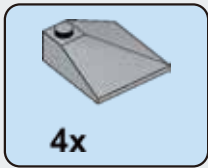

A194

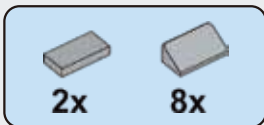
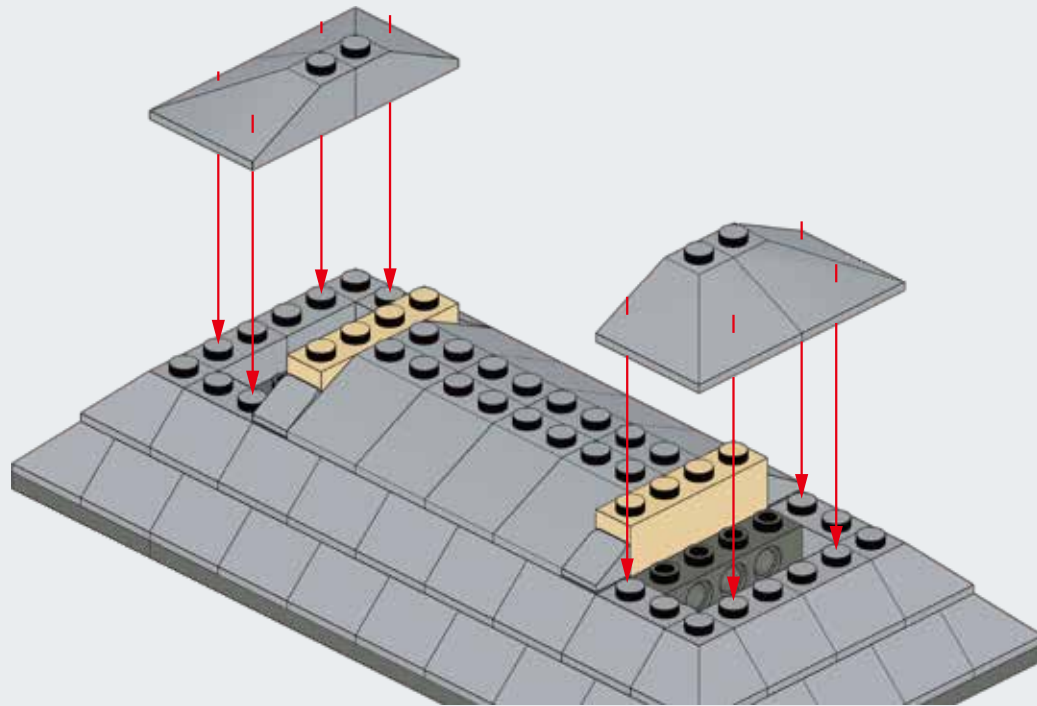

A195

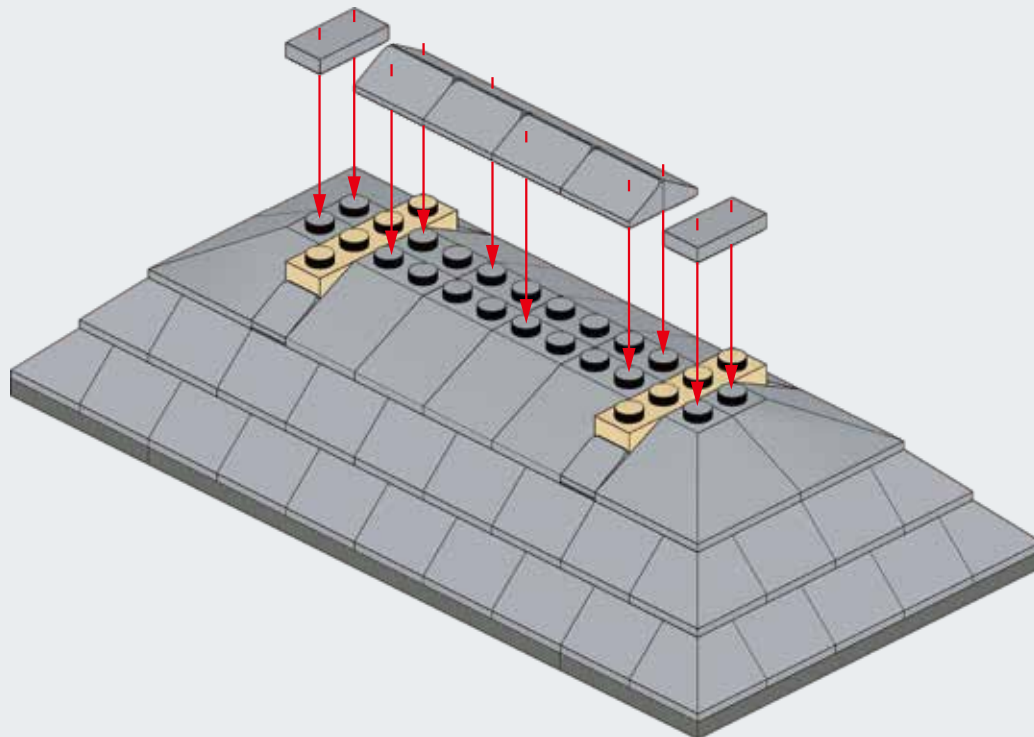

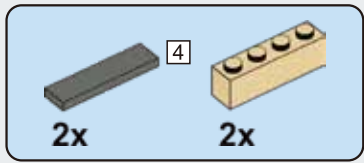

A196

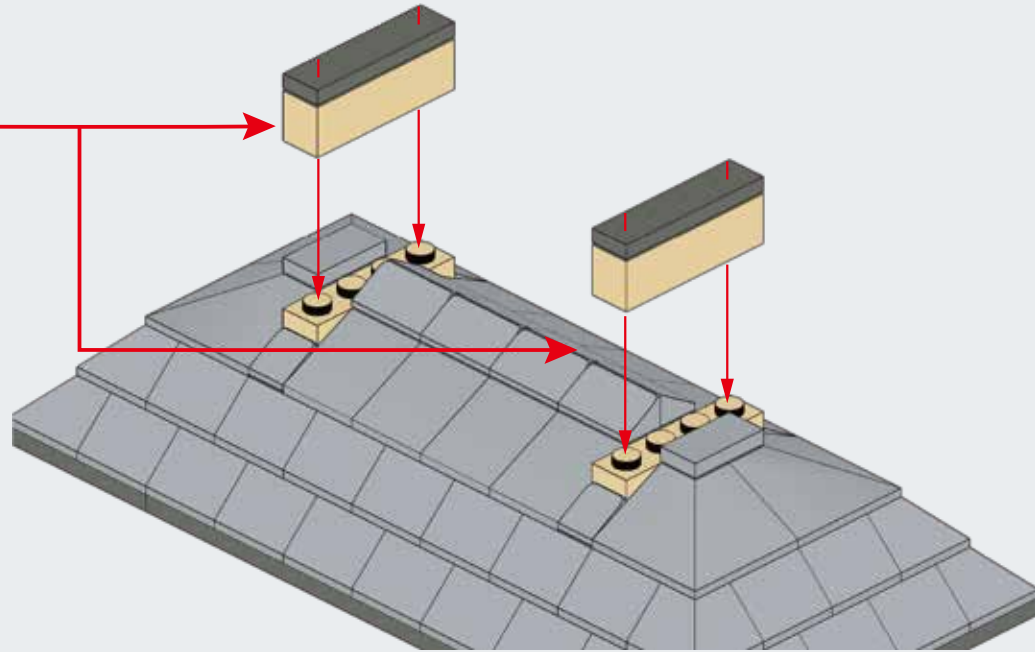
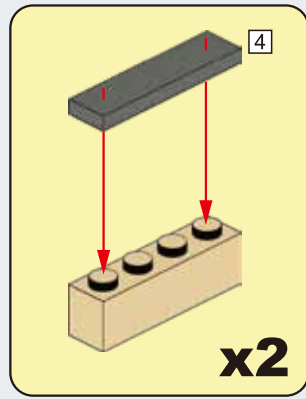

A197

A184 →

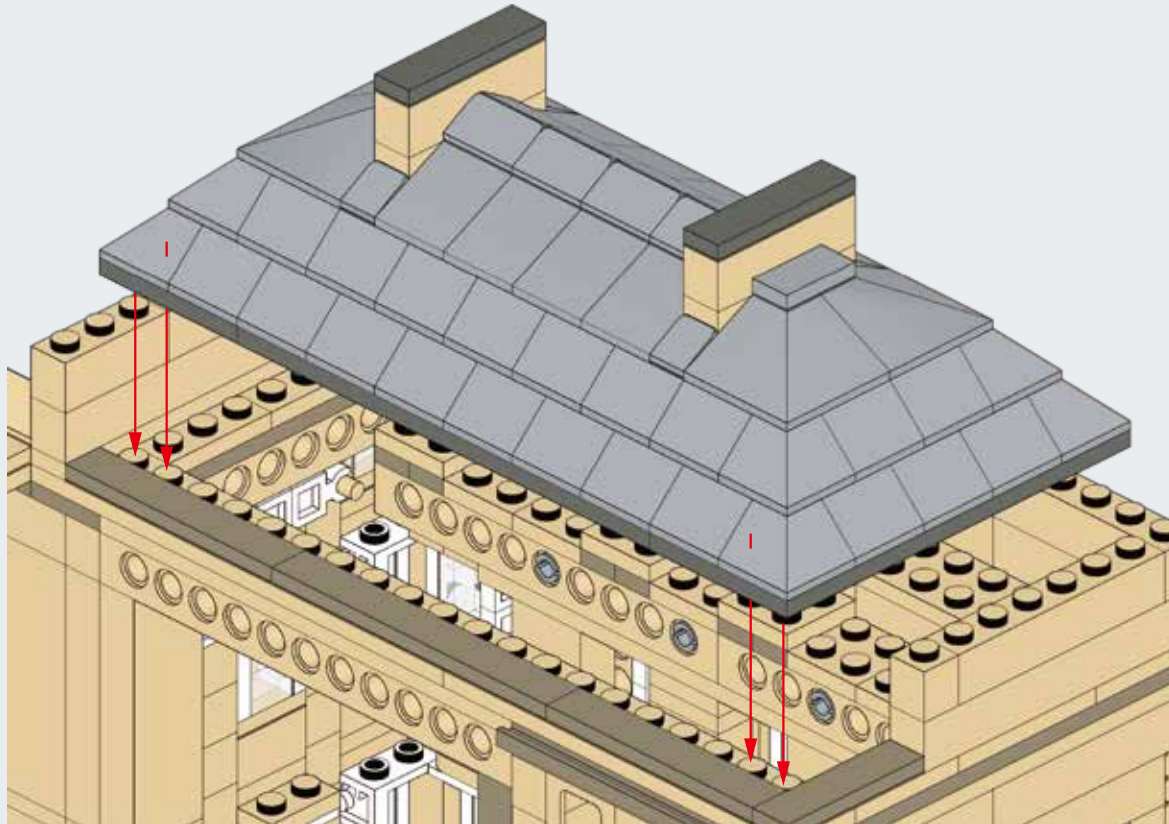

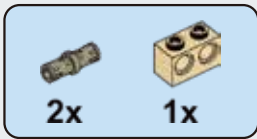

A198

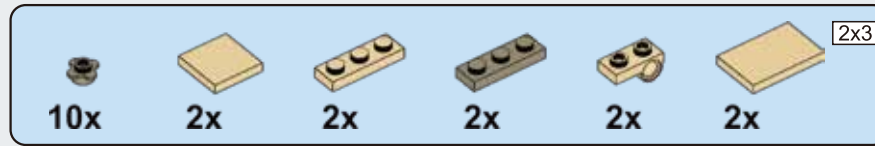
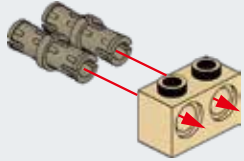

A199

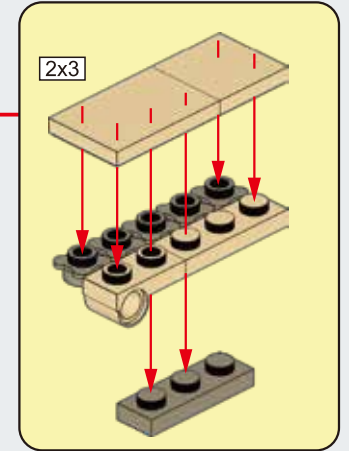
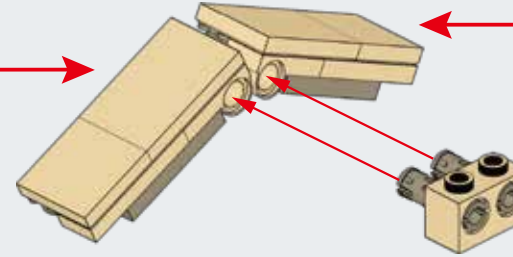
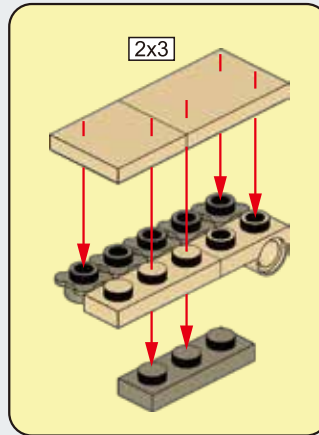

A200

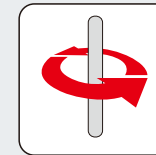
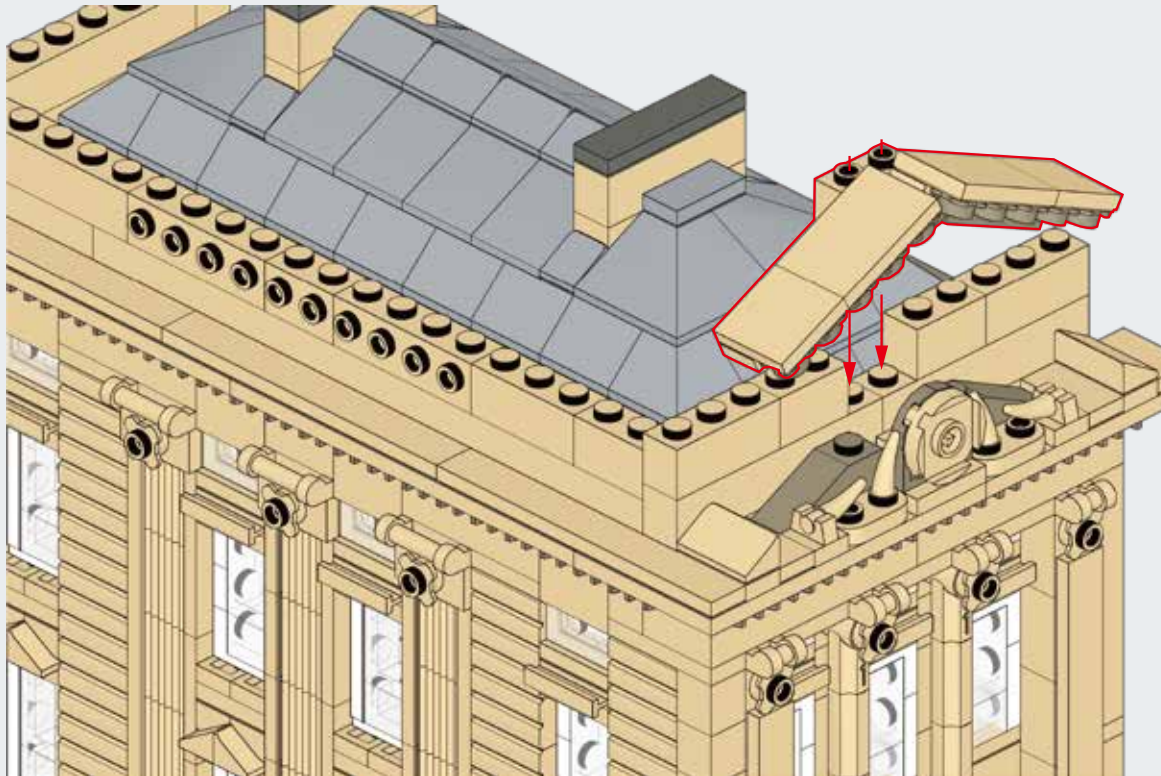

A197 →

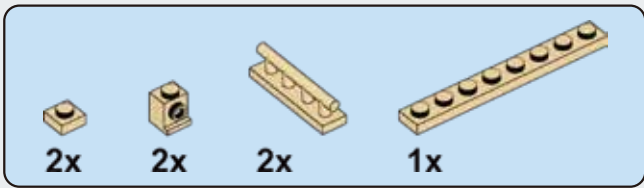

A201

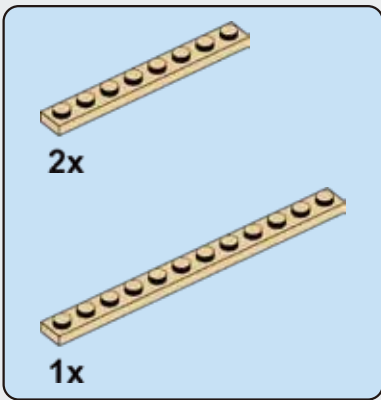
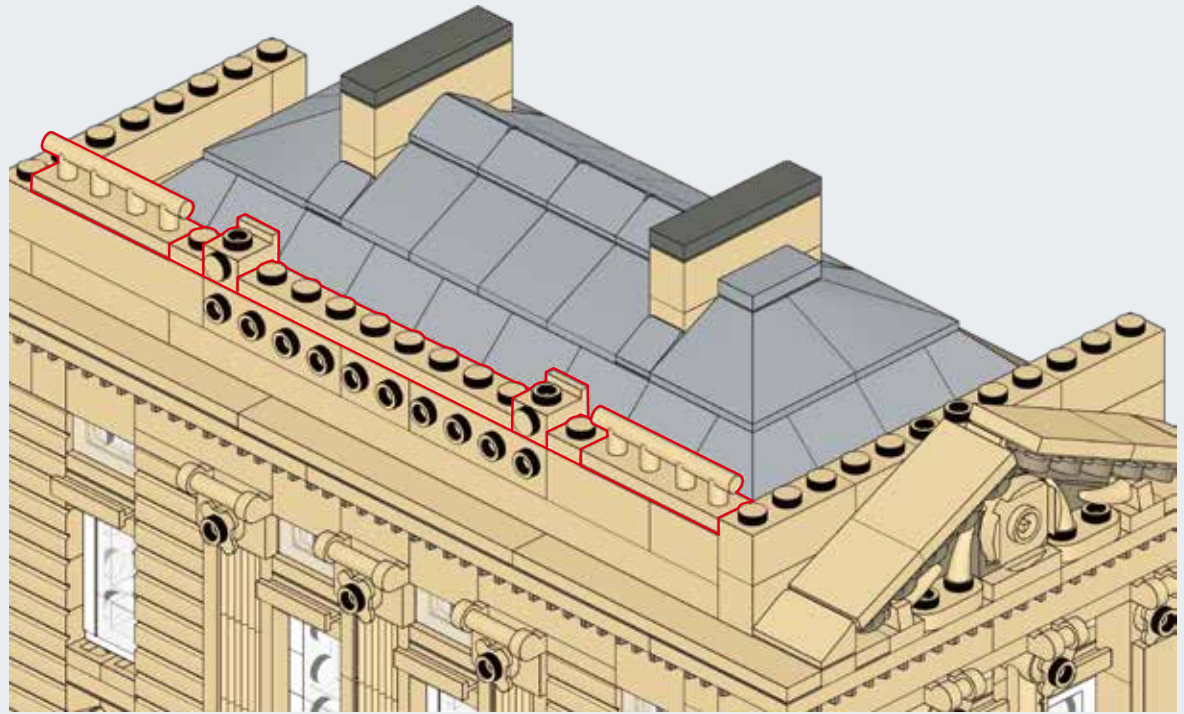

A202

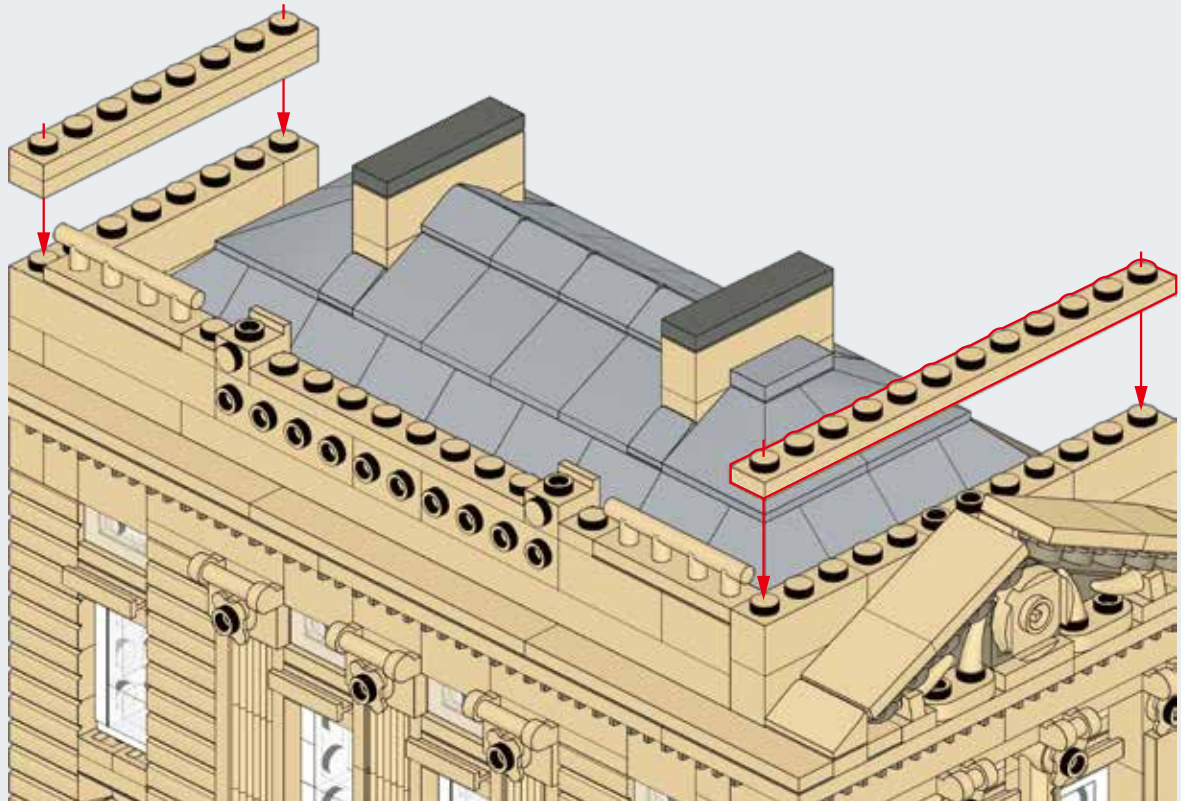
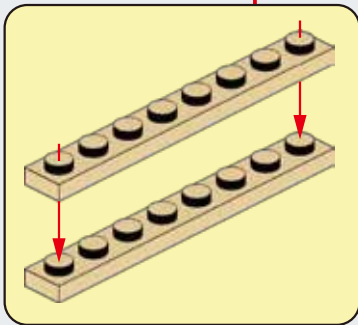

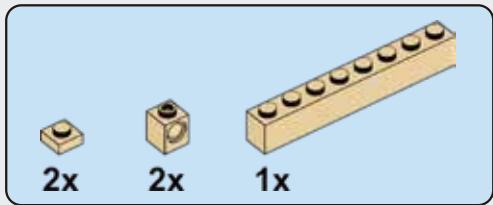

A203

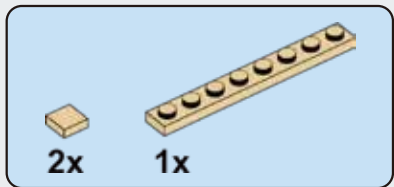
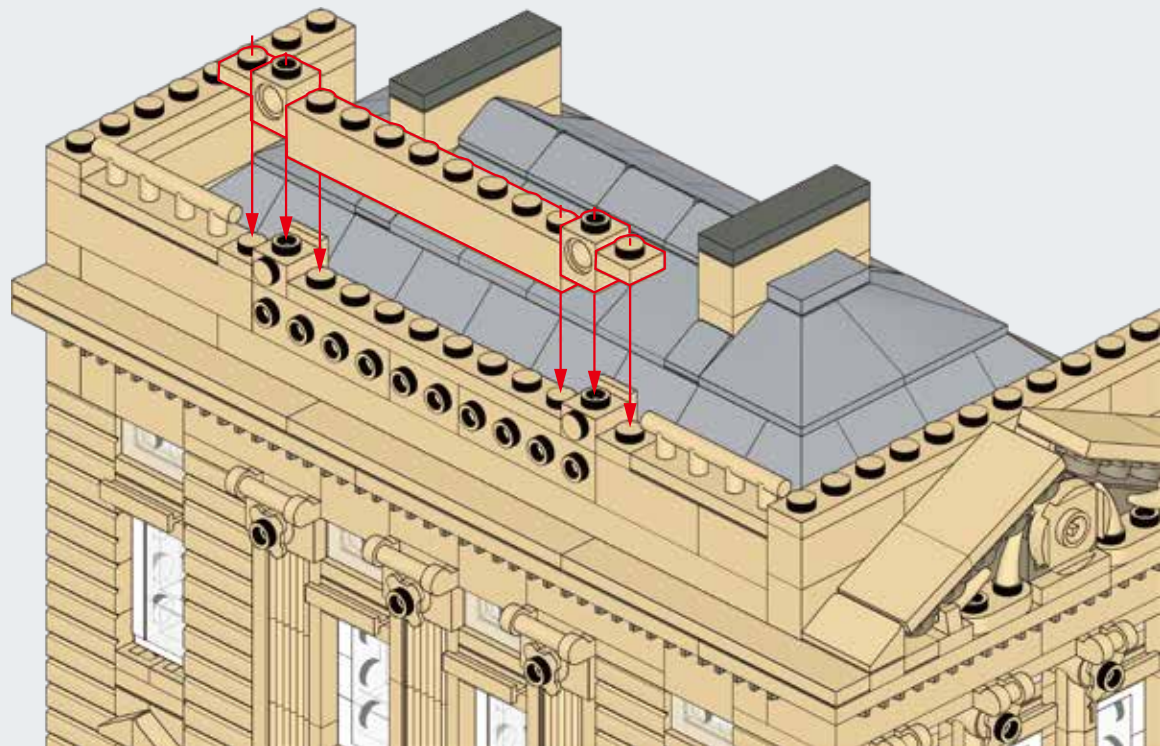

A204

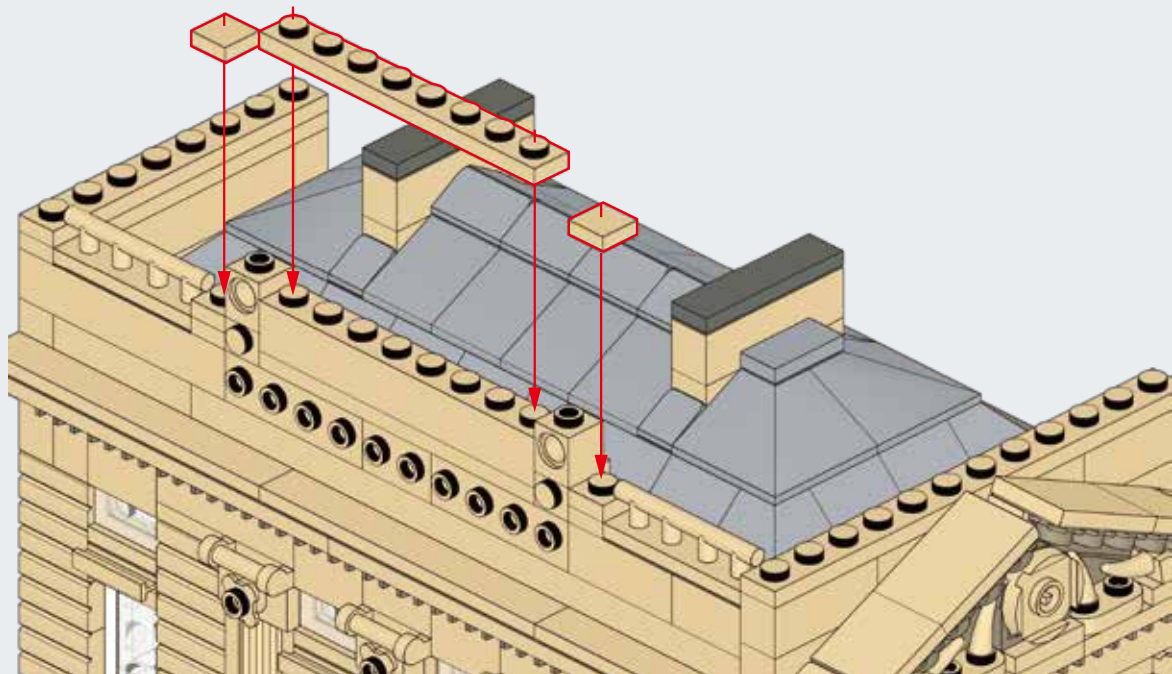

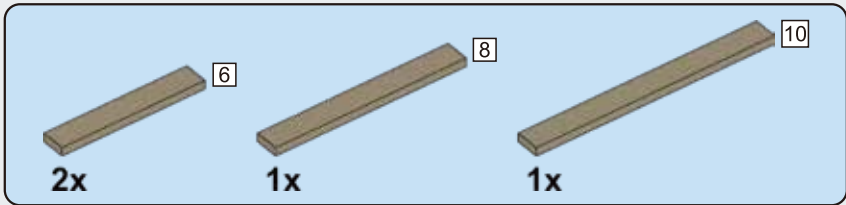

A205

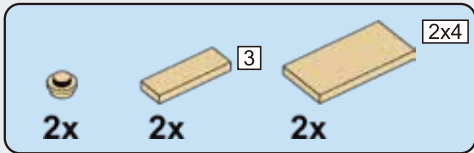
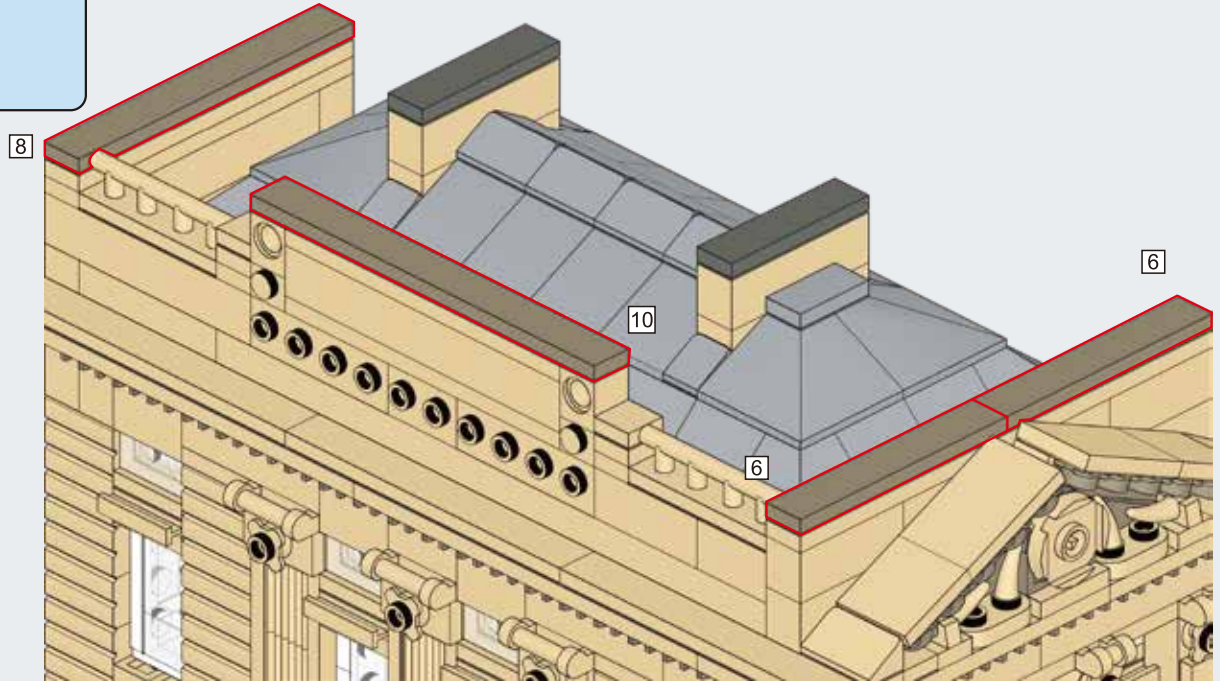

A206

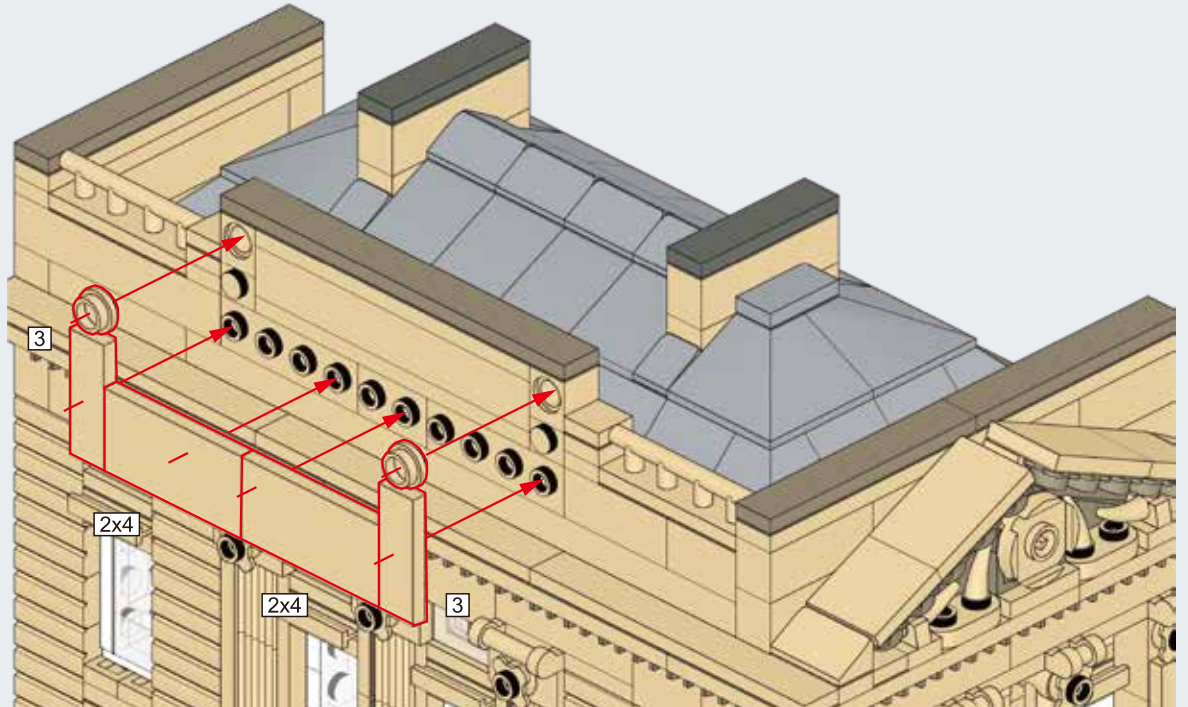

B

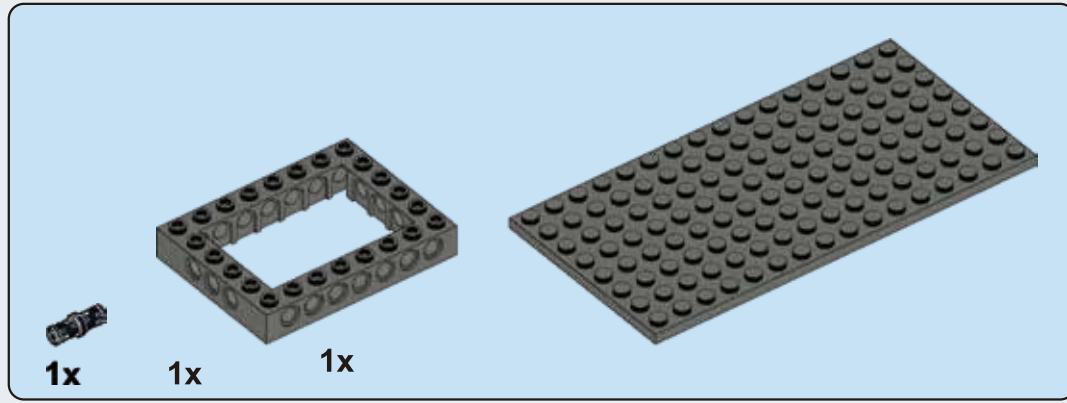
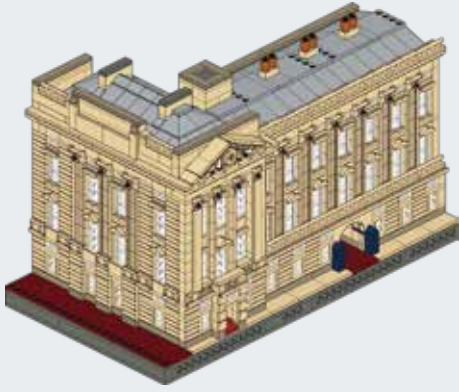

B1

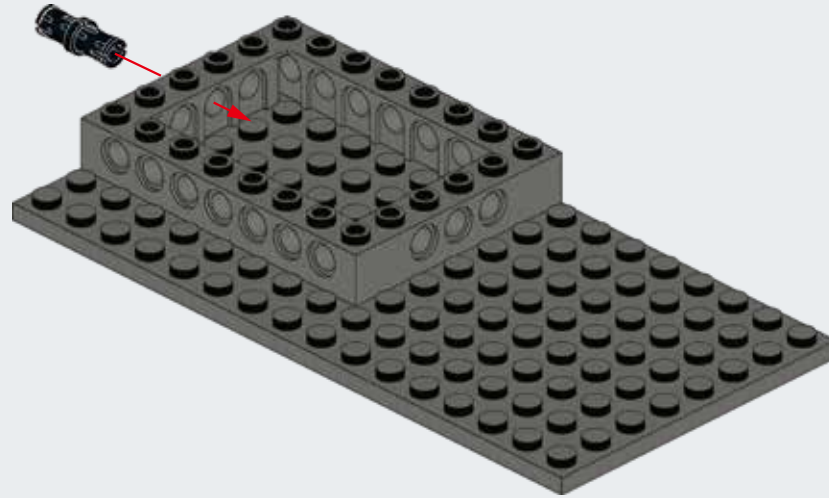

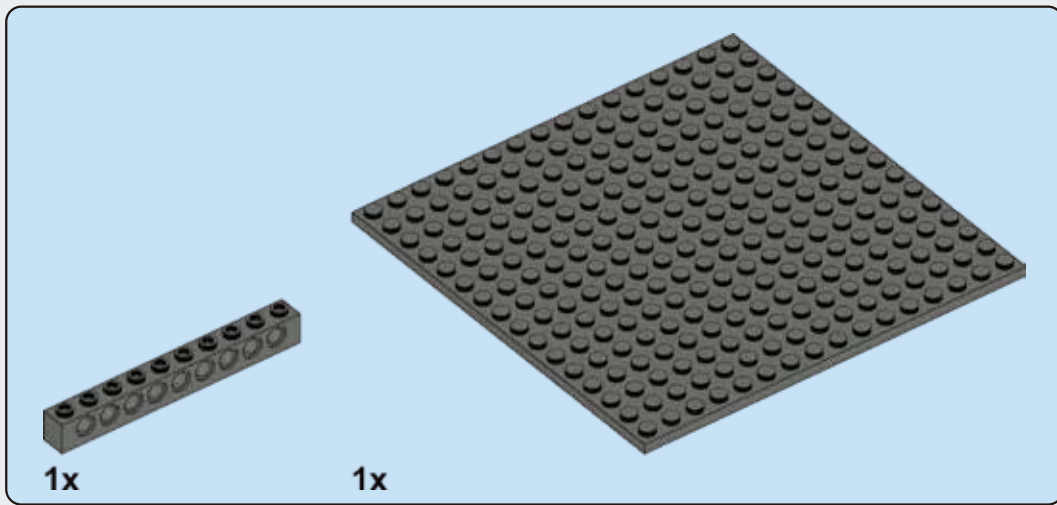

B2

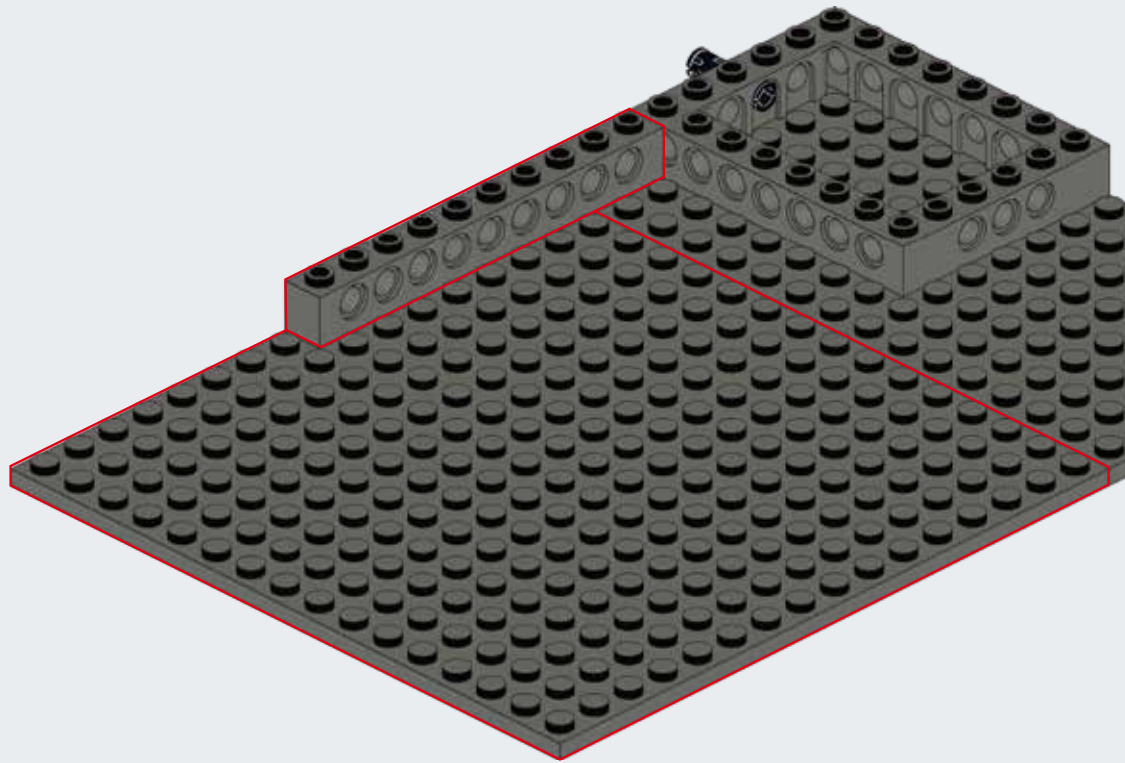

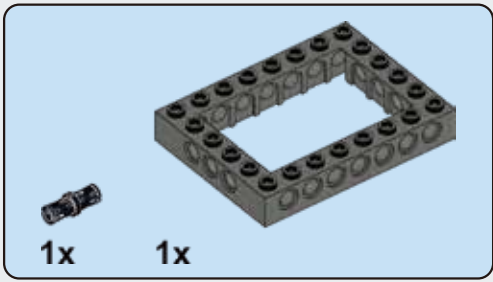

B3

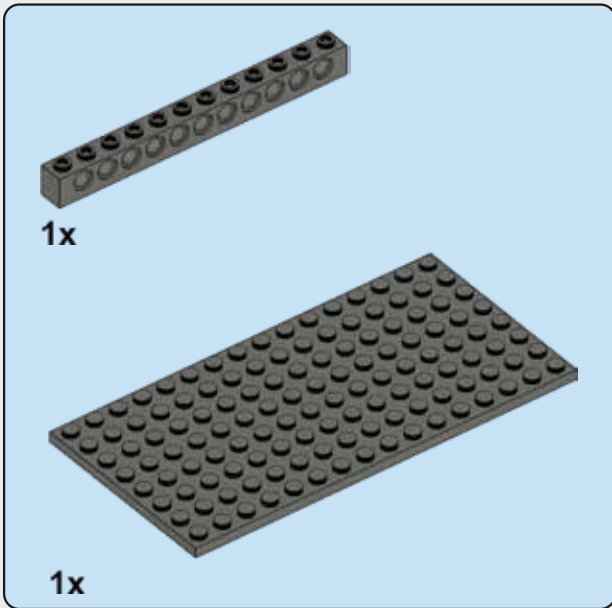
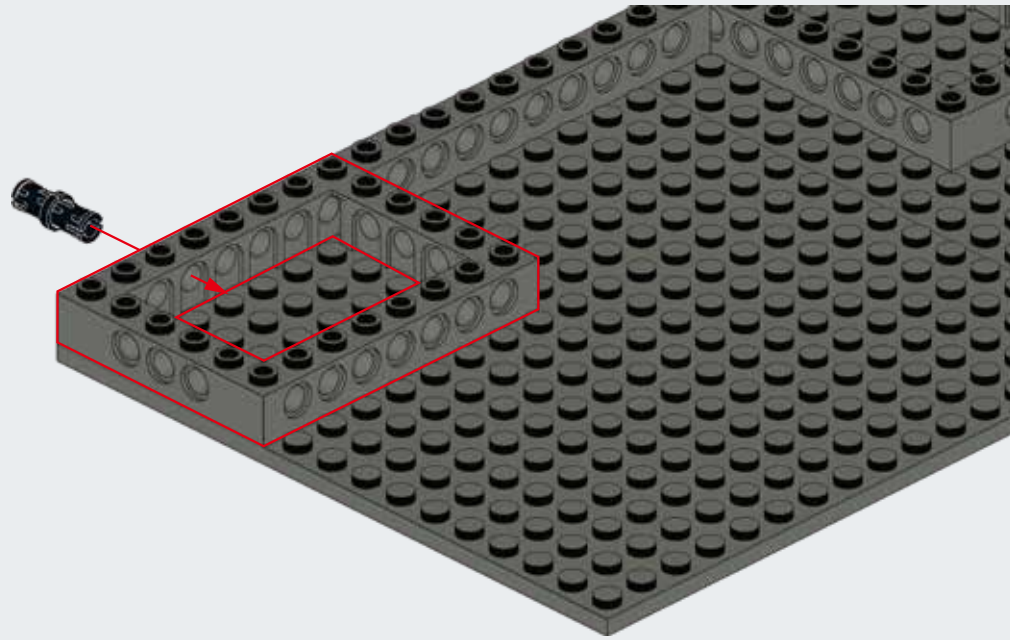

B4

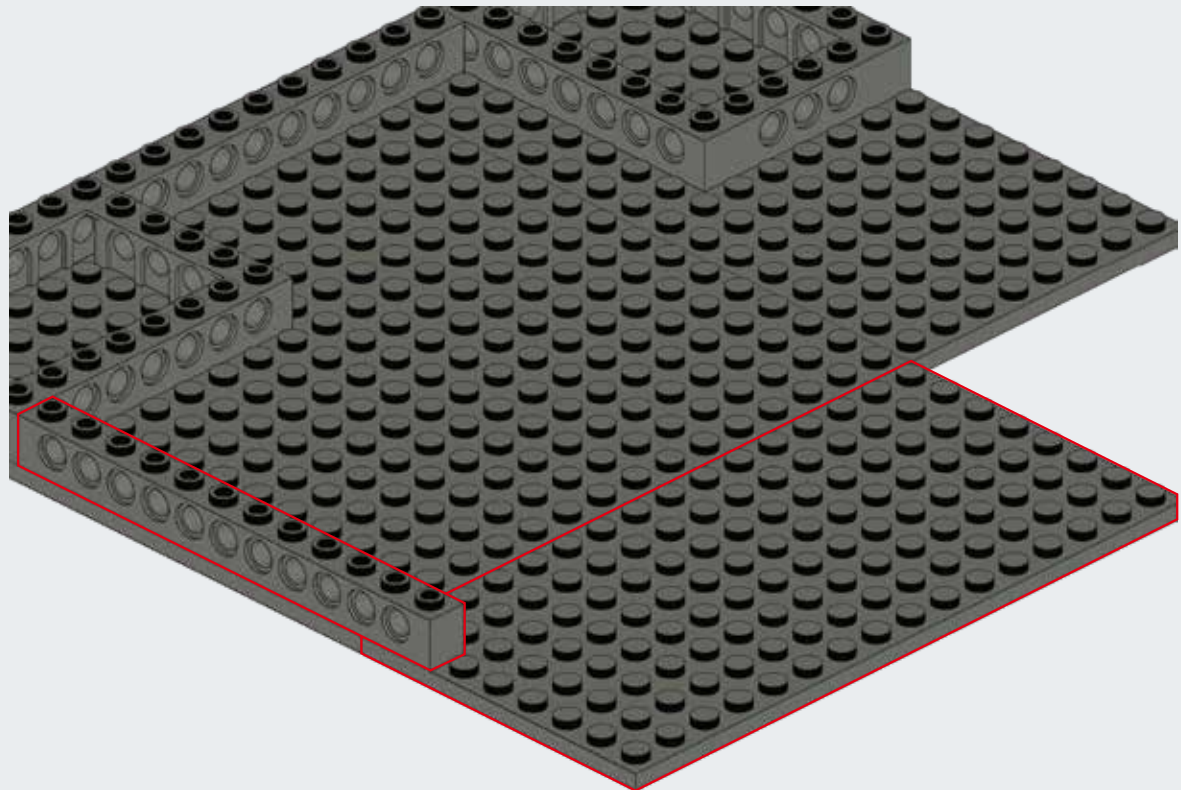

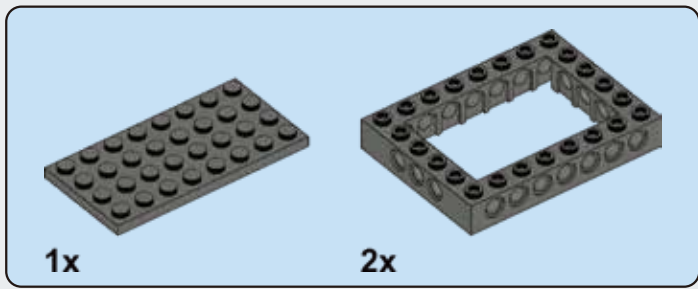

B5

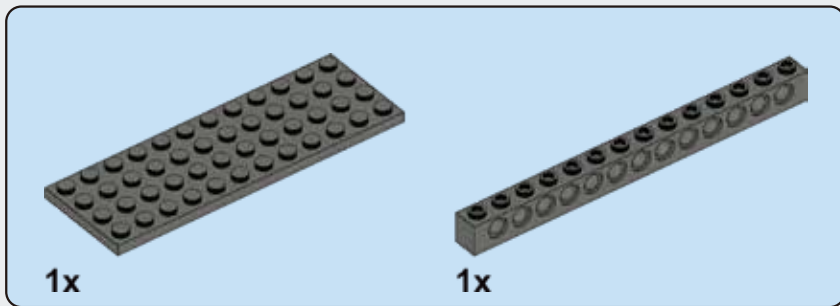
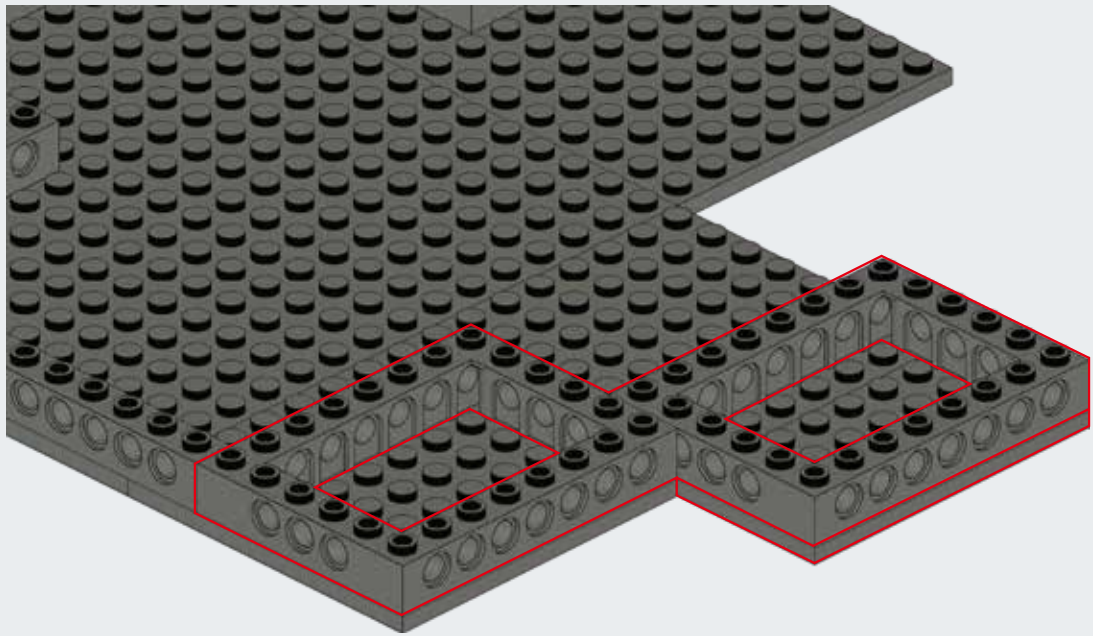

B6

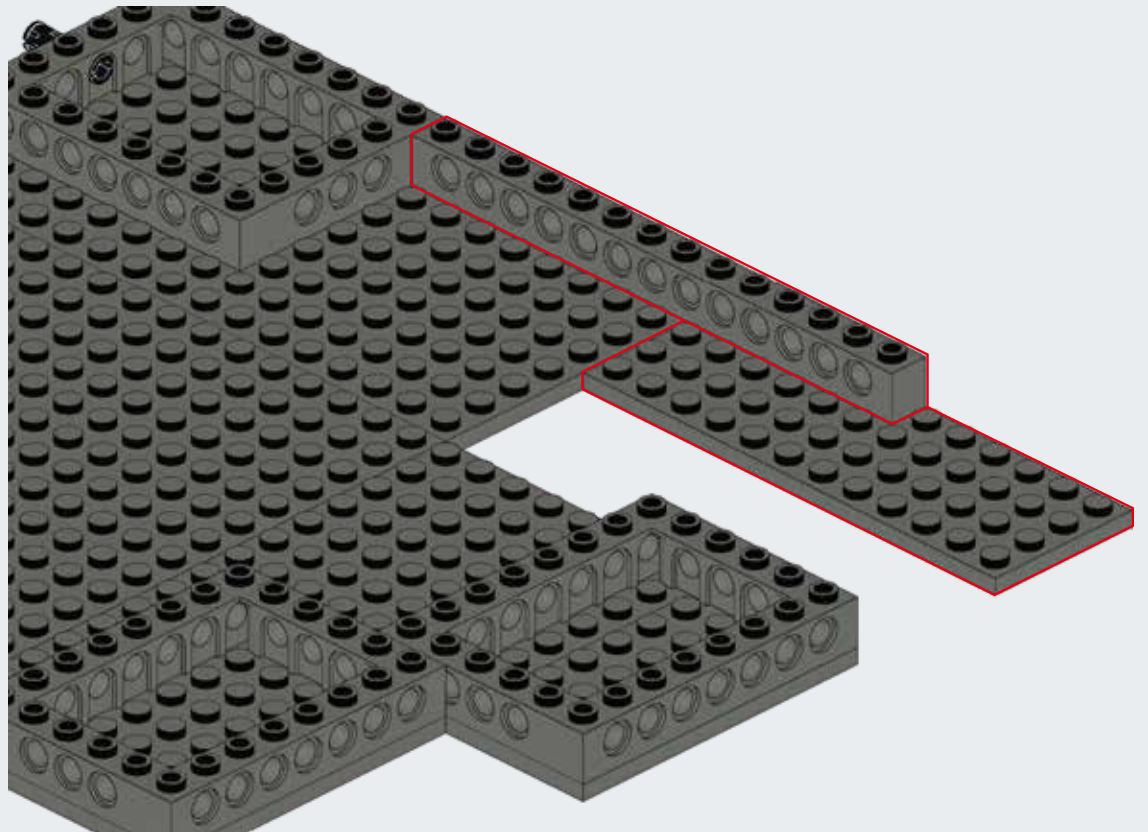

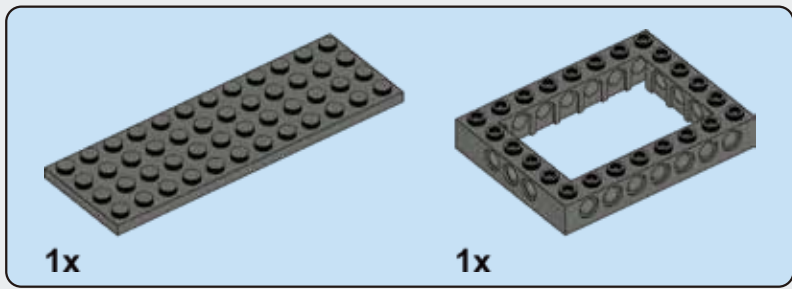

B7

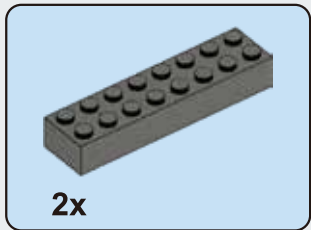
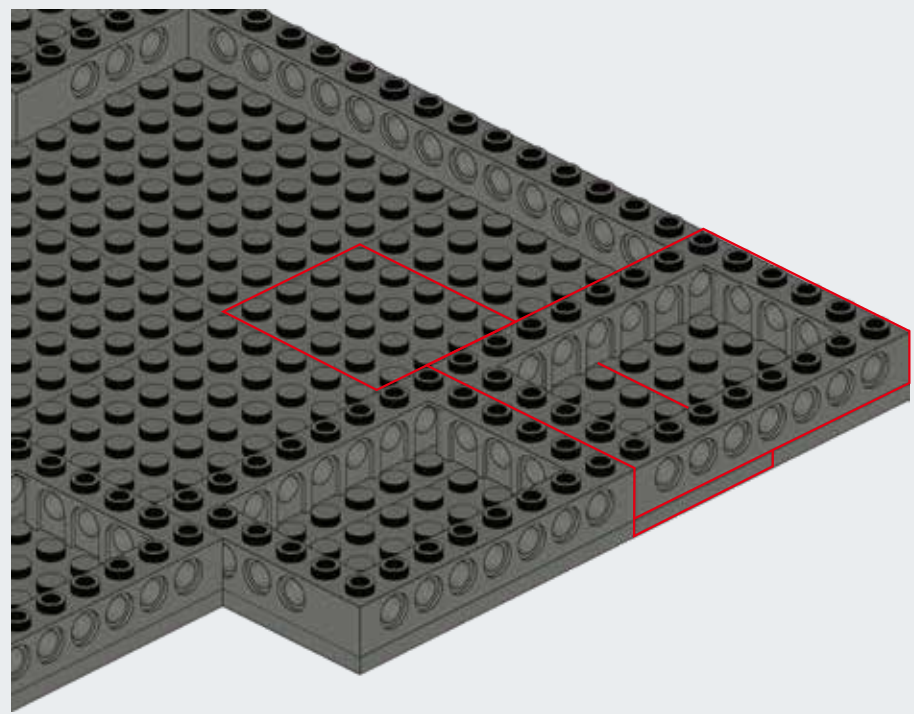

B8

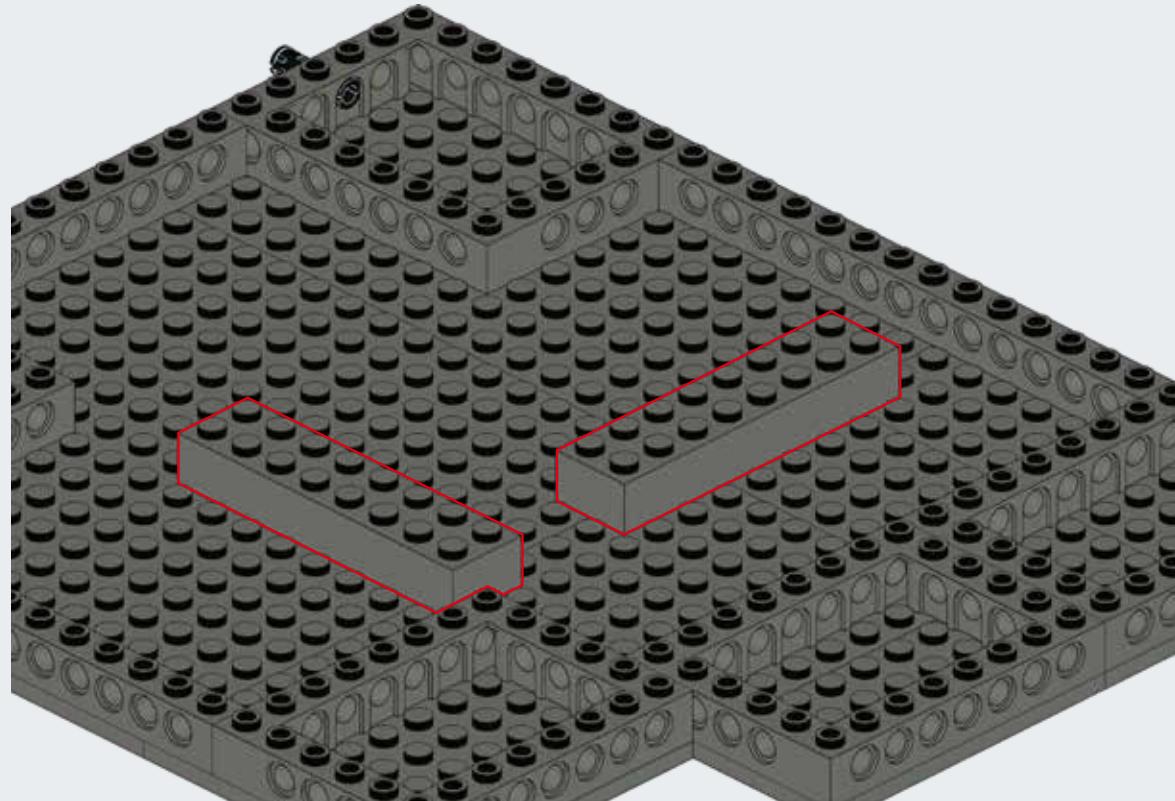

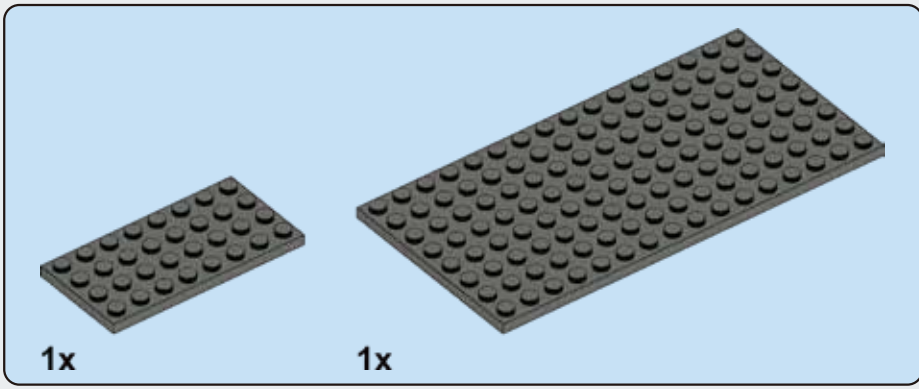

B9

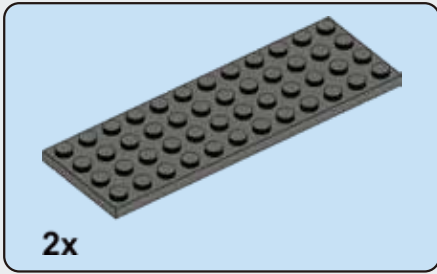
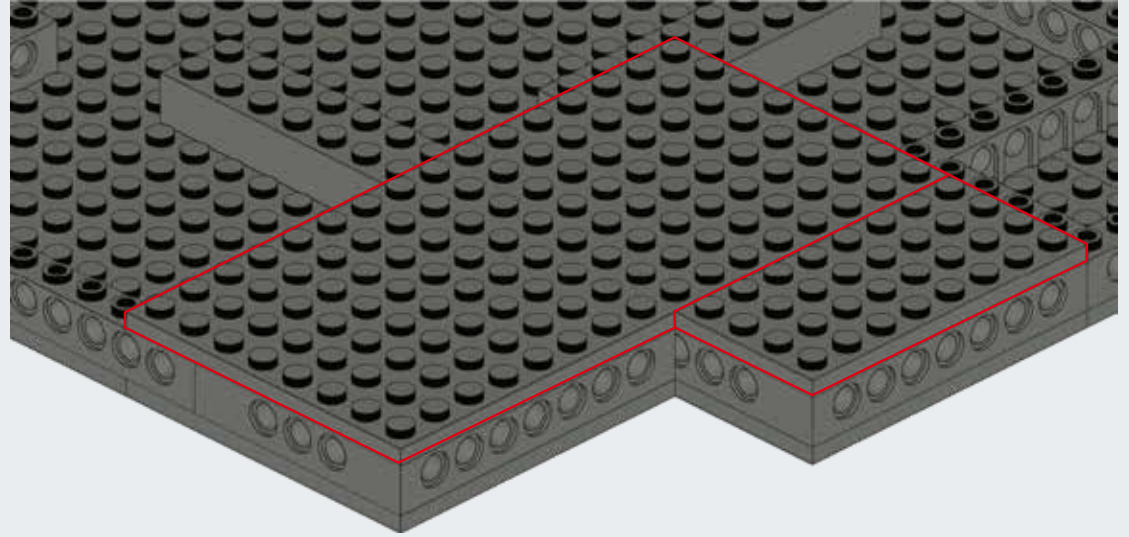

B10

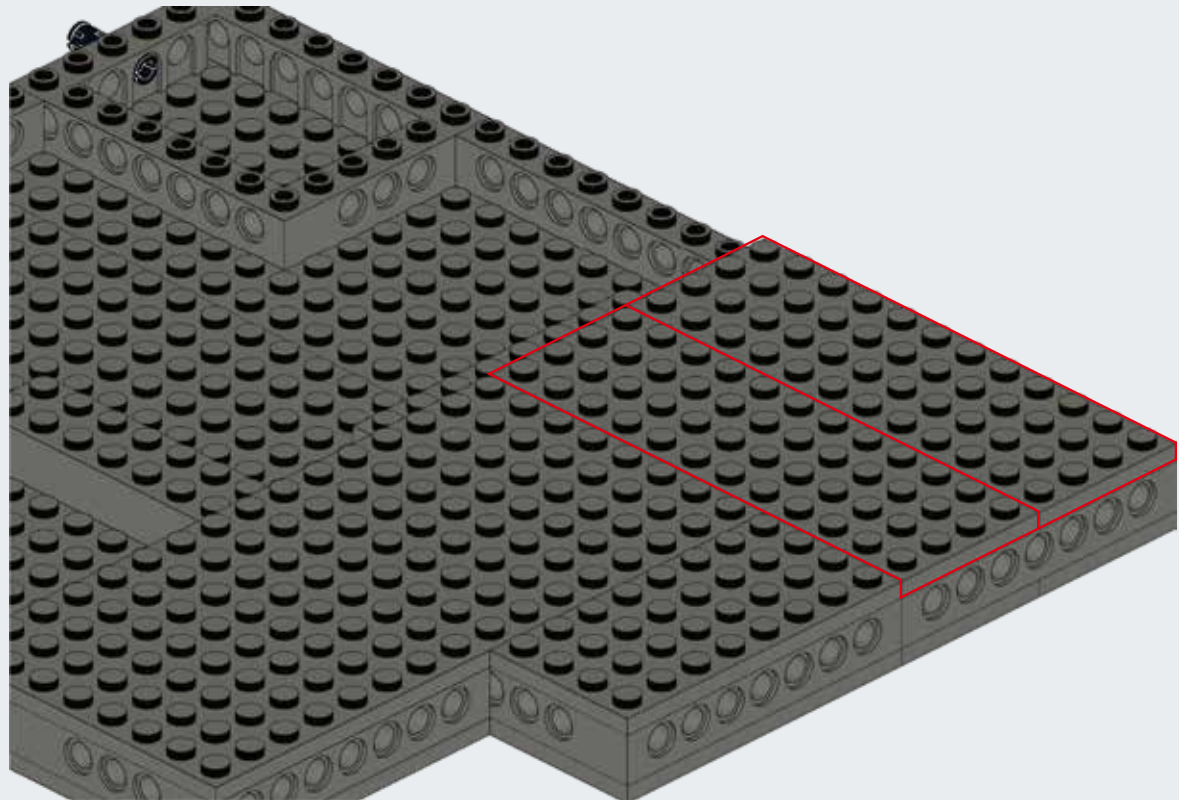

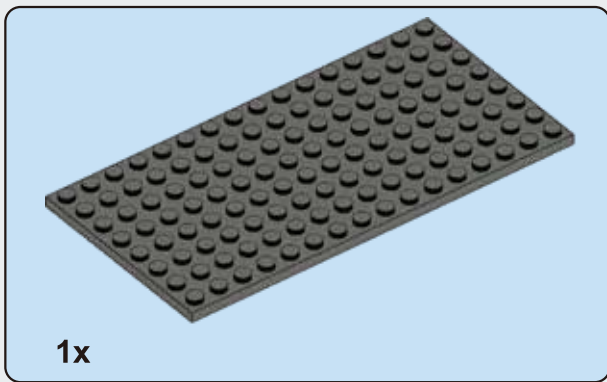

B11

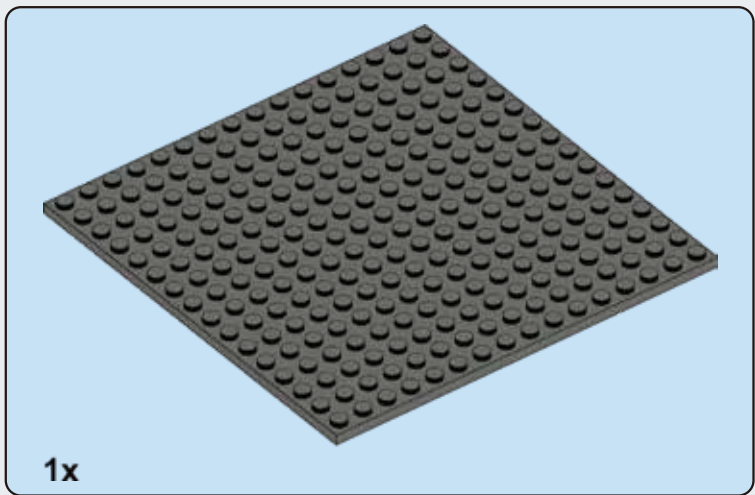
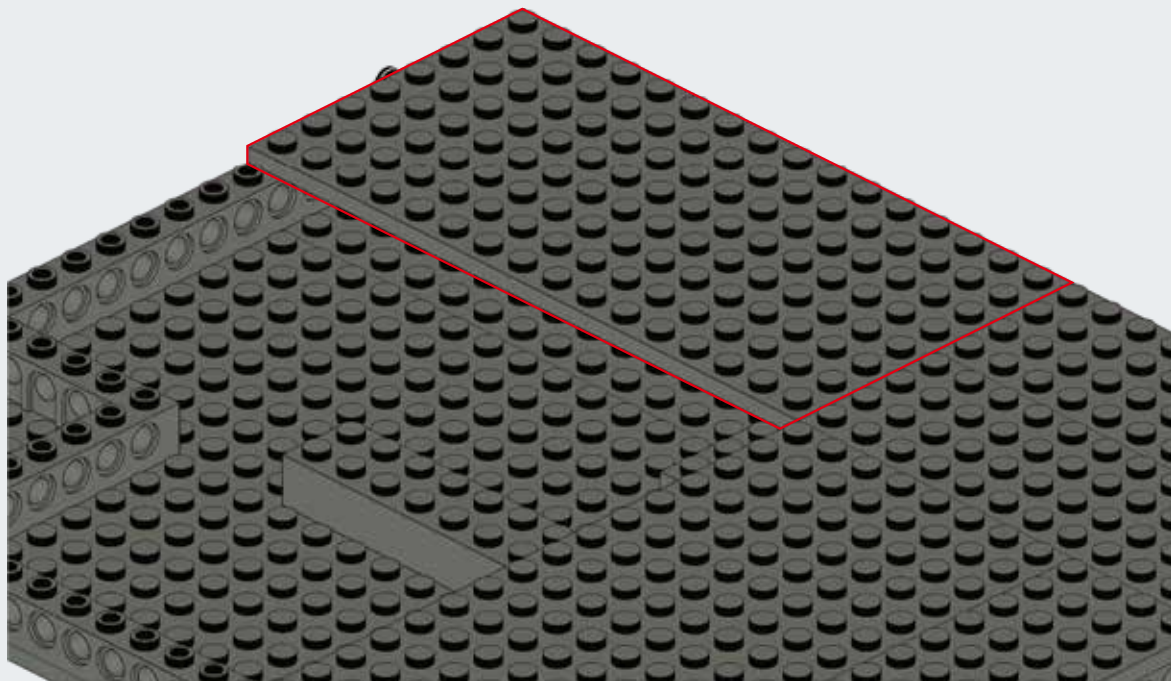

B12

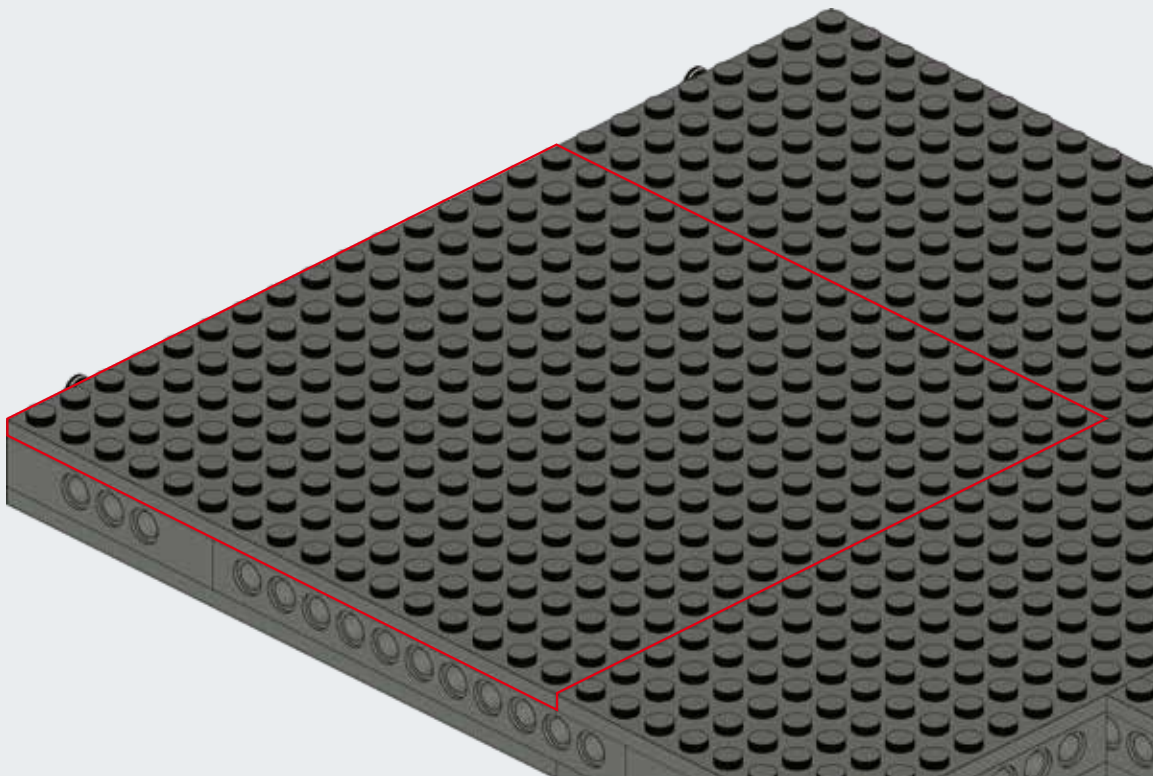

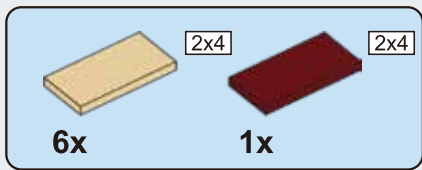

B13

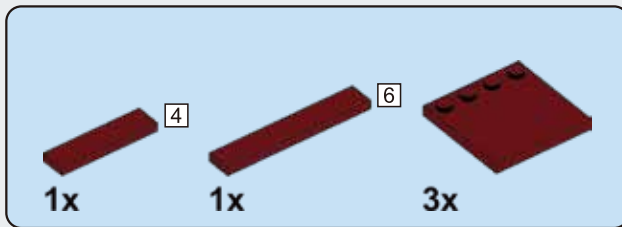
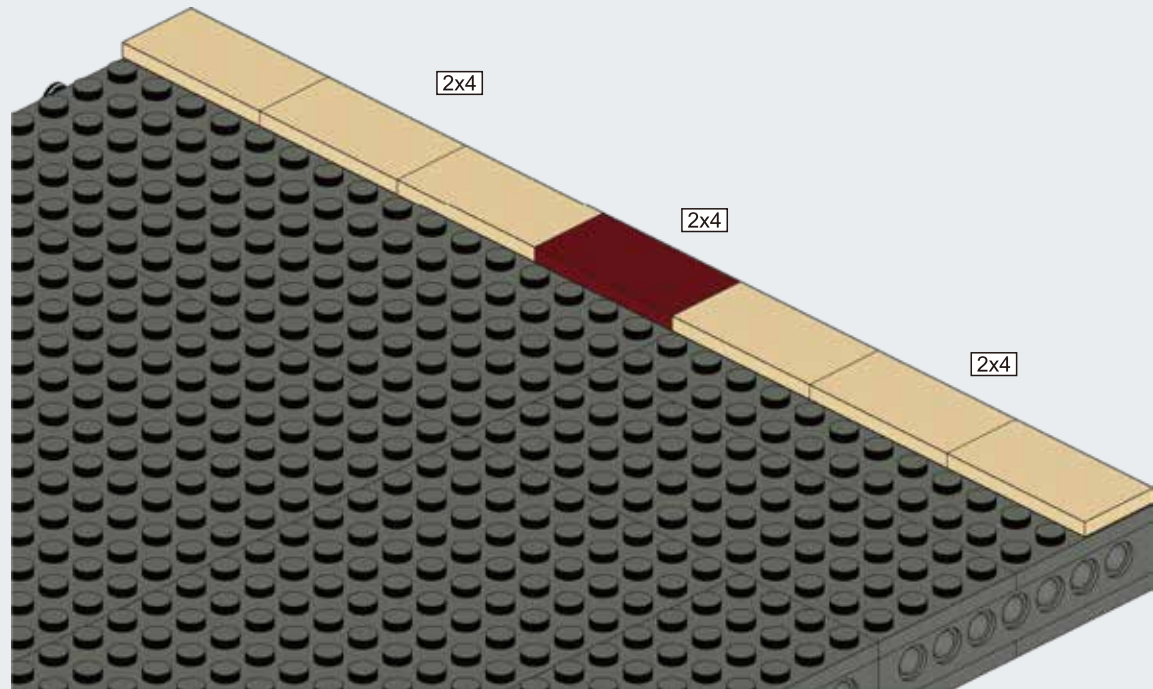

B14

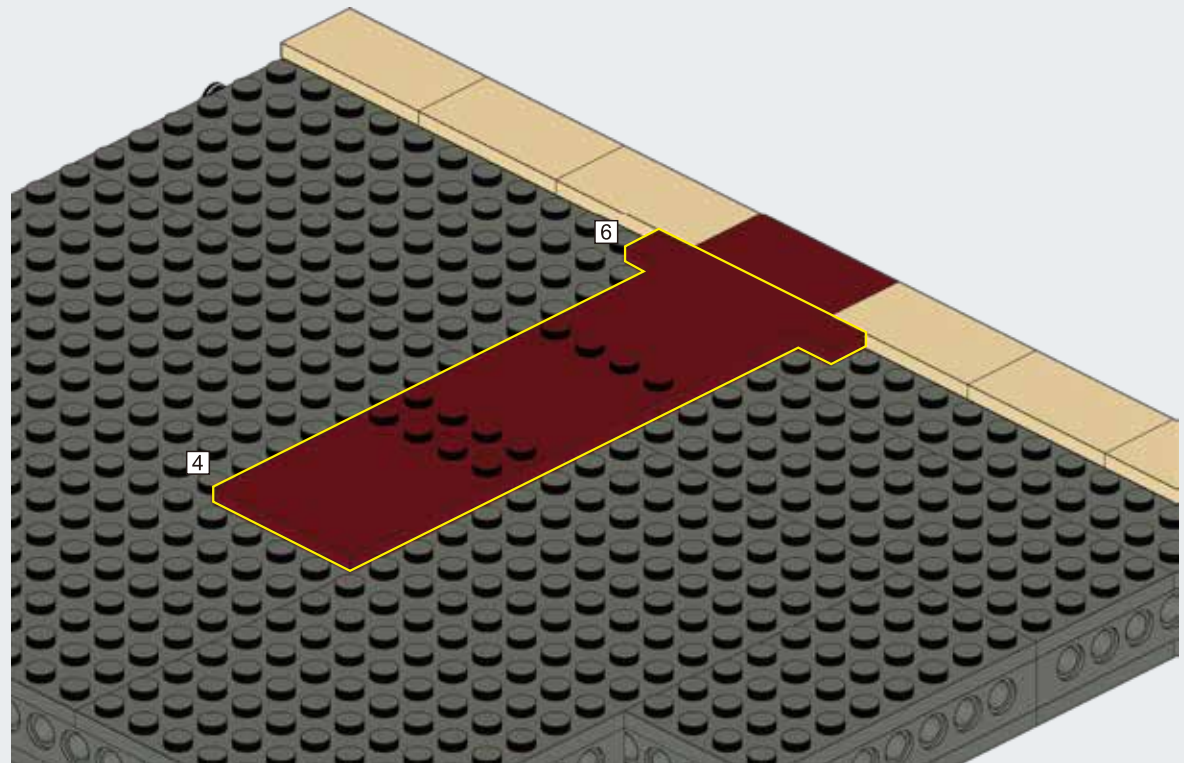

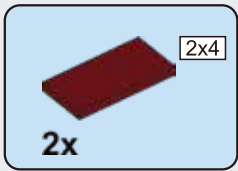

B15

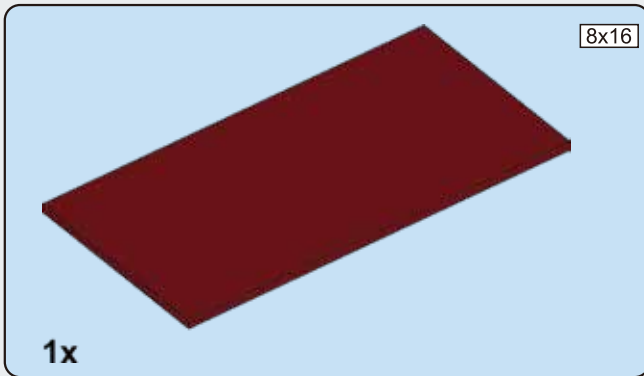
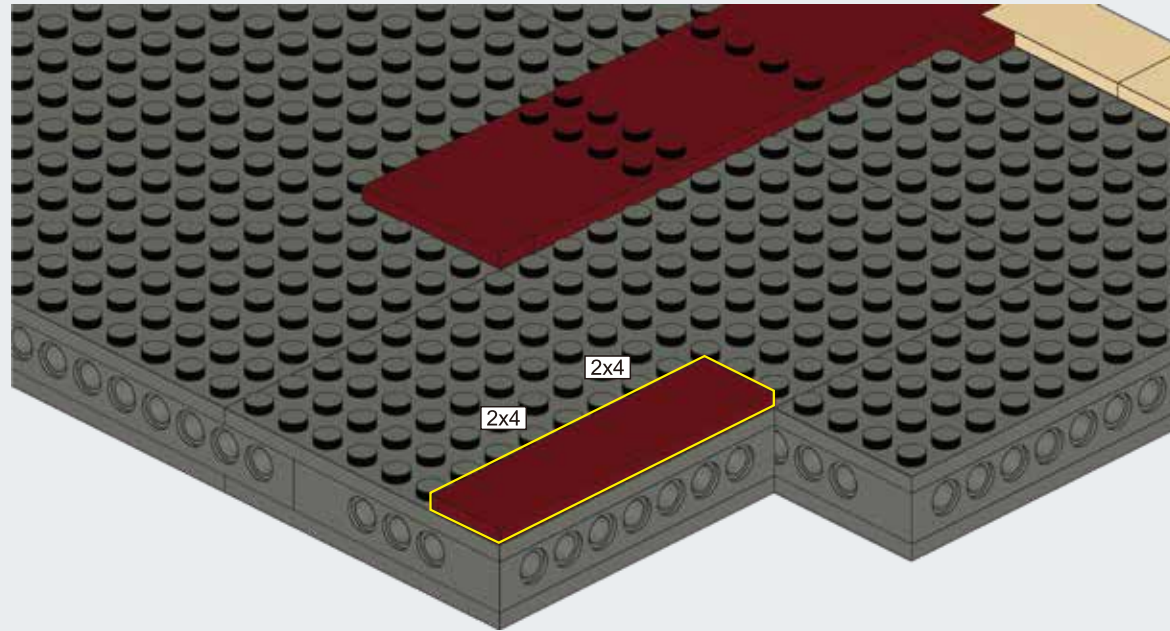

B16

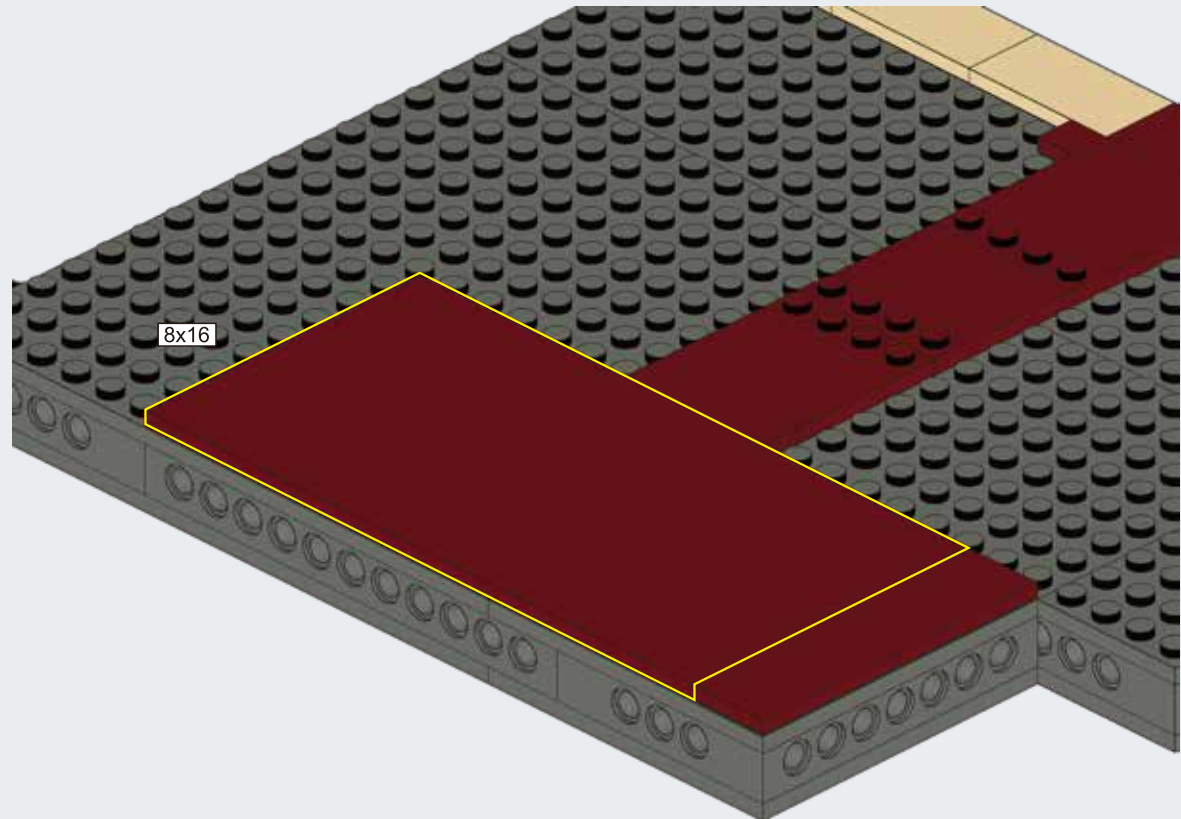

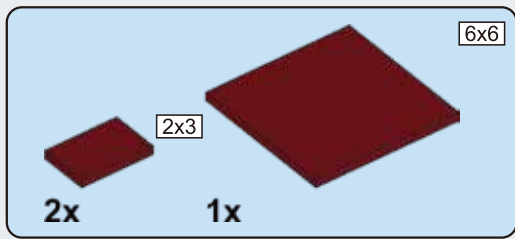

B17

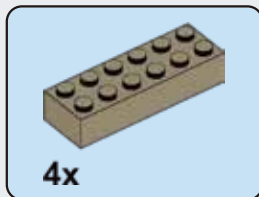
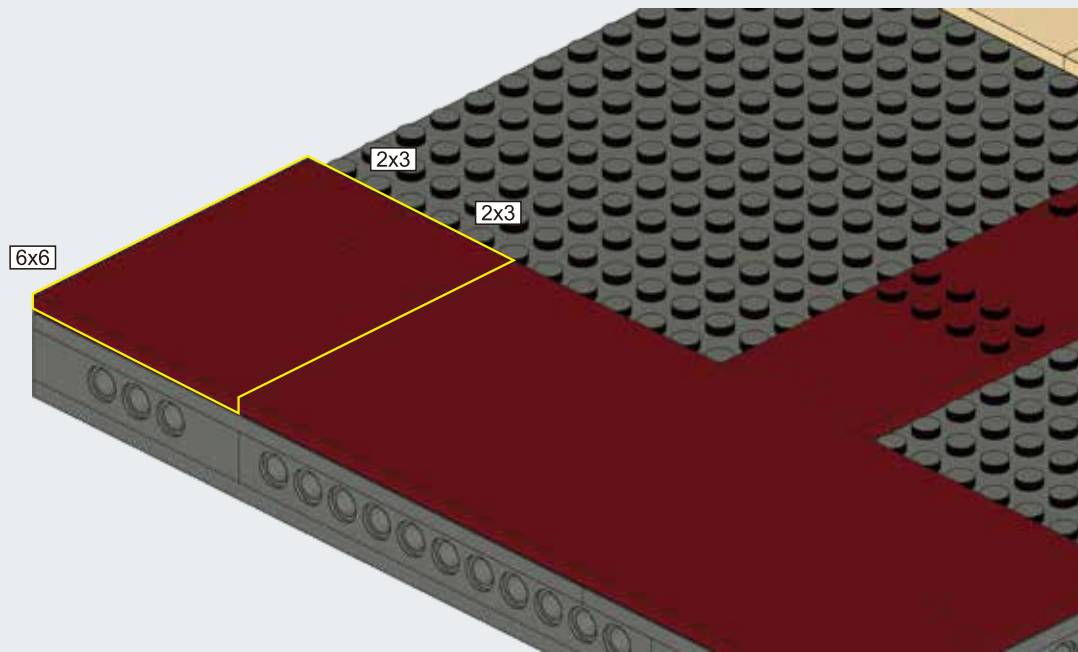

B18

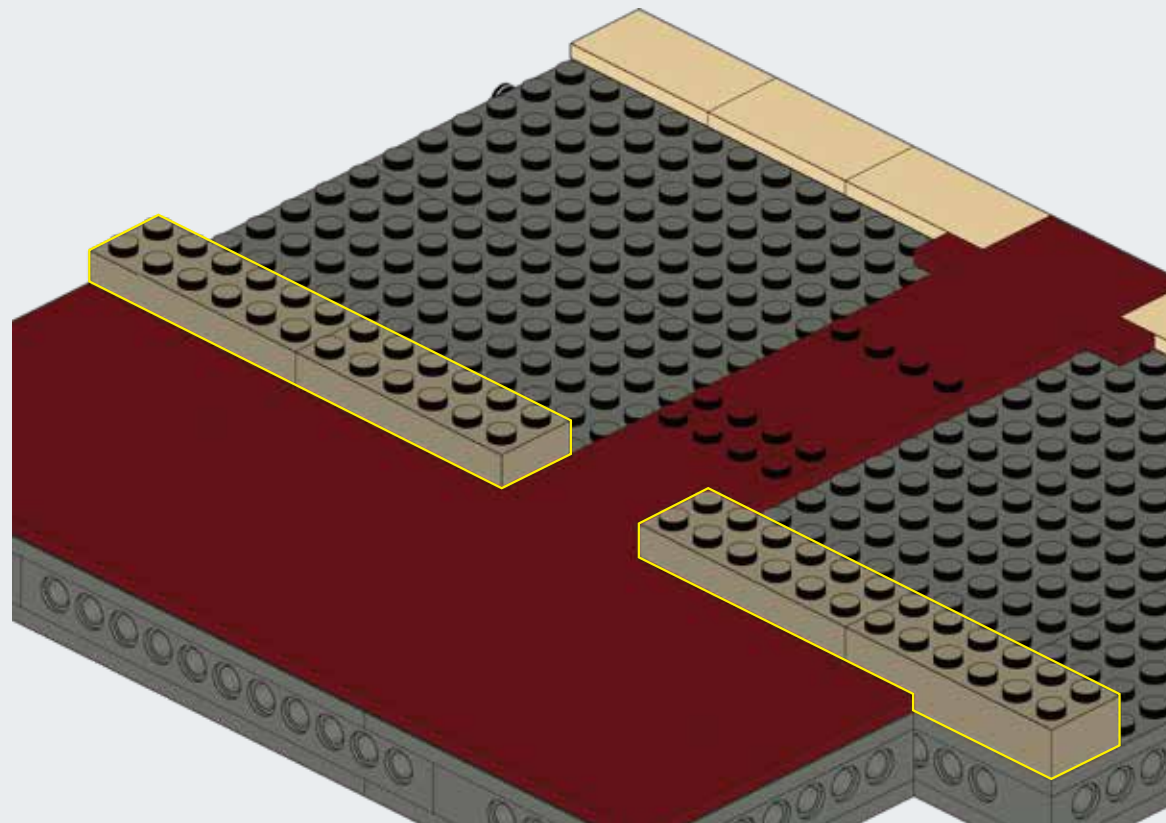

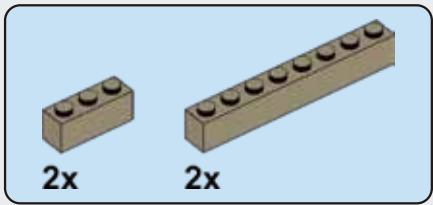

B19

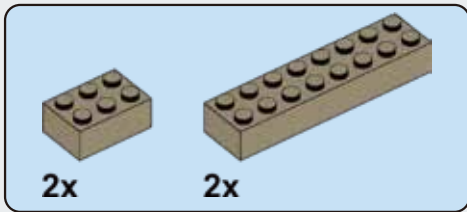
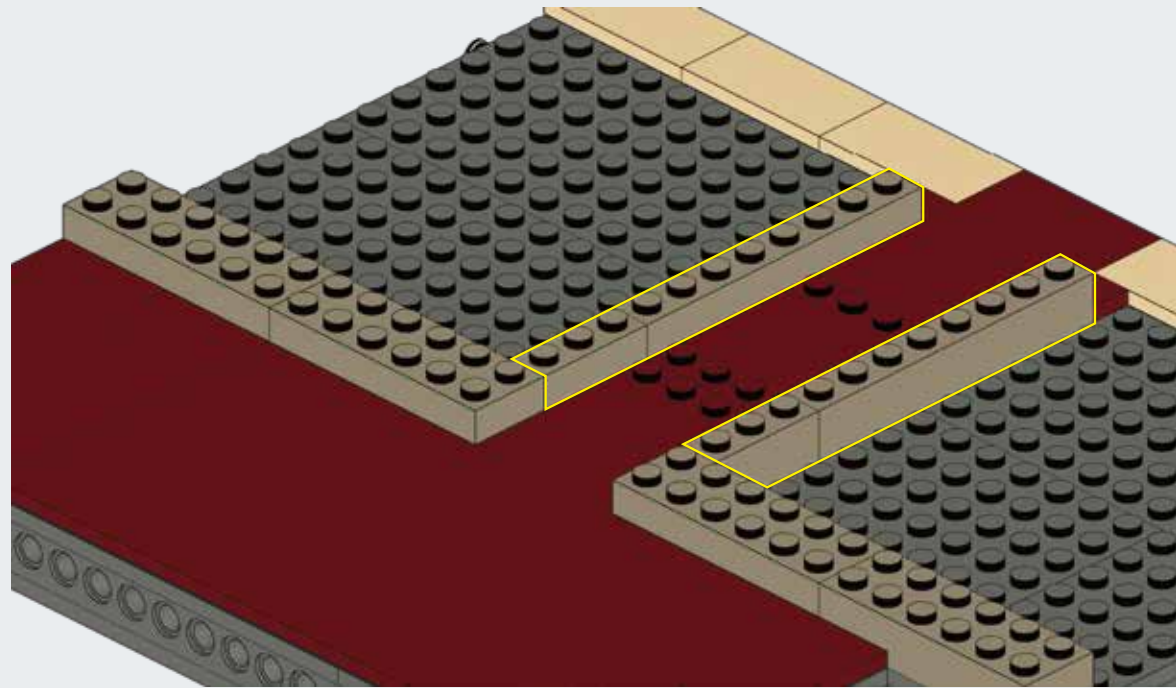

B20

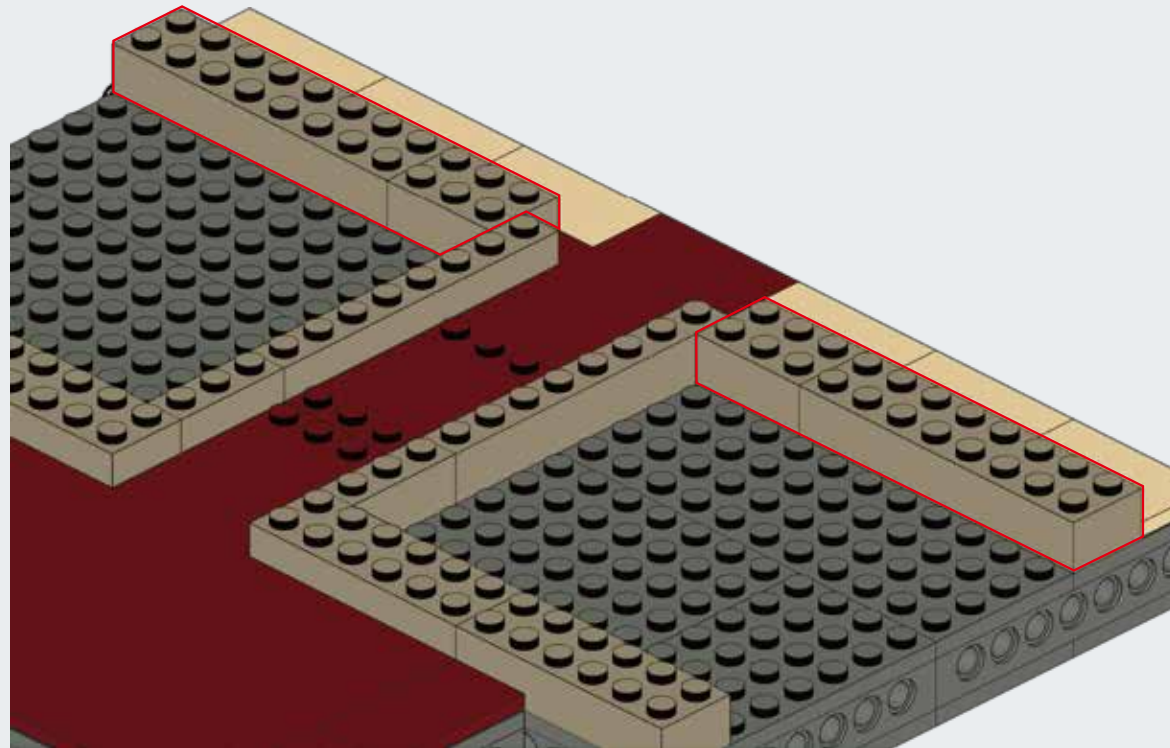

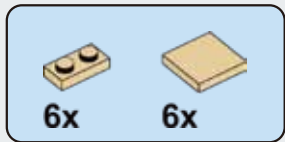

B21

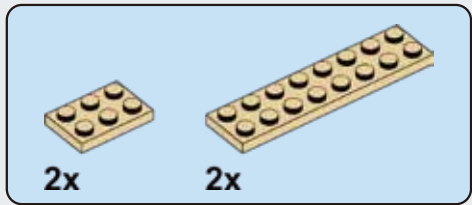
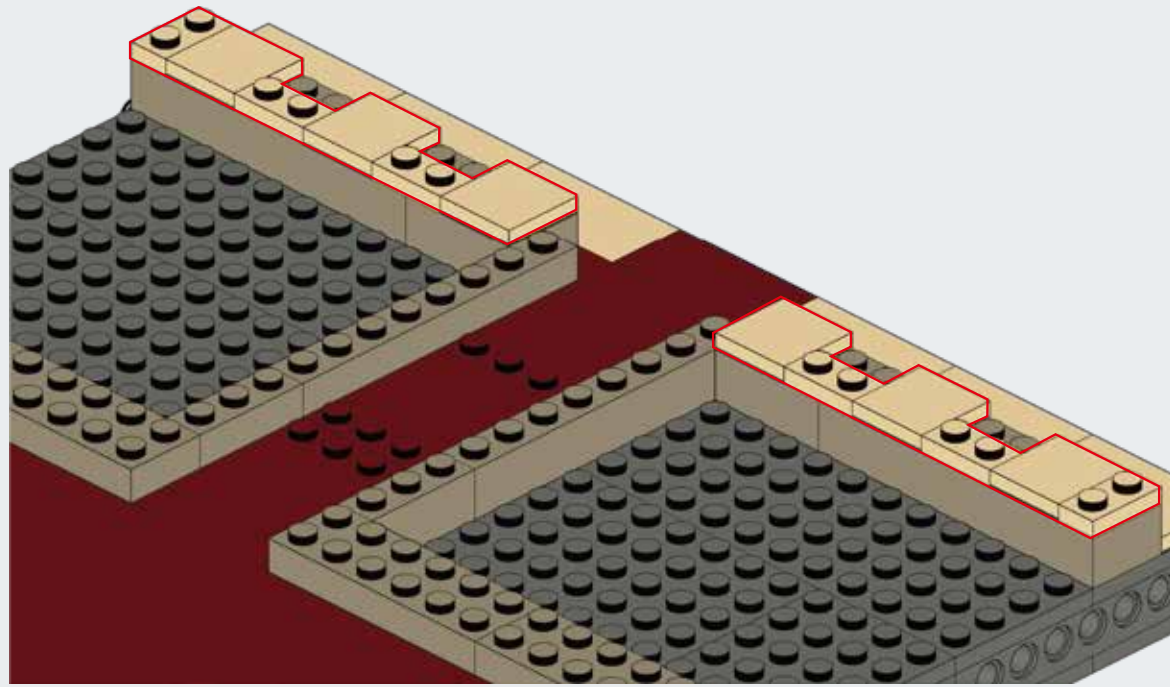

B22

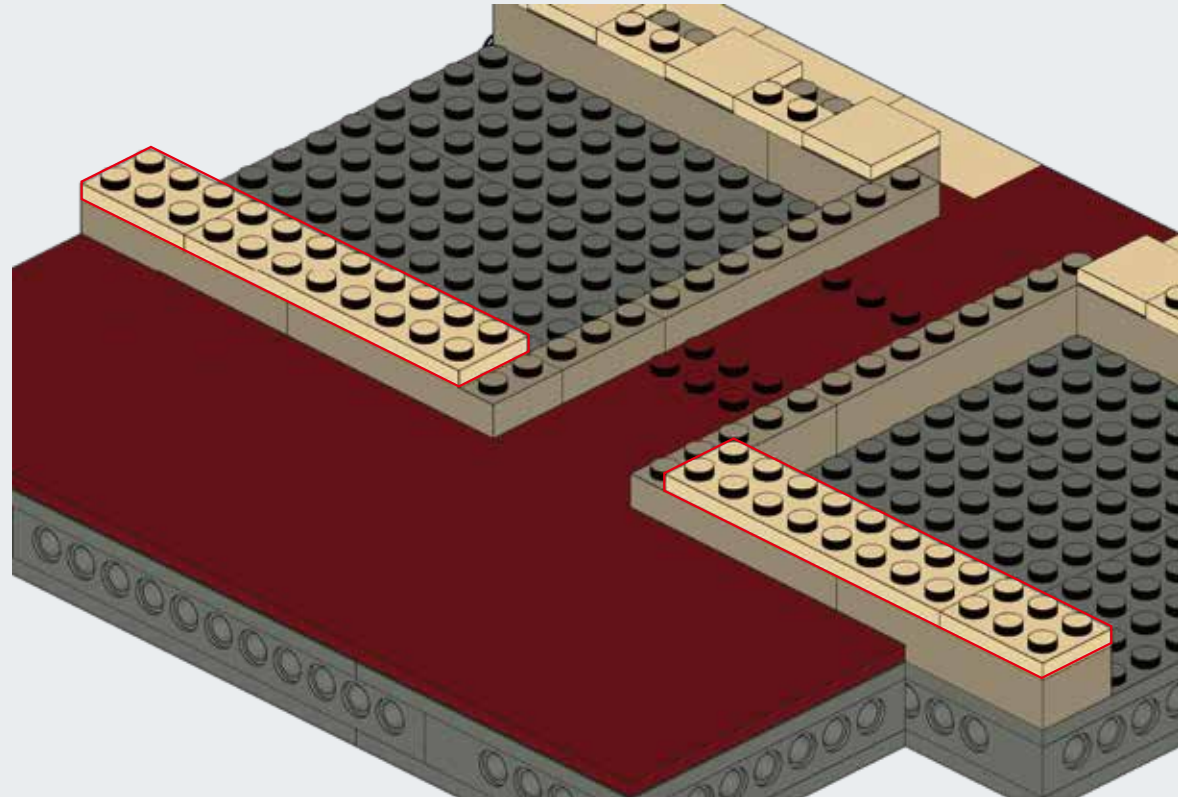

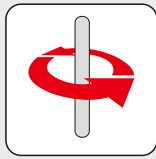
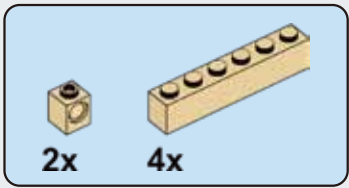

B23

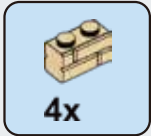
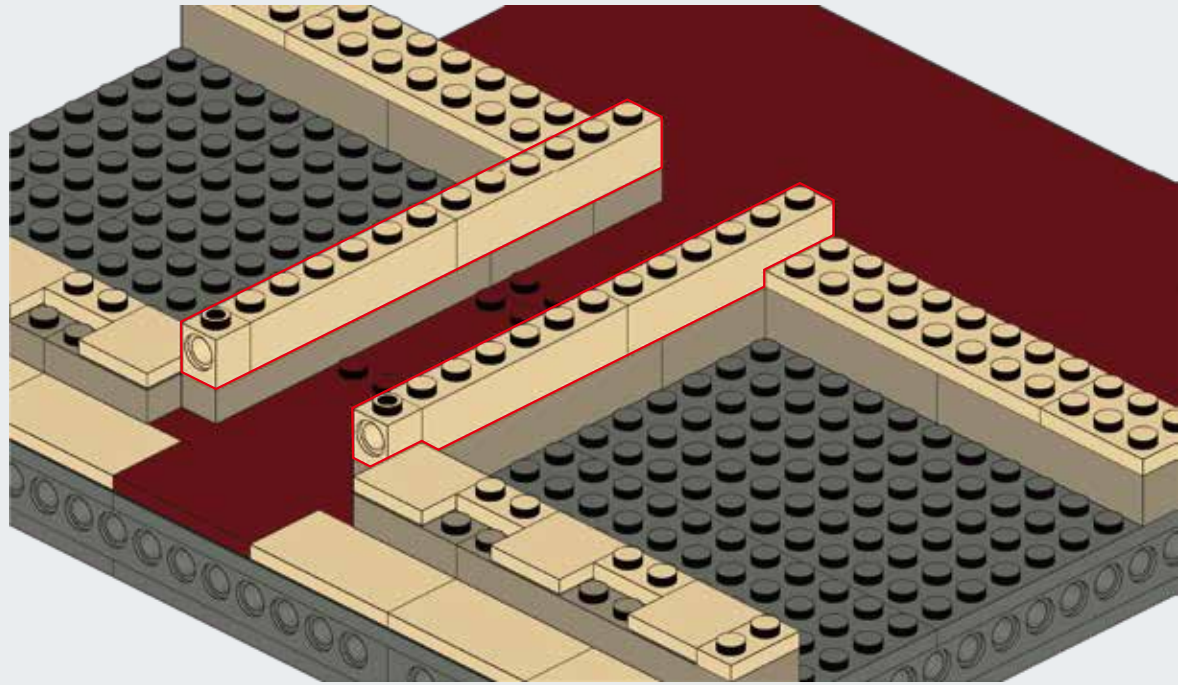

B24

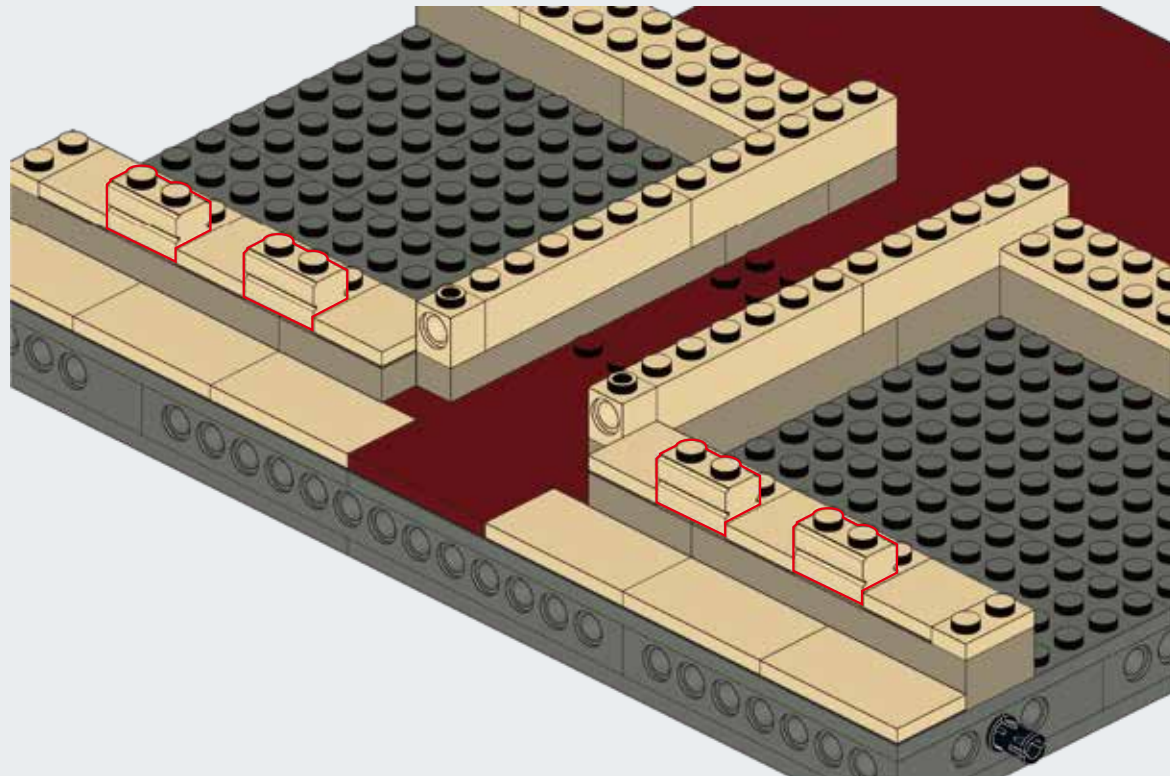

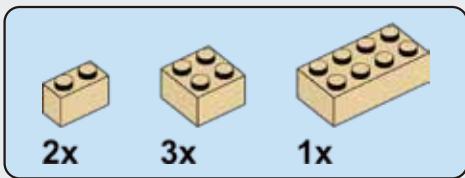

B25

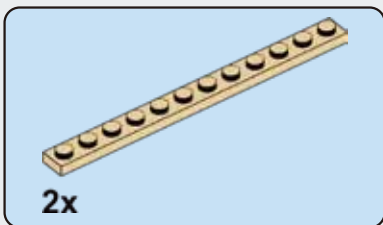
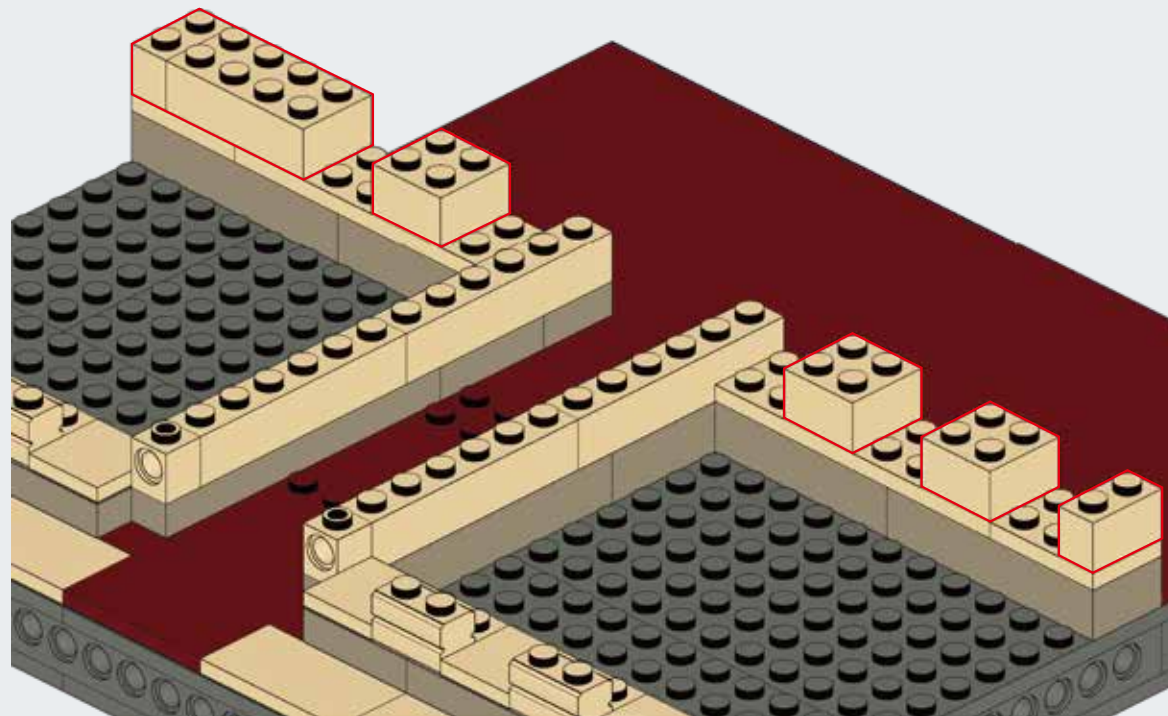

B26

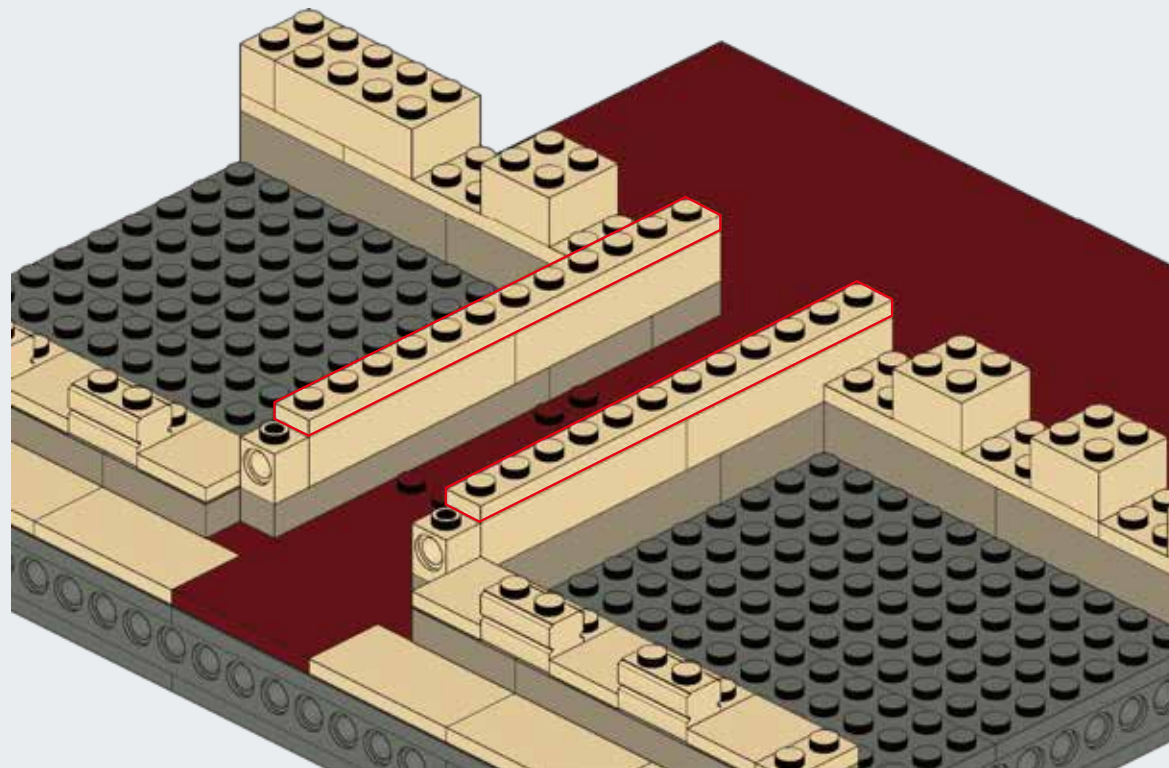

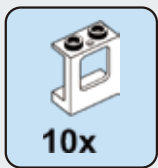

B27

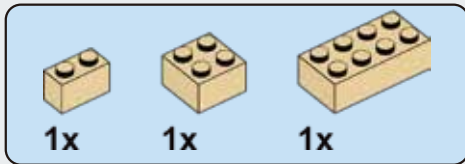
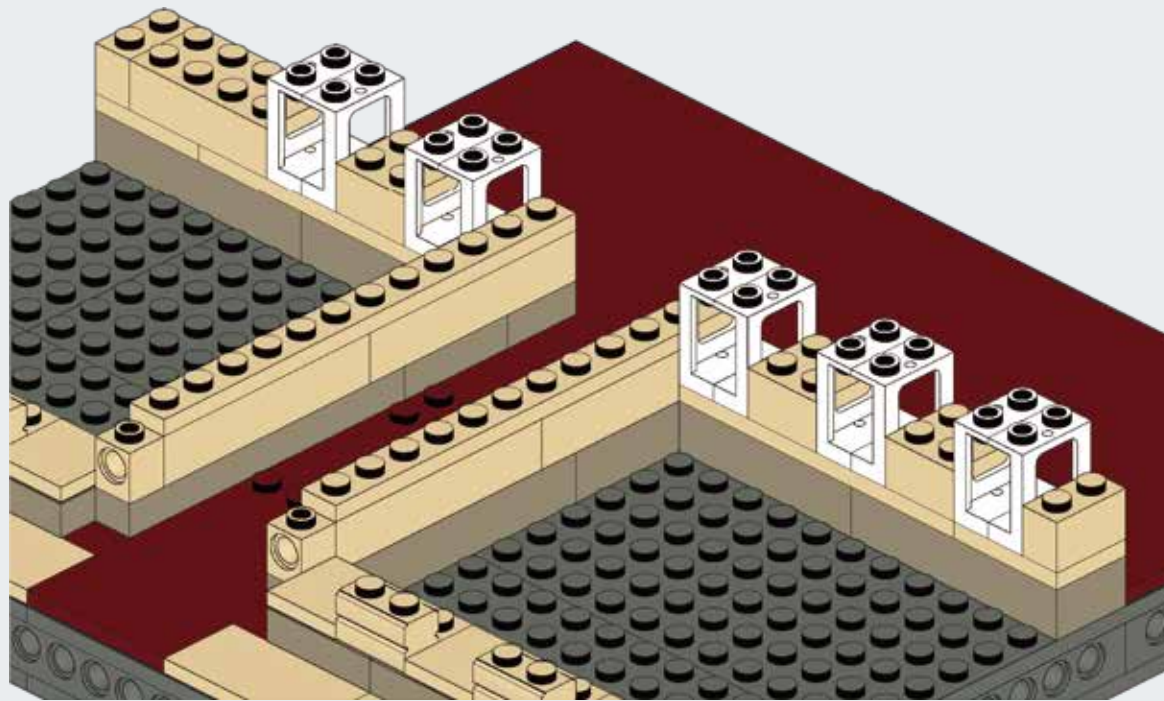

B28

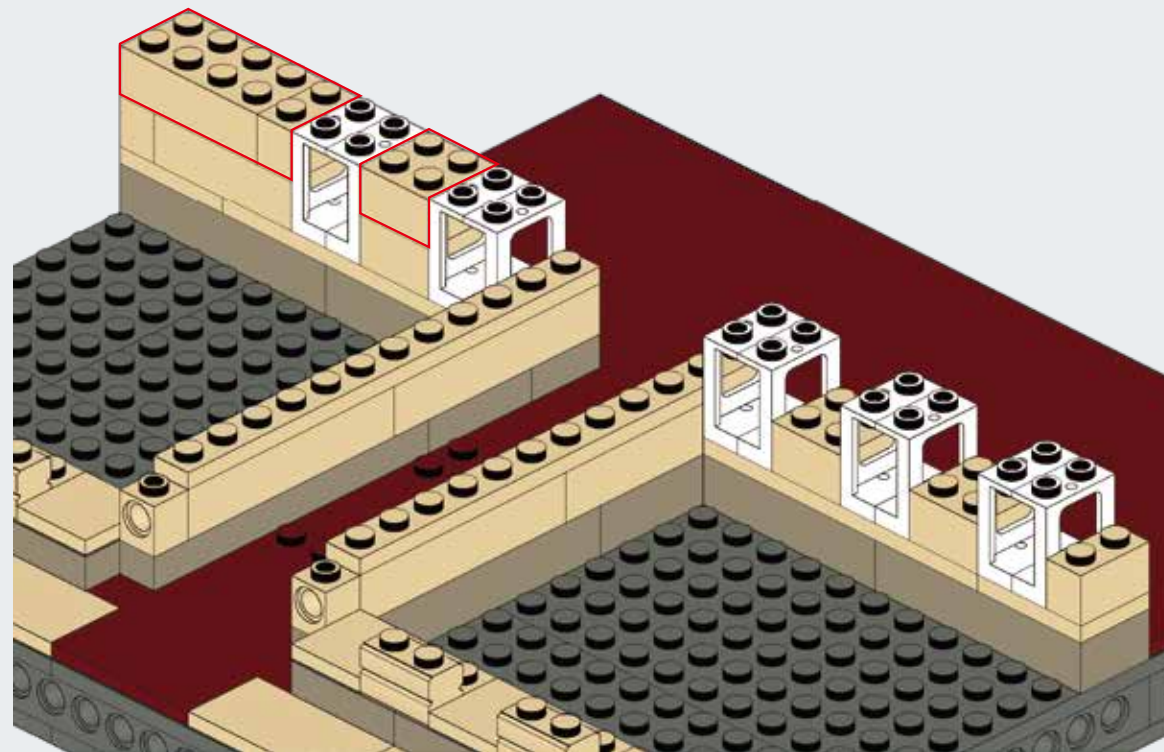

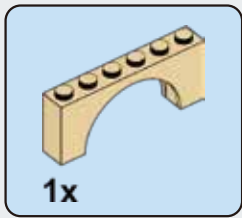

B29

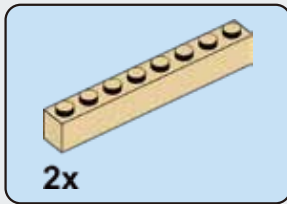
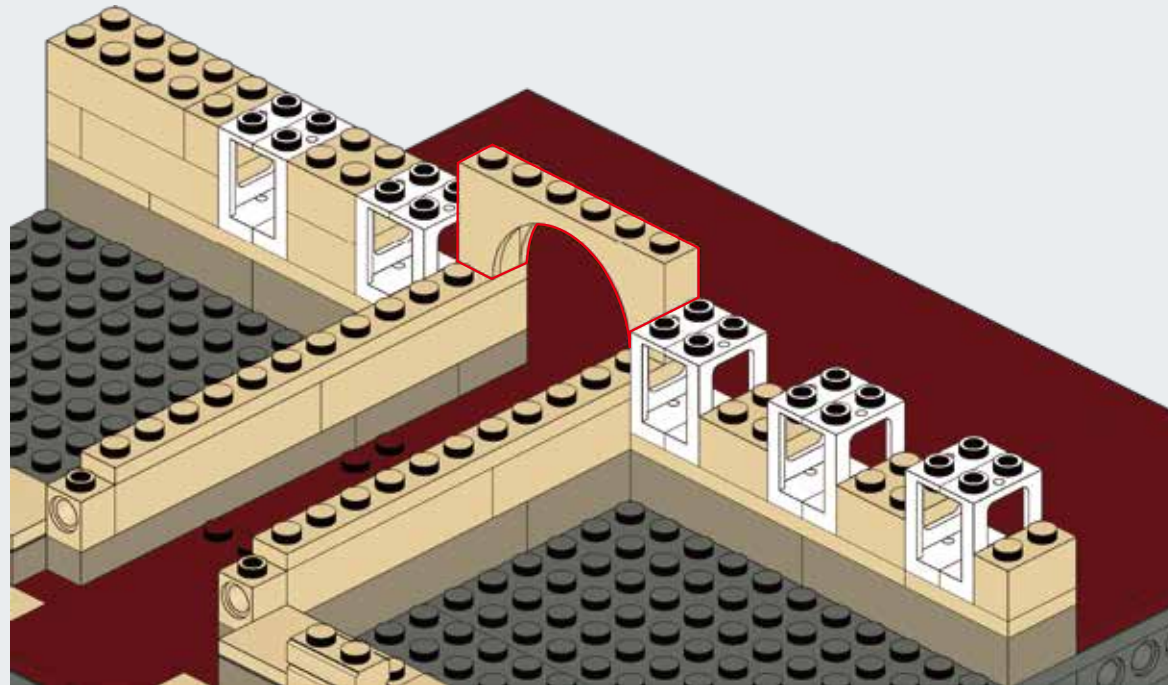

B30

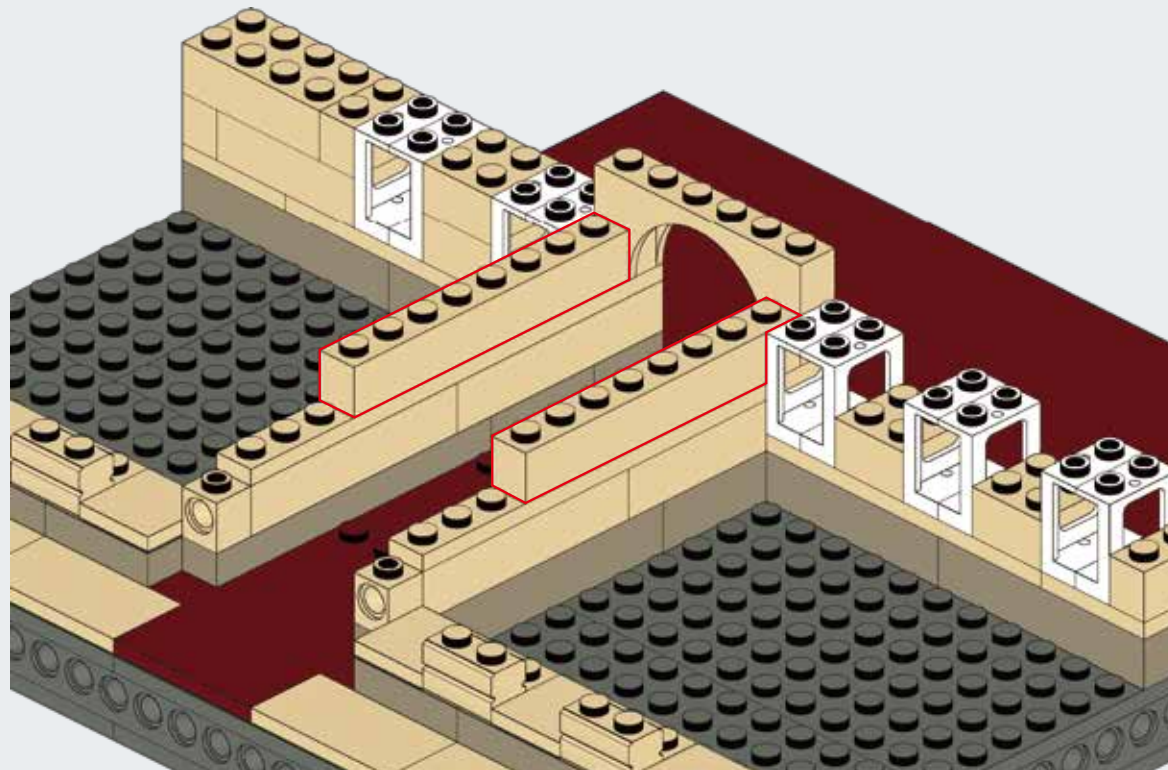

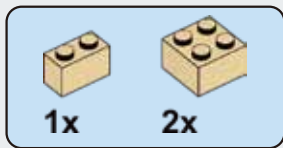

B31

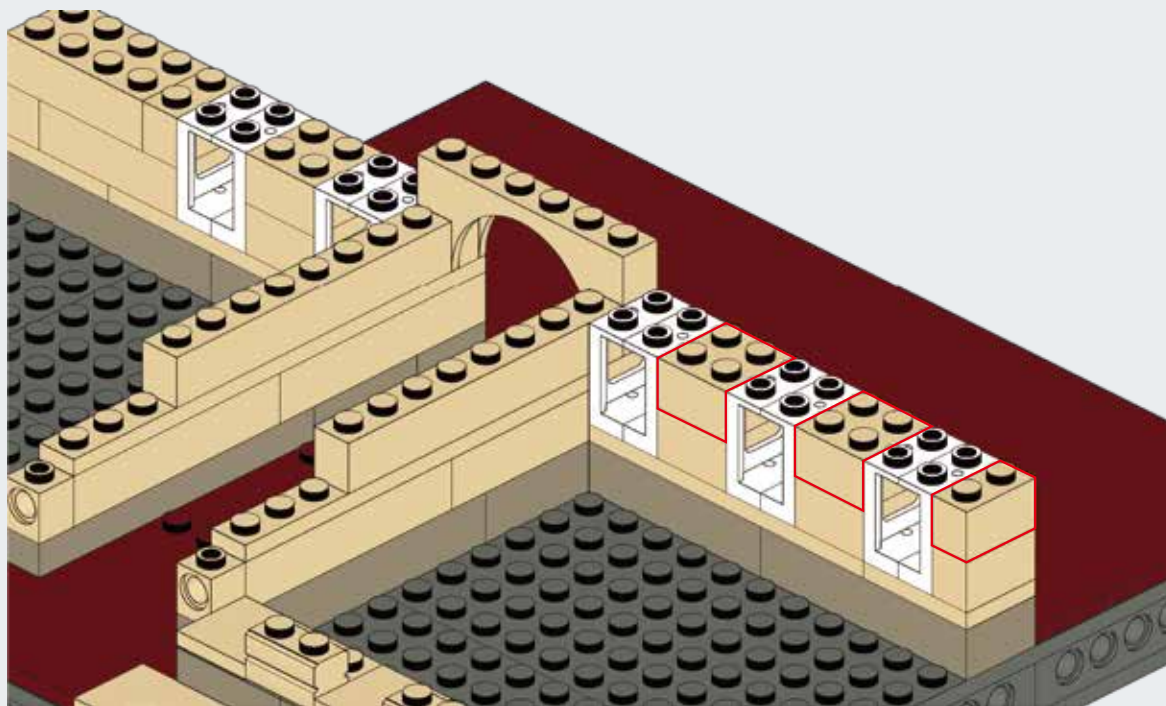

B32

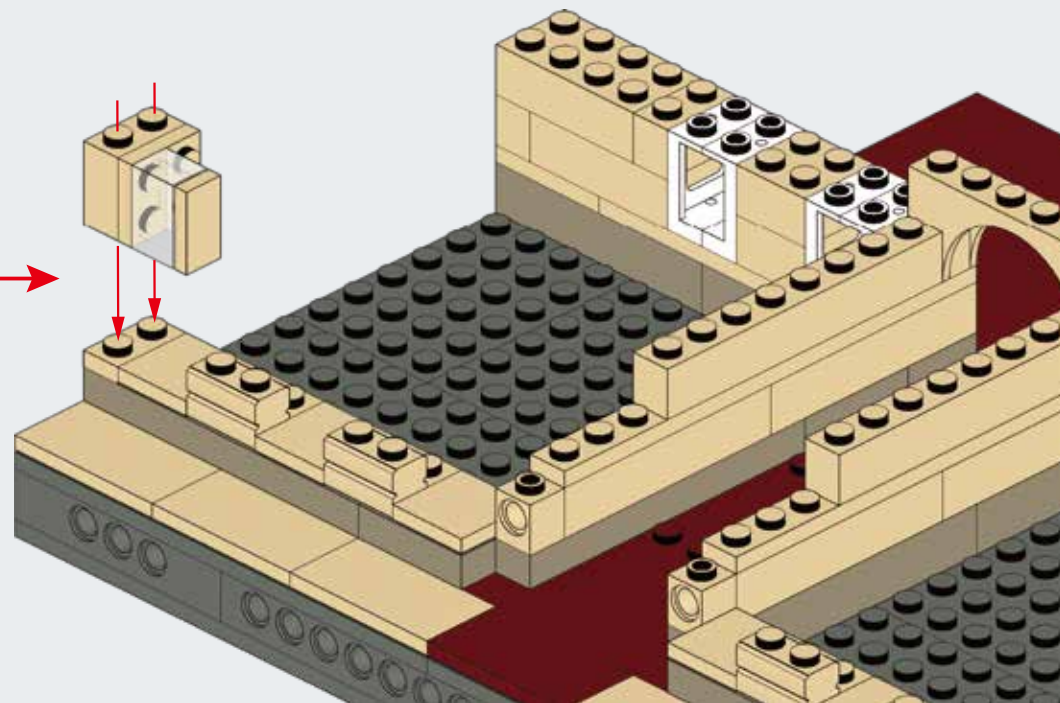
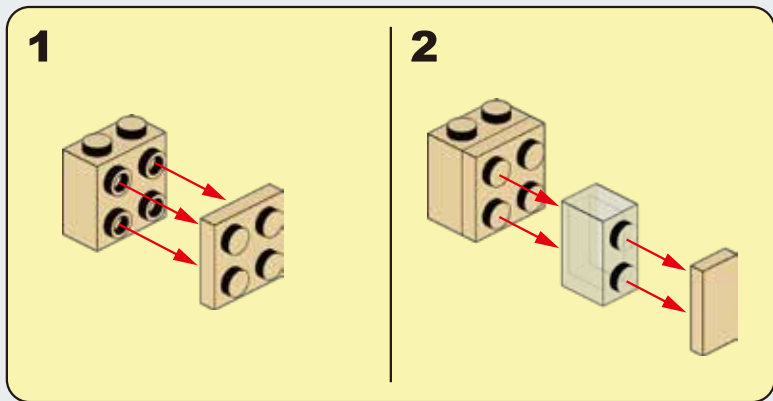

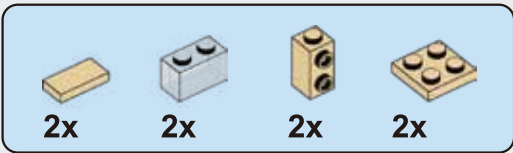

B33

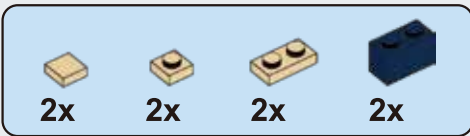
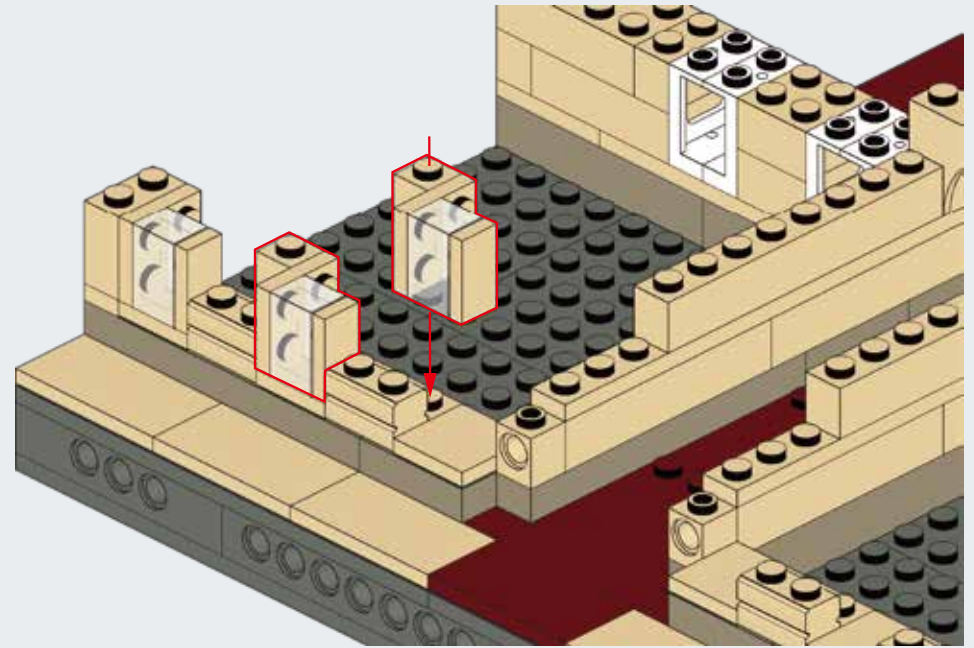
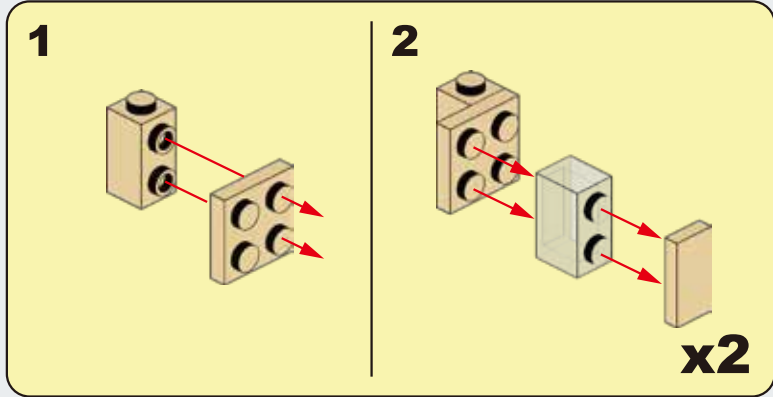

B34

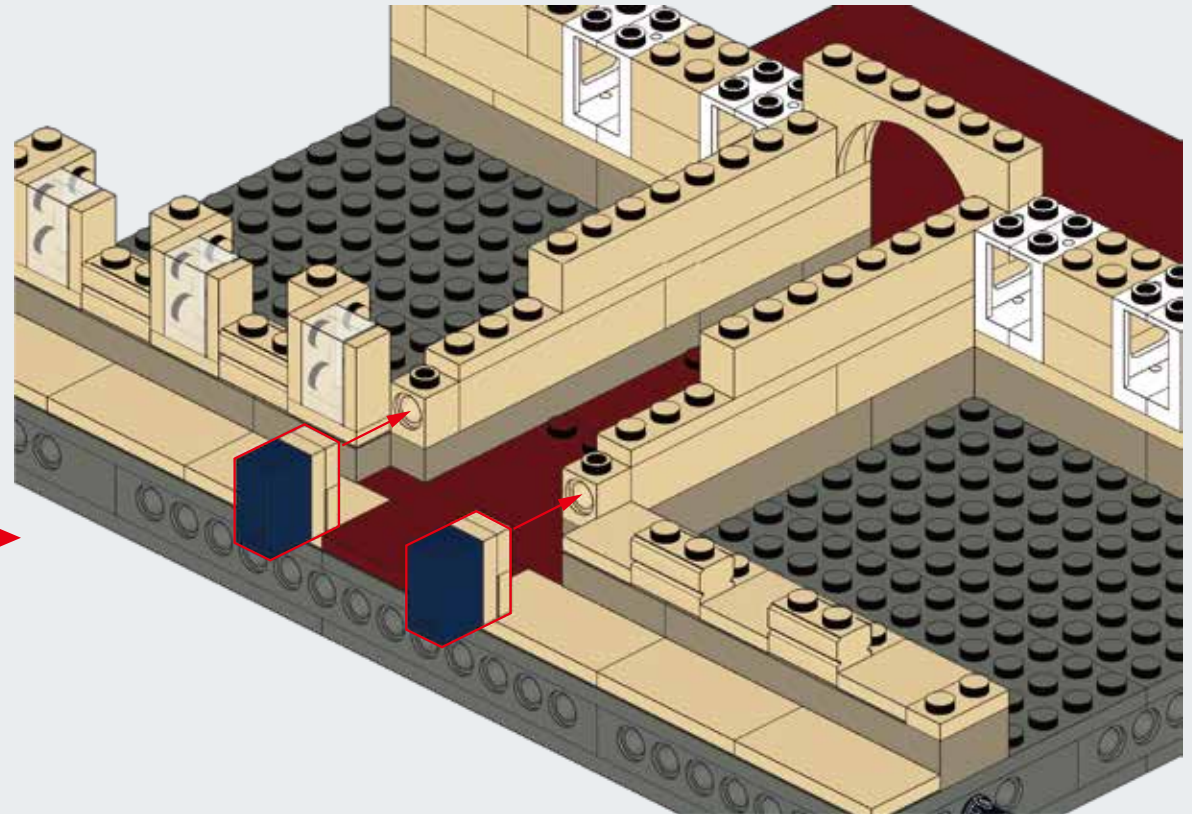
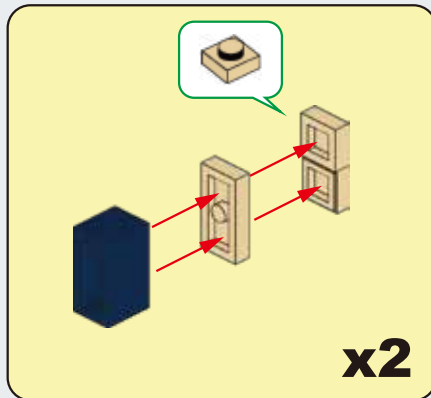

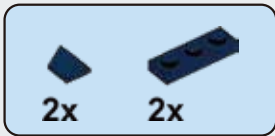

B35

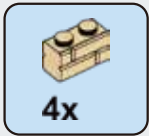
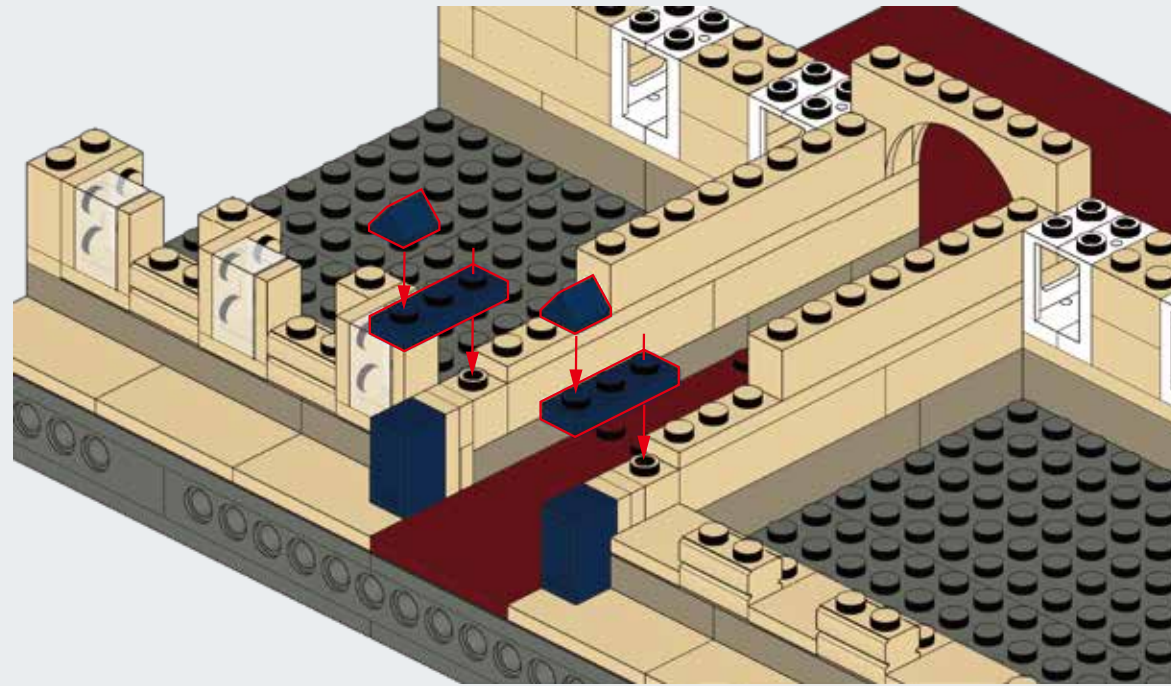

B36

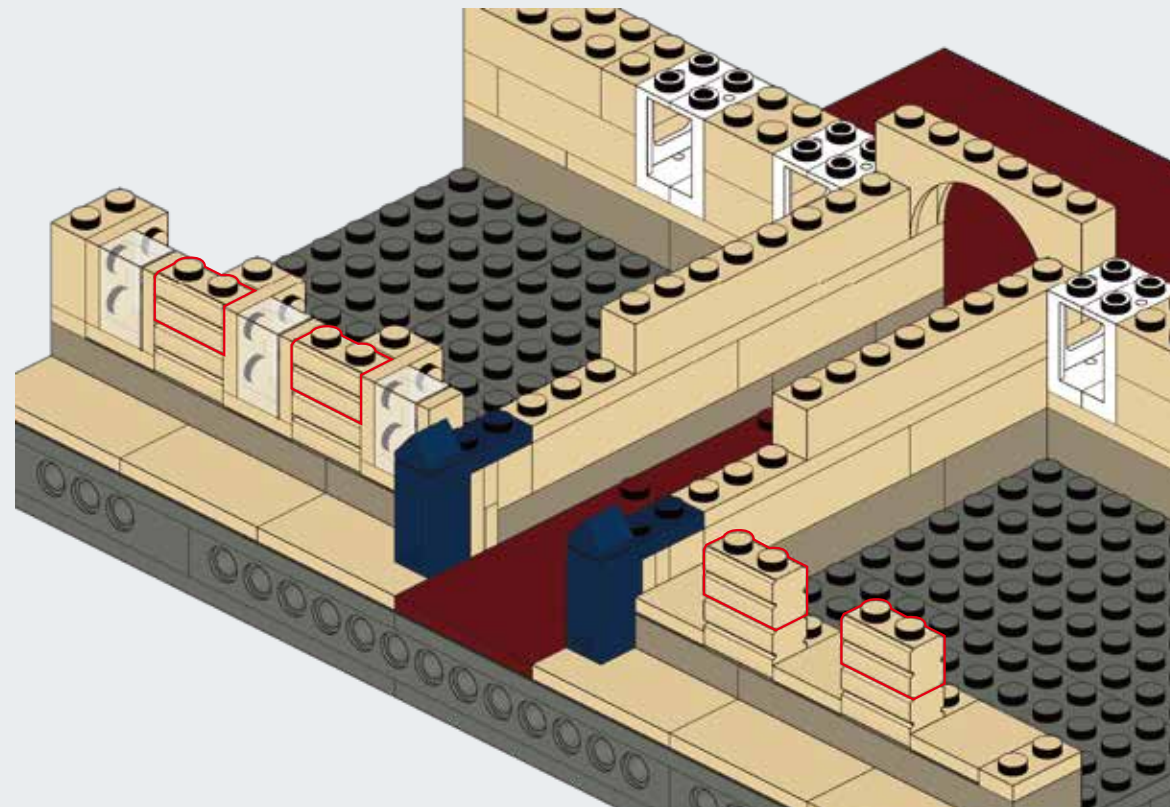

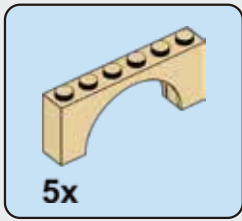

B37

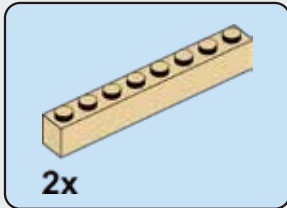
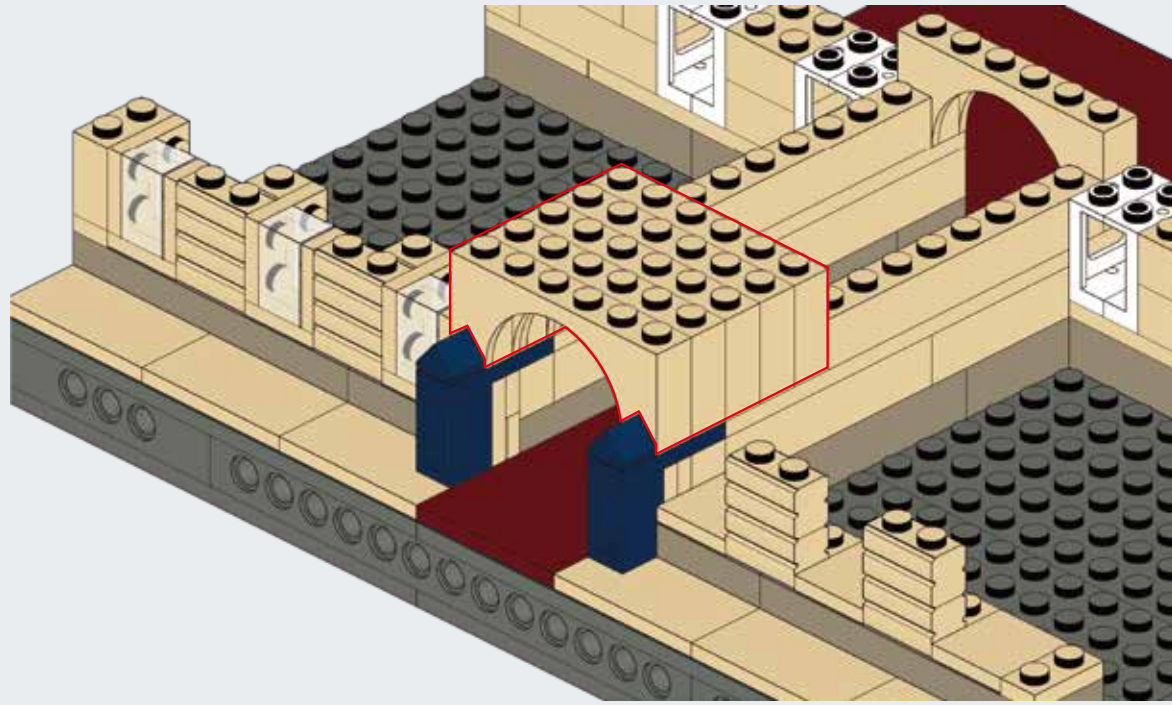

B38

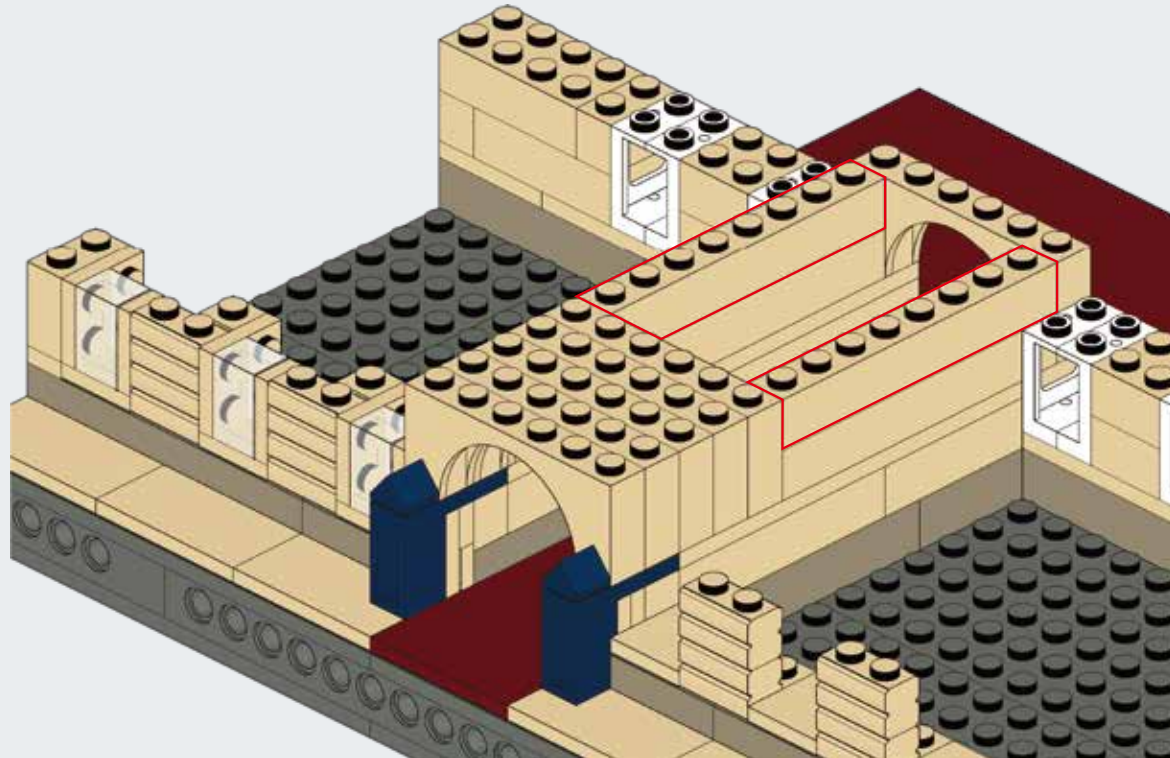

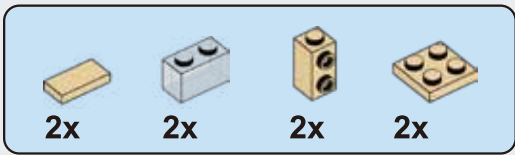

B39

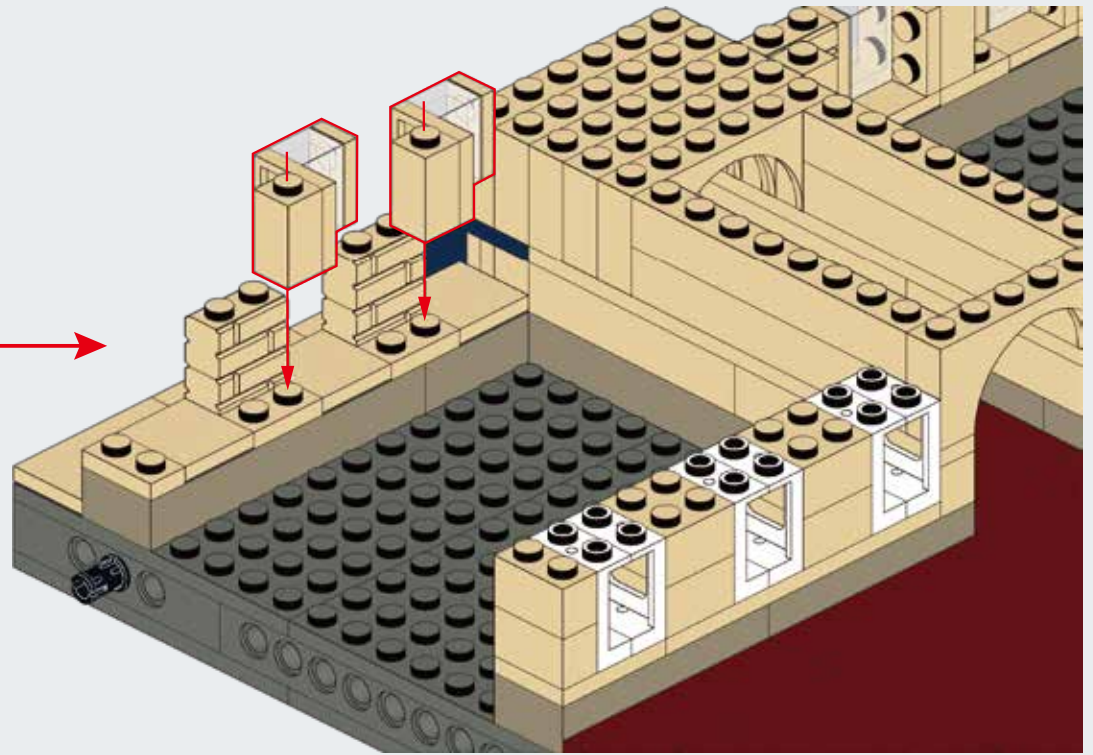
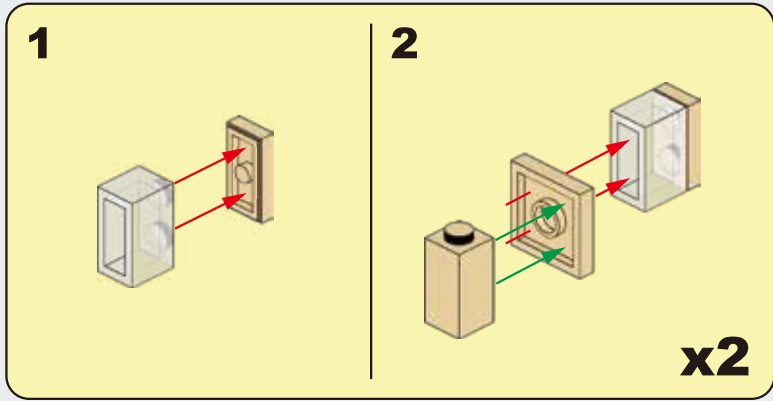

B40

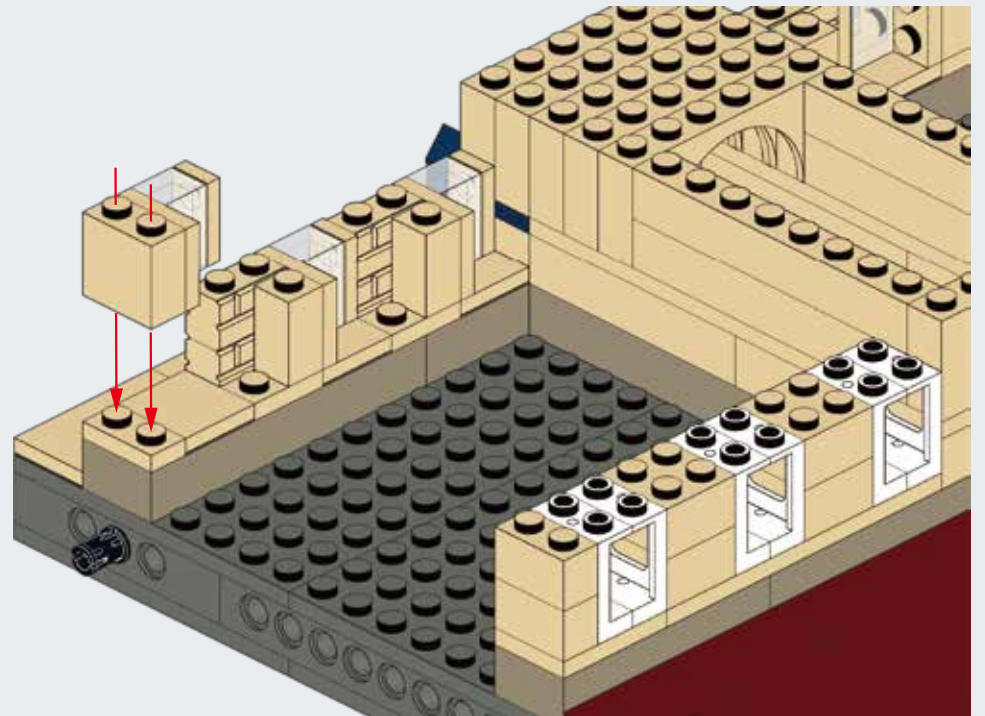
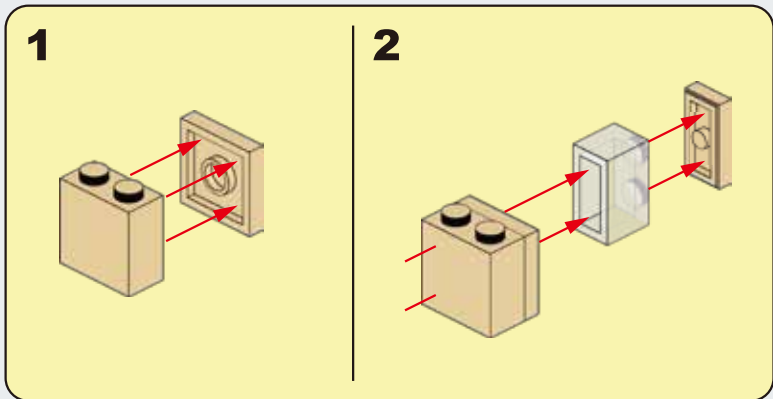

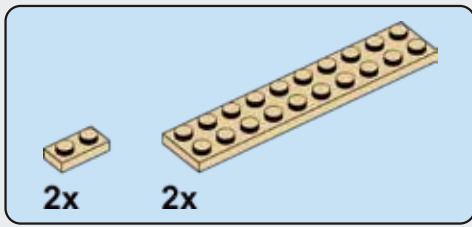

B41

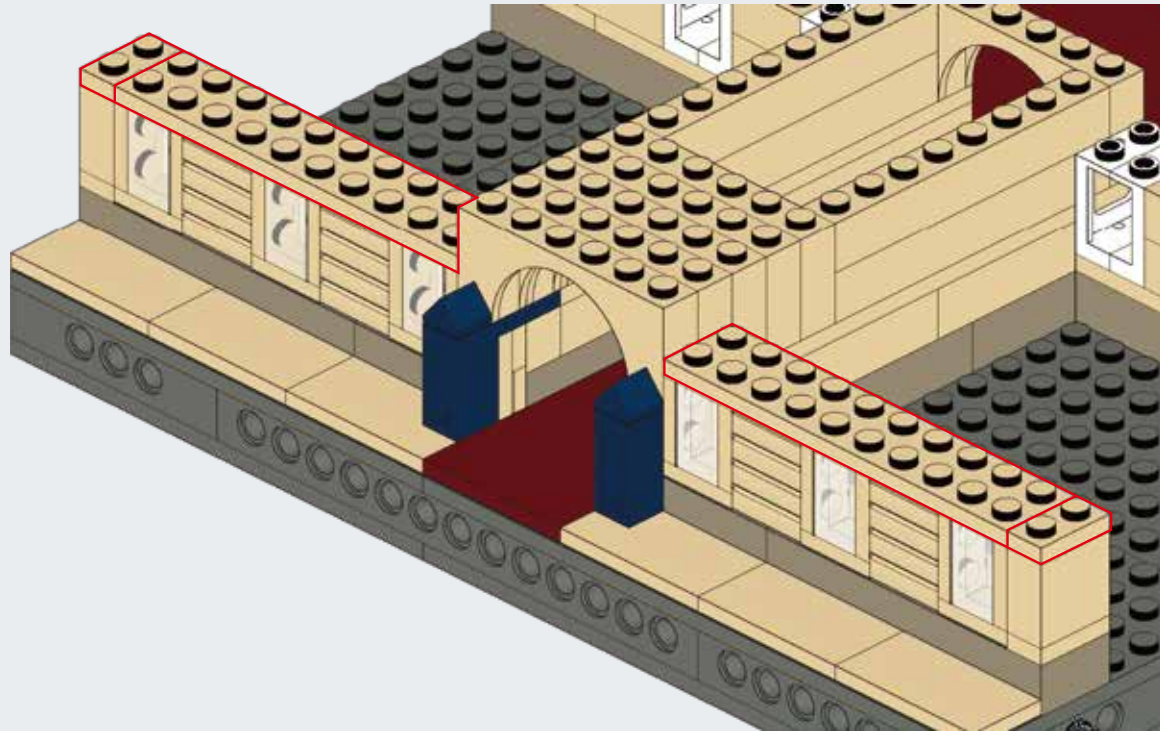
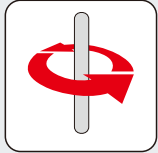

B42

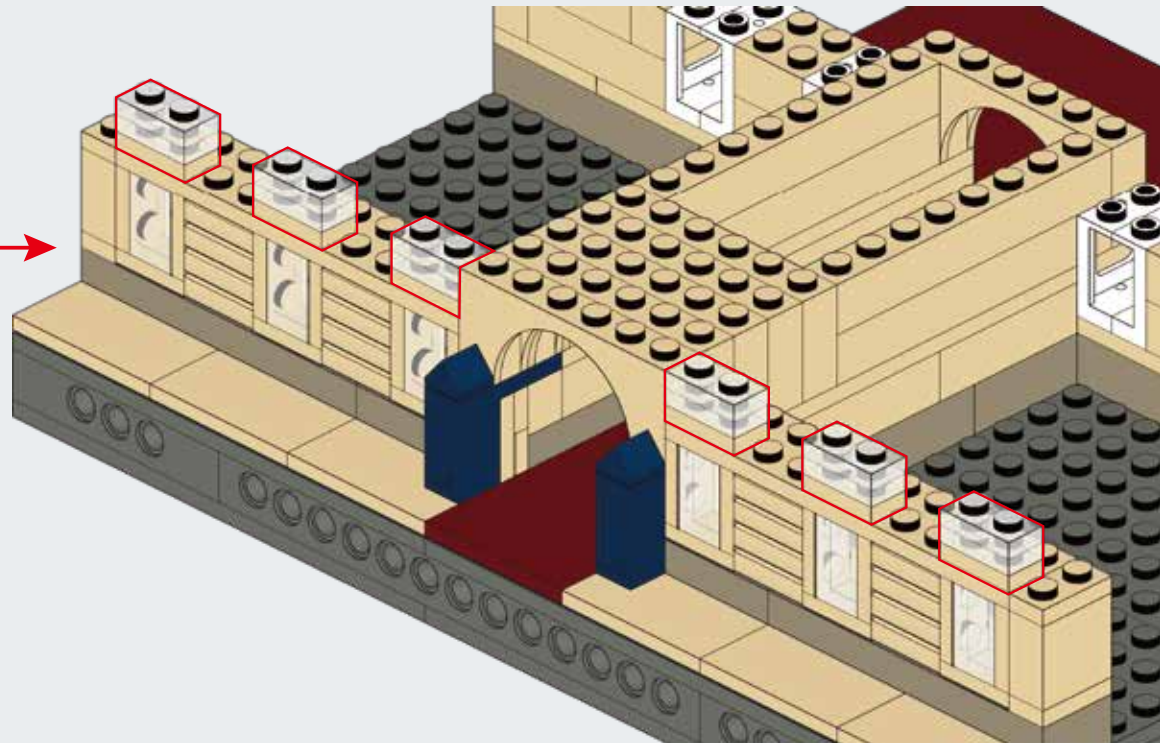
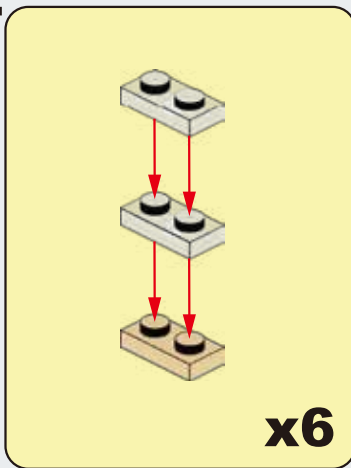

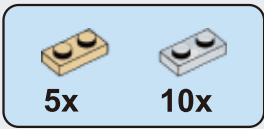

B43

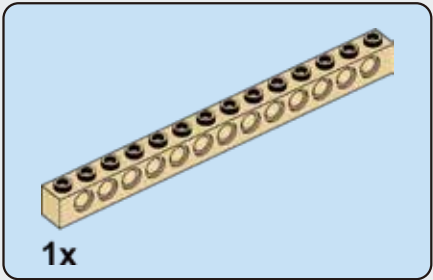
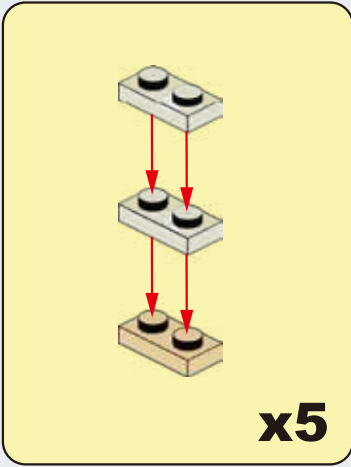

B44

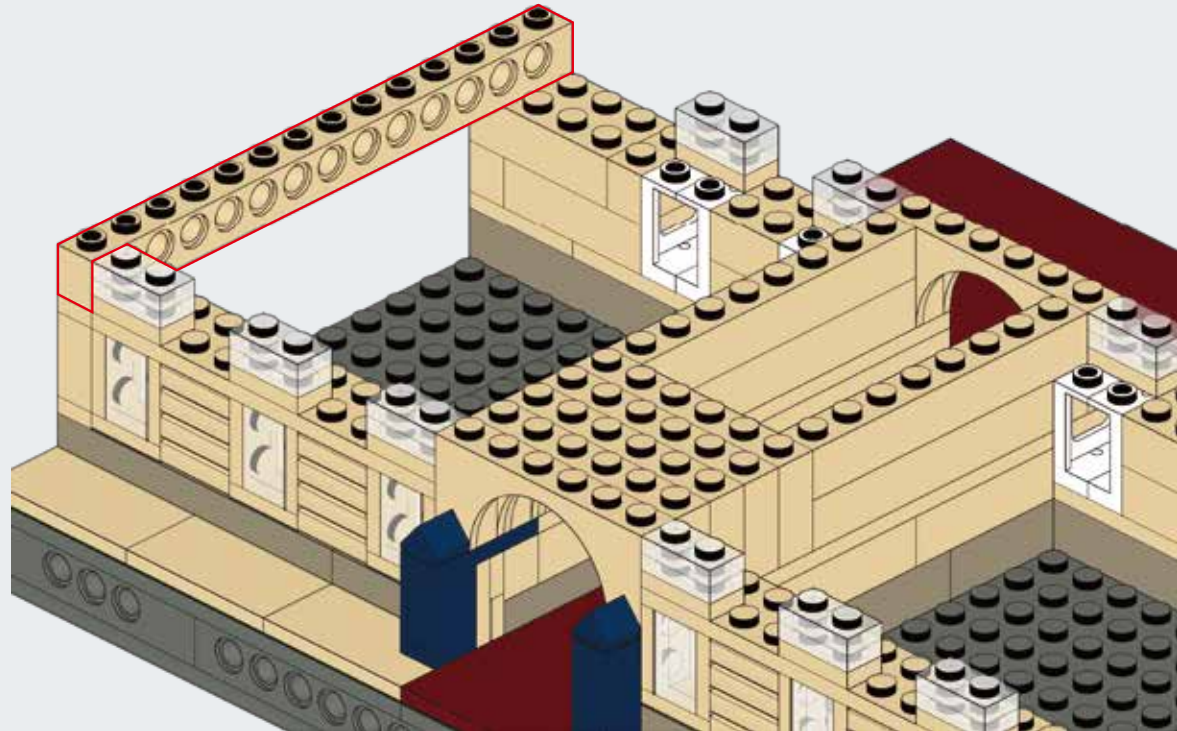

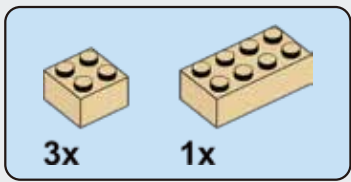

B45

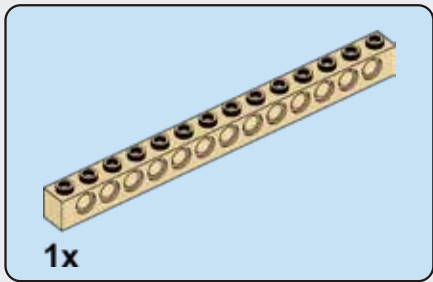
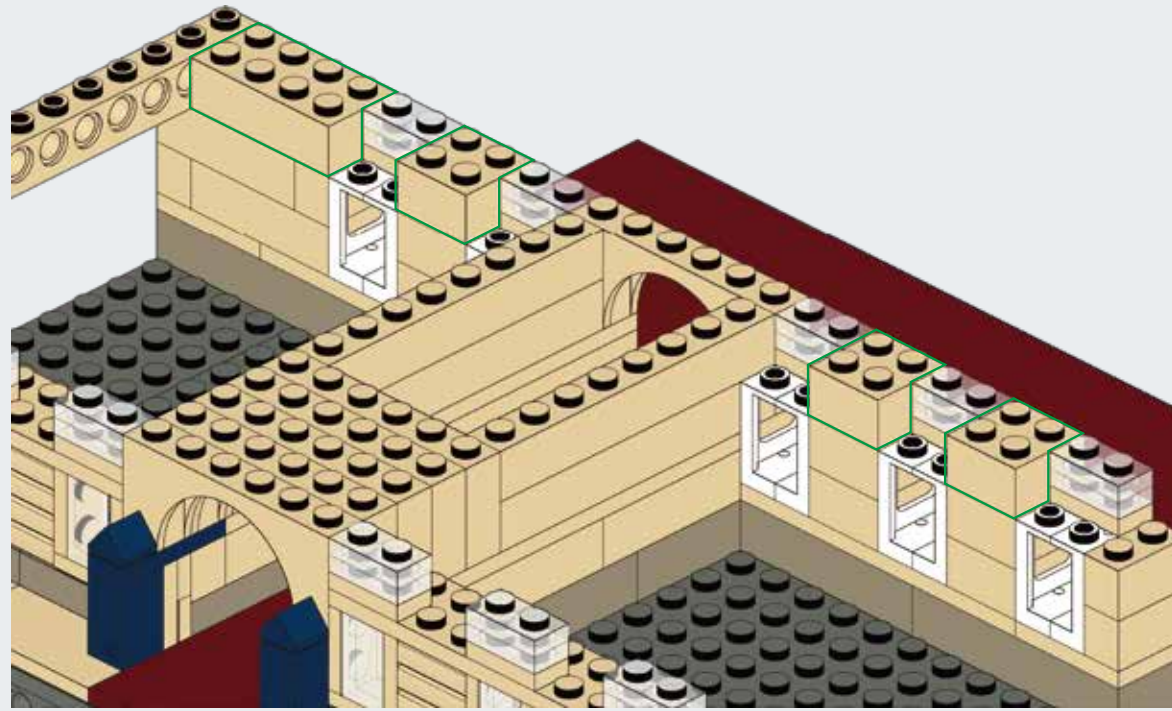

B46

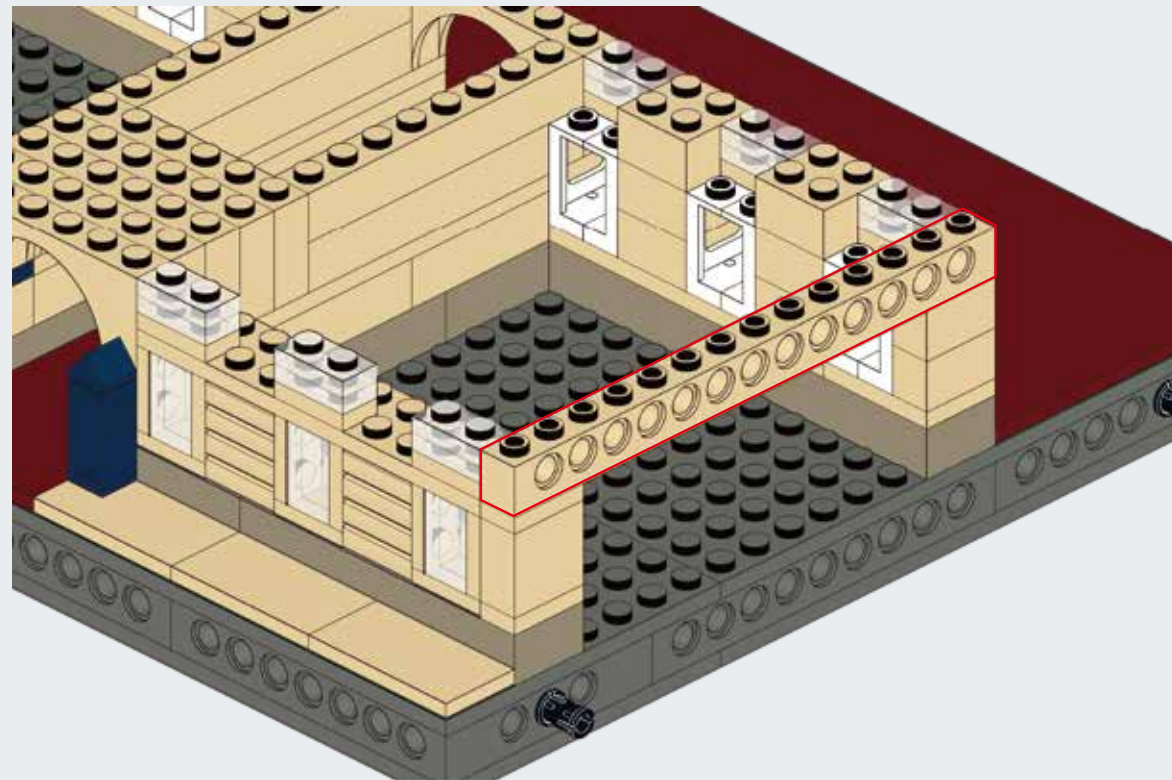



4x

B47

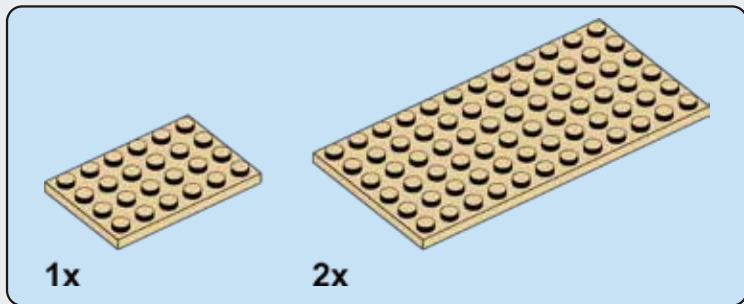
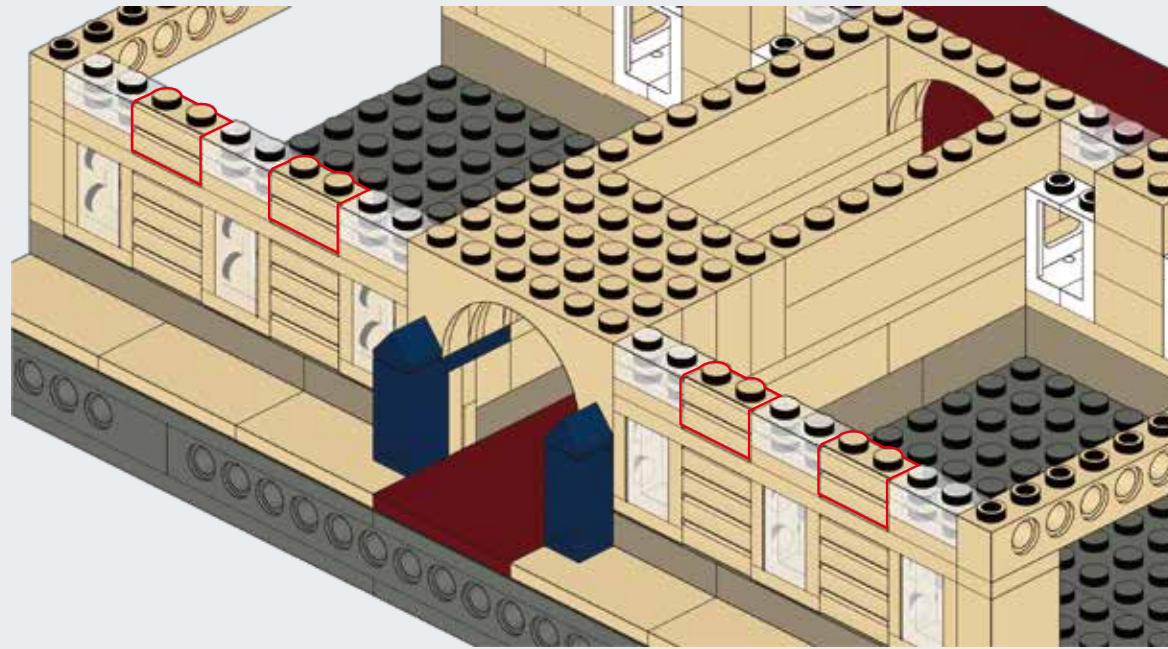

1x

2x

B48



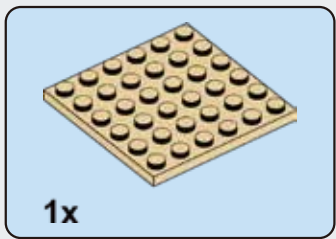

B49



B50



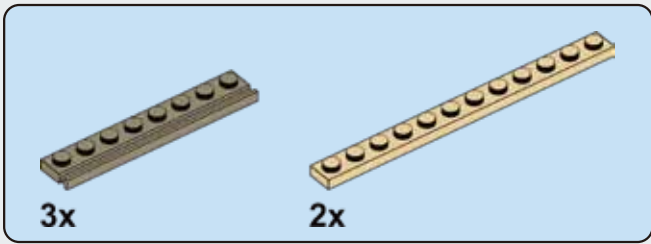

B51

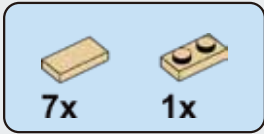
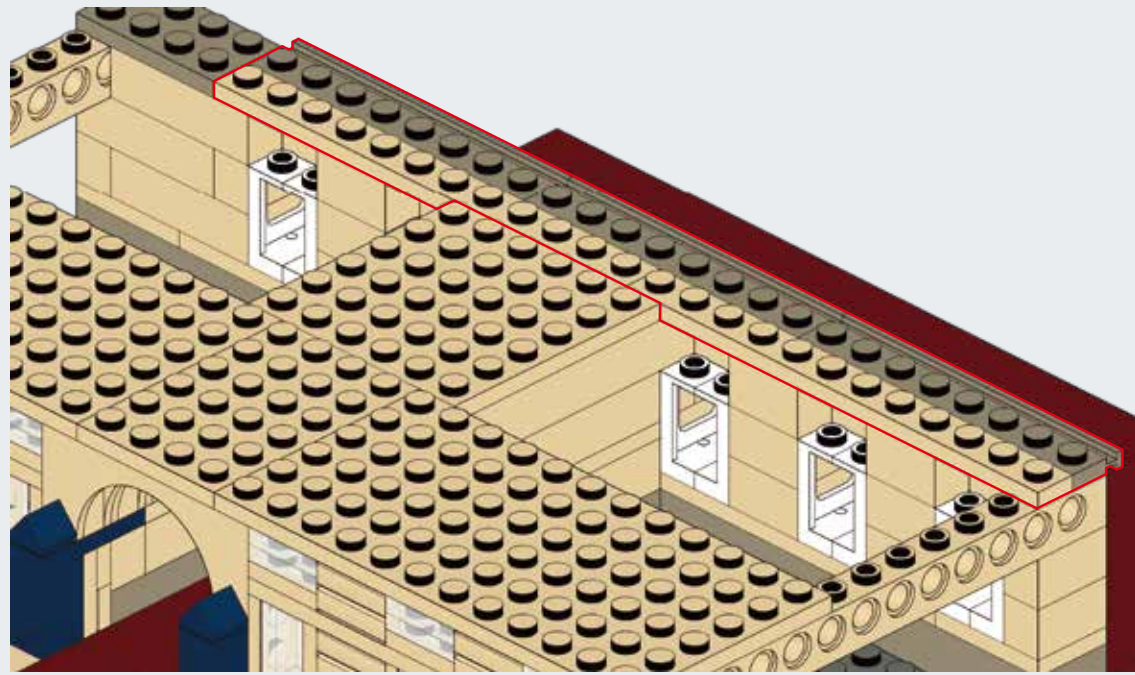

B52



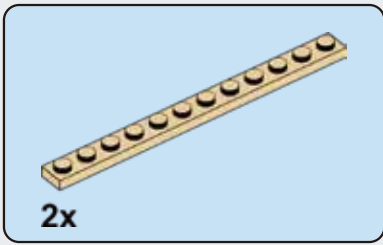

B53

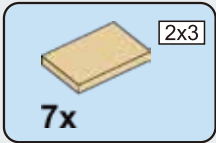
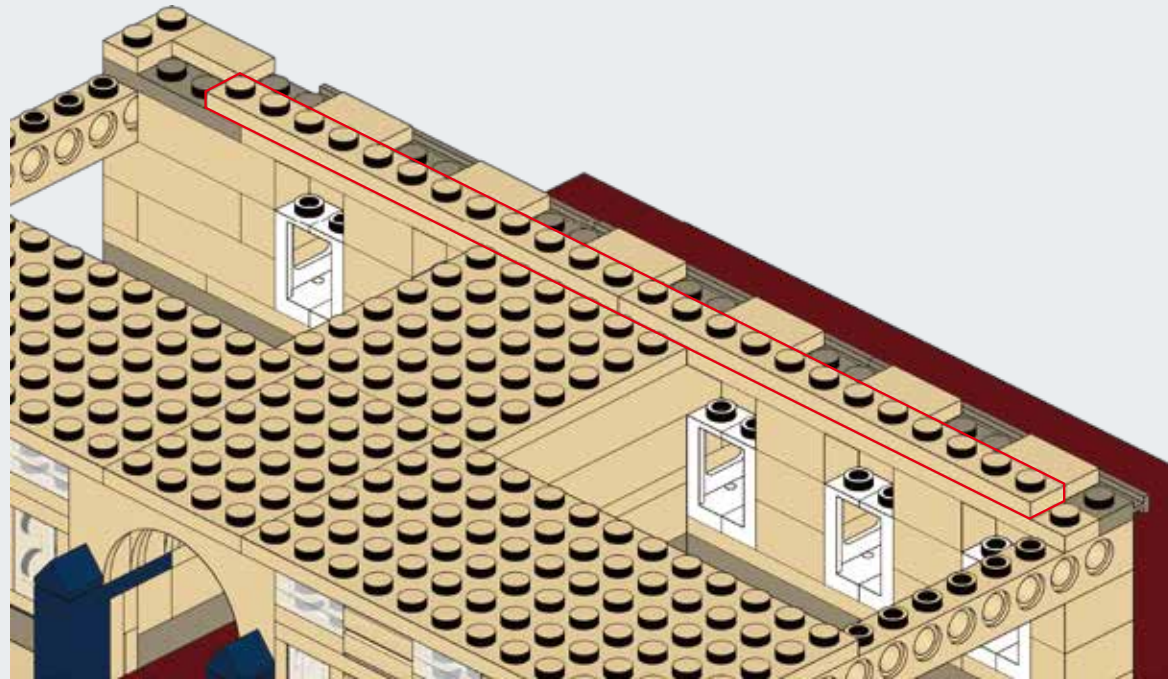

B54

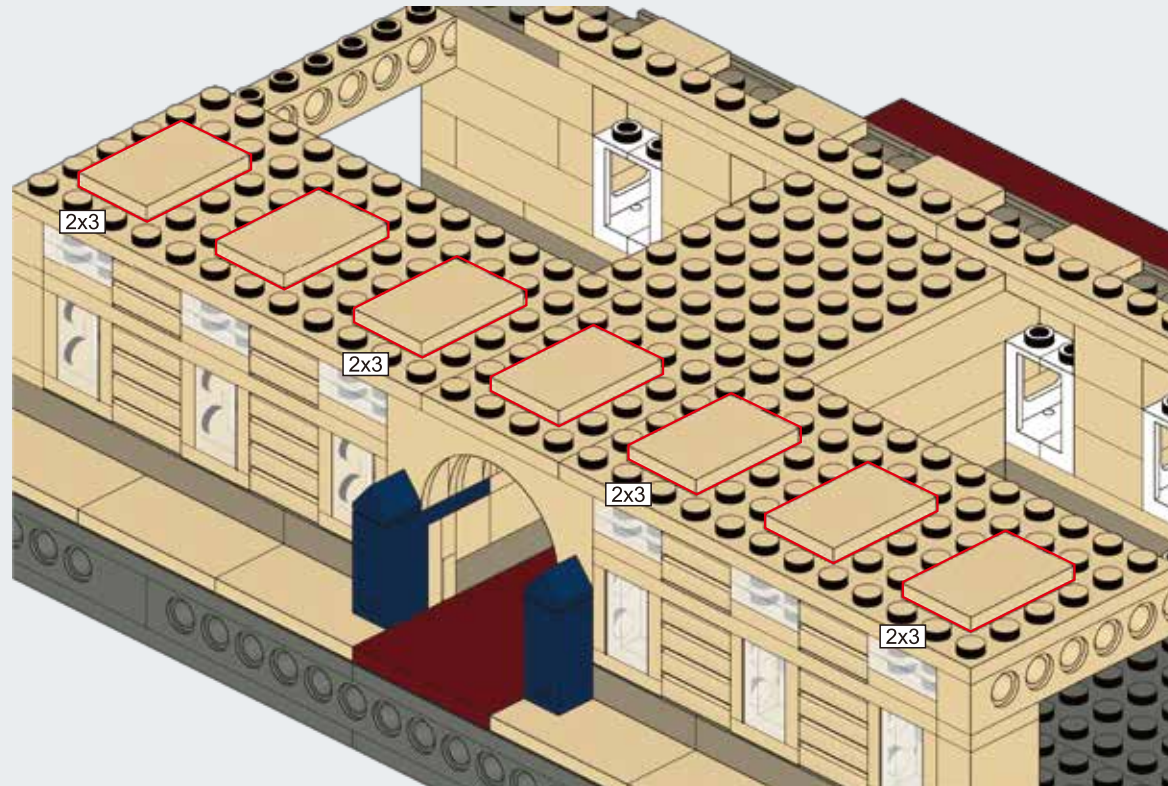

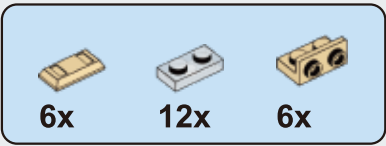

B55

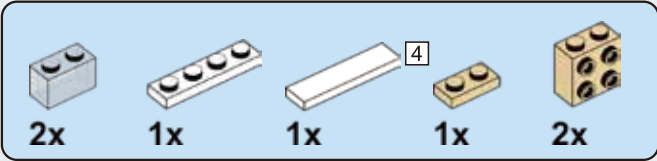
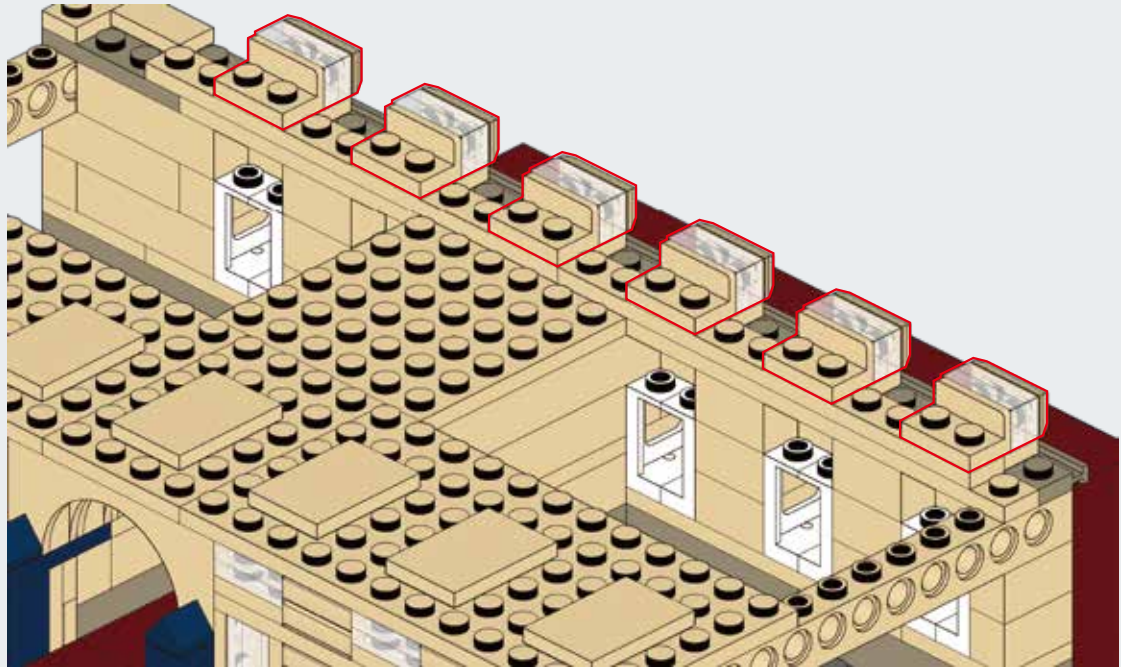
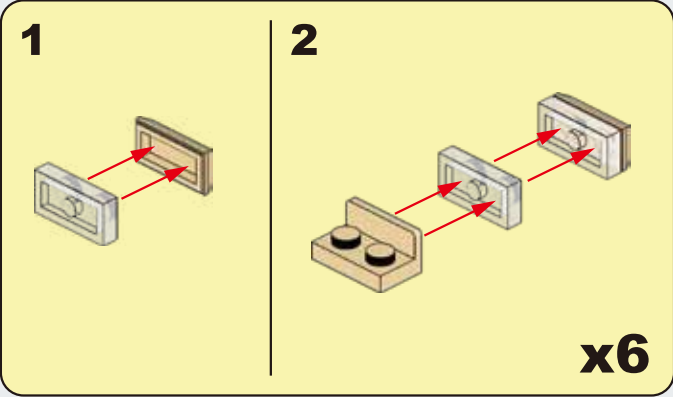

B56

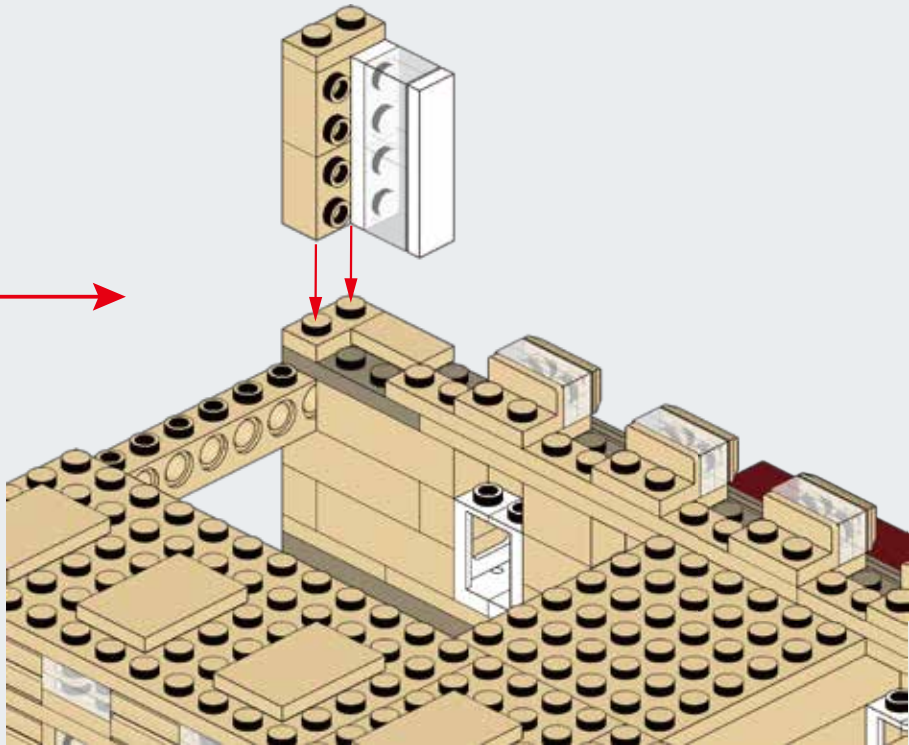
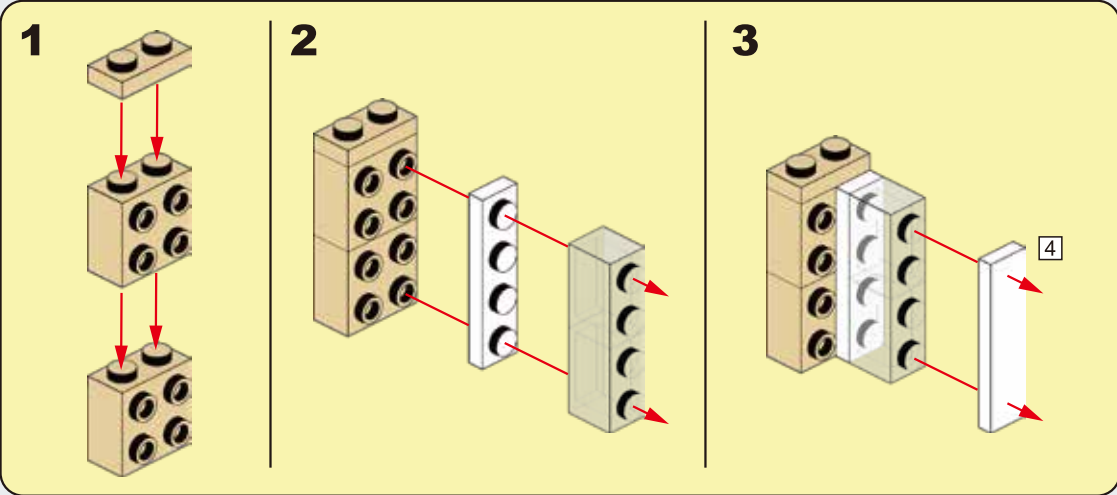



B57

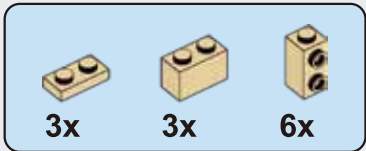
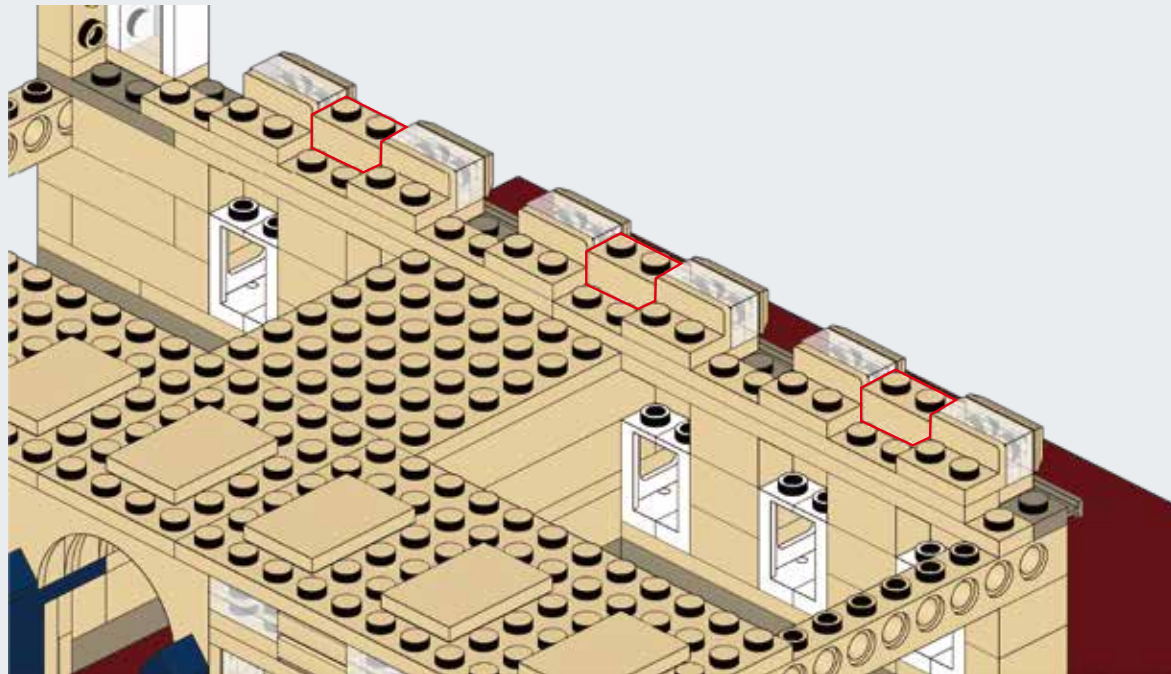

B58

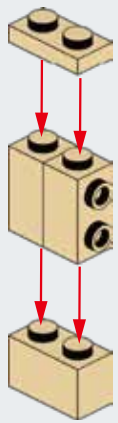

x3

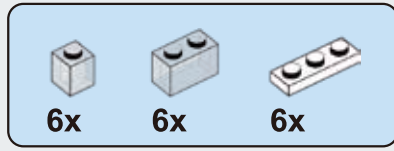

B59

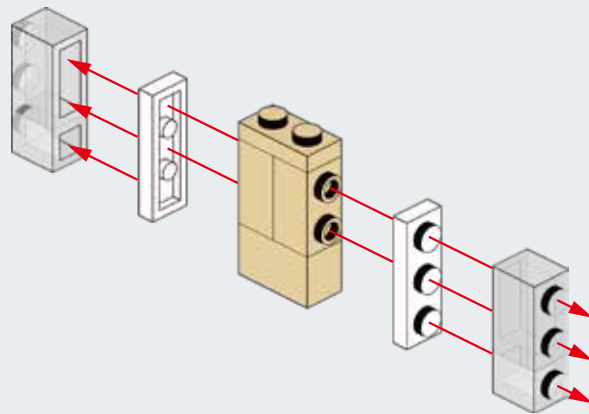

x3

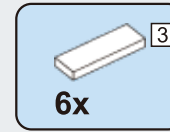

B60

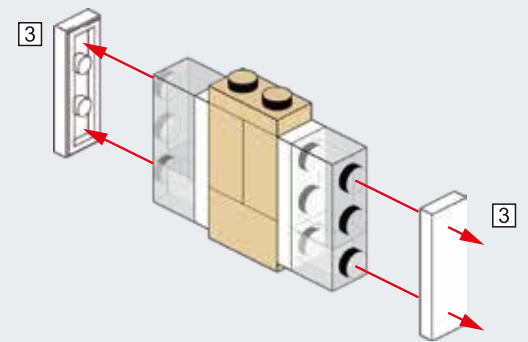

x3

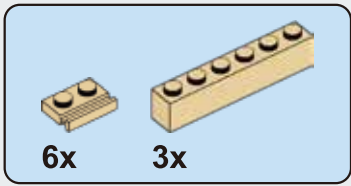

B61

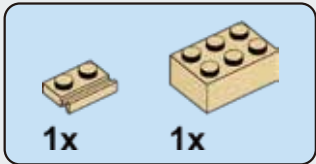
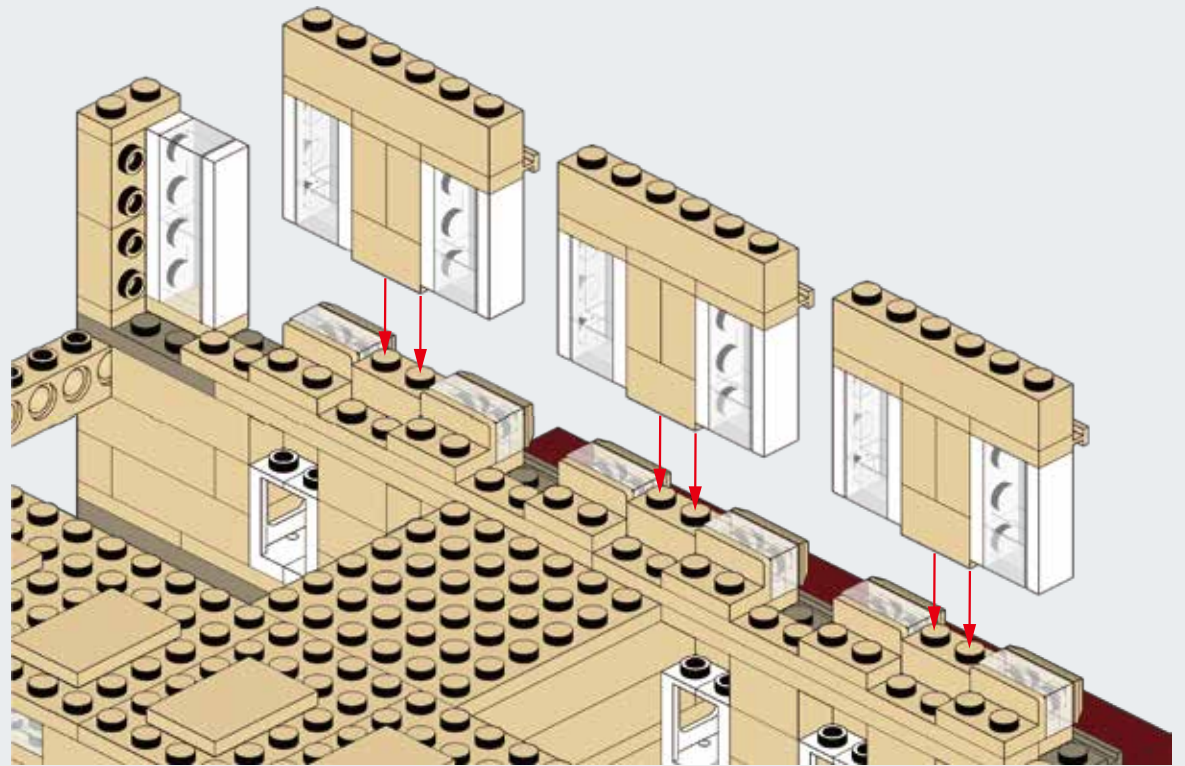
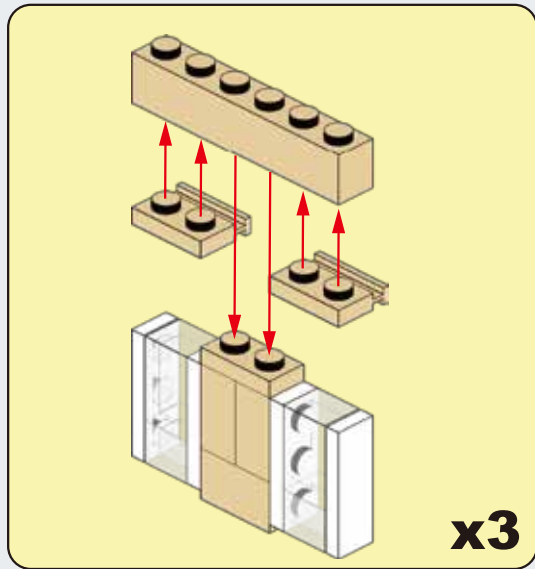

B62

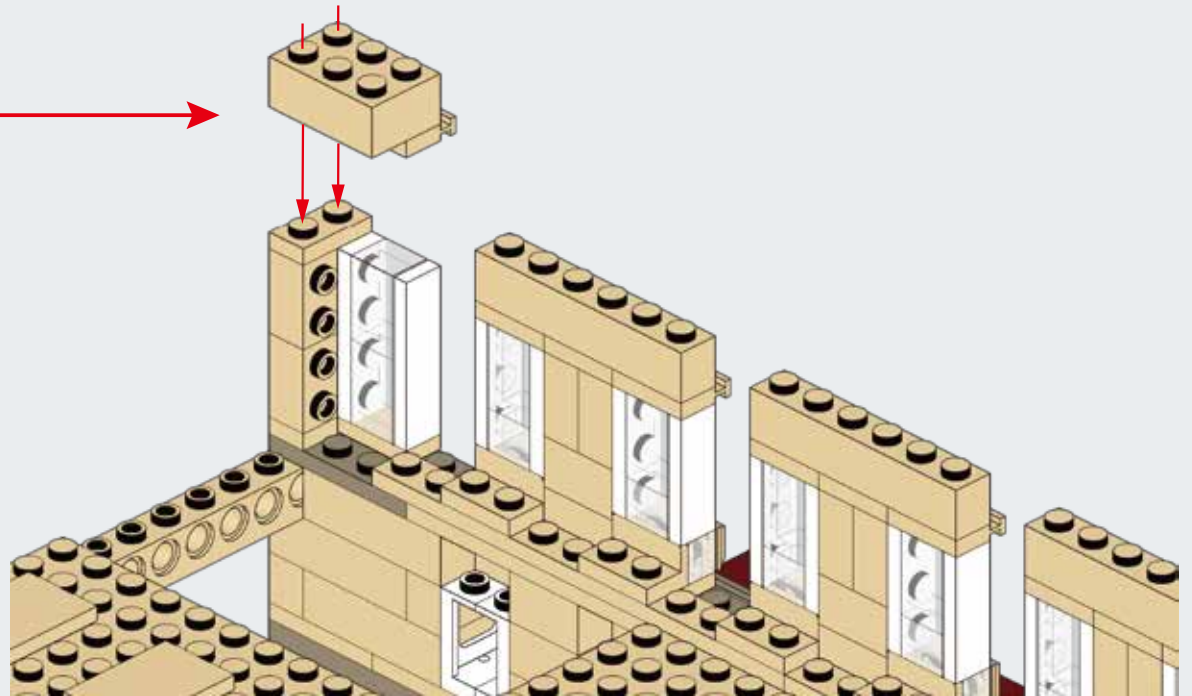
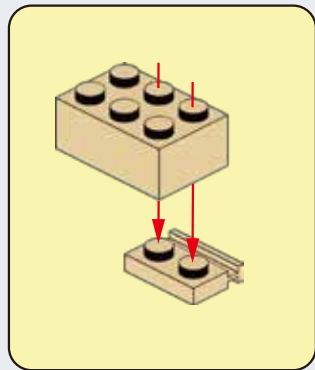



Buckingham Palace



Please download the building instruction from below website.

en.doubleeagle-group.com

403ARC615010002

C61501

5604PCS

Designer: Tobias Thieme