

# CaDA

## Designer Introduction

---

Hello everyone,

My name is Tobias Thieme and I work at an IT/Automotive company in Germany. System Bricks were my favorite toy growing up, but as I got older, other things became more important. In 2013, I rediscovered them, quickly getting lost in the new possibilities and the amazing creations I saw in the online brick community. Soon I started creating and sharing my own designs as well.

I love to create detailed buildings with interesting architectural features. I strive to include unusual and creative building techniques whenever feasible without sacrificing overall stability.

I feel very honored that CaDA asked me to do a set with them. It is a dream come true and I hope that more fan designers will get the same opportunity.

I hope building this set brings you as much joy as I had designing it !

Designer: Tobias Thieme



1

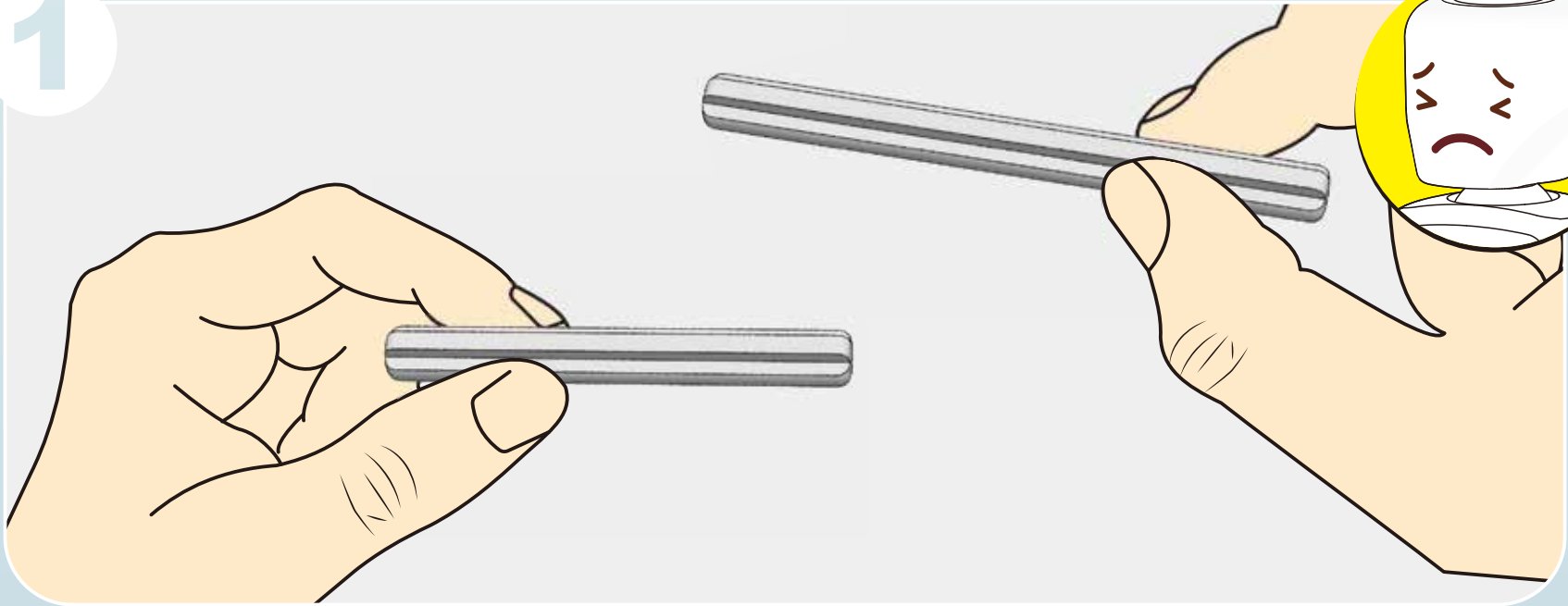

2

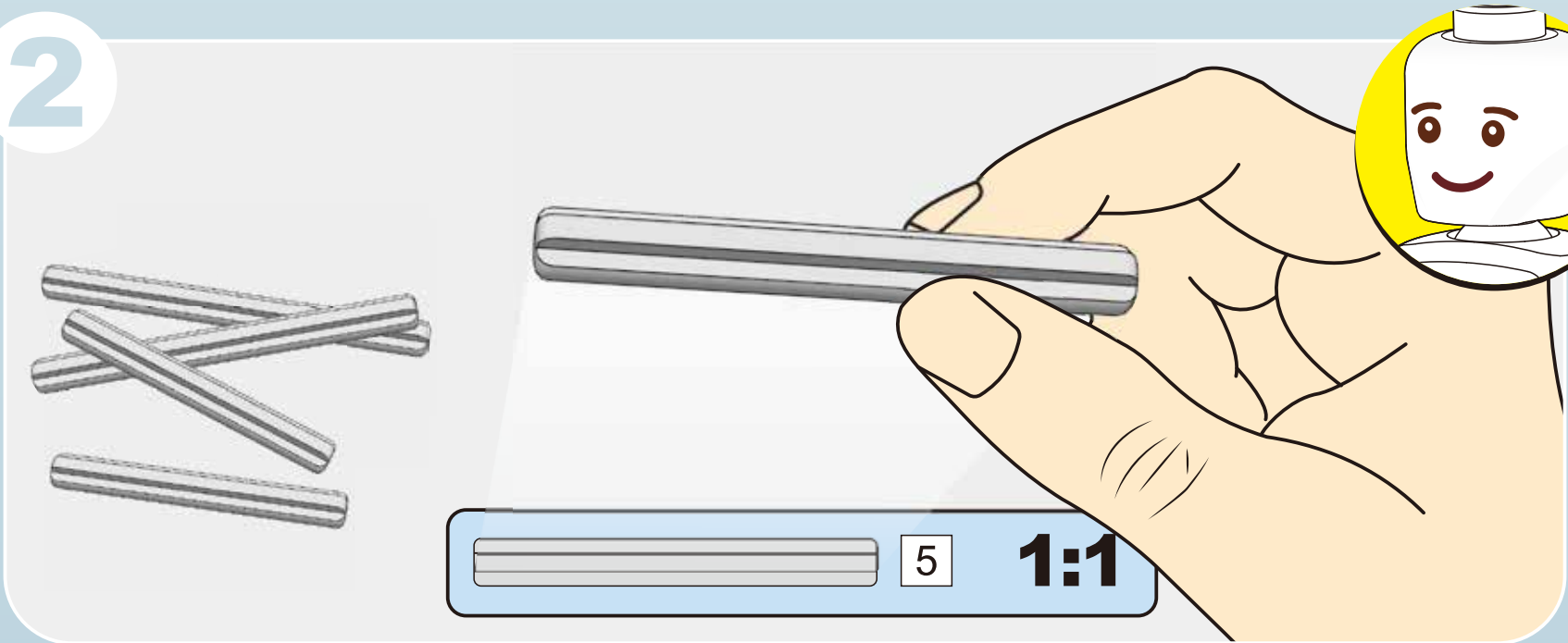

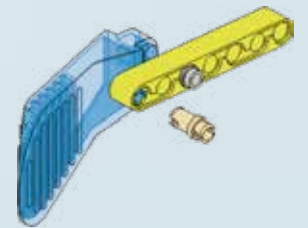
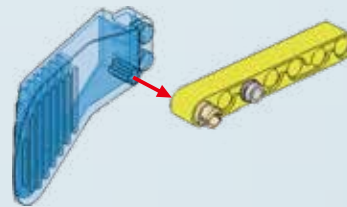
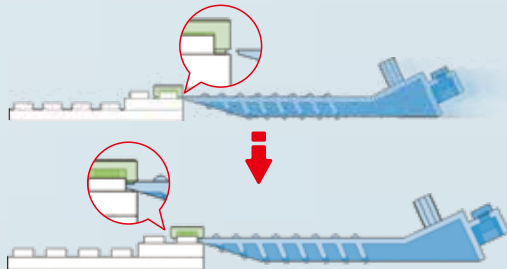
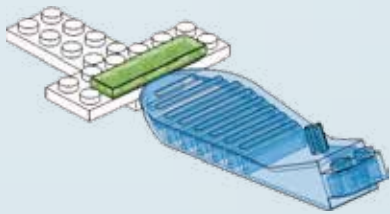
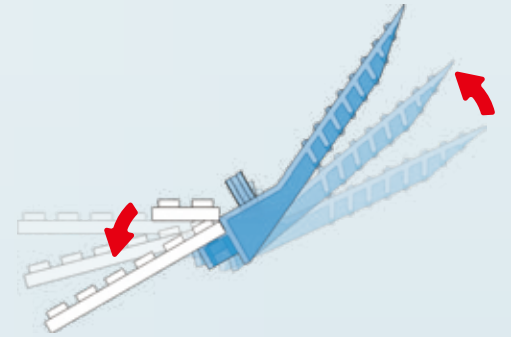
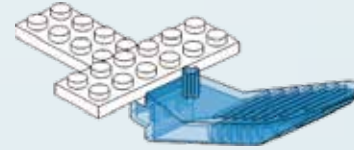
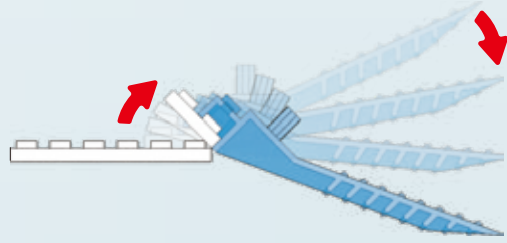
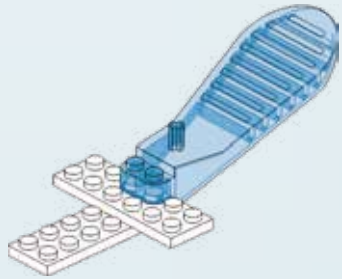



+

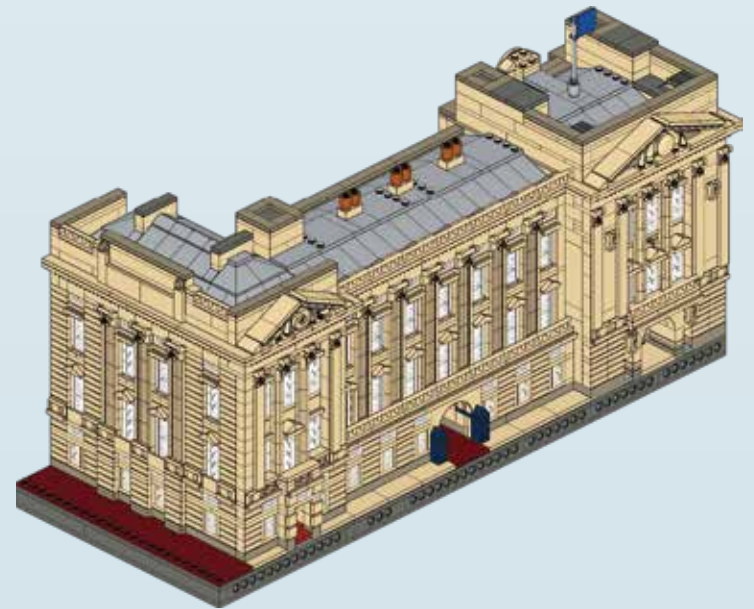



+

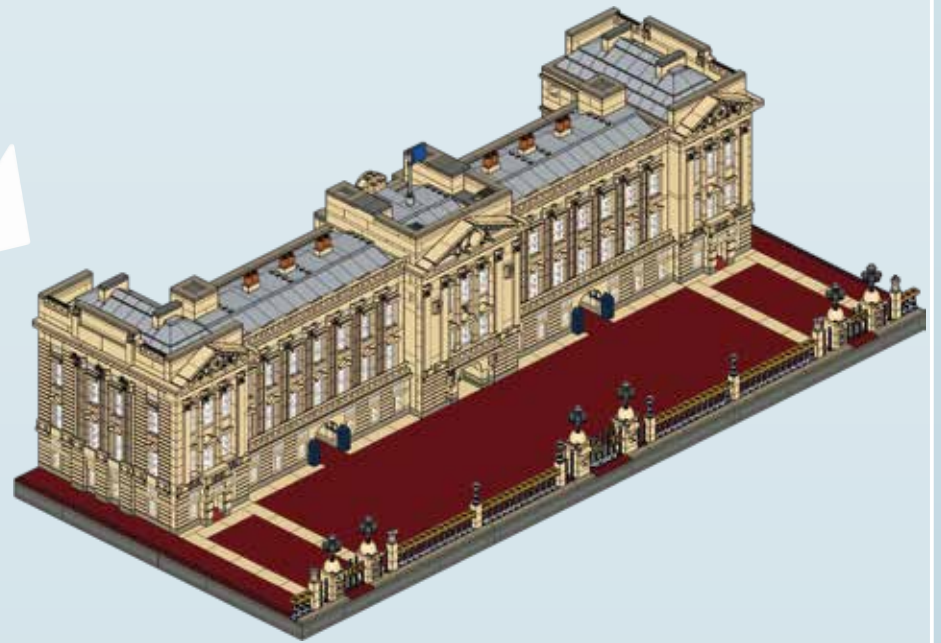

**A**

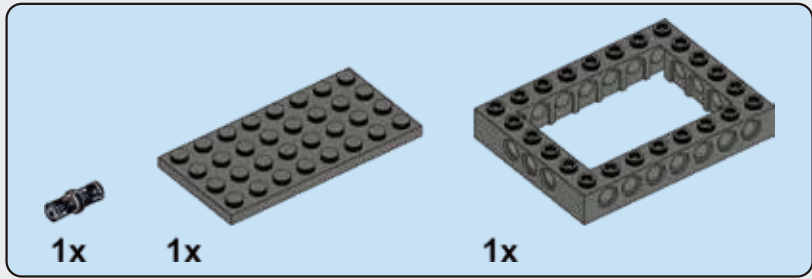

**A1**

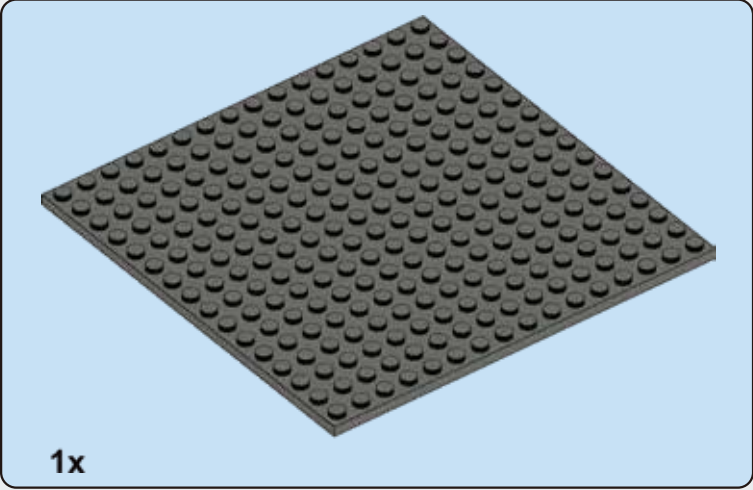
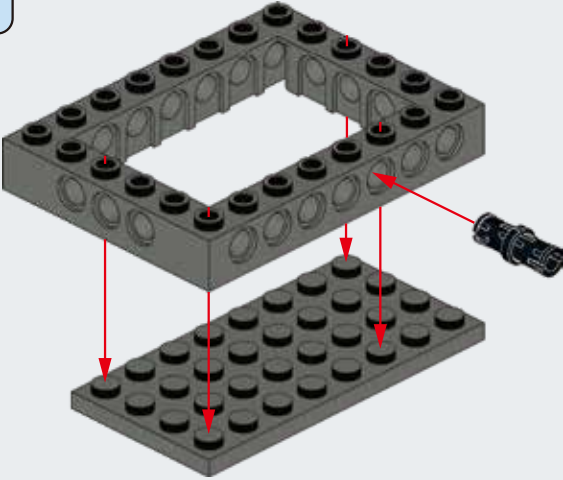

**A2**

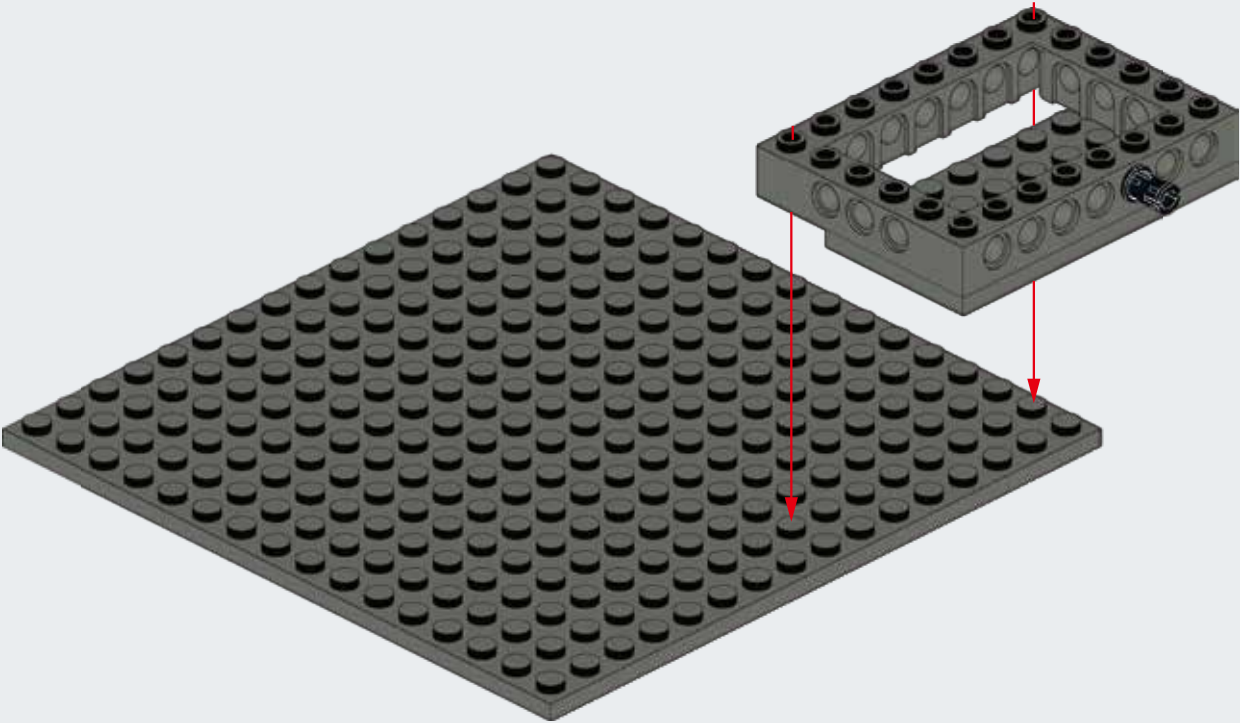

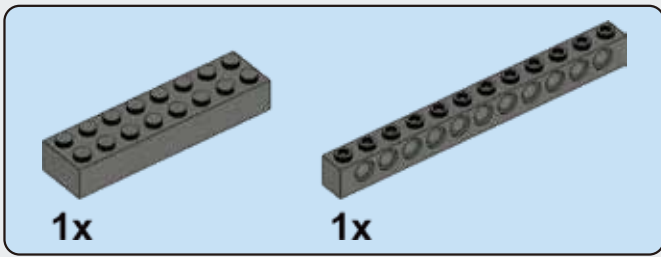

### A3

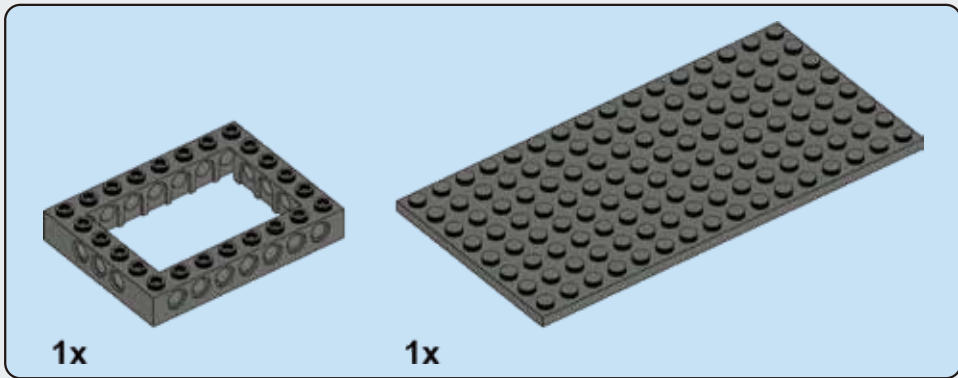
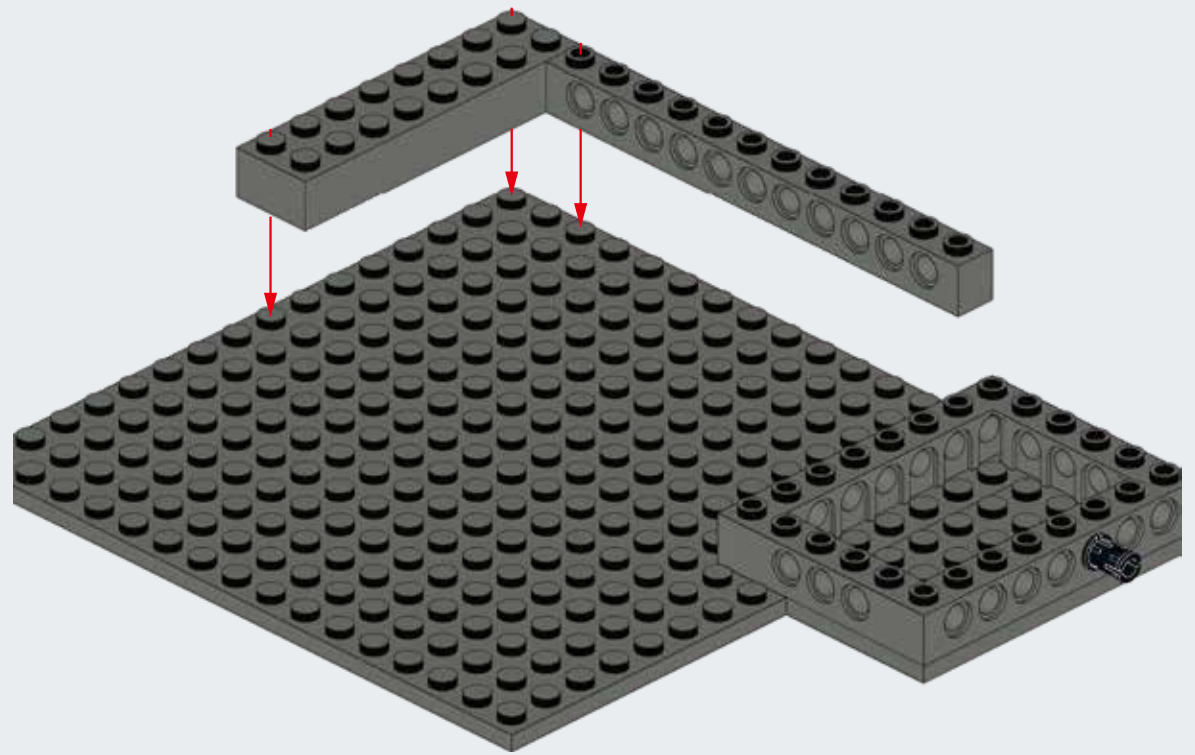

### A4

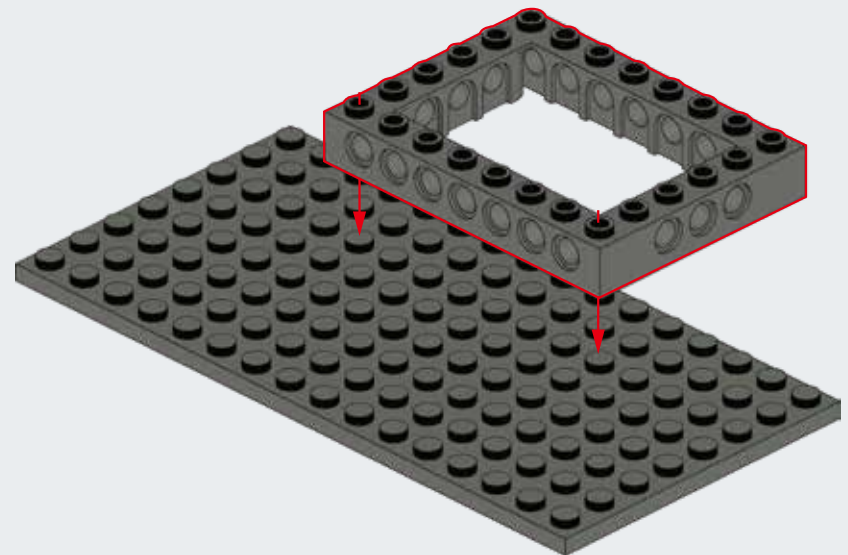

**A5**

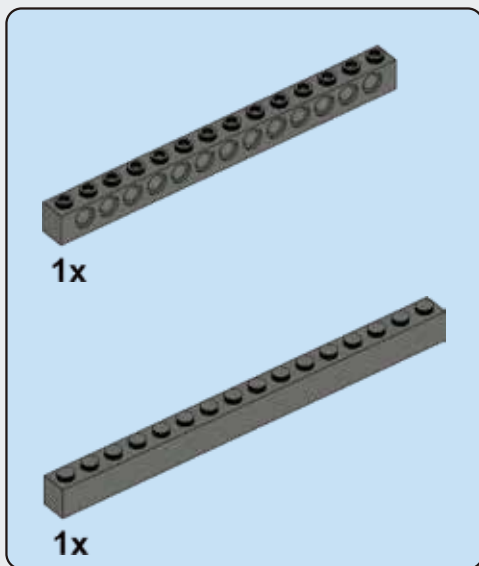
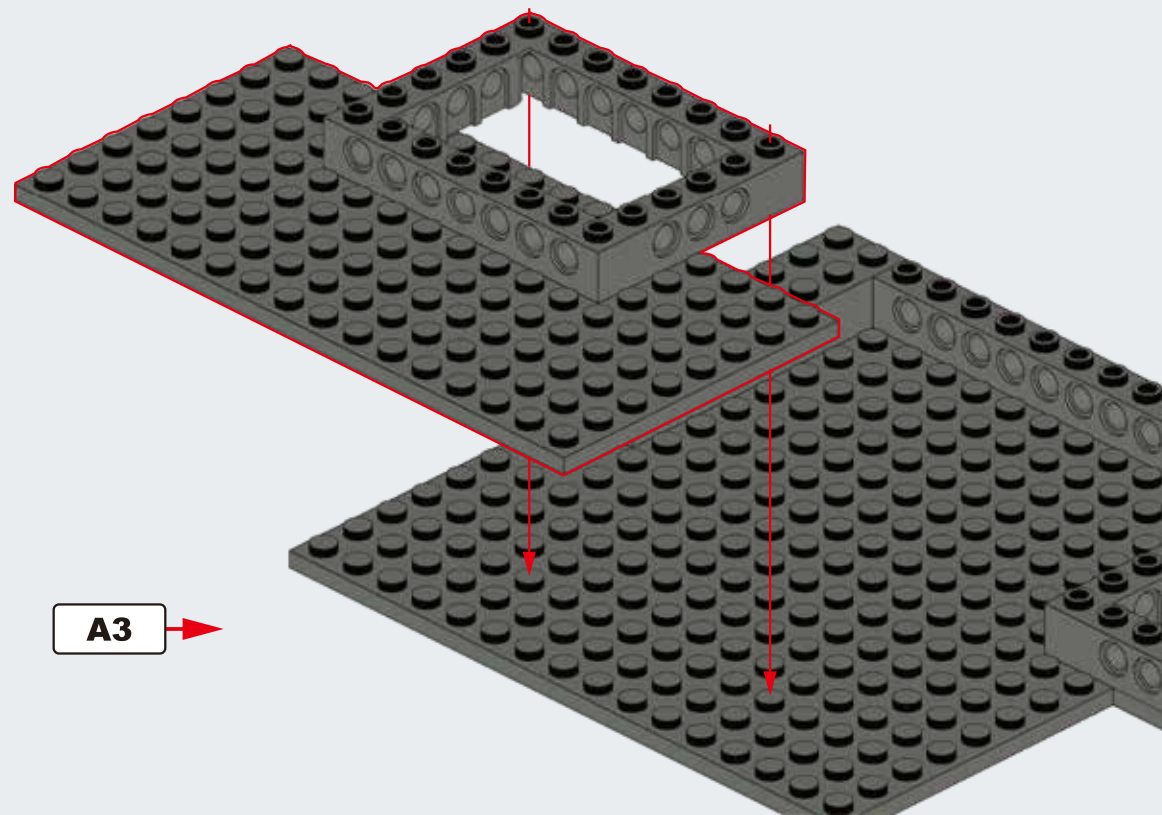

**A6**

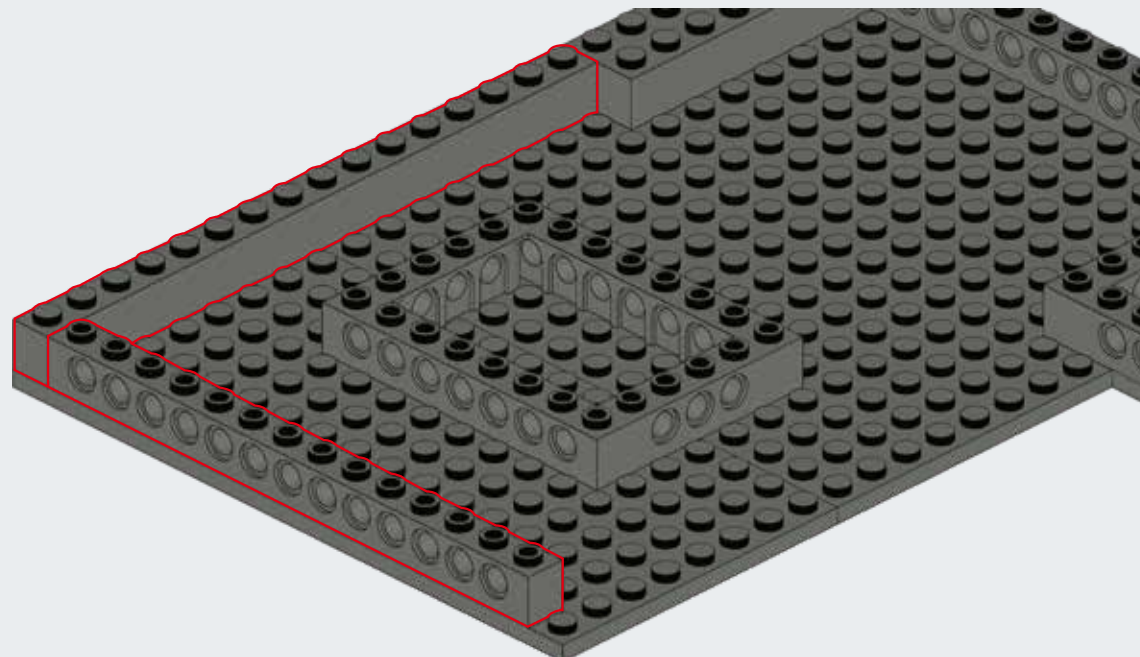



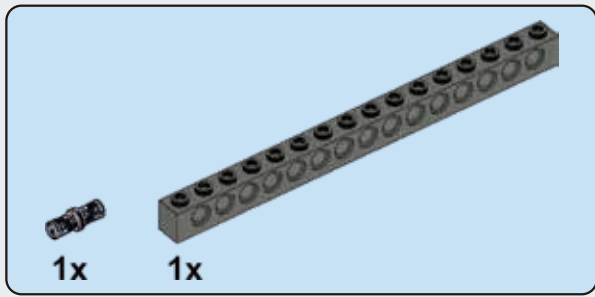

**A7**

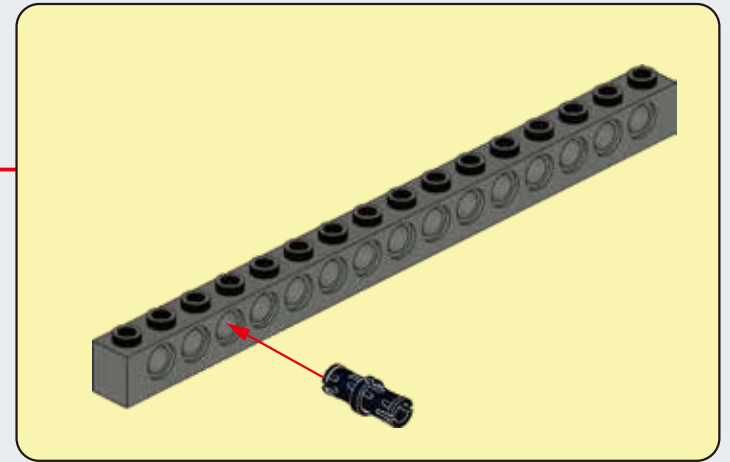
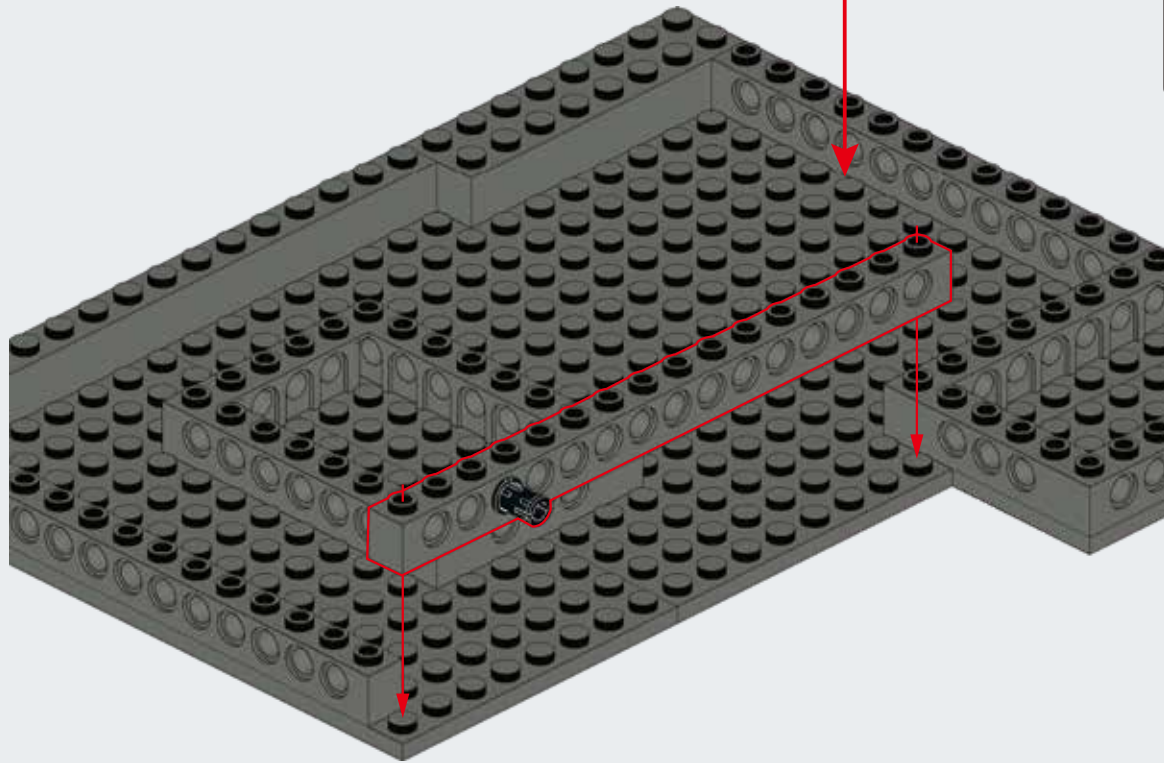

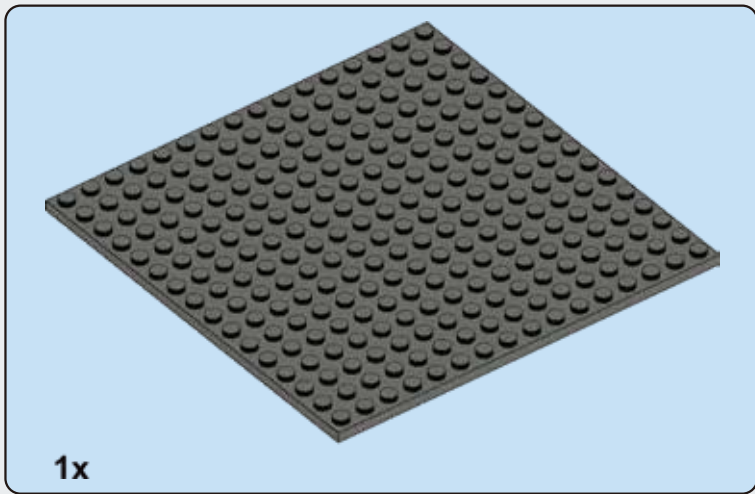

**A8**

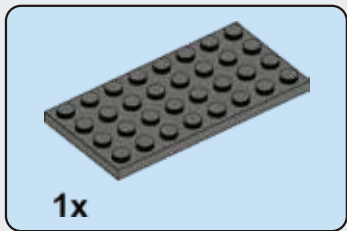
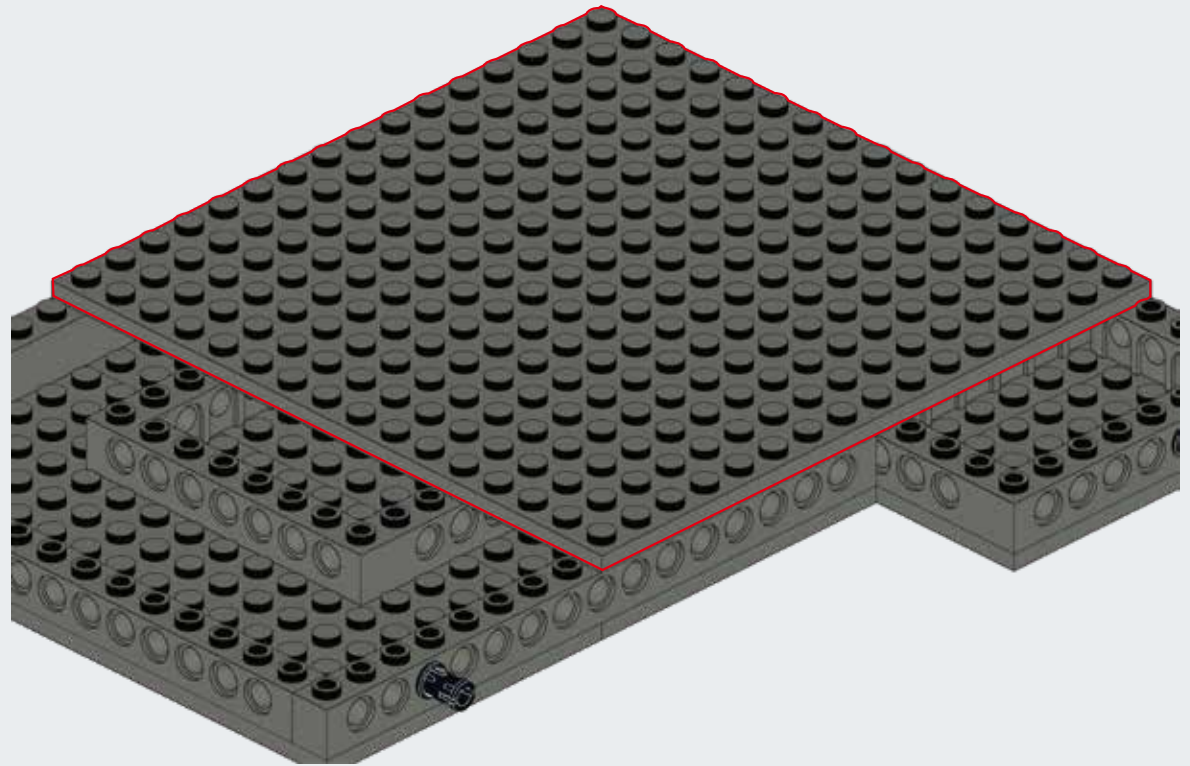

**A9**

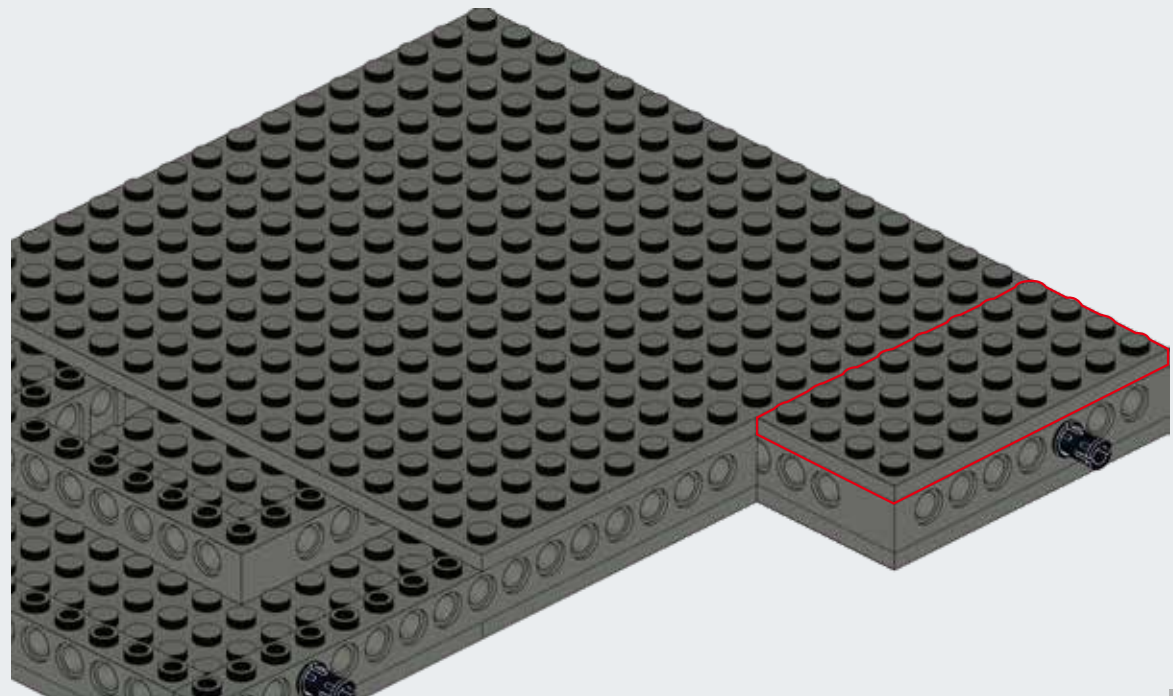

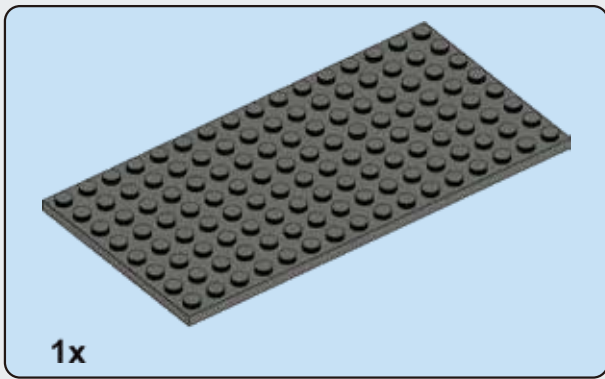

## A10

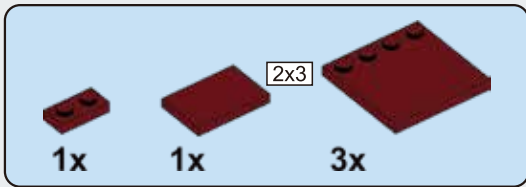
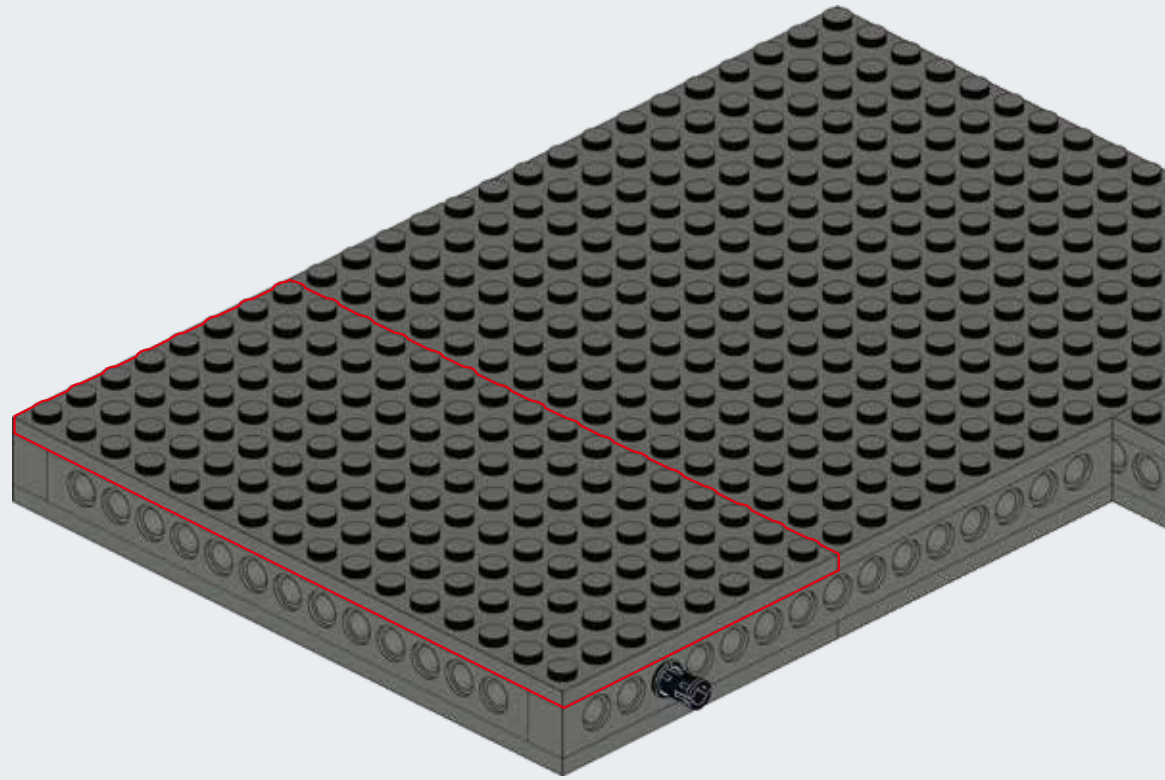

## A11

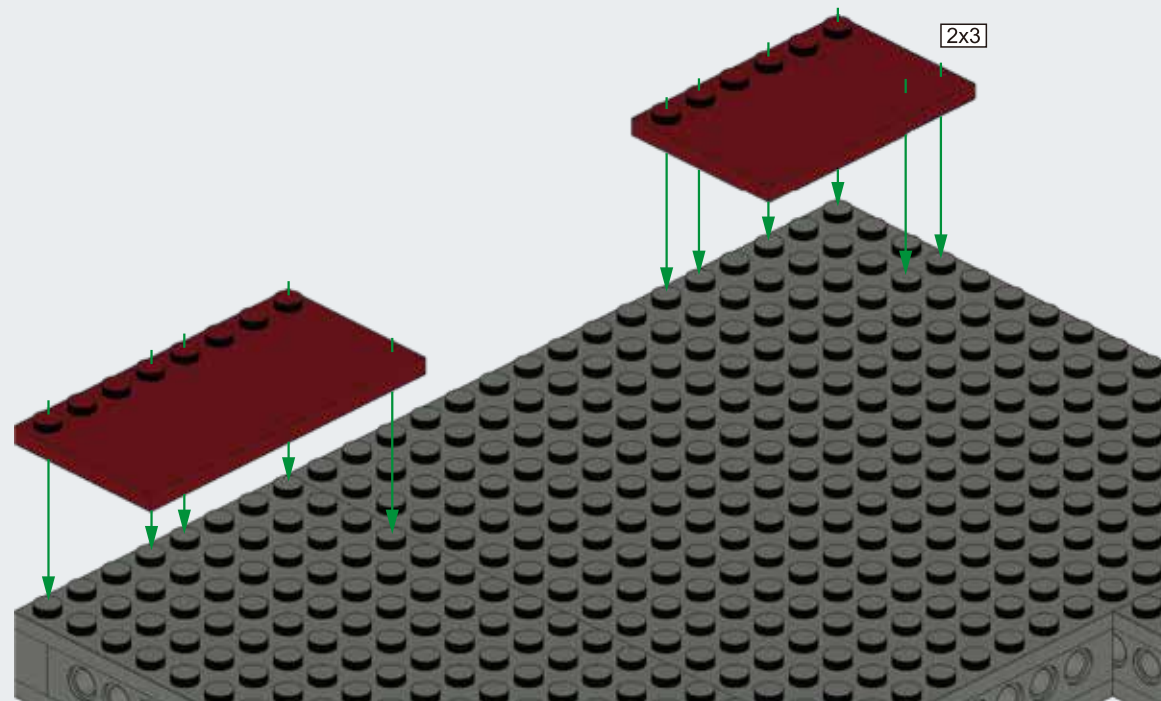

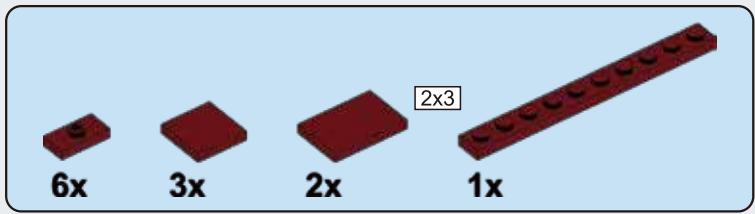

## A12

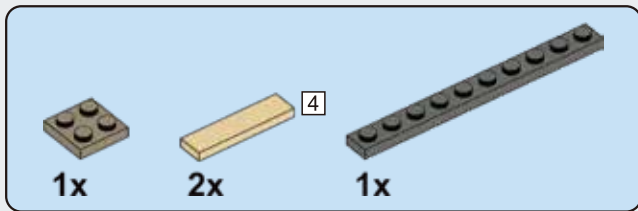
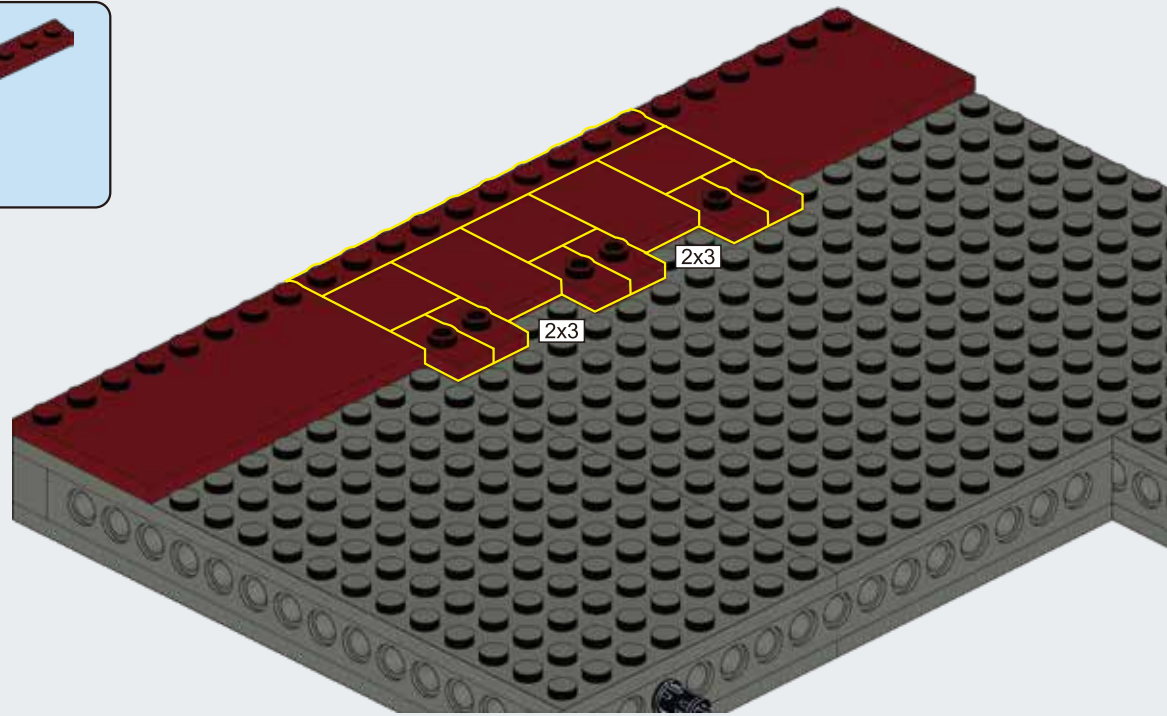

## A13

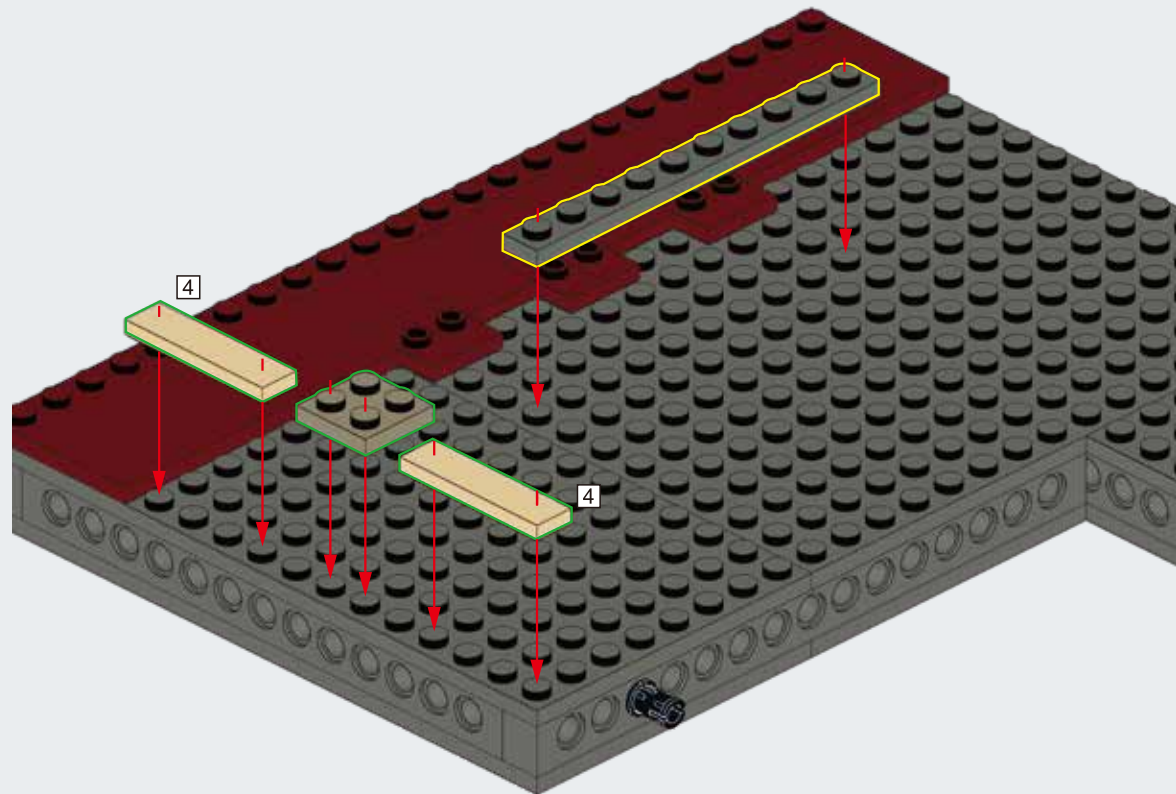

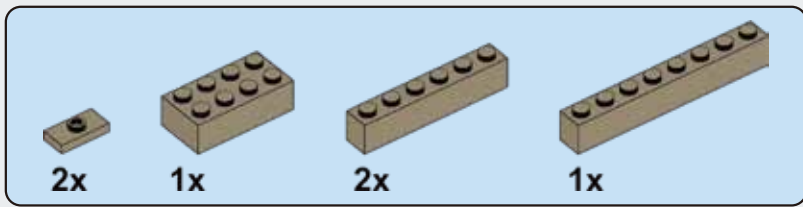

## A14

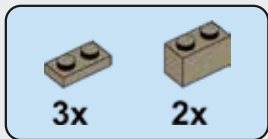
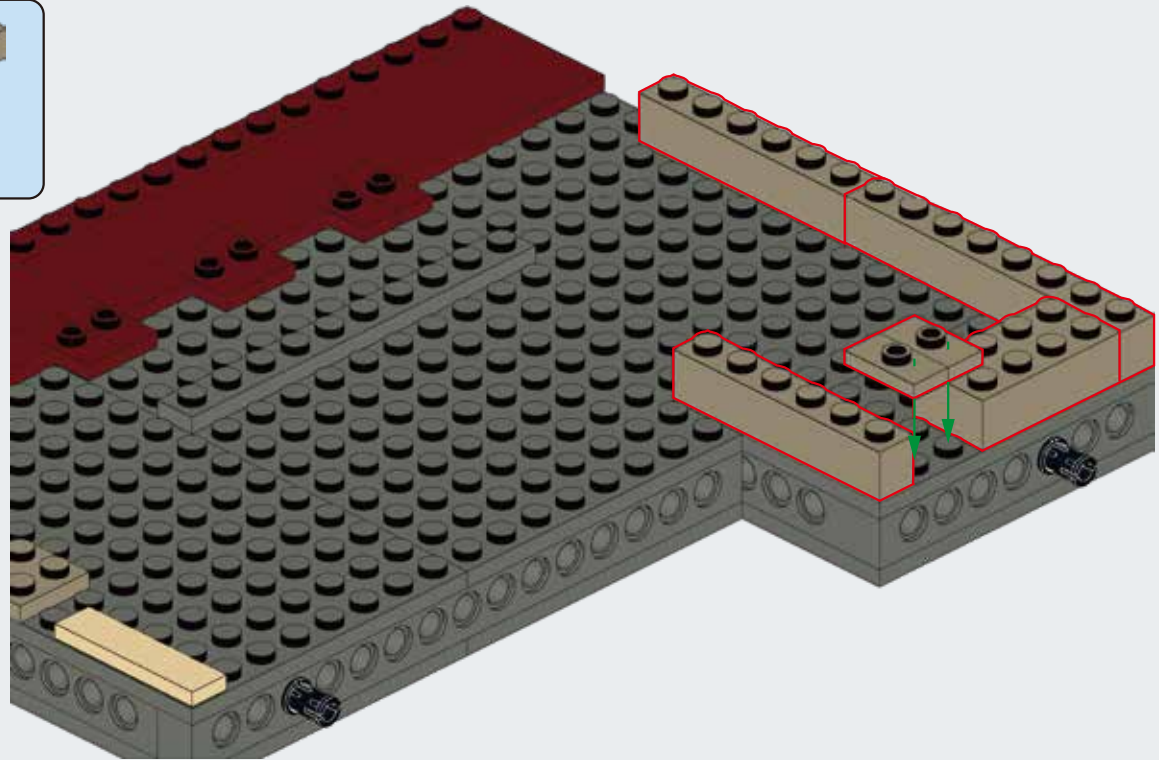

## A15

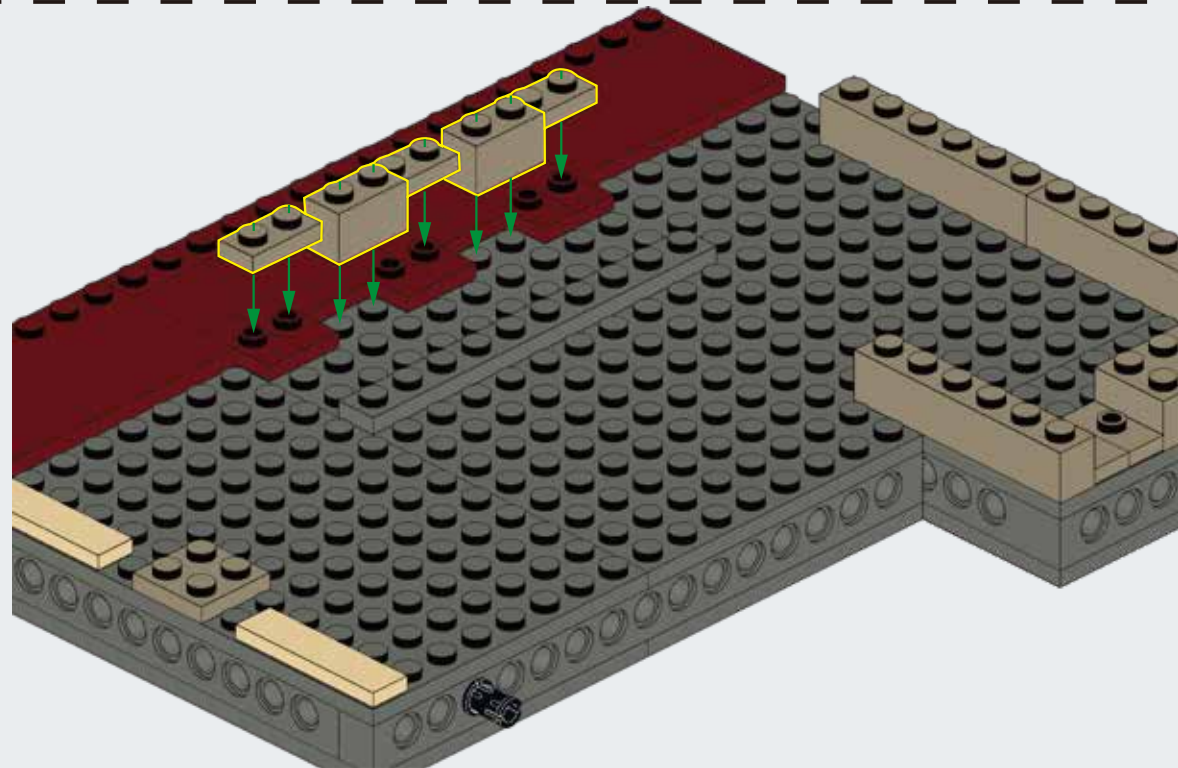

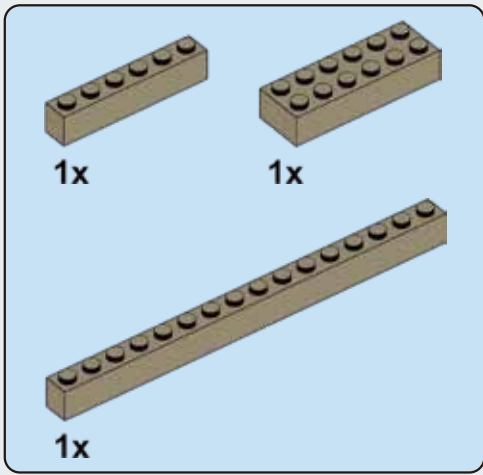

## A16

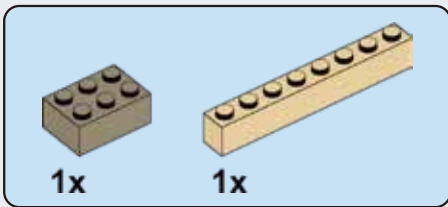
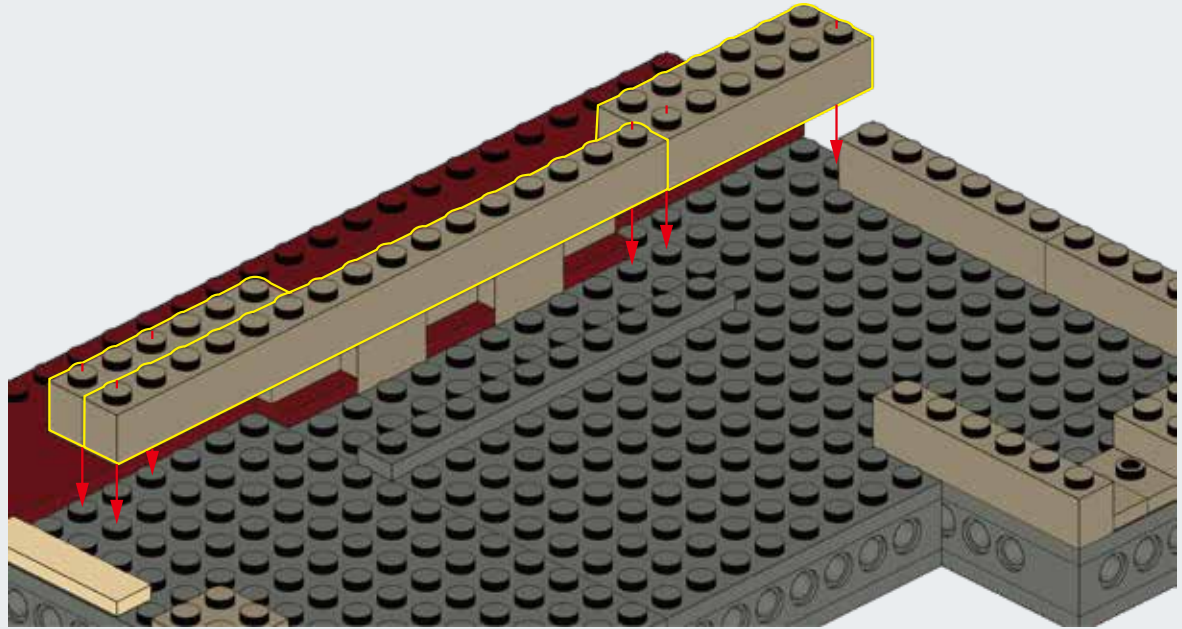

## A17

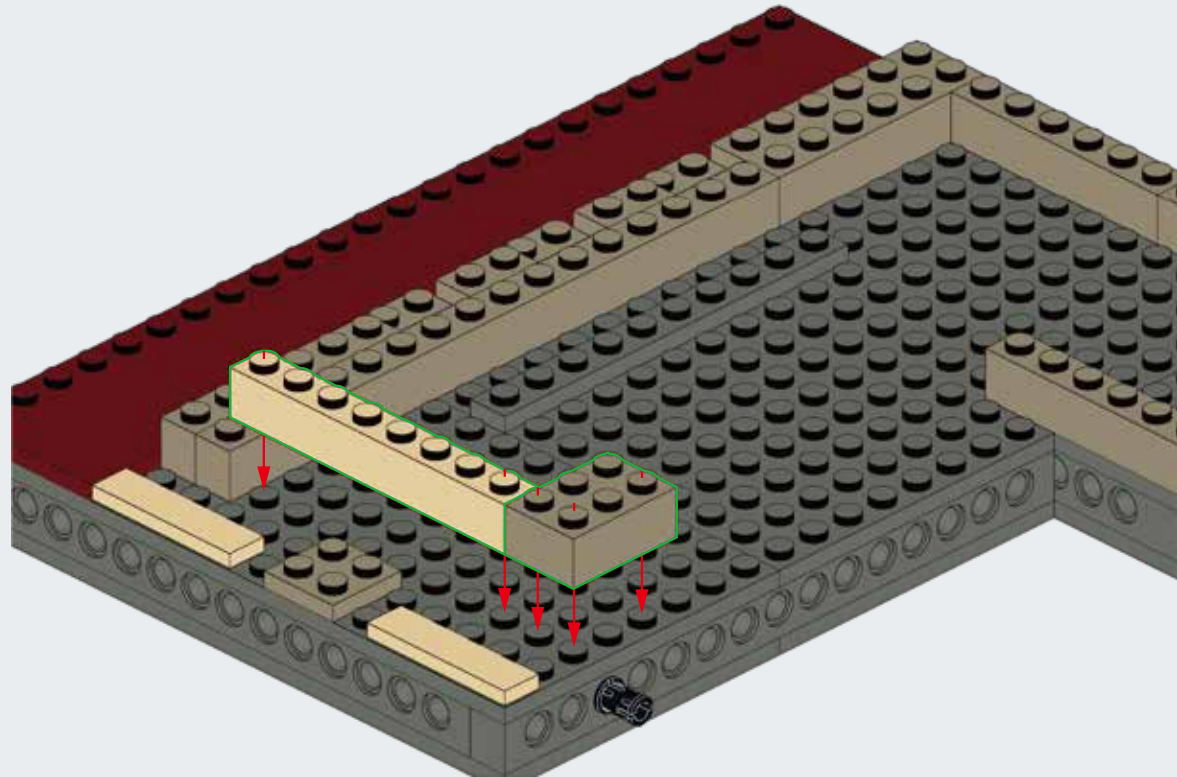

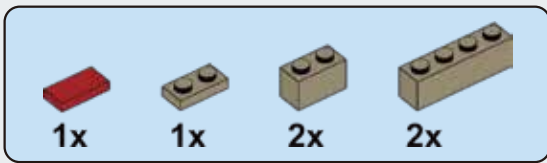

## A18

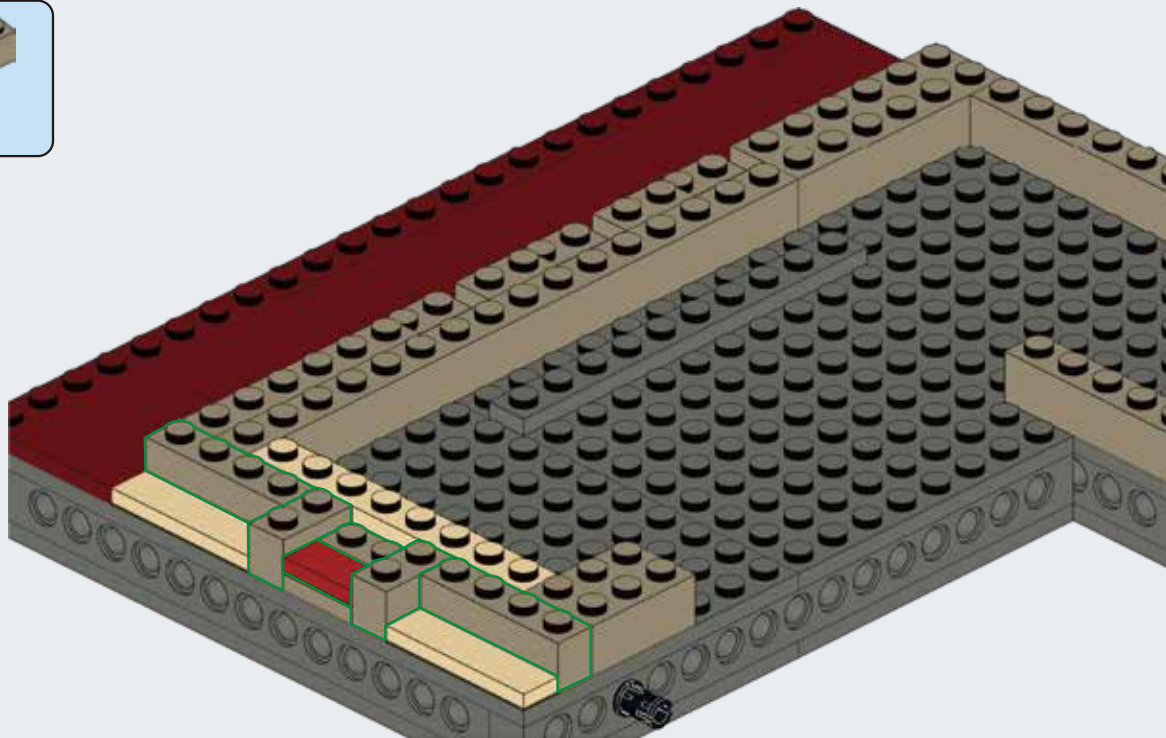

## A19

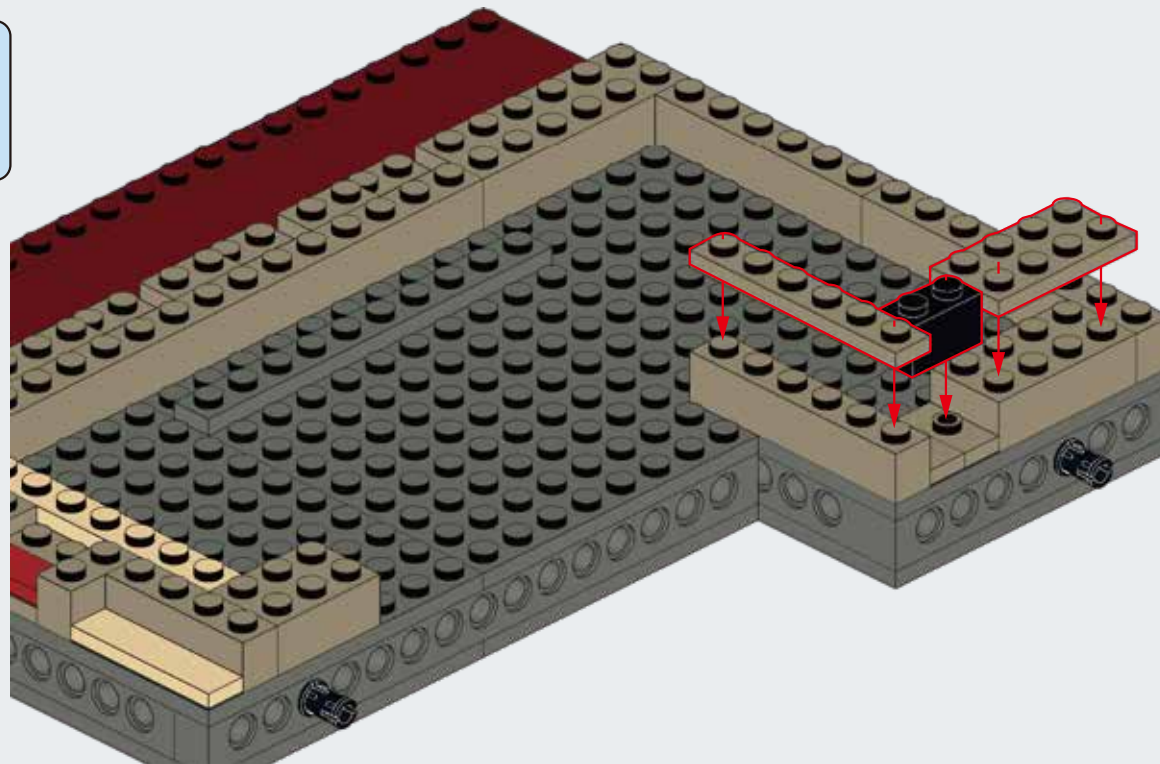

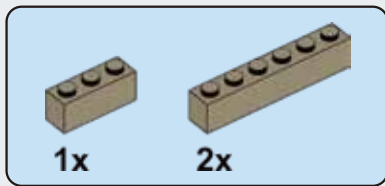

## A20

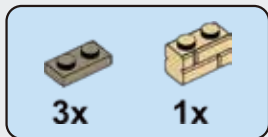
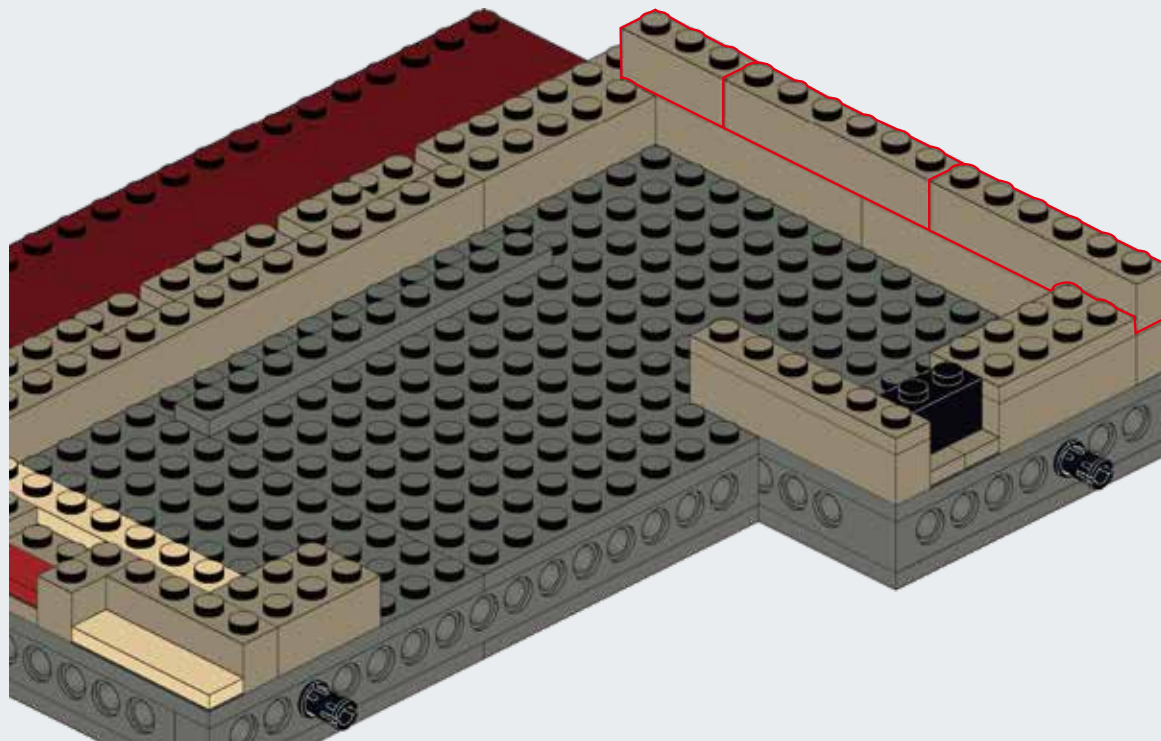

## A21

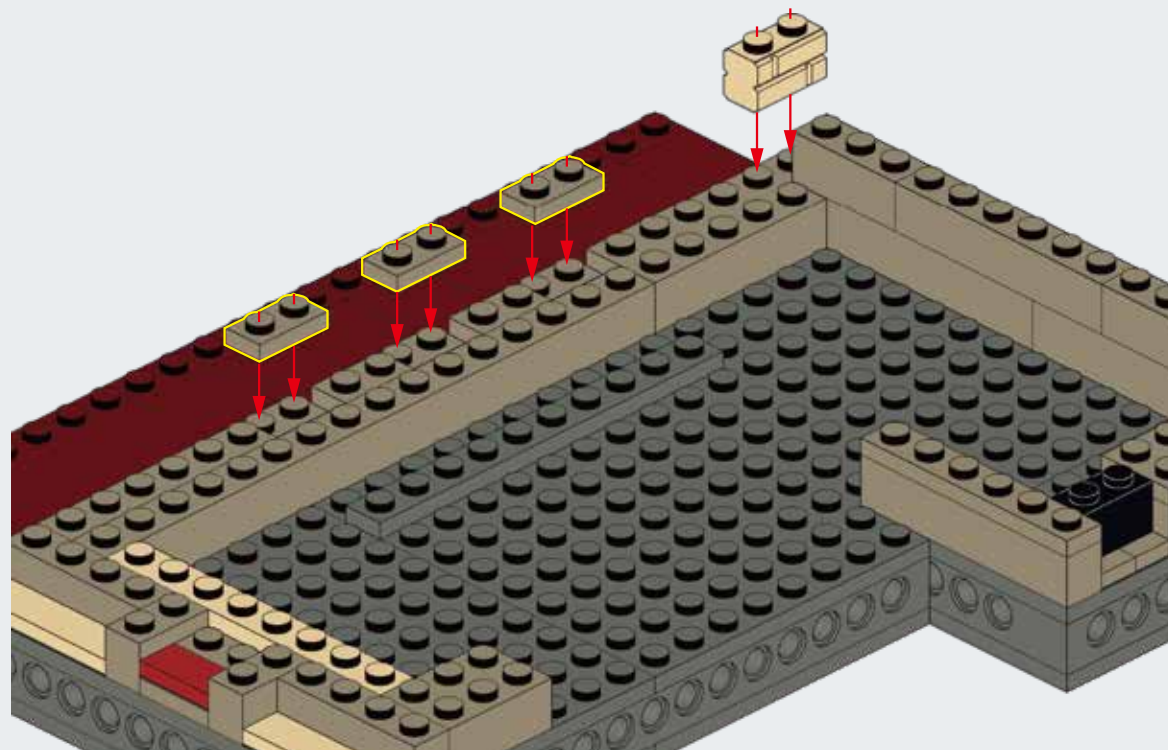





# A22

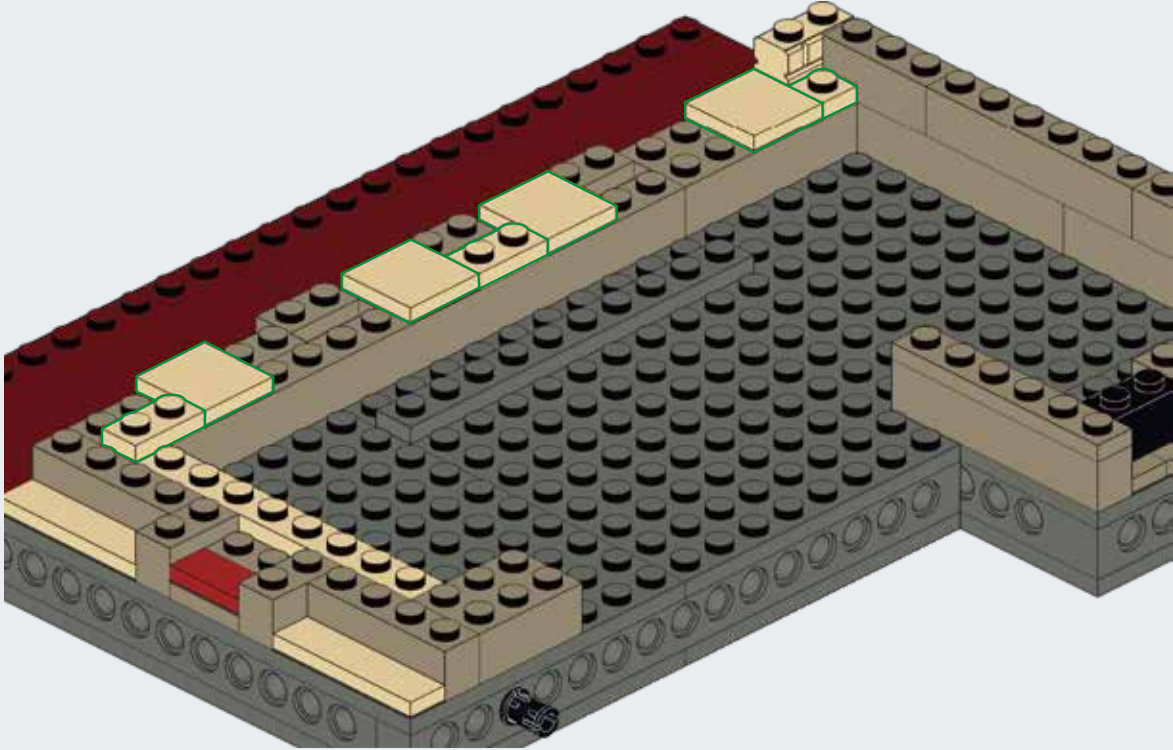

# A23

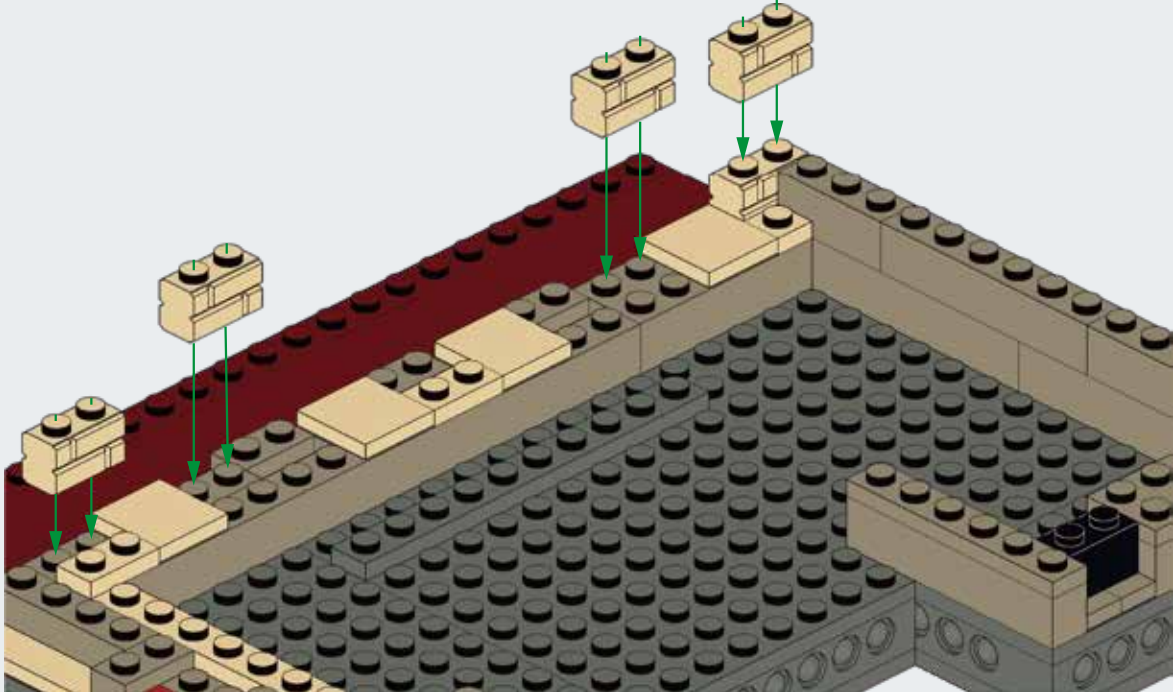

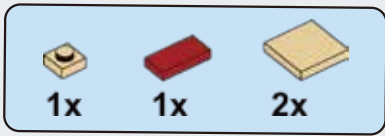

# A24

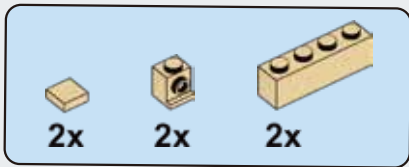
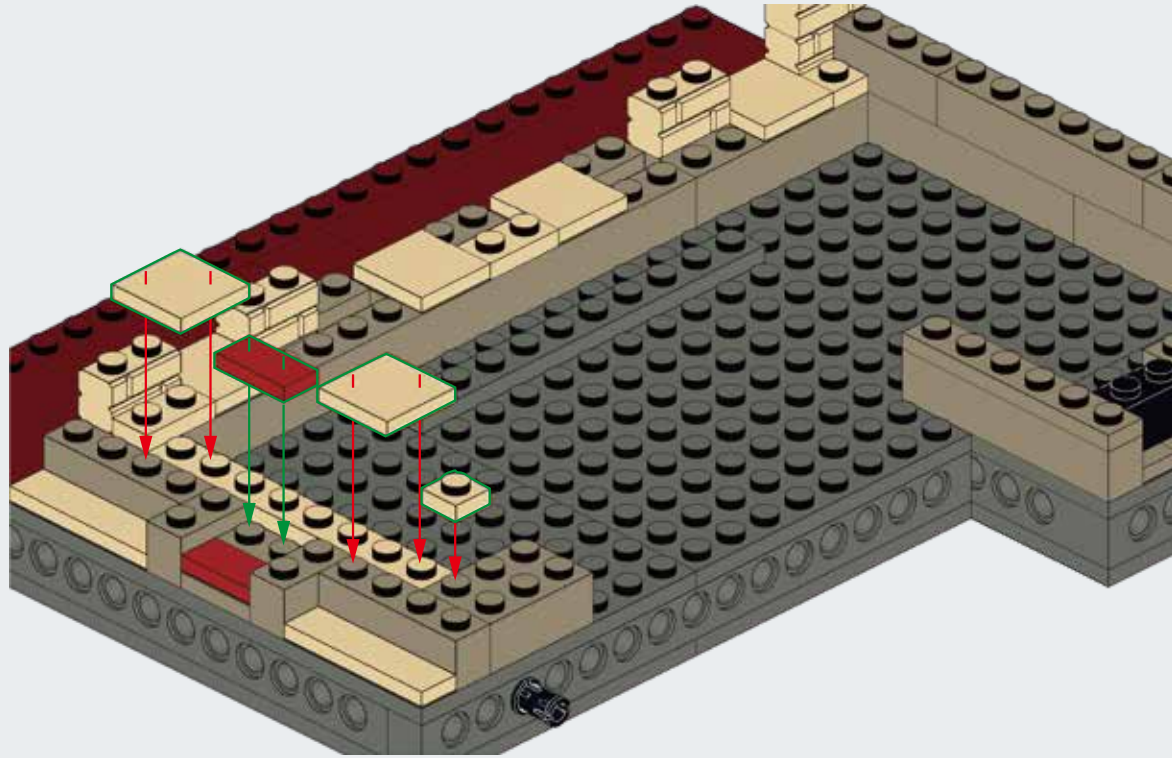

# A25

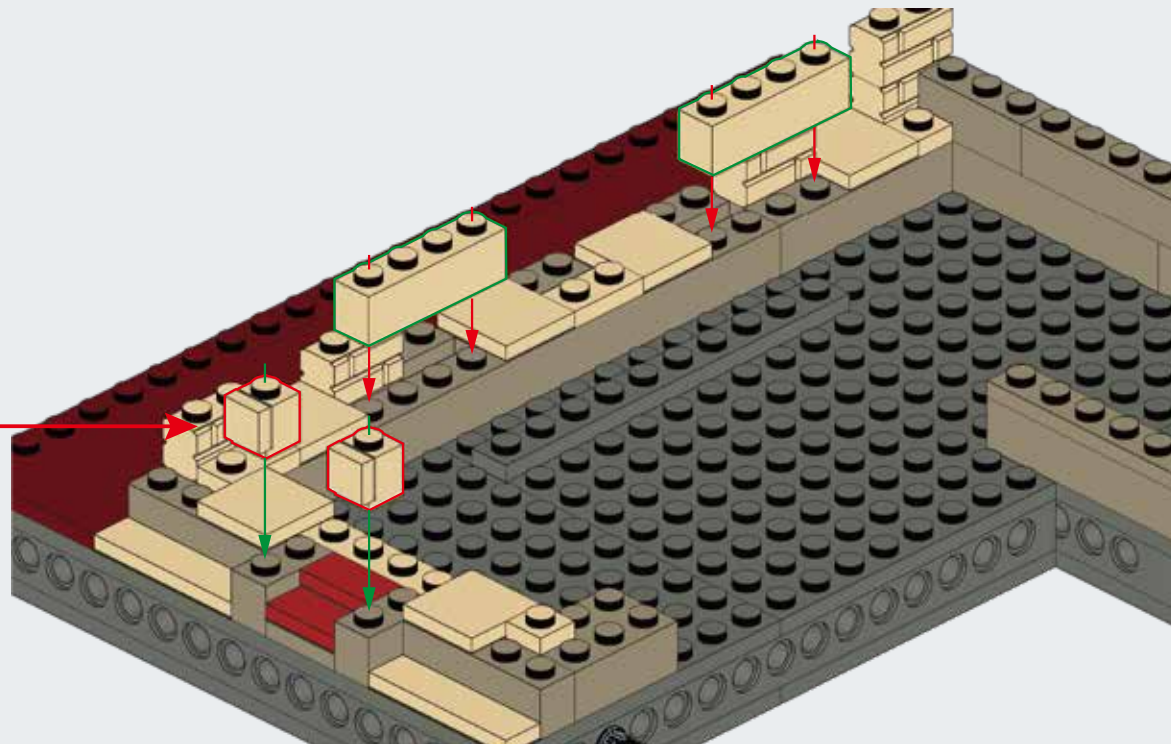
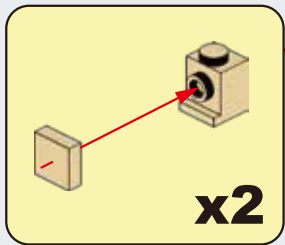

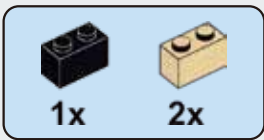

## A26

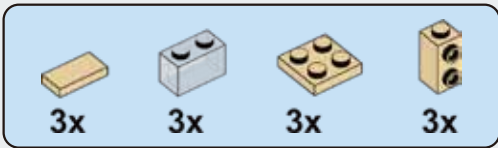
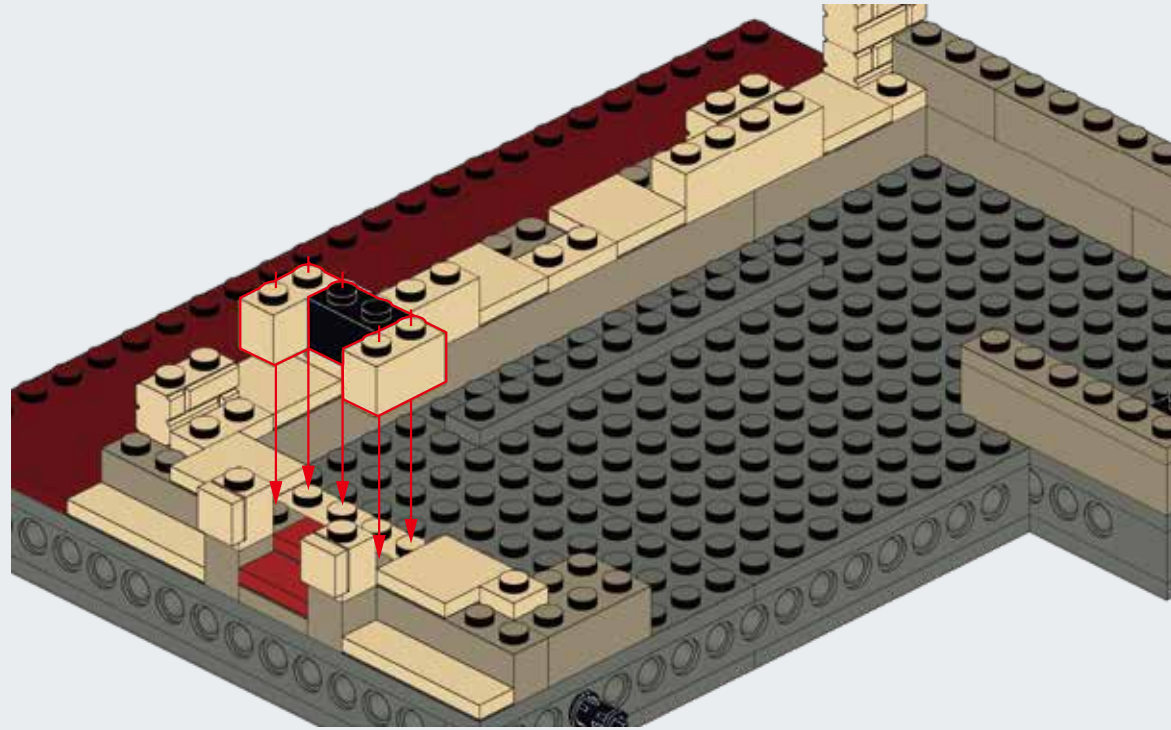

## A27

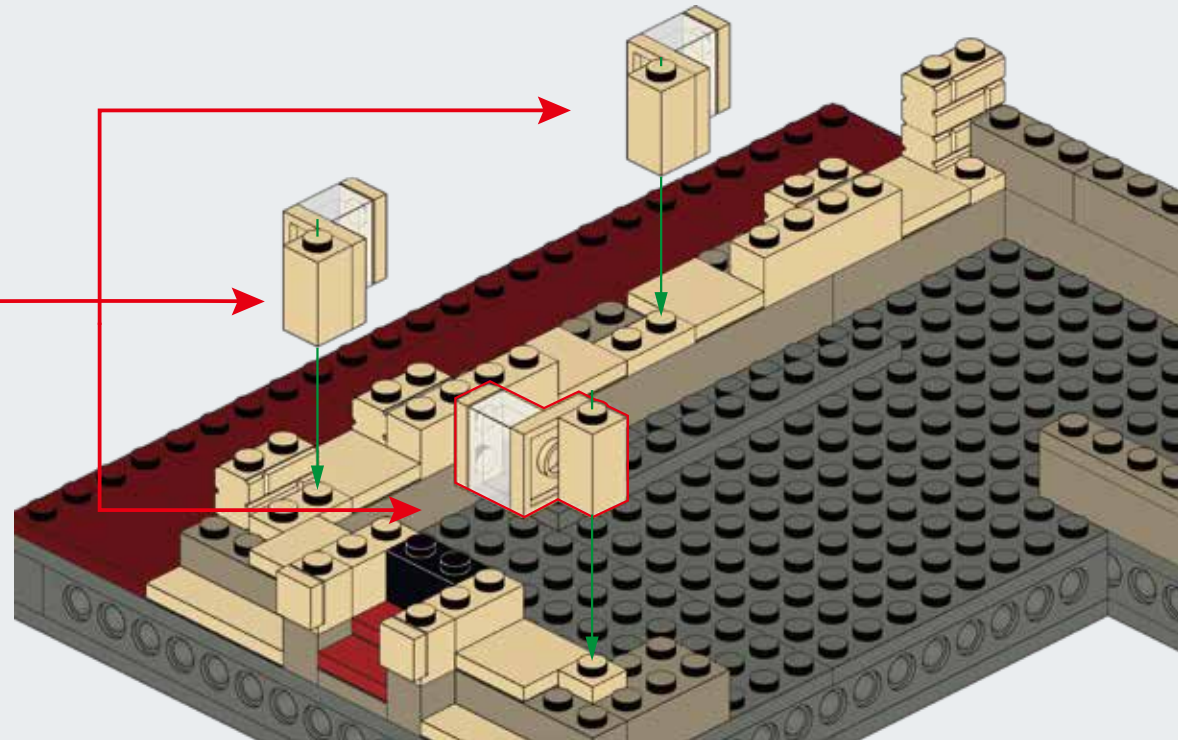
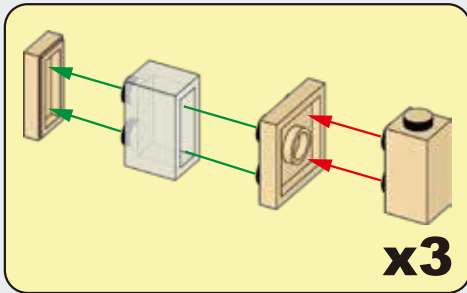

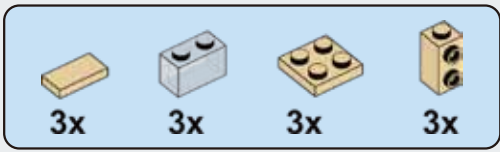

**A28**

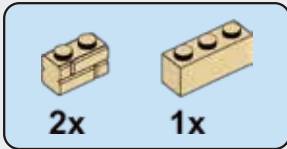
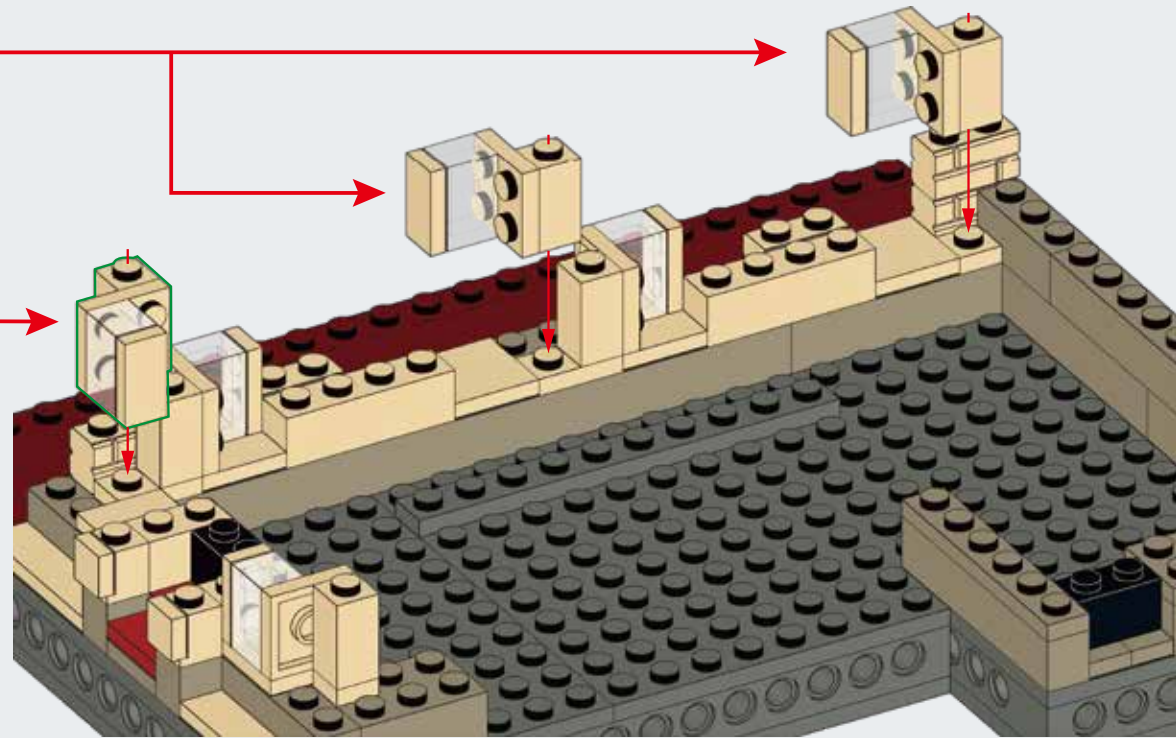
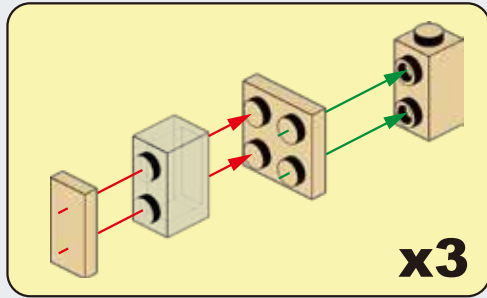

**A29**

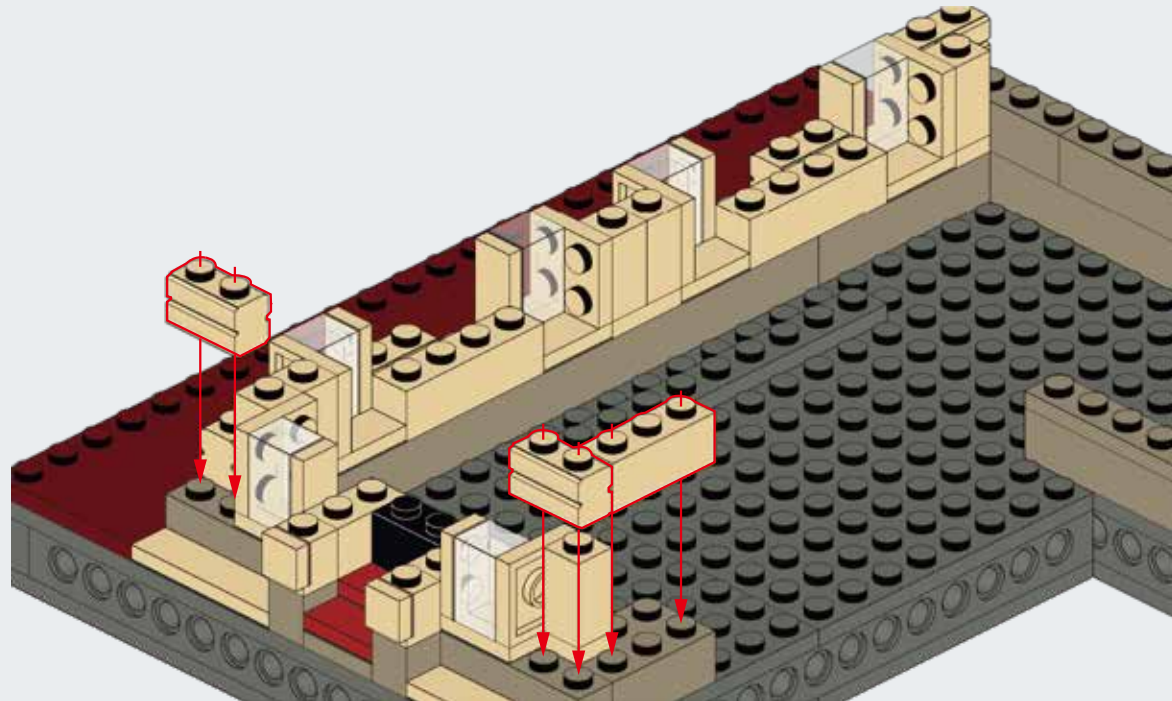

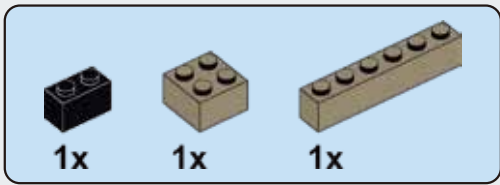

### A30

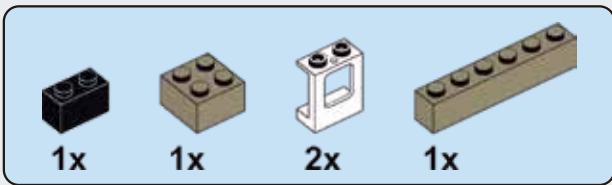
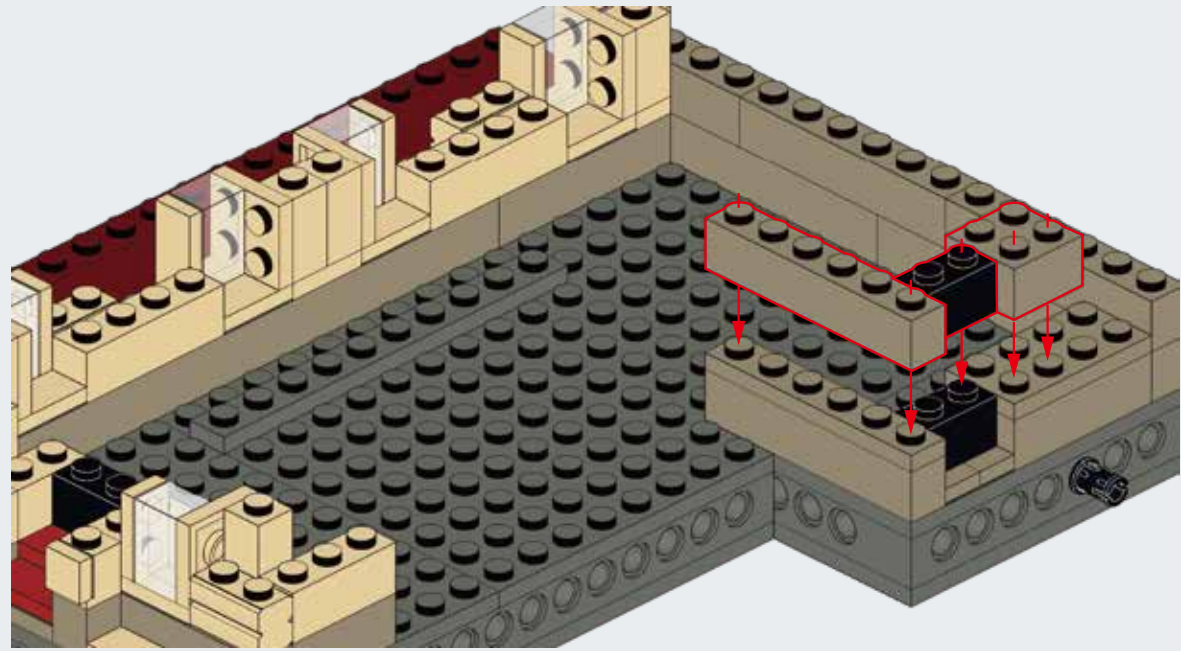

### A31

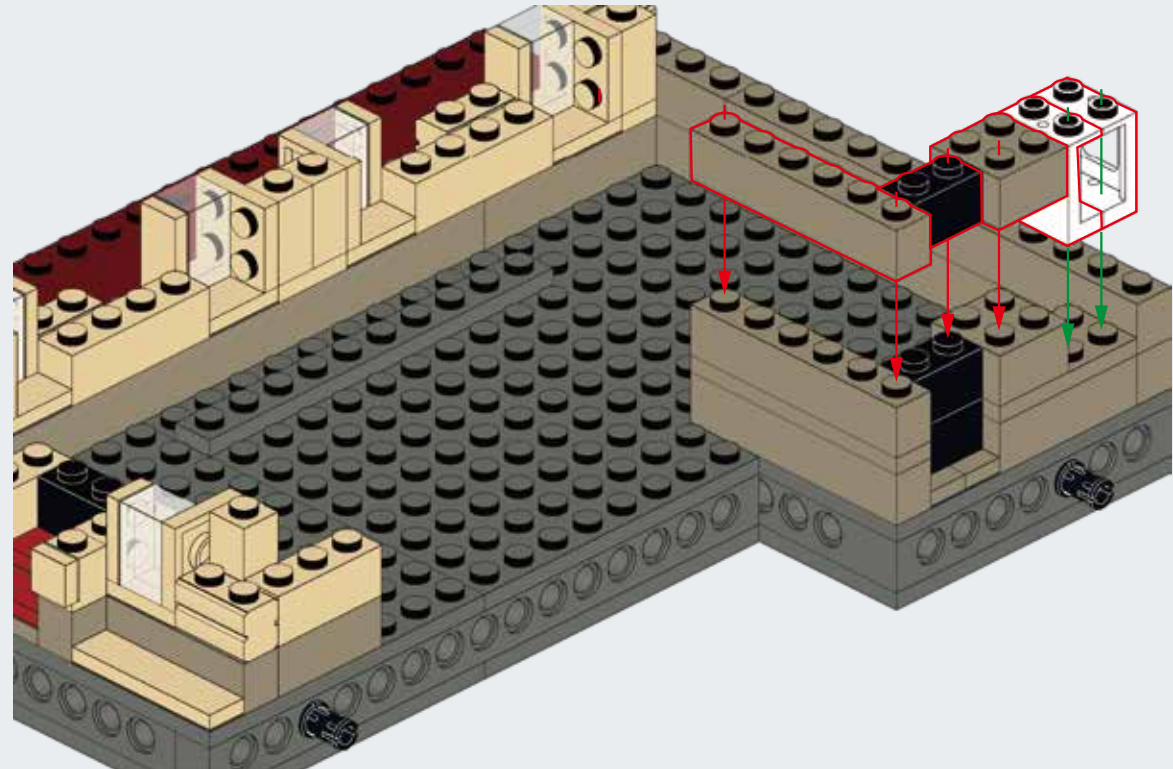

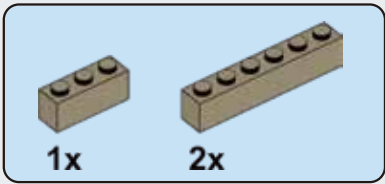

**A32**

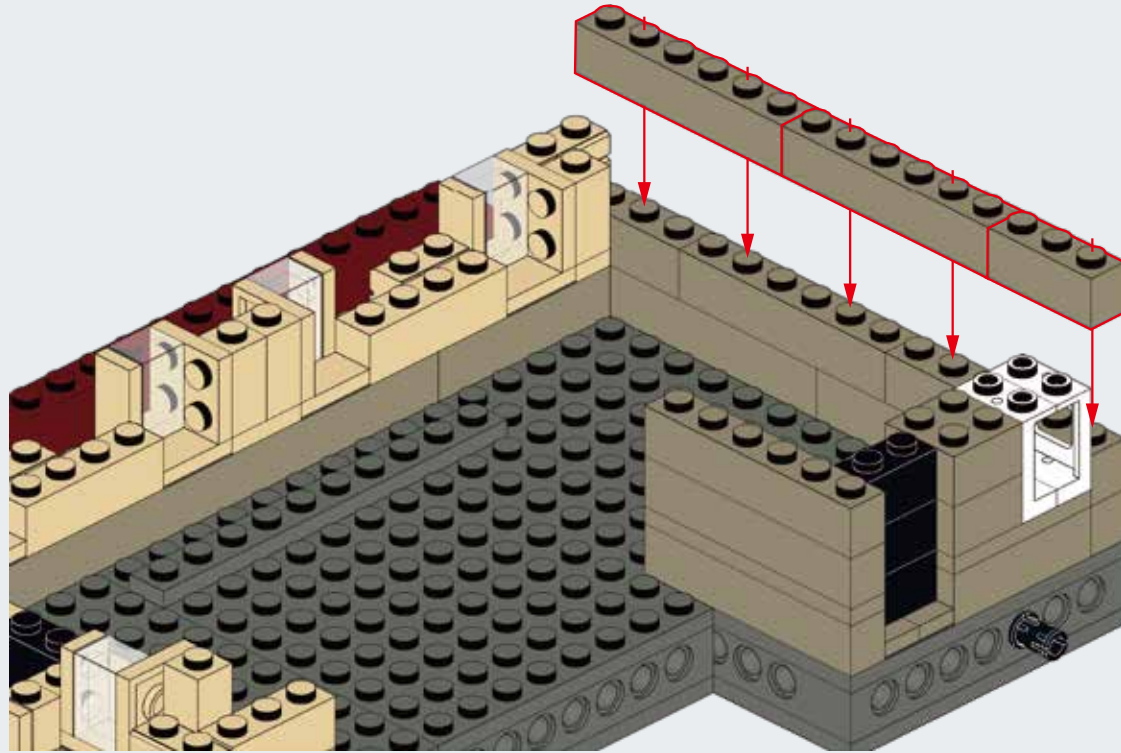

**A33**

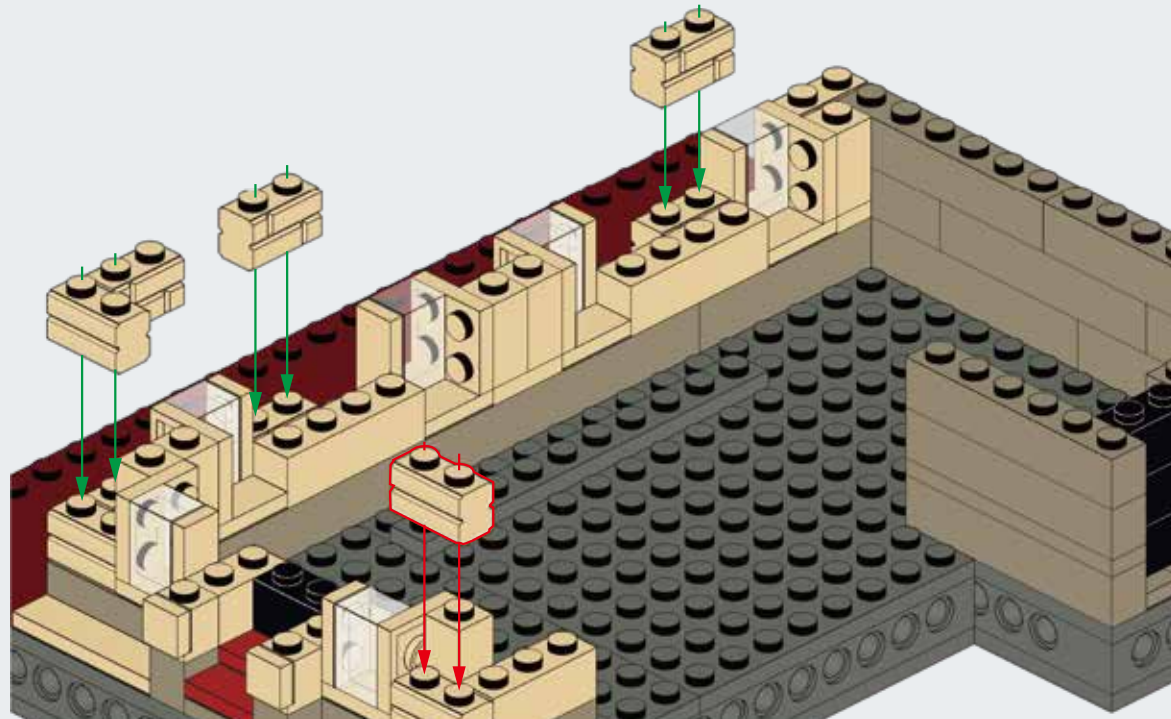

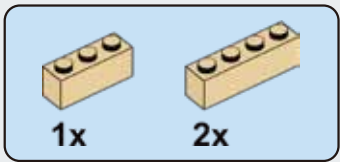

**A34**

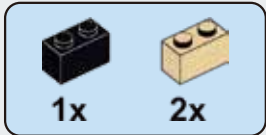
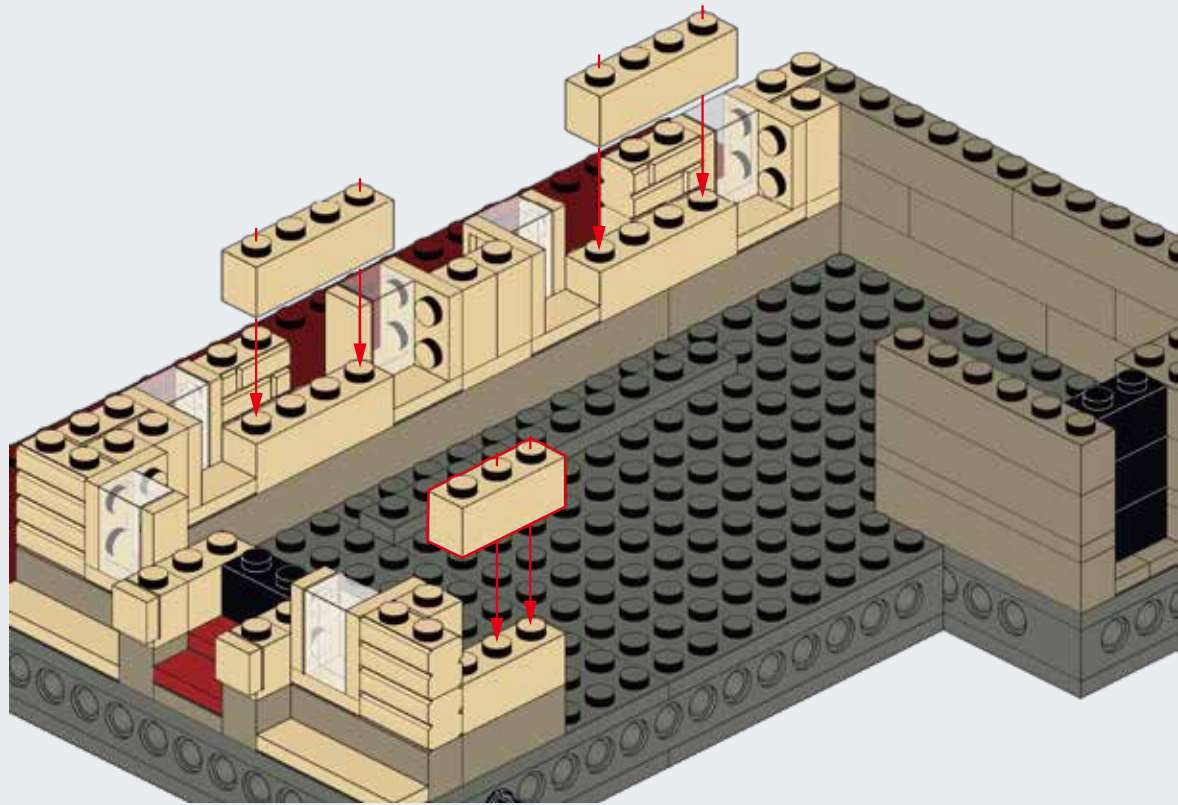

**A35**

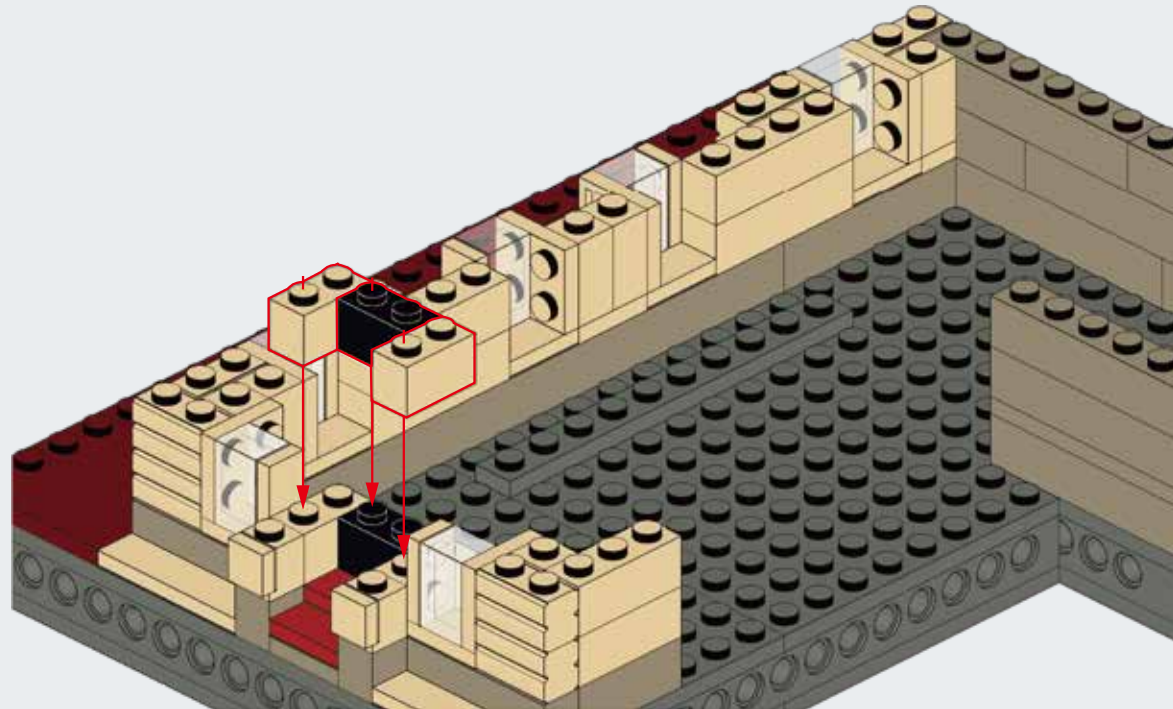

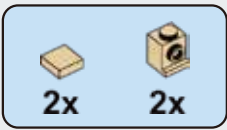

### A36

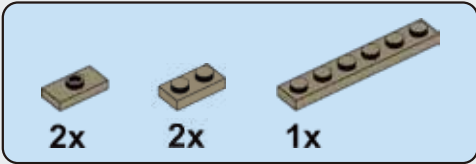
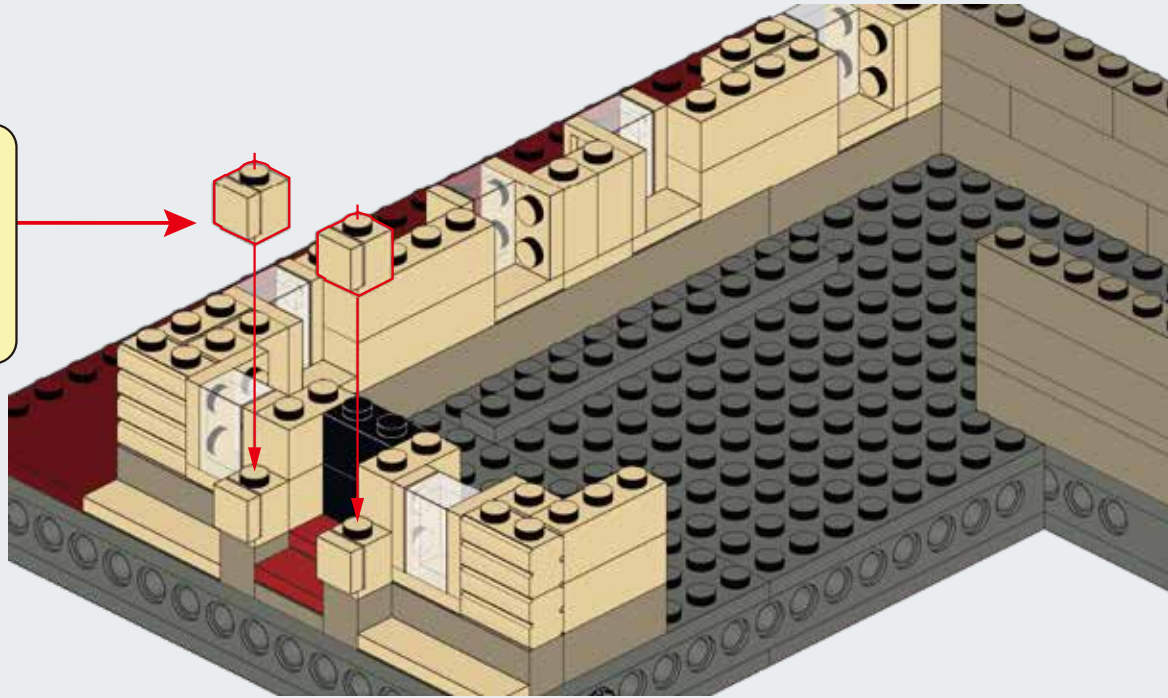
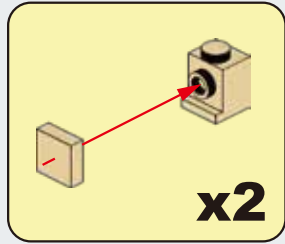

### A37

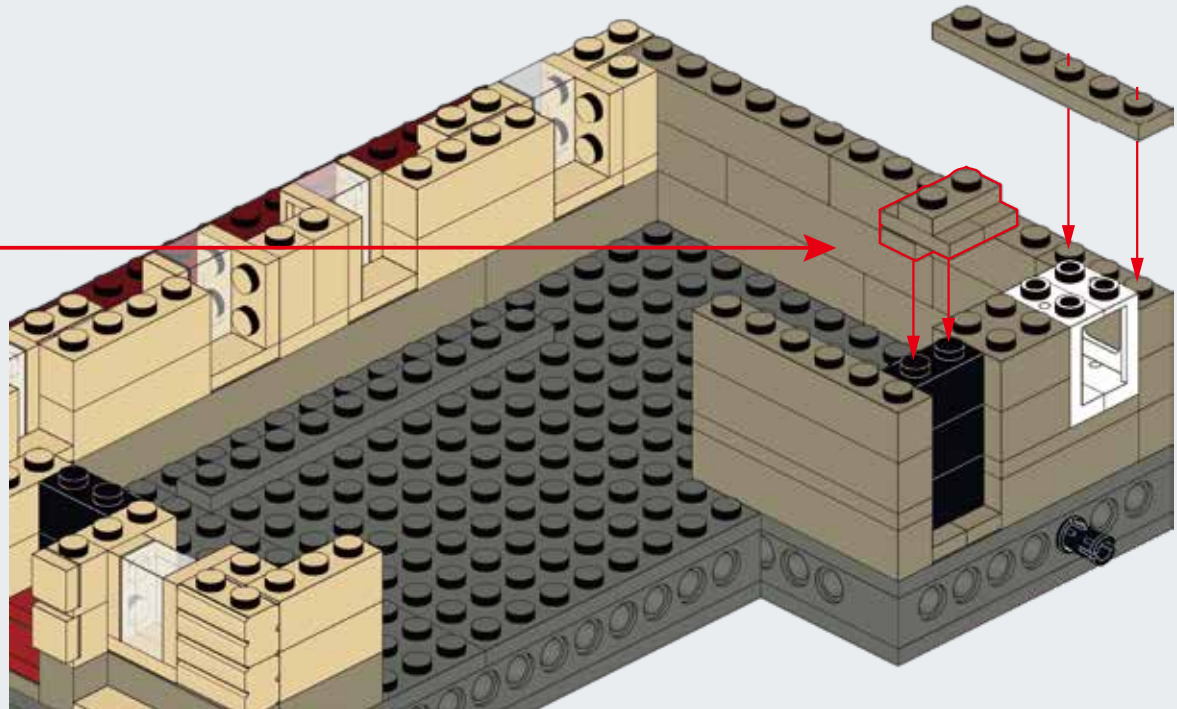
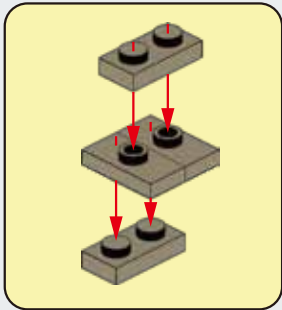



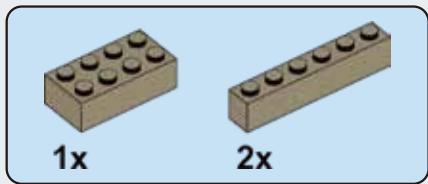

### A38

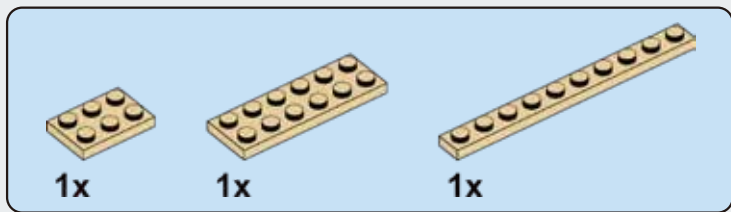
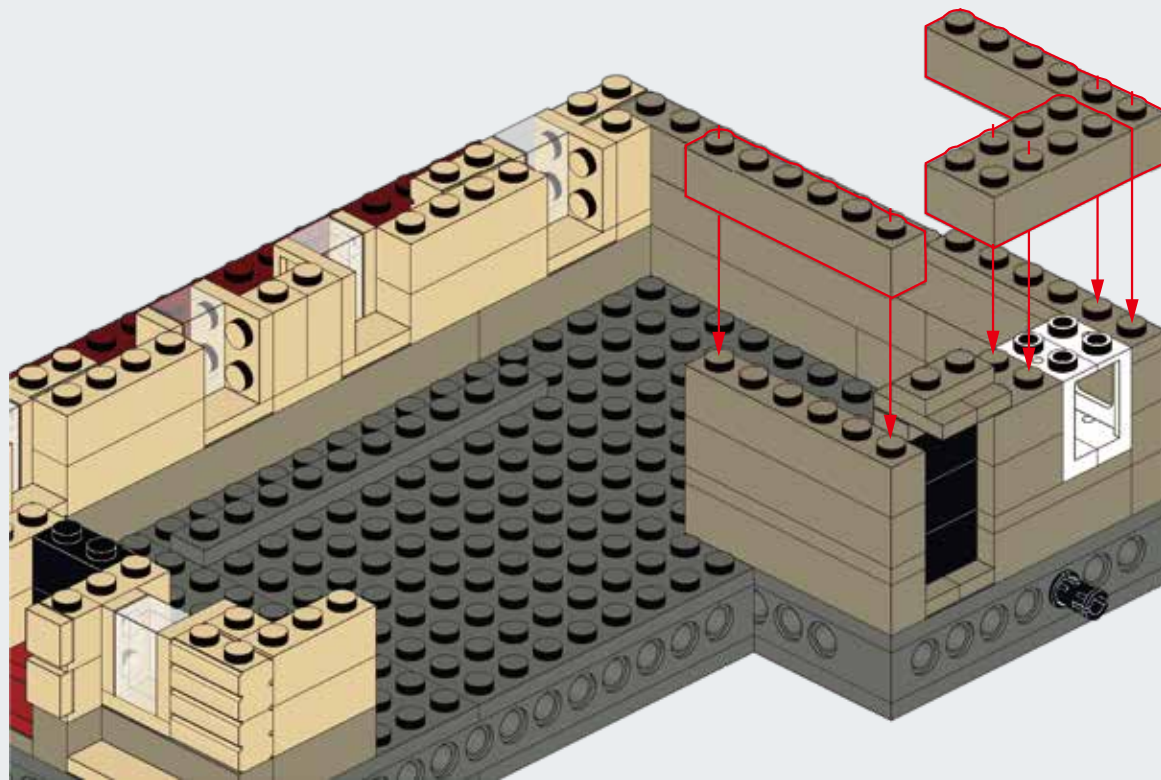

### A39

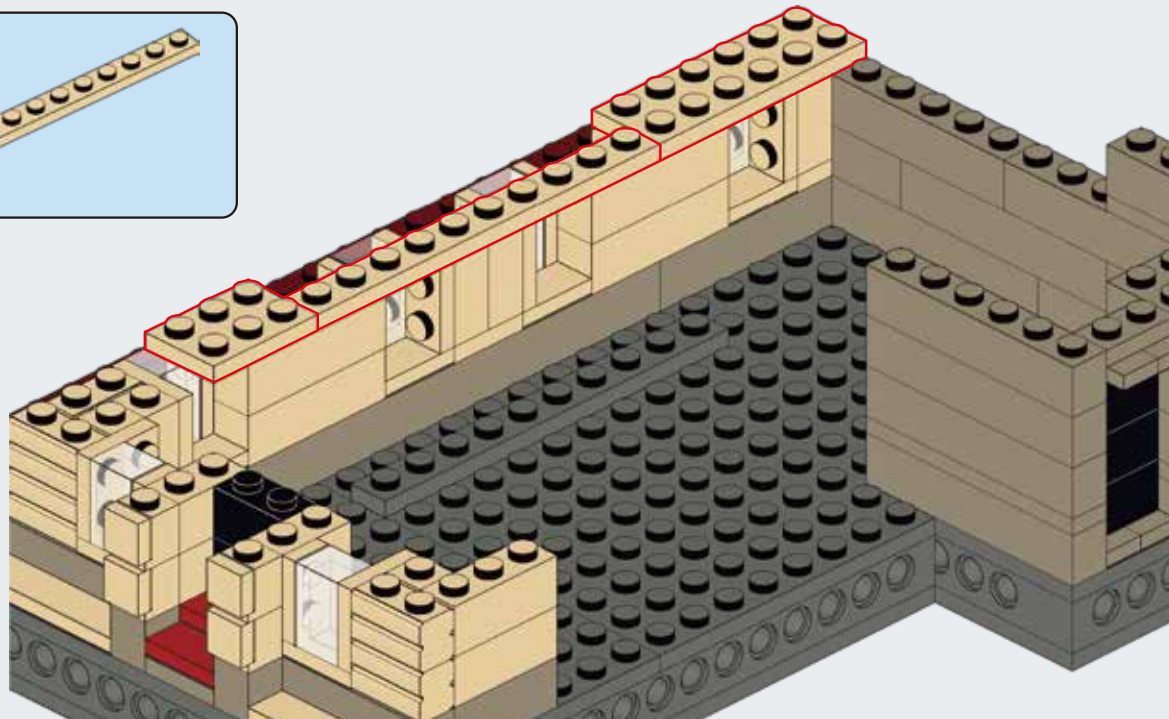

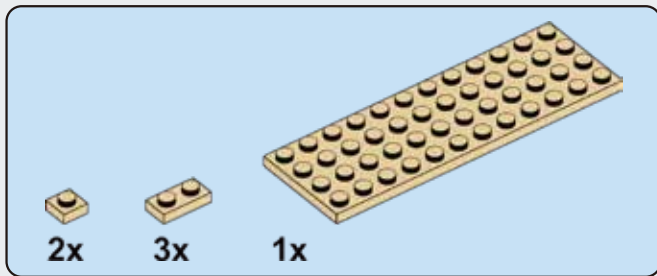

**A40**

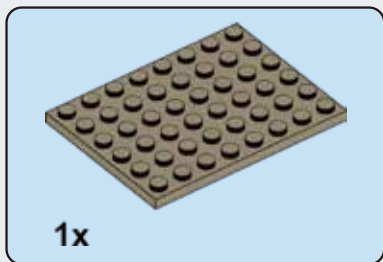
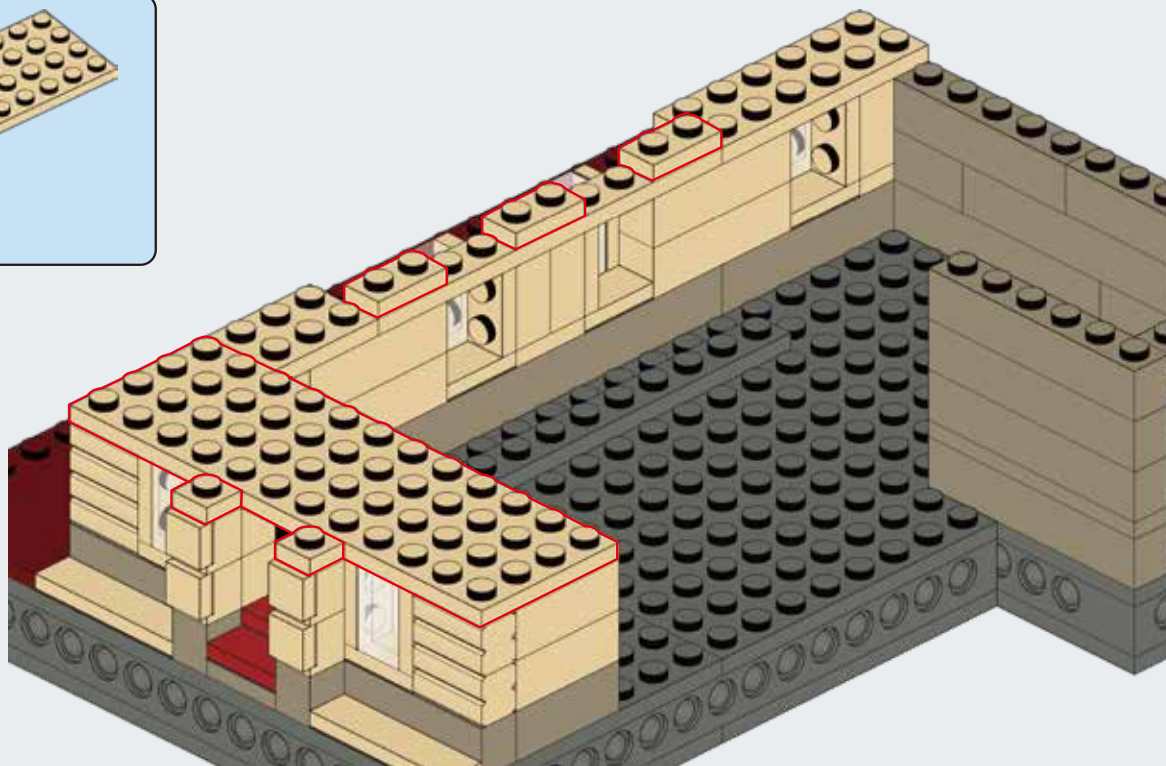

**A41**

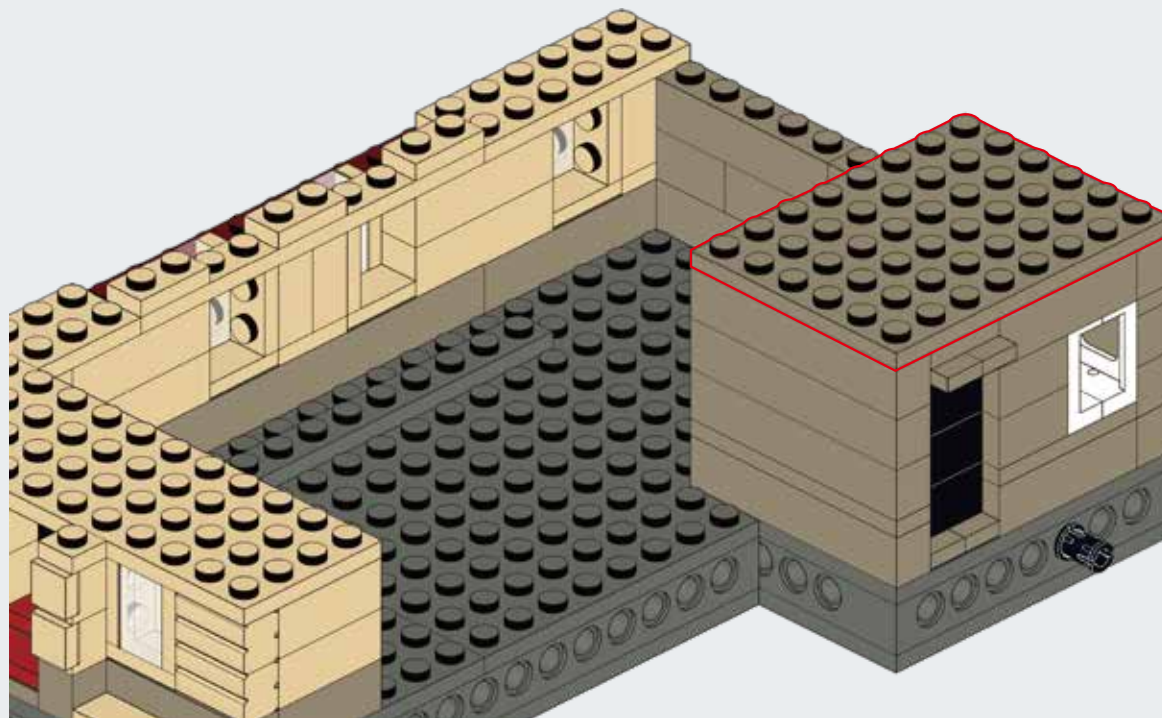



**A42**

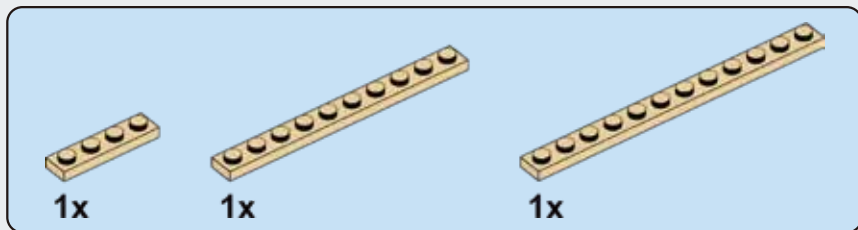
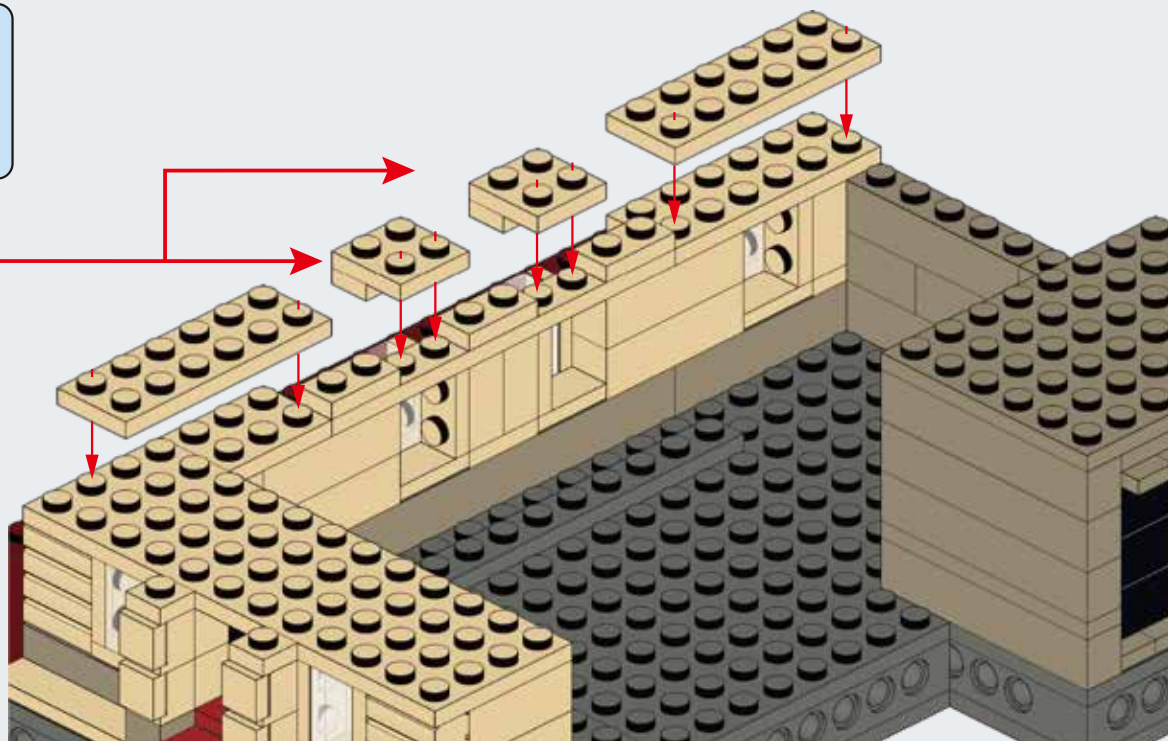
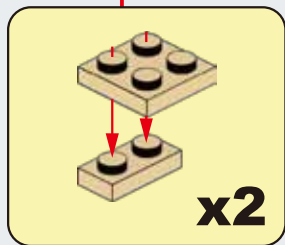

**A43**

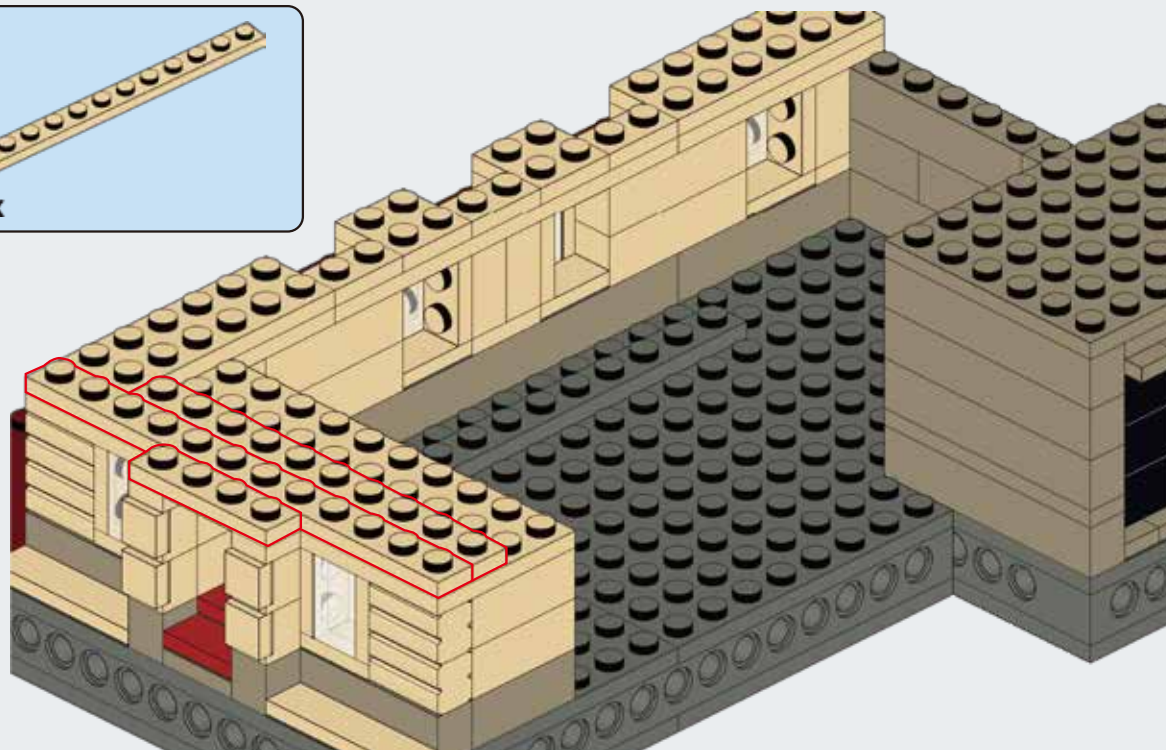



## A44

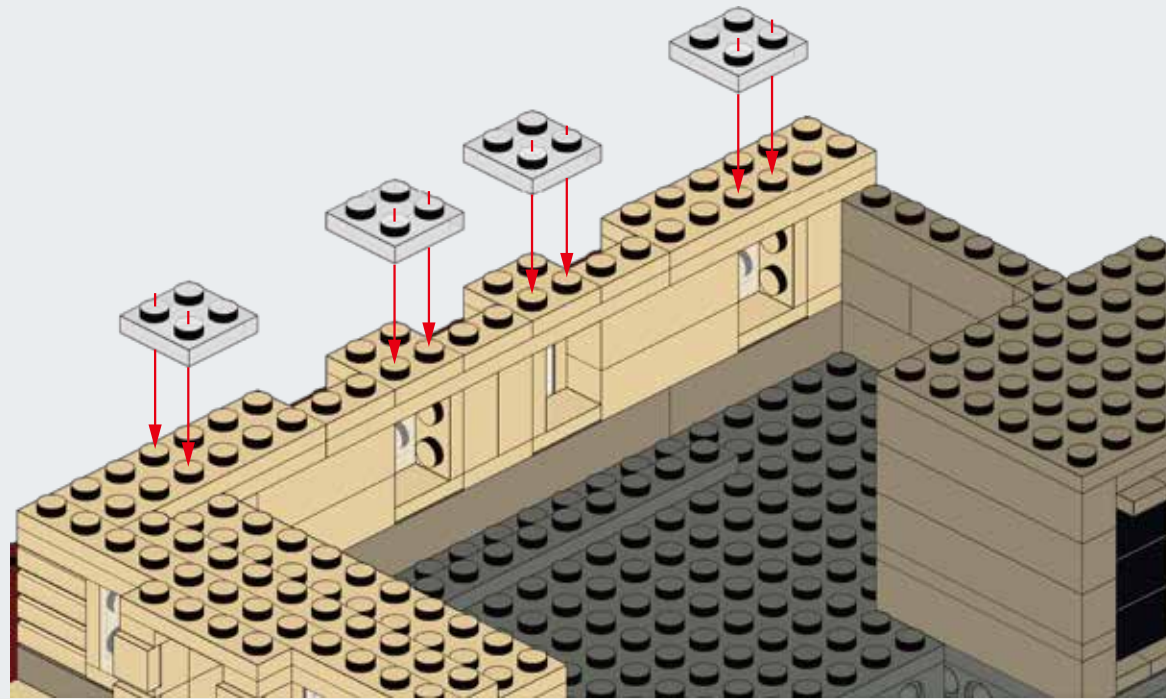

## A45

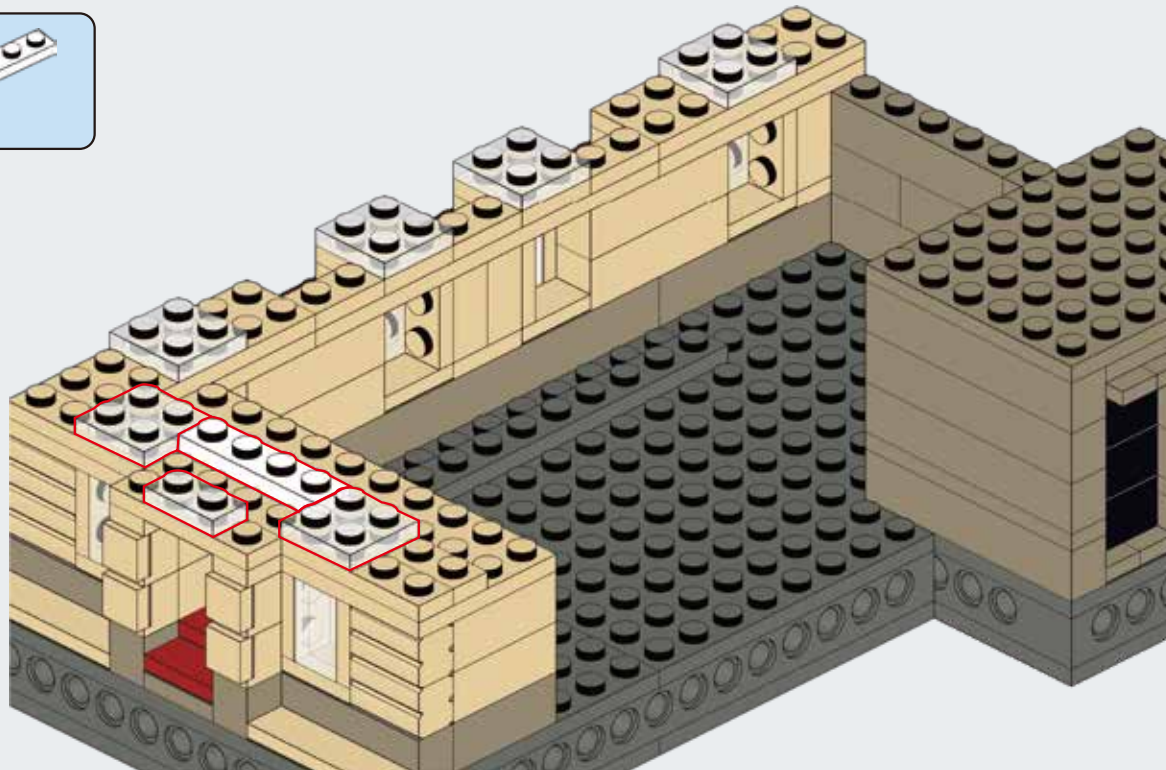



# A46

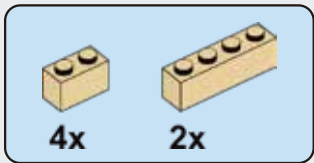
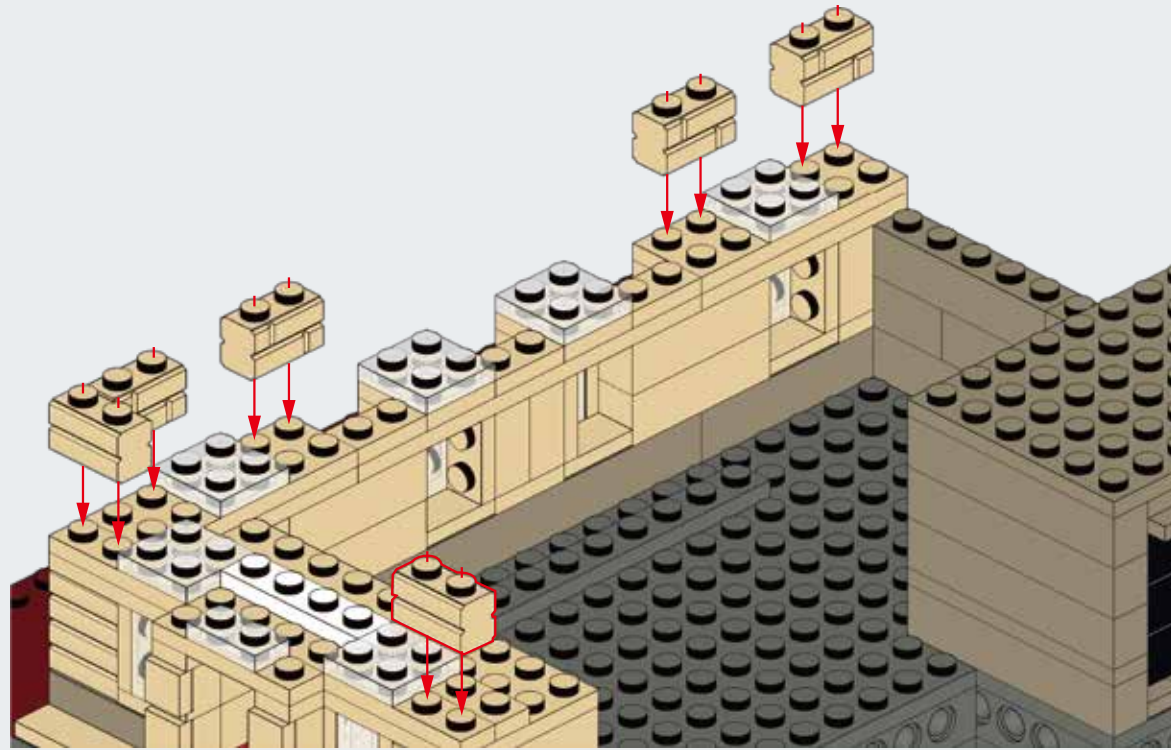

# A47

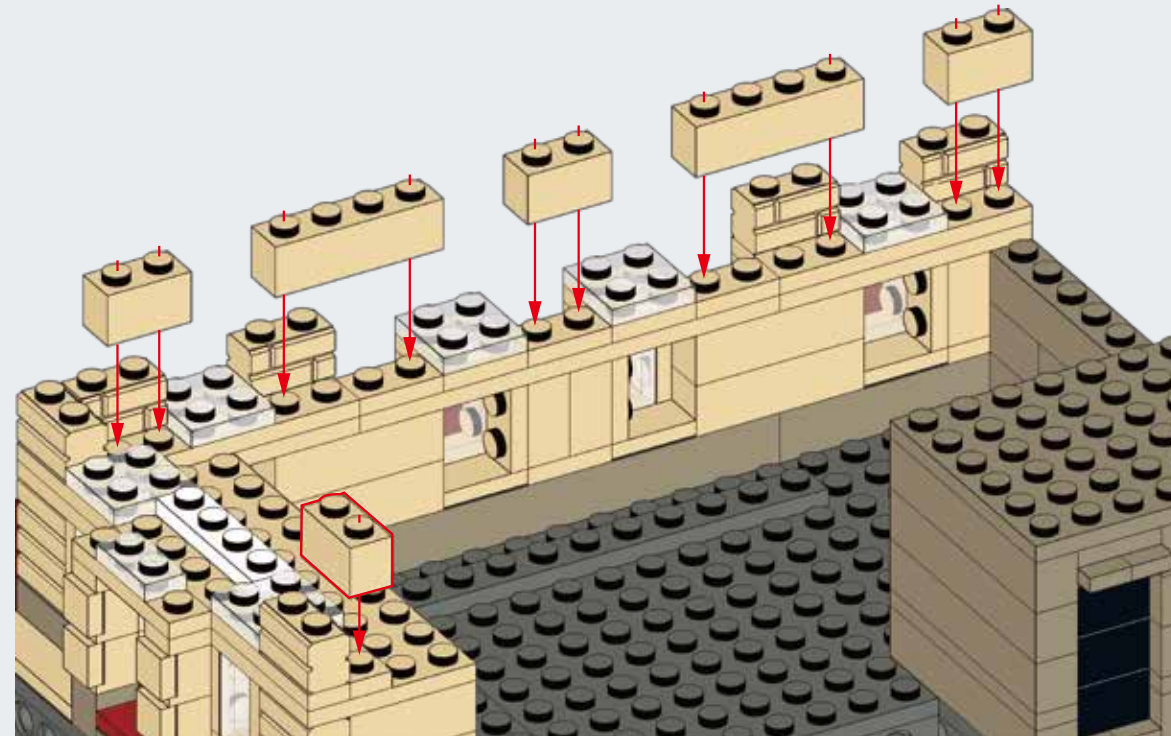

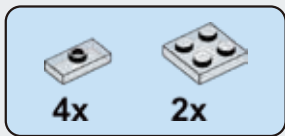

# A48

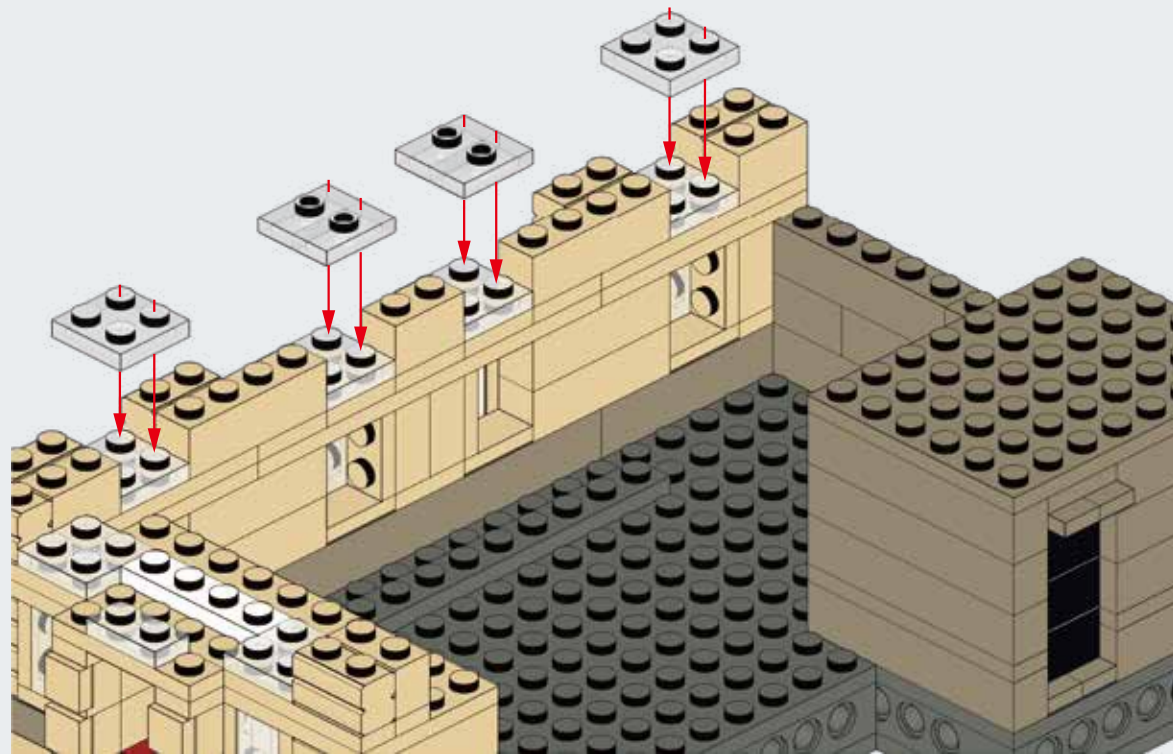

# A49

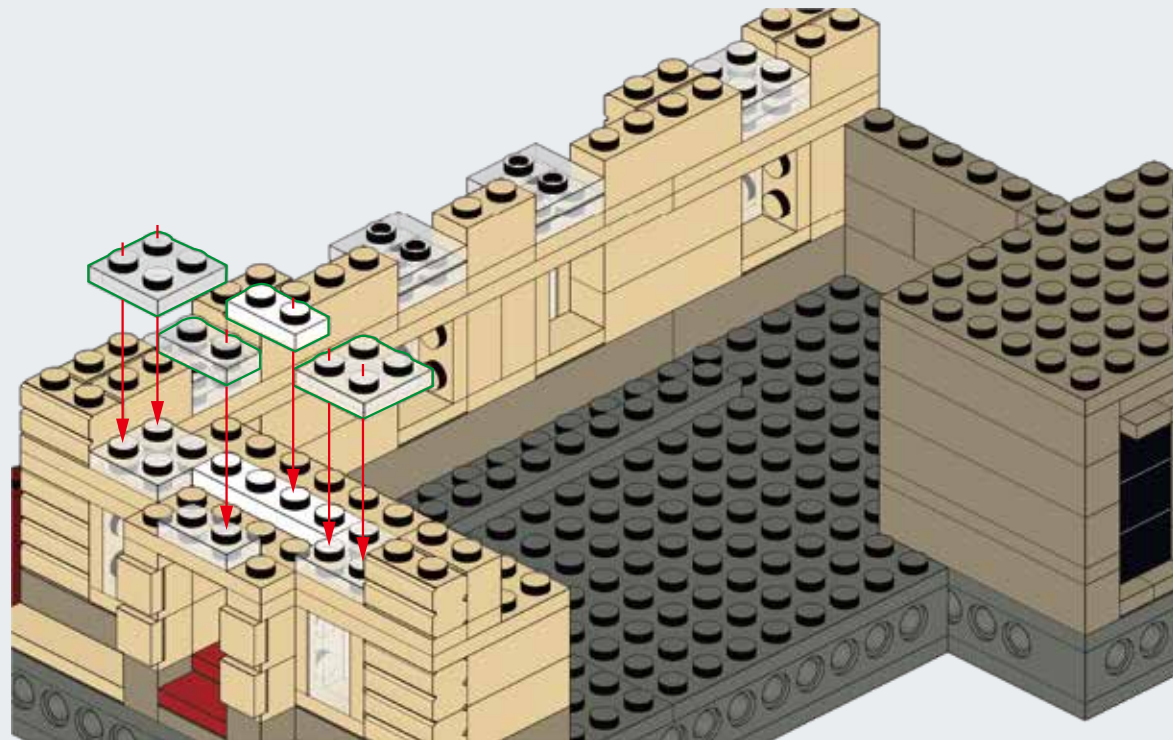

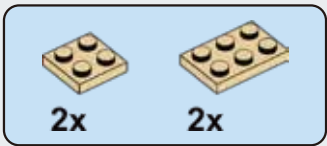

## A50

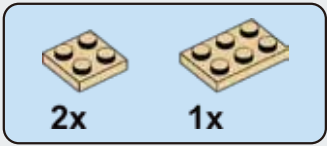
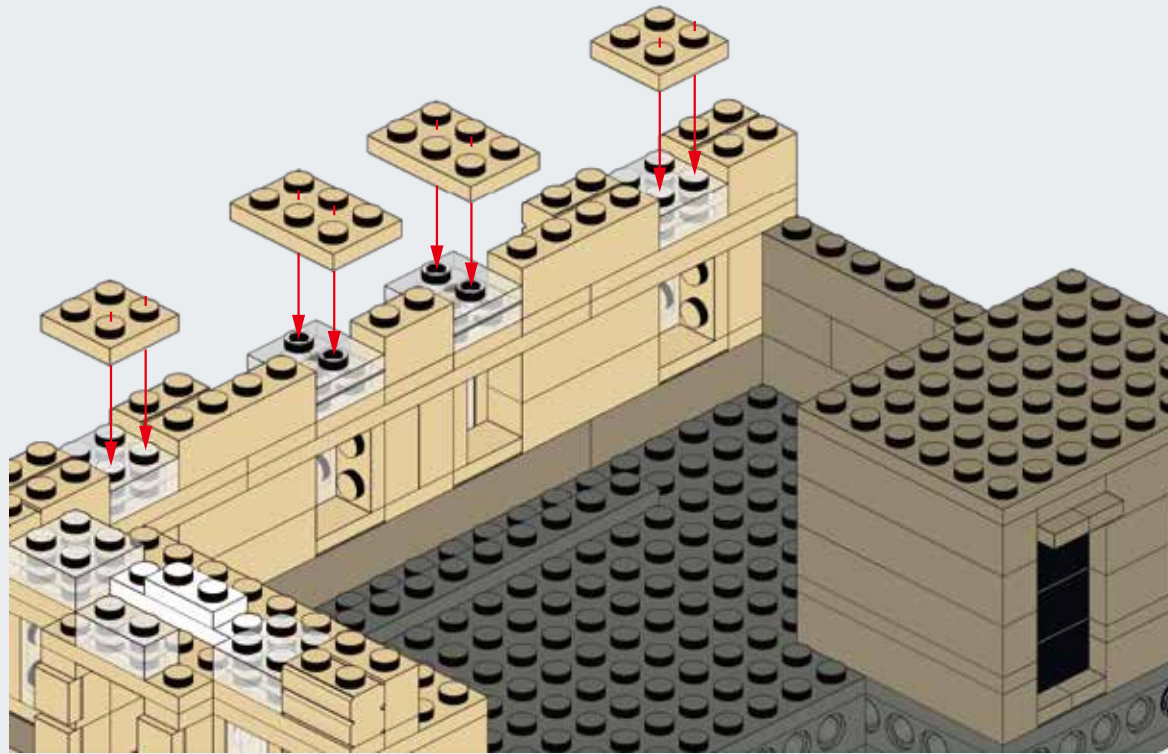

## A51

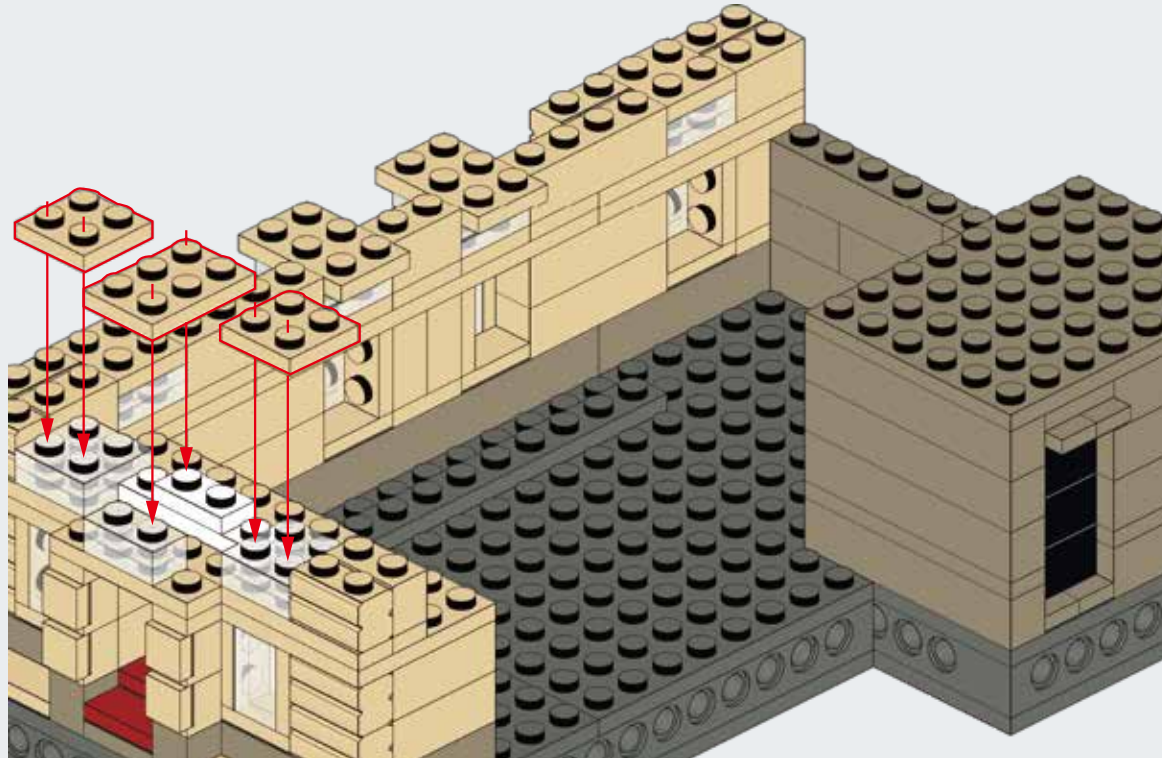

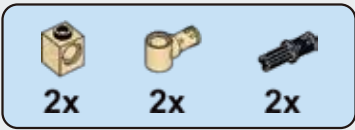

## A52

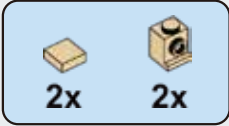
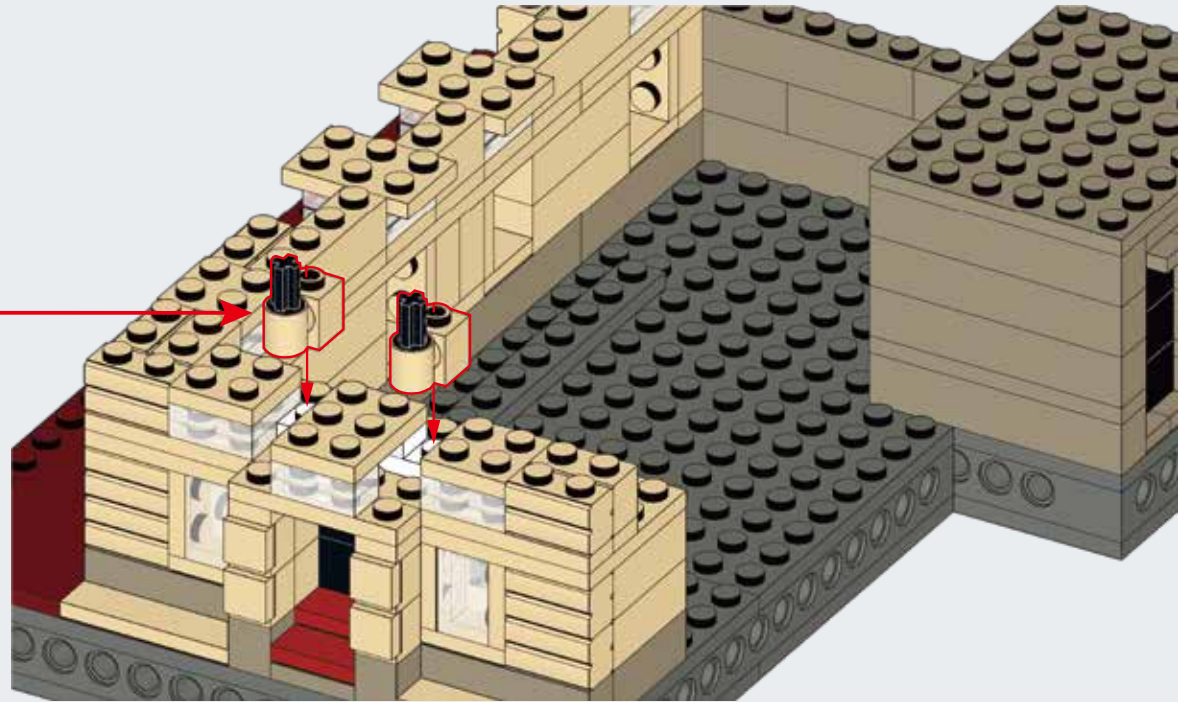
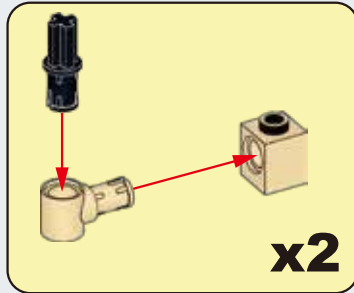

## A53

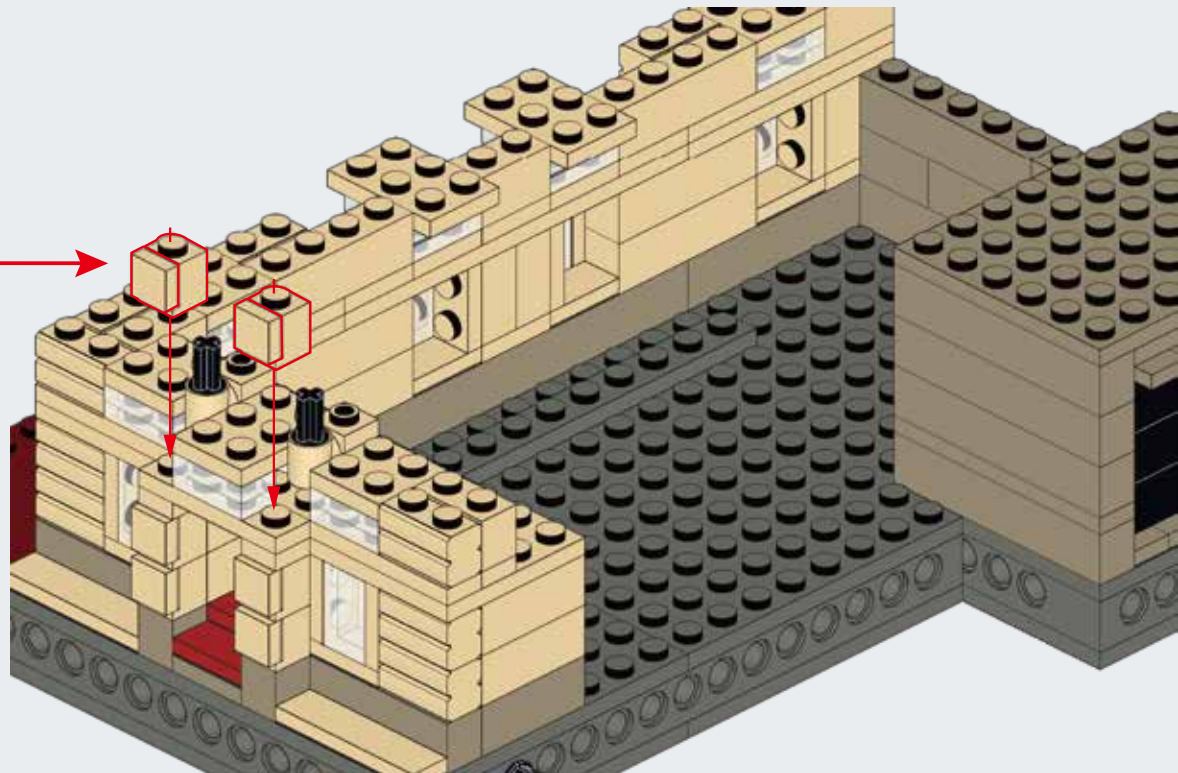
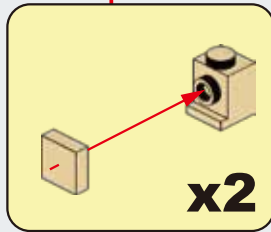



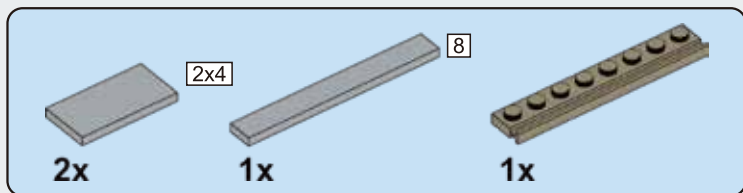

## A54

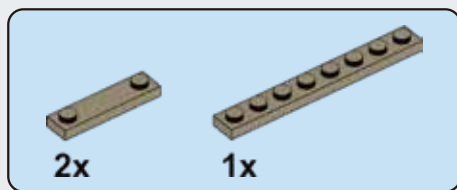
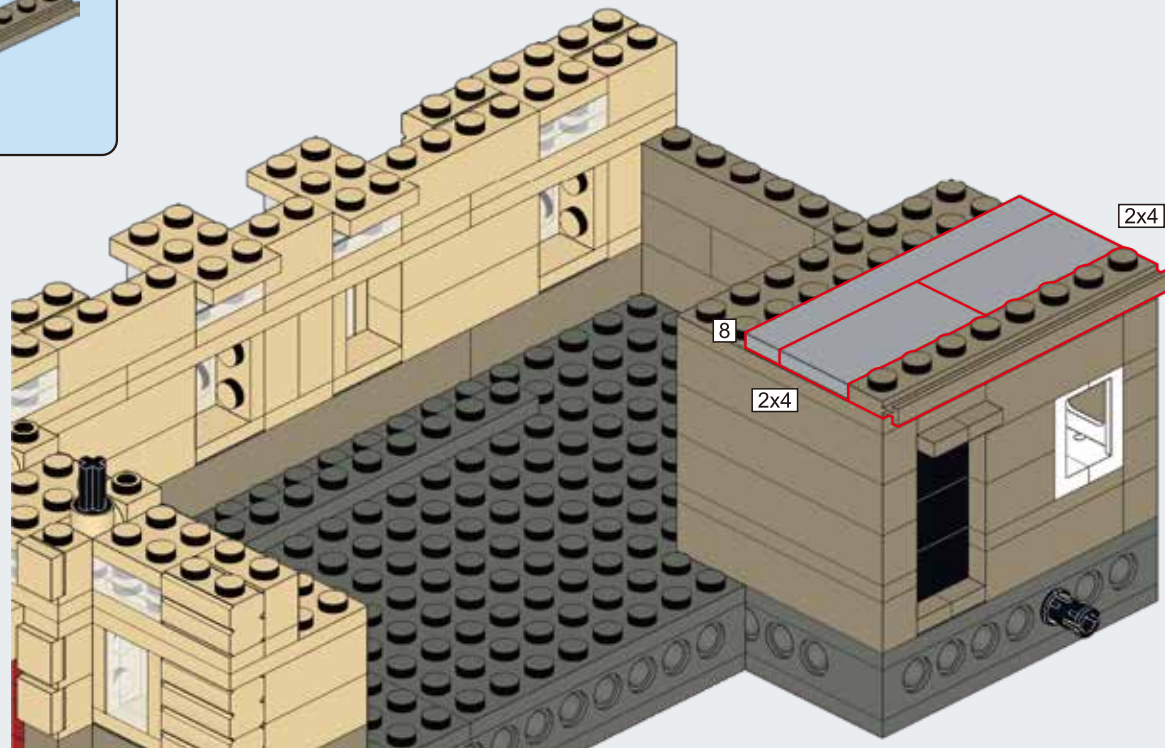

## A55

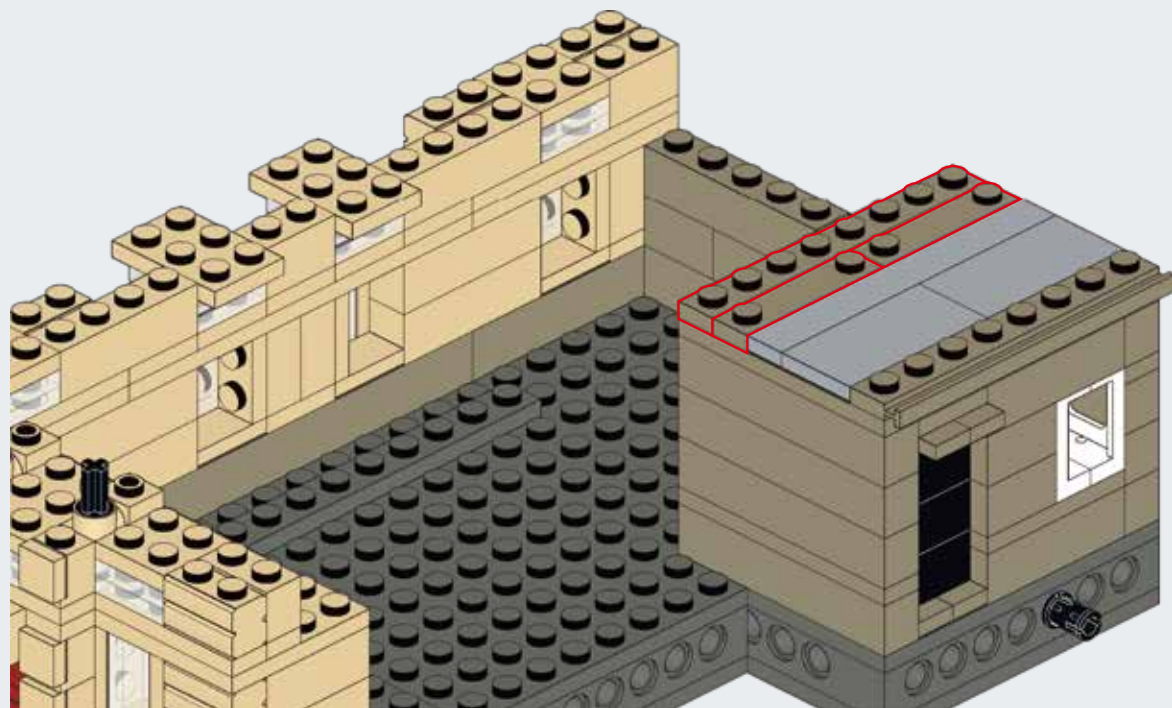



## A56

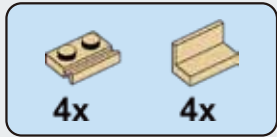
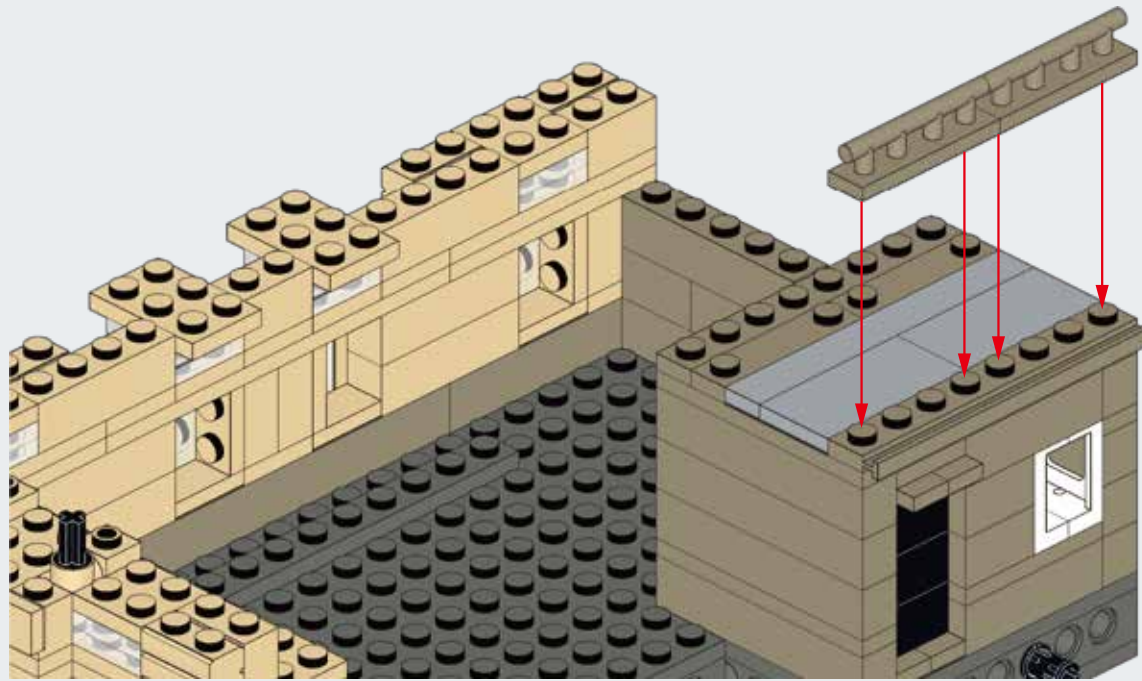

## A57

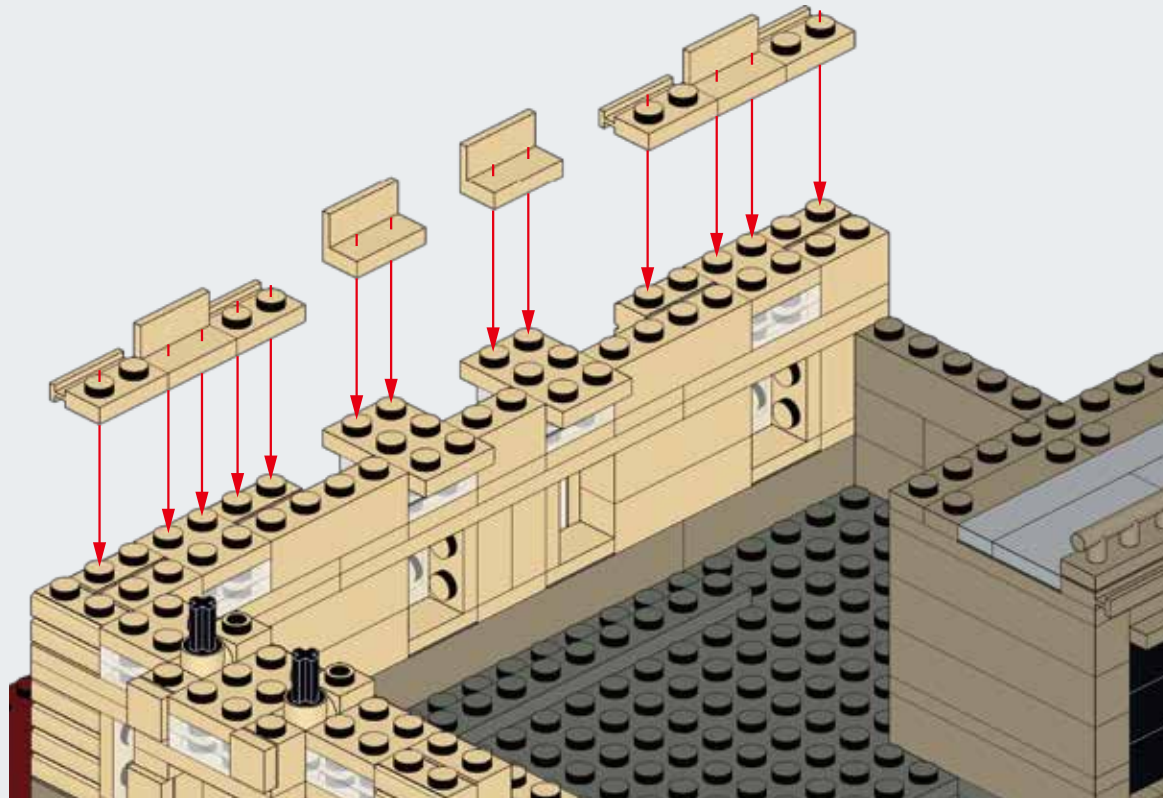



## A58

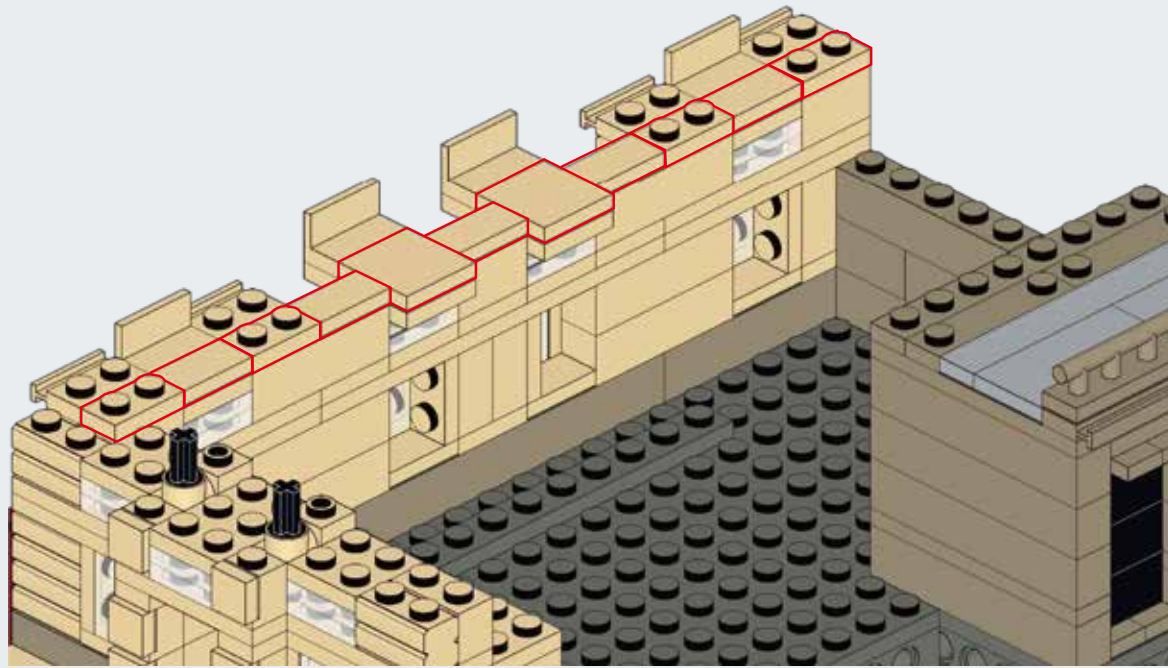

## A59

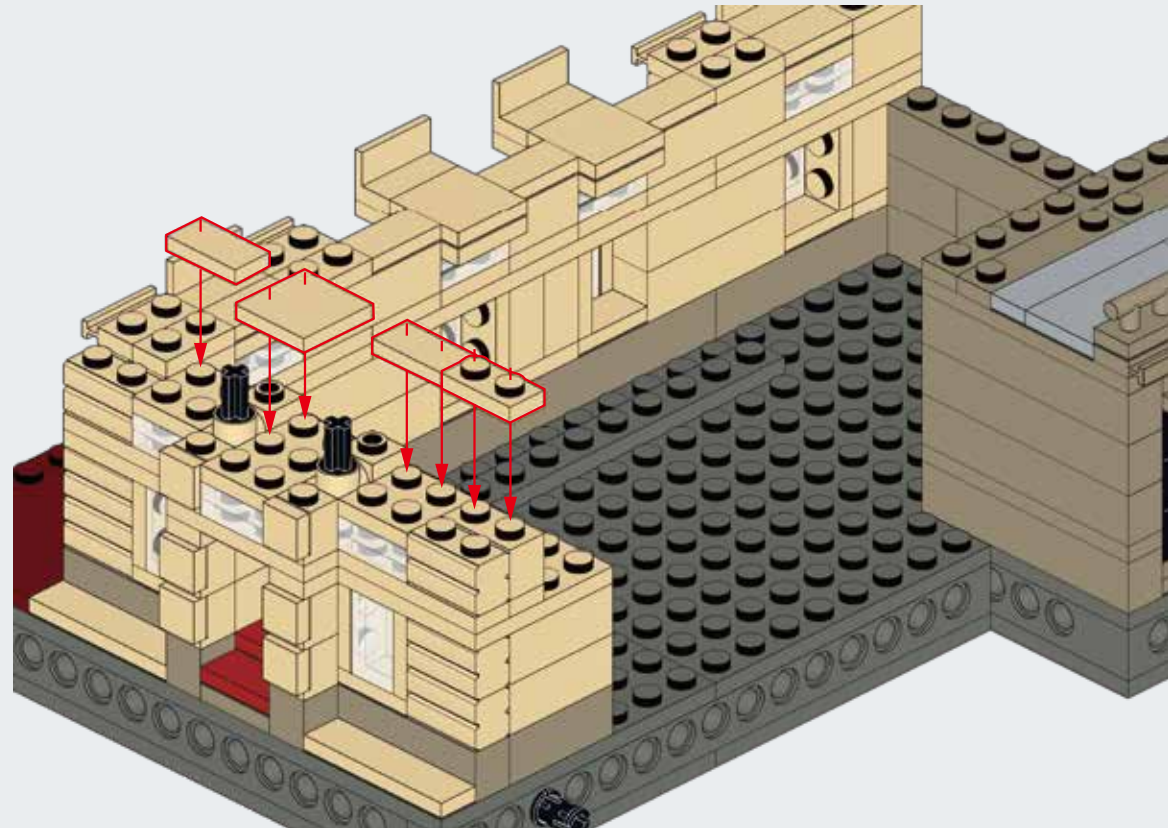



**A60**

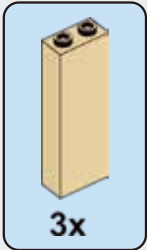
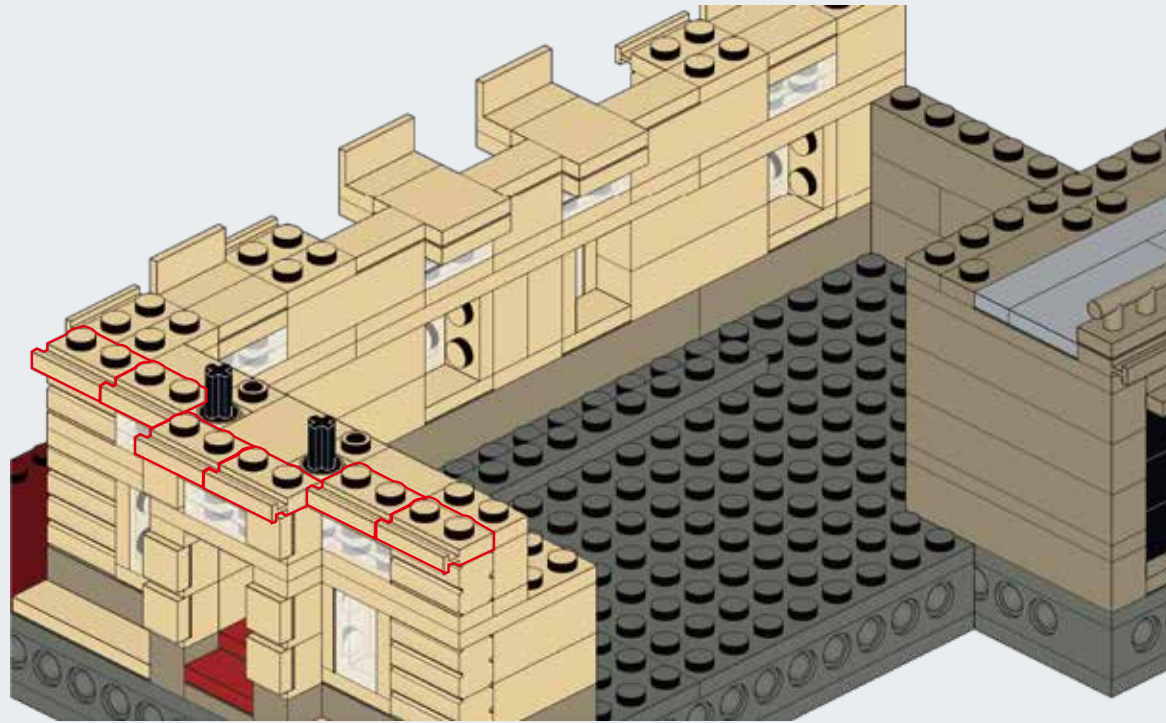

**A61**

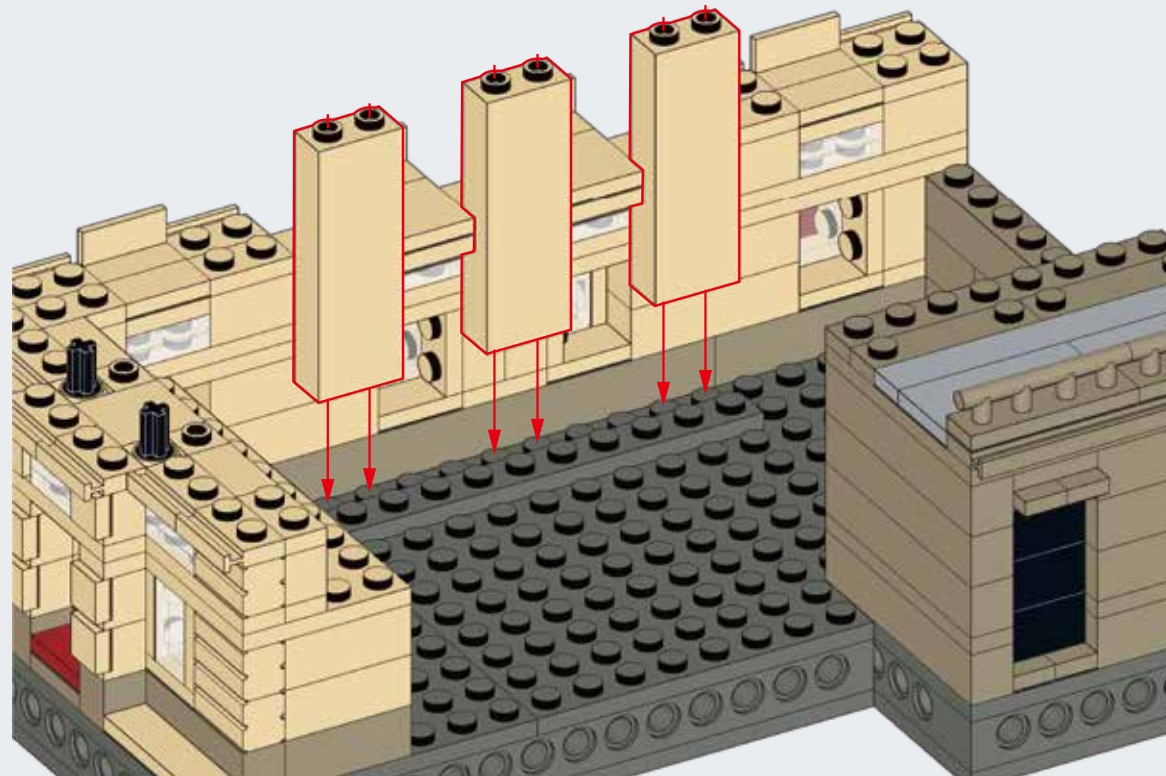

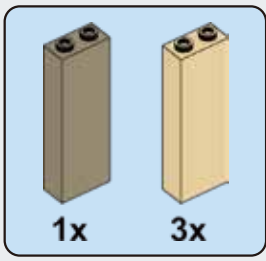

**A62**

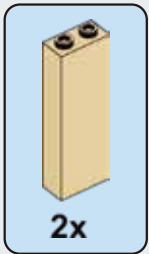
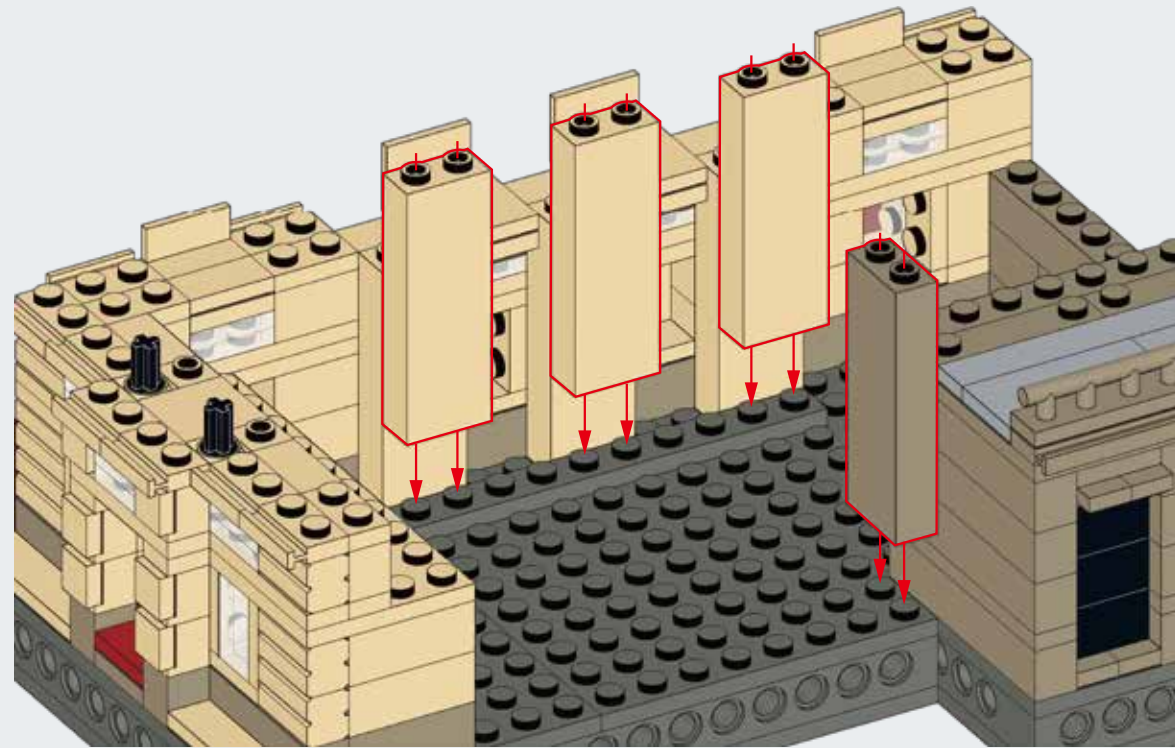

**A63**

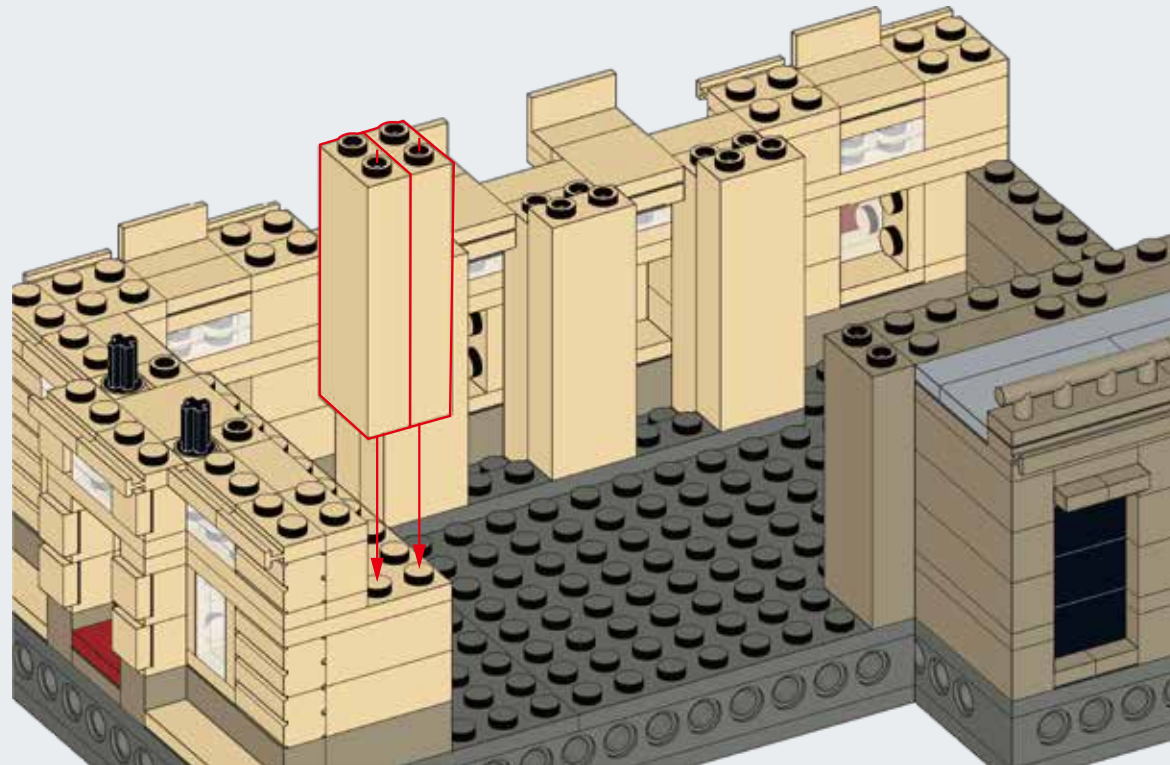



# A64

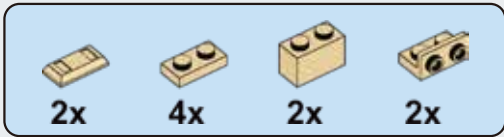
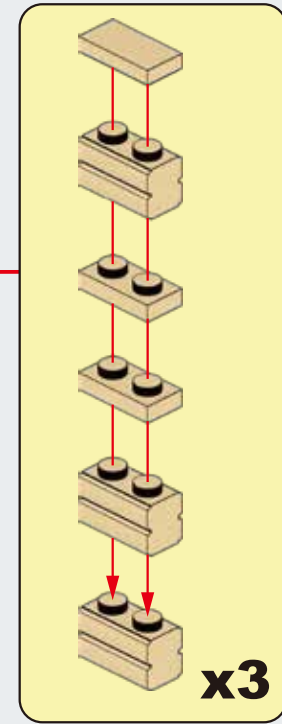
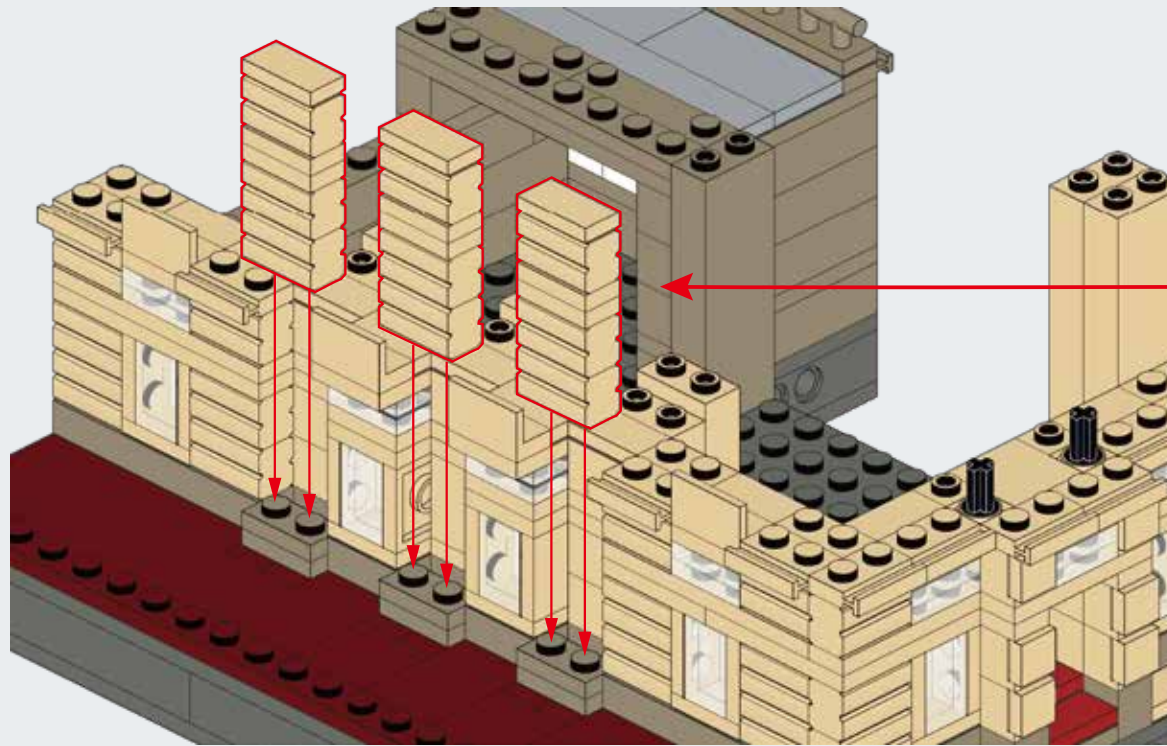

# A65

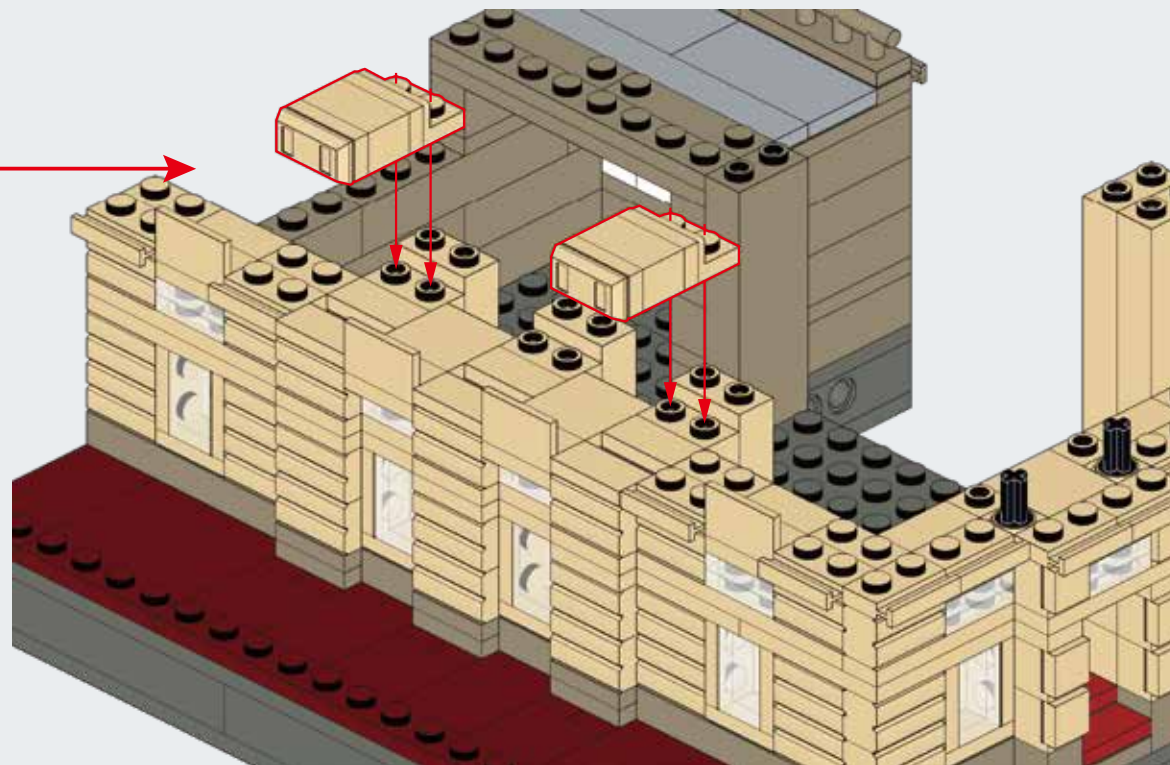
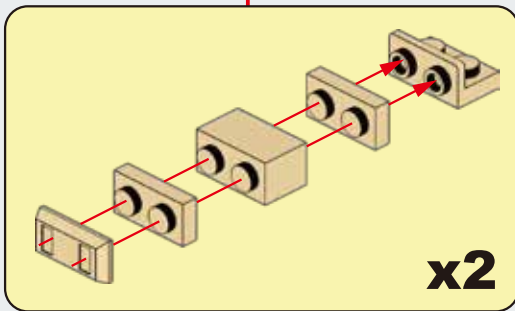



# A66

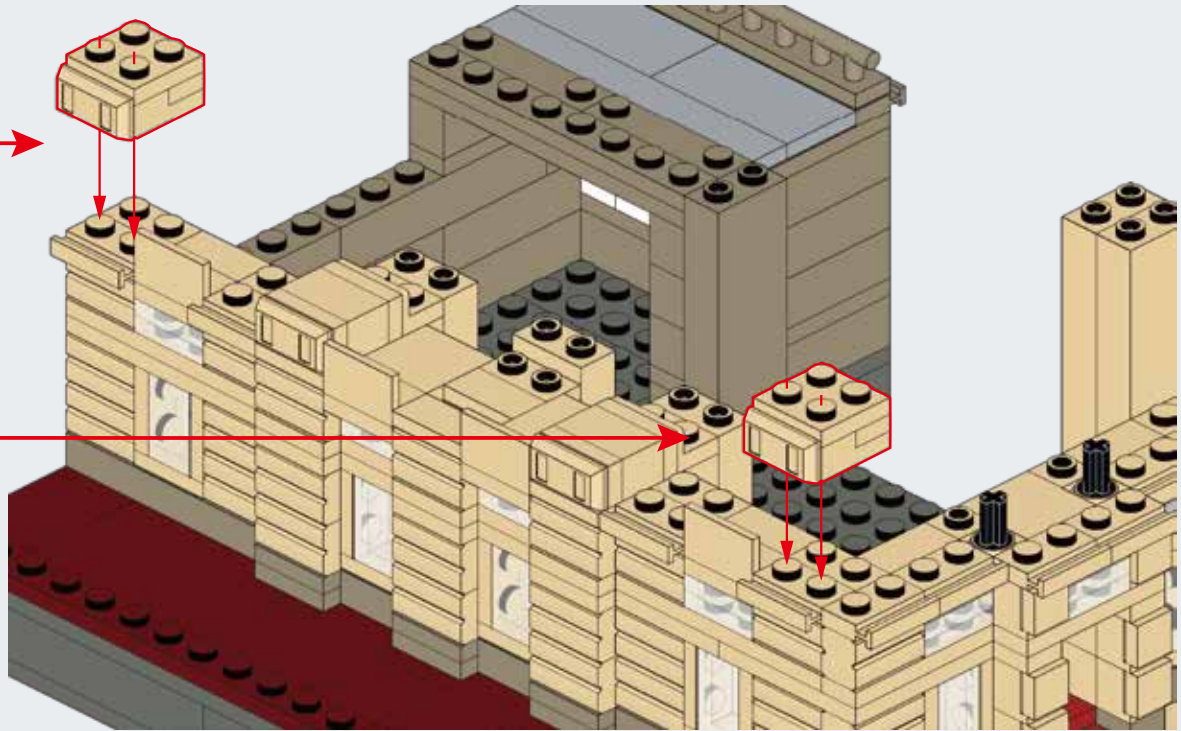
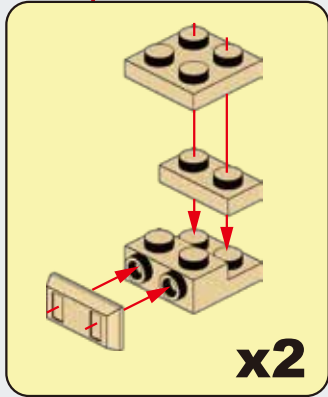

# A67

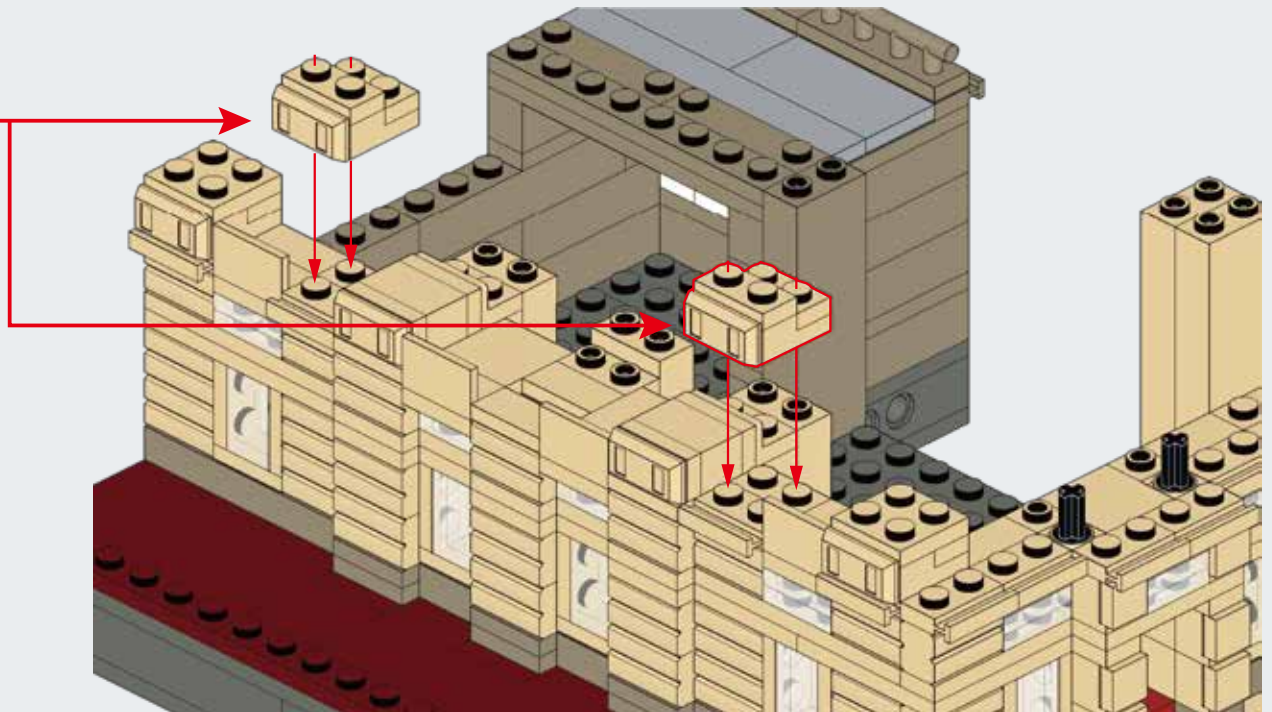
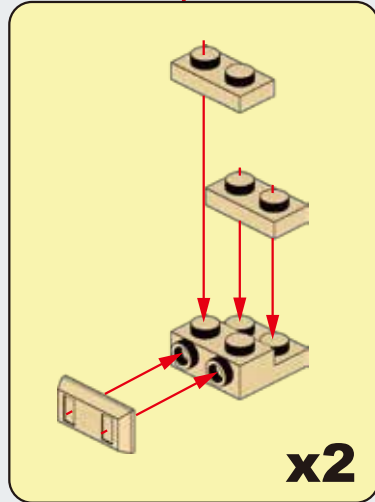

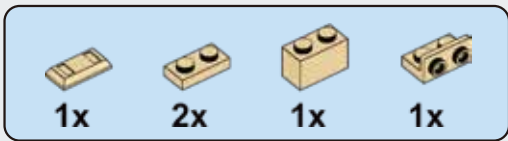

## A68

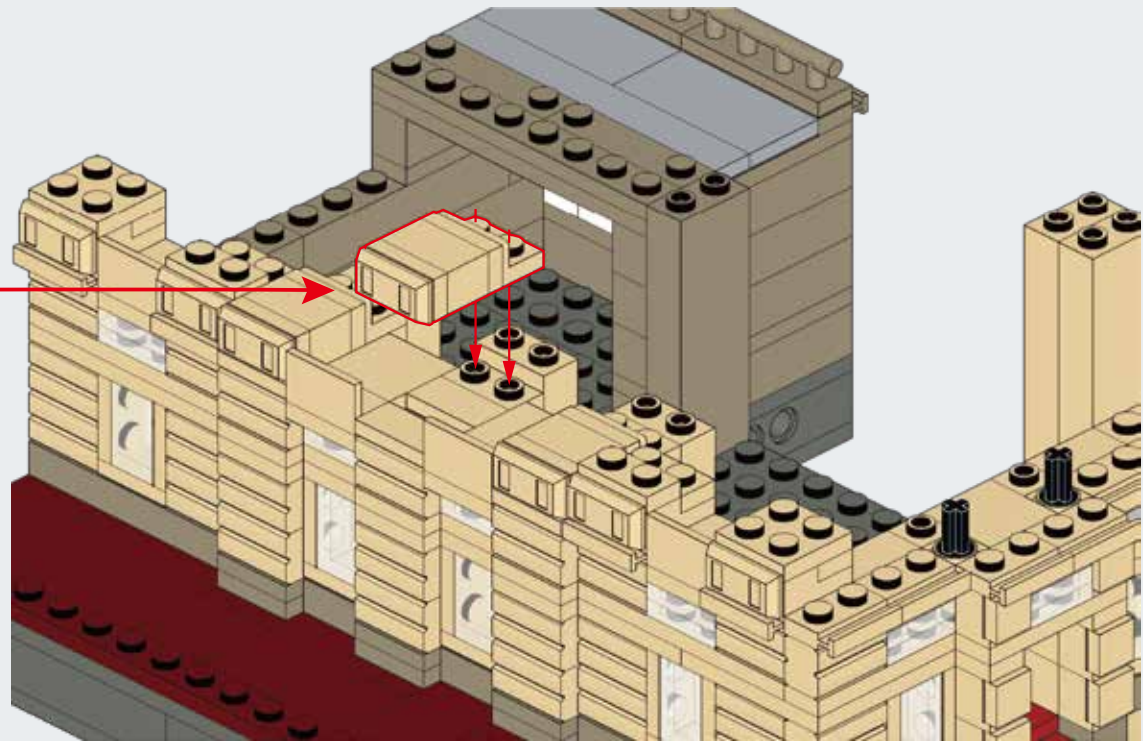
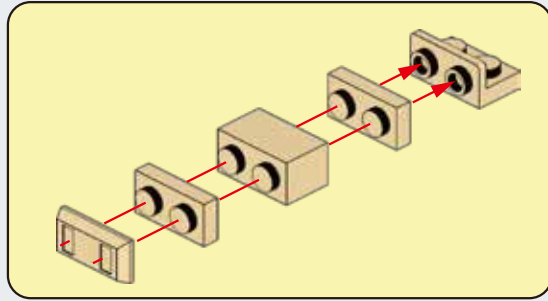

## A69

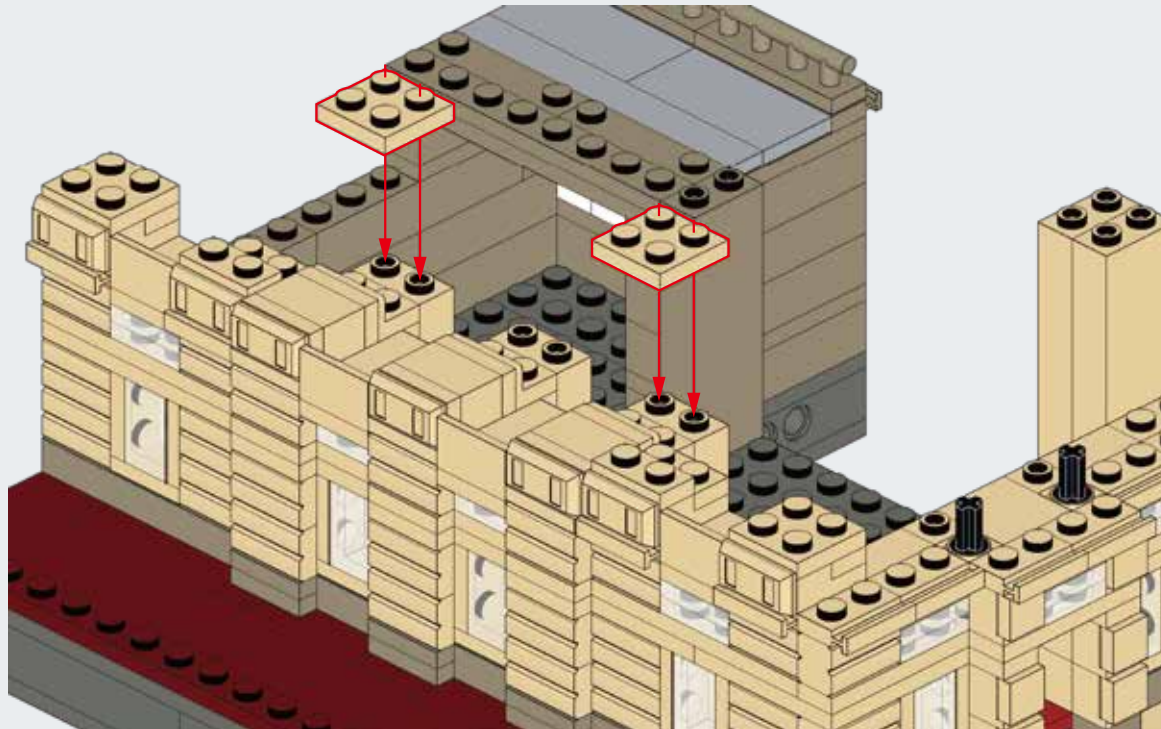



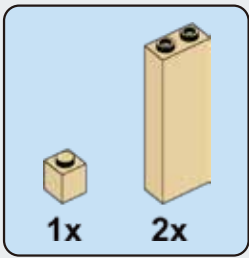

## A70

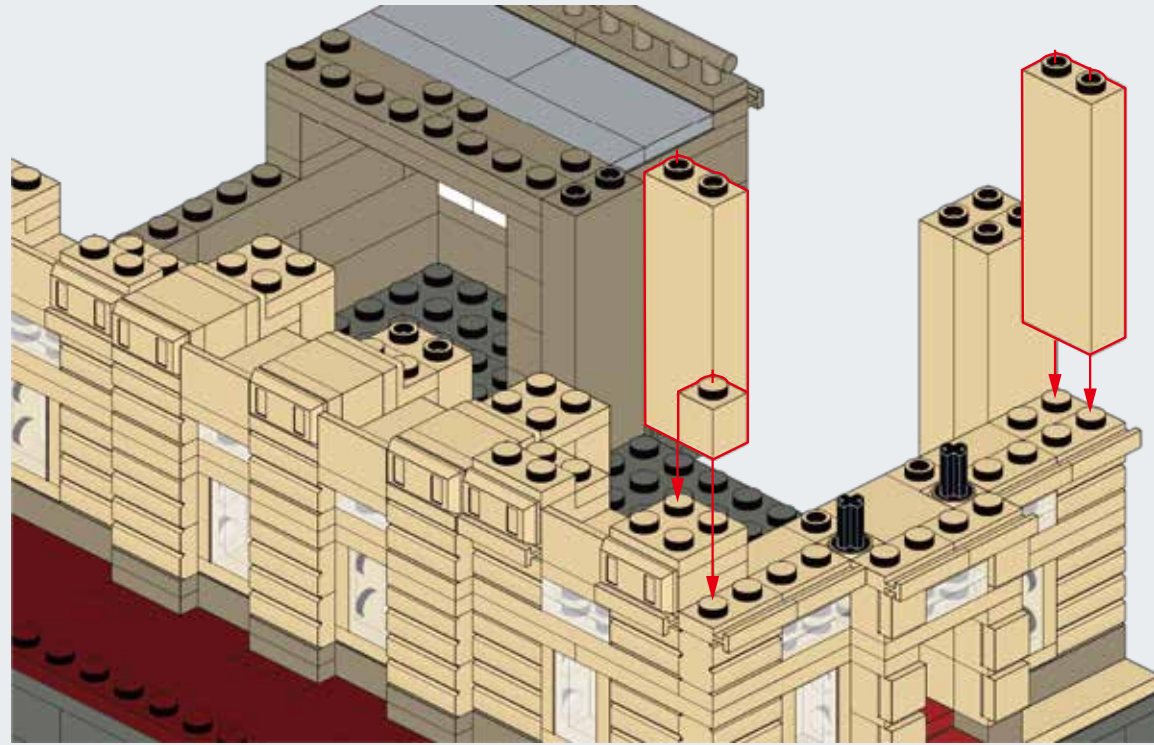

## A71

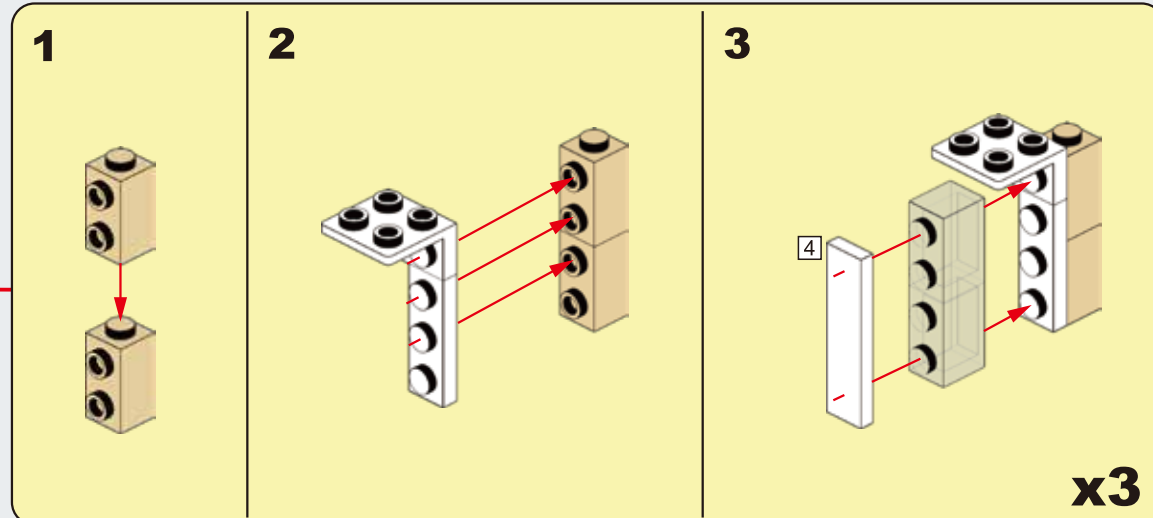
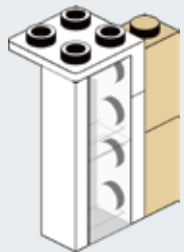

# A72

A70

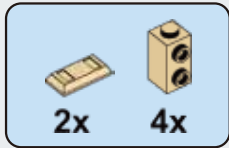
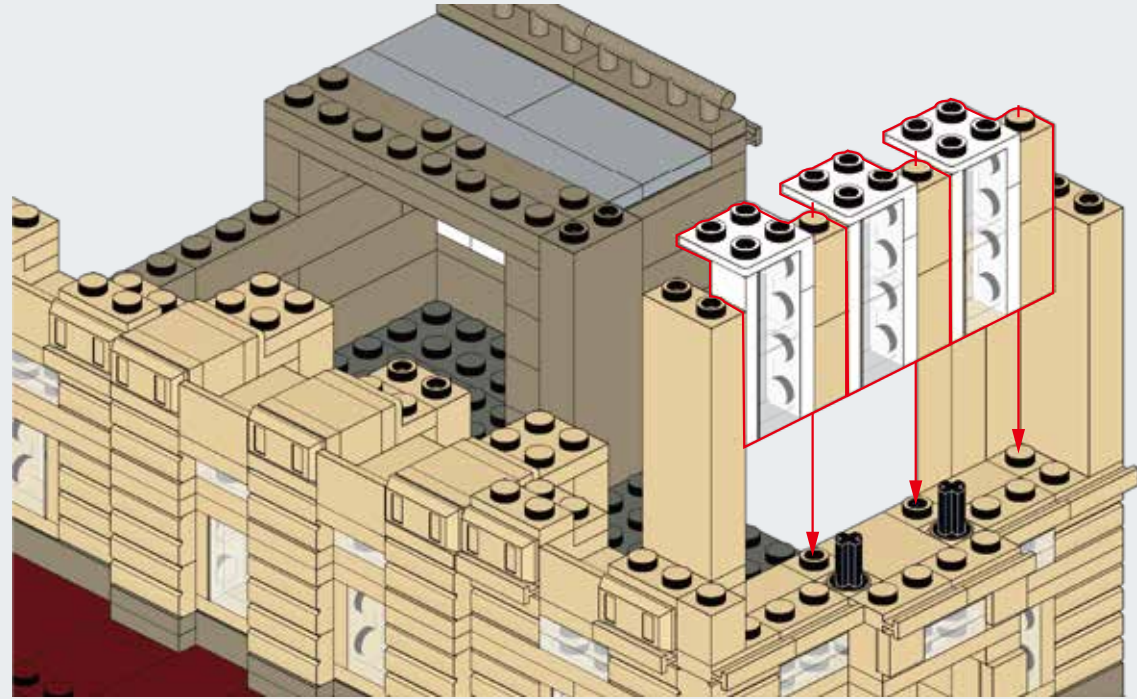

# A73

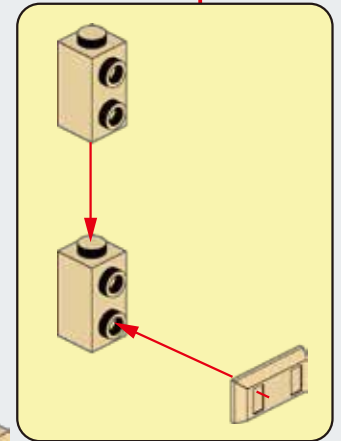
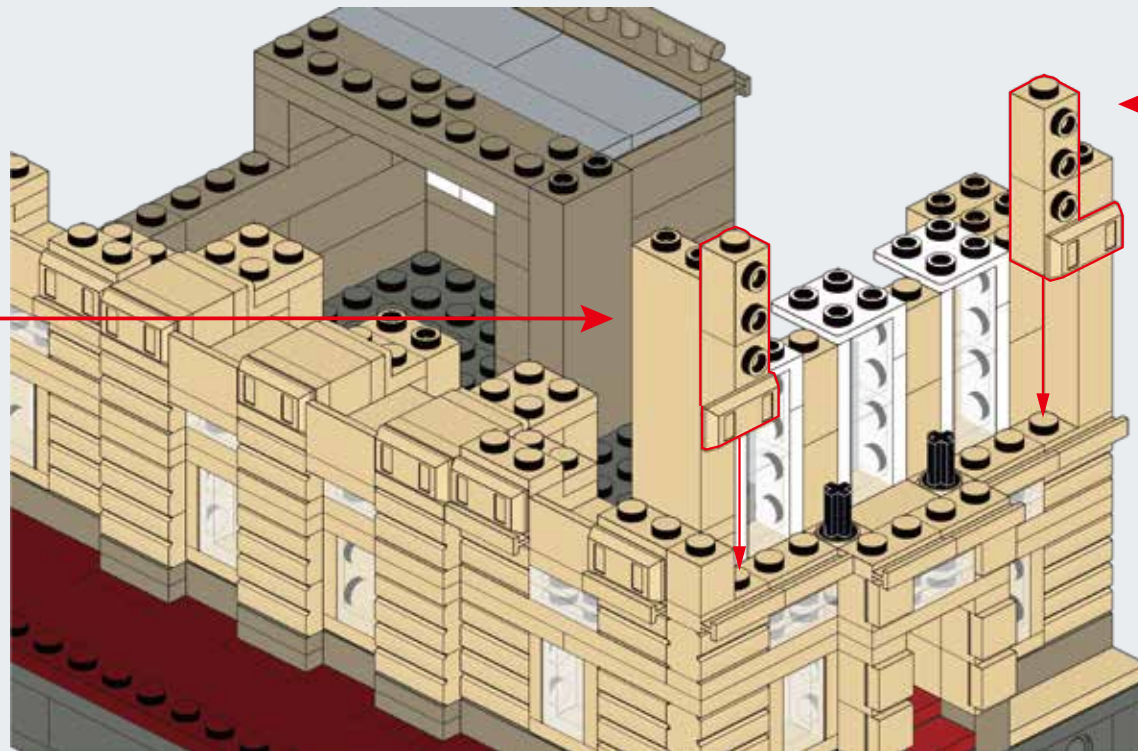
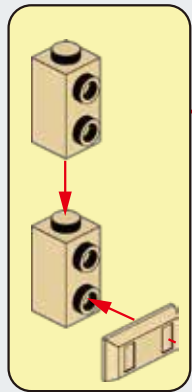

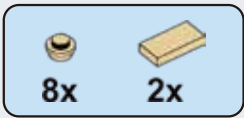

# A74

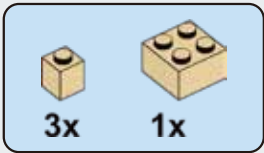
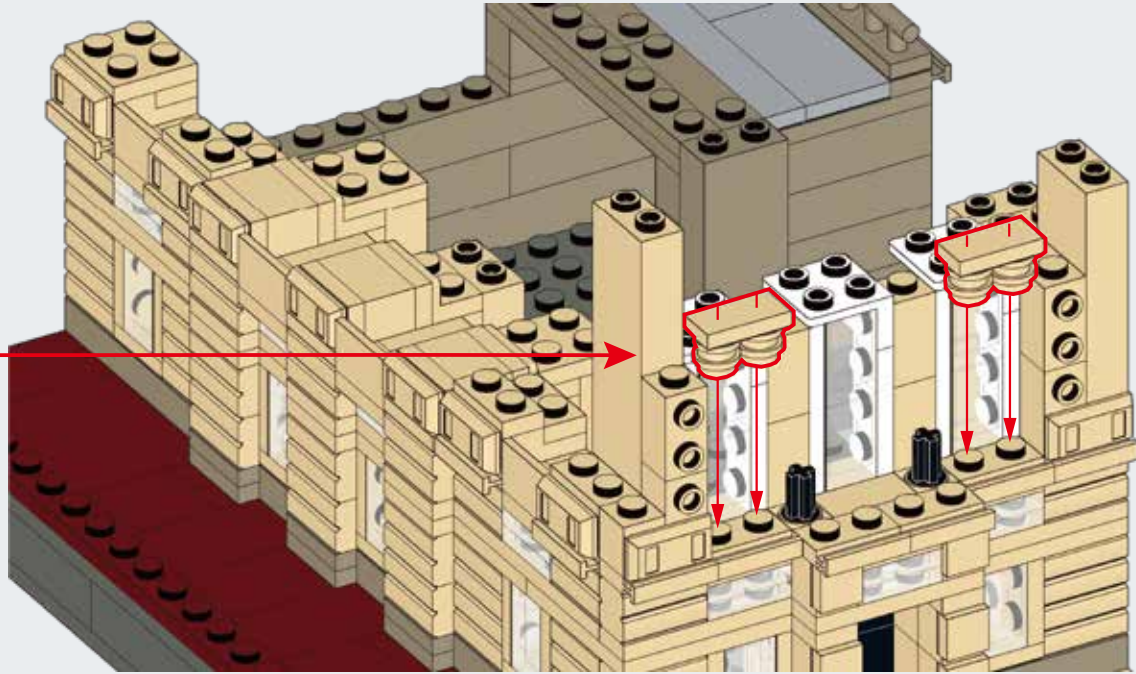
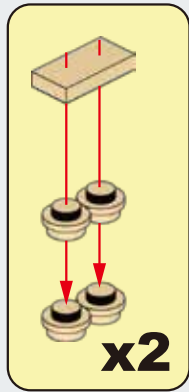

# A75

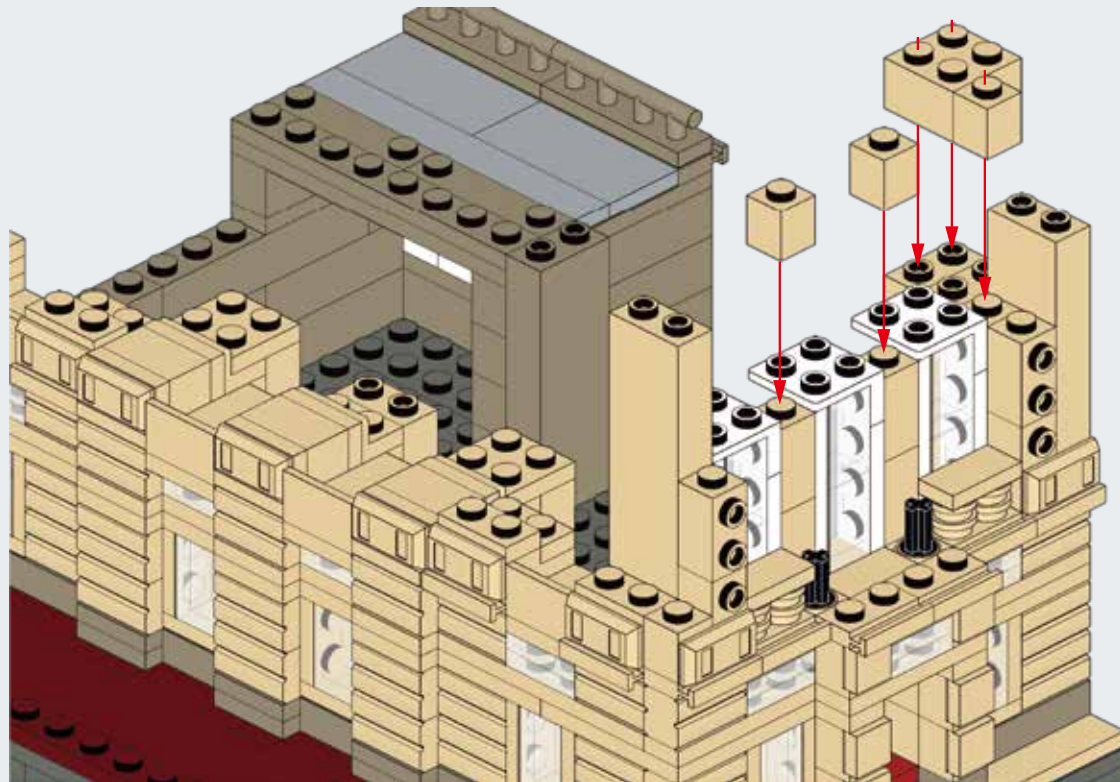

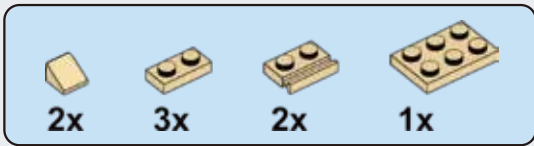

# A76

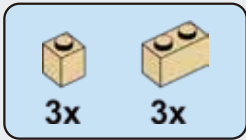
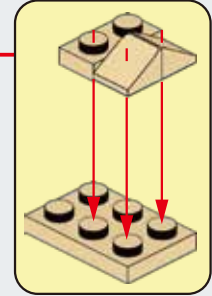
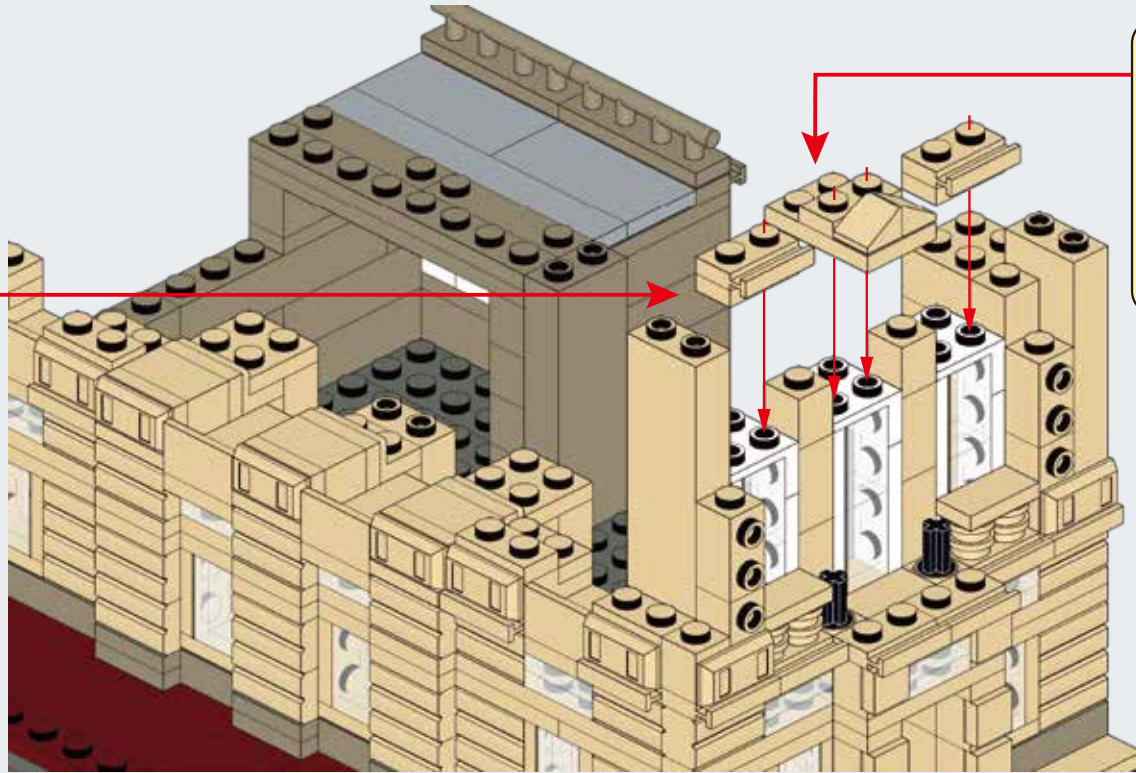
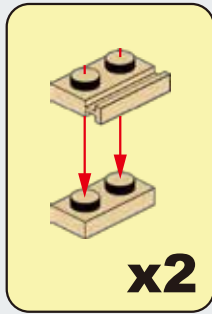

# A77

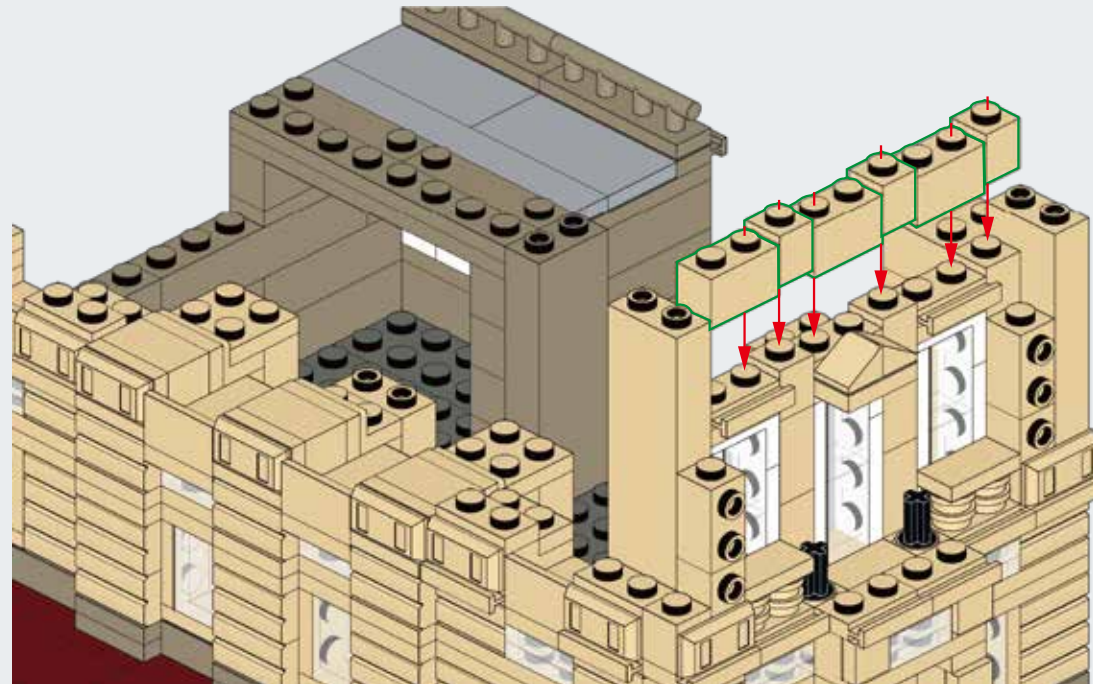



**A78**

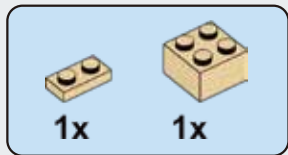
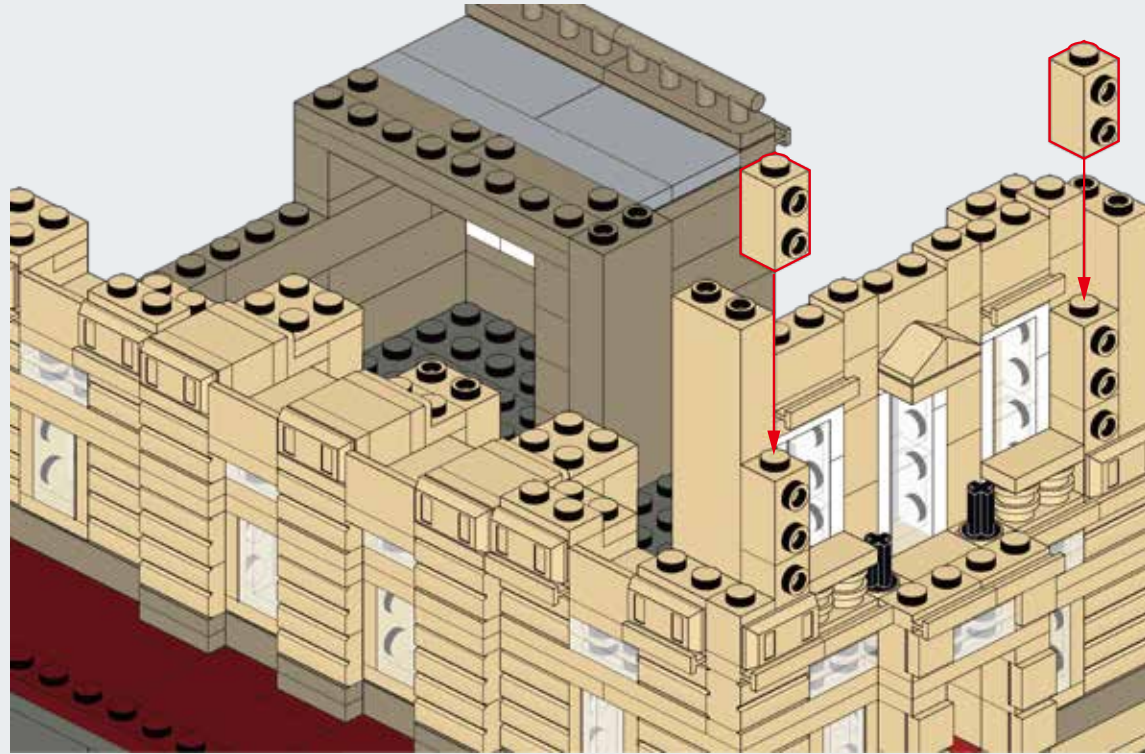

**A79**

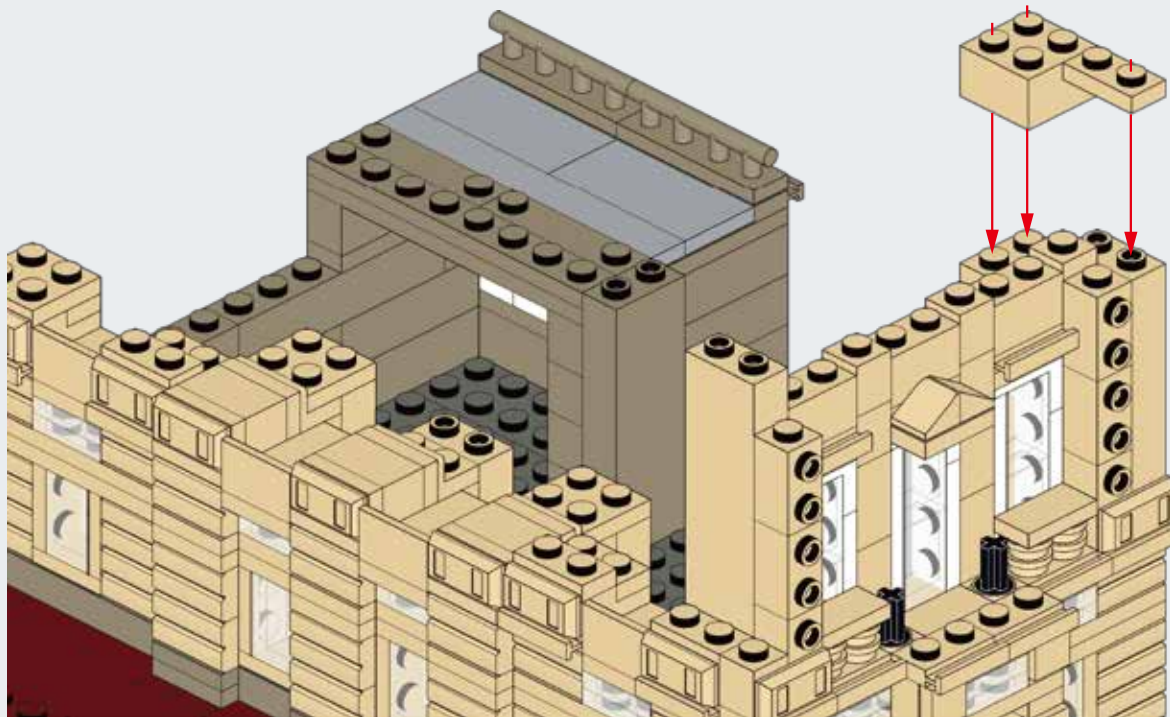



**A80**

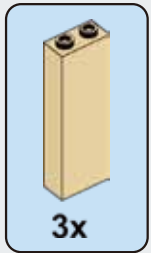
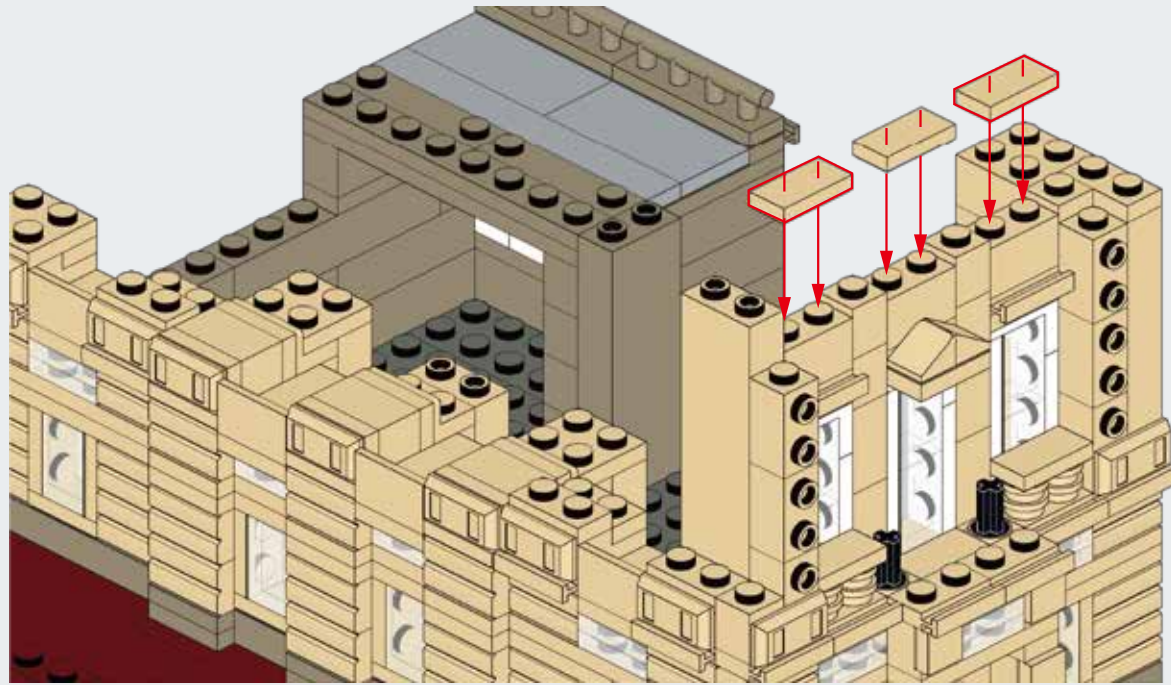

**A81**

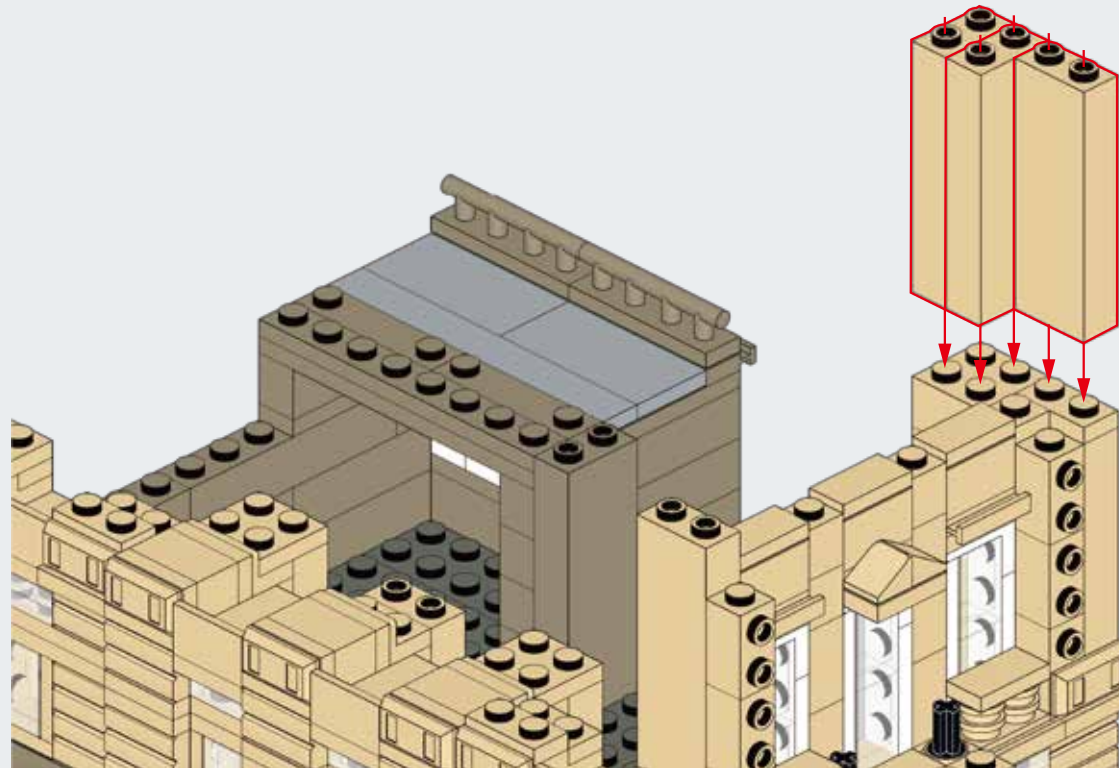



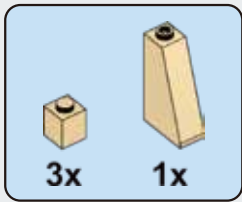

**A86**

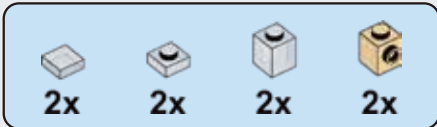
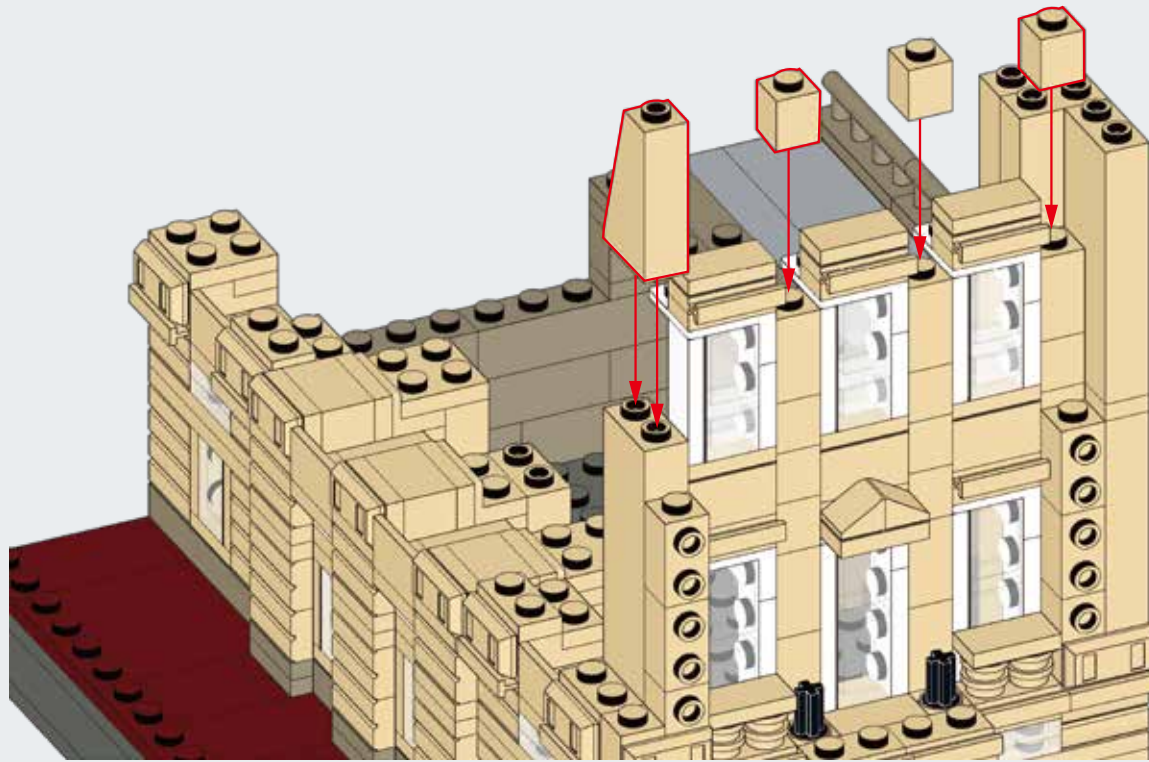

**A87**

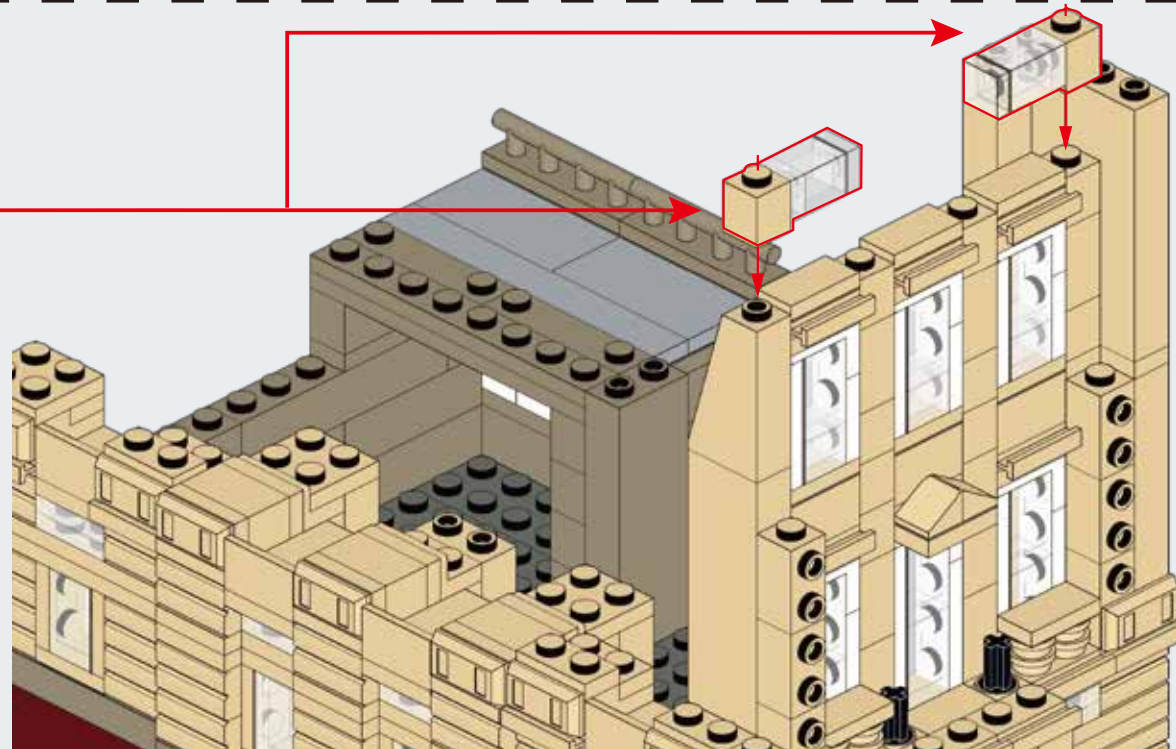
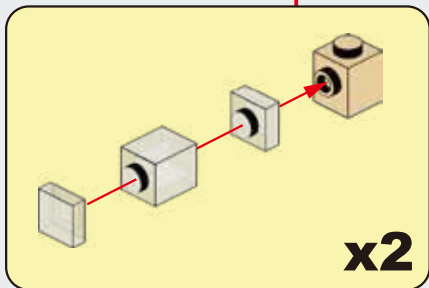





**A88**

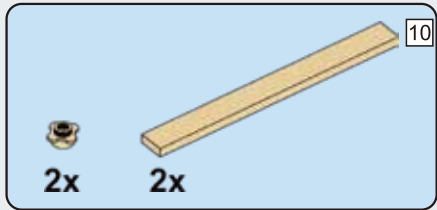
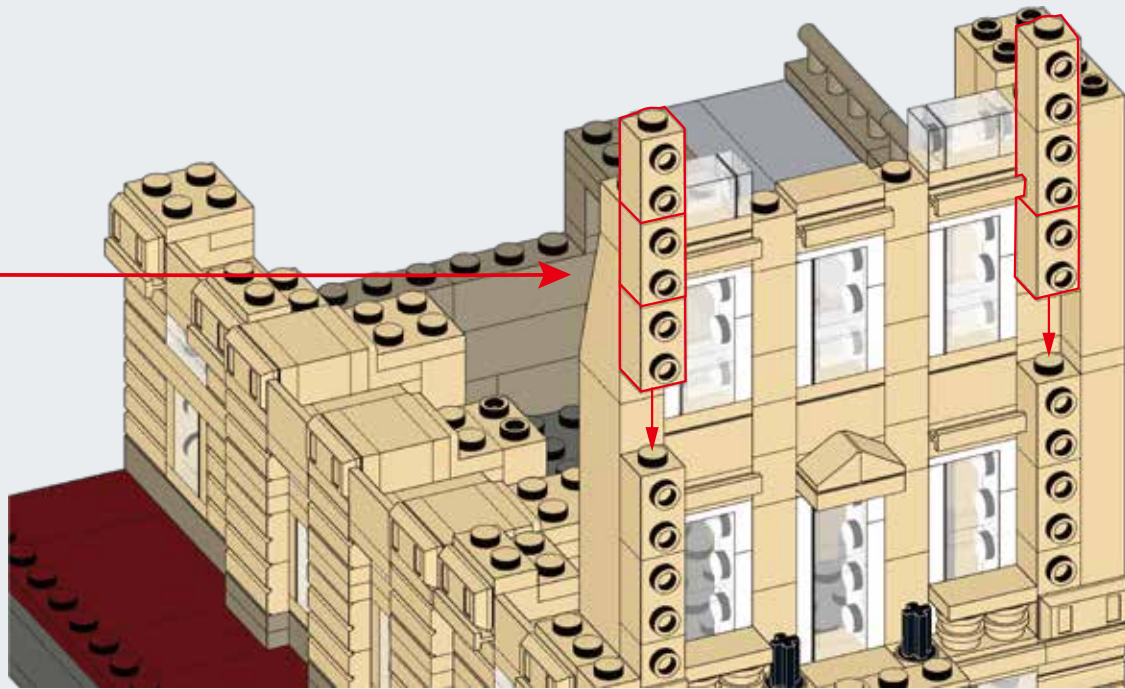
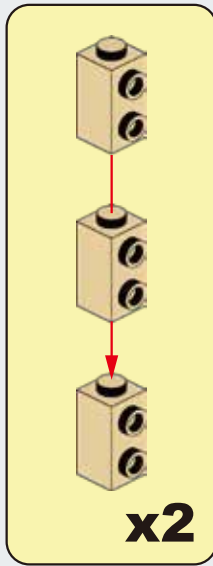

**A89**

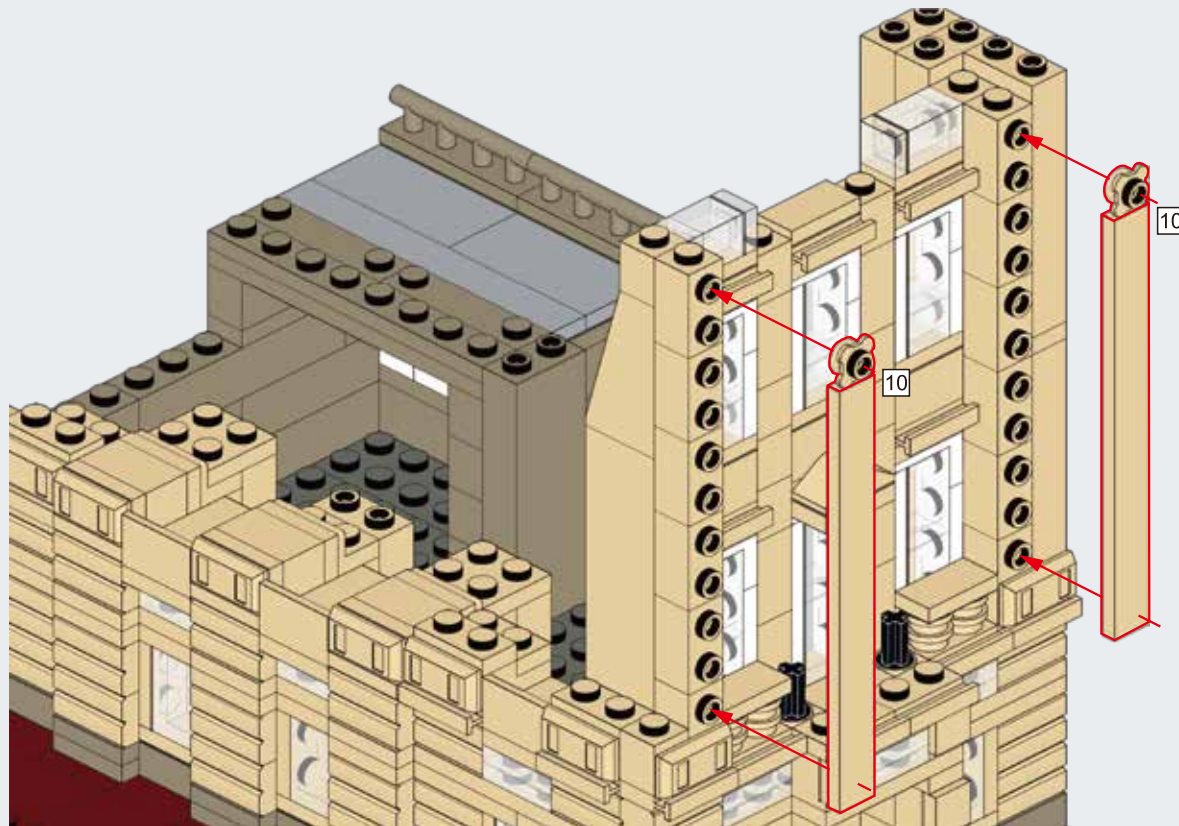

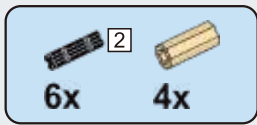

**A90**

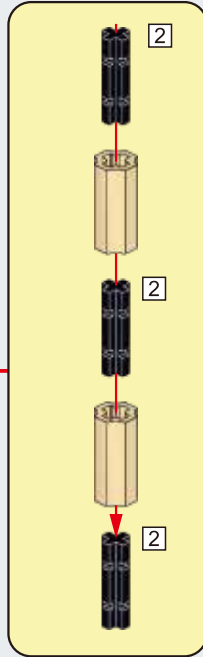

**x2**

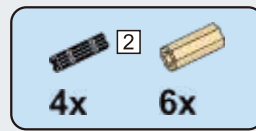

**A91**

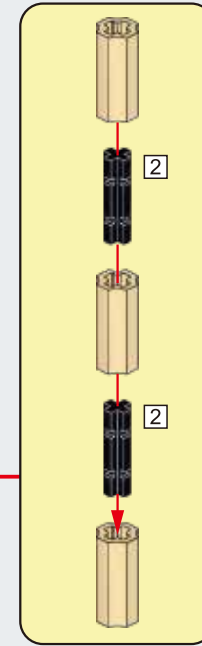

**x2**

**A92**

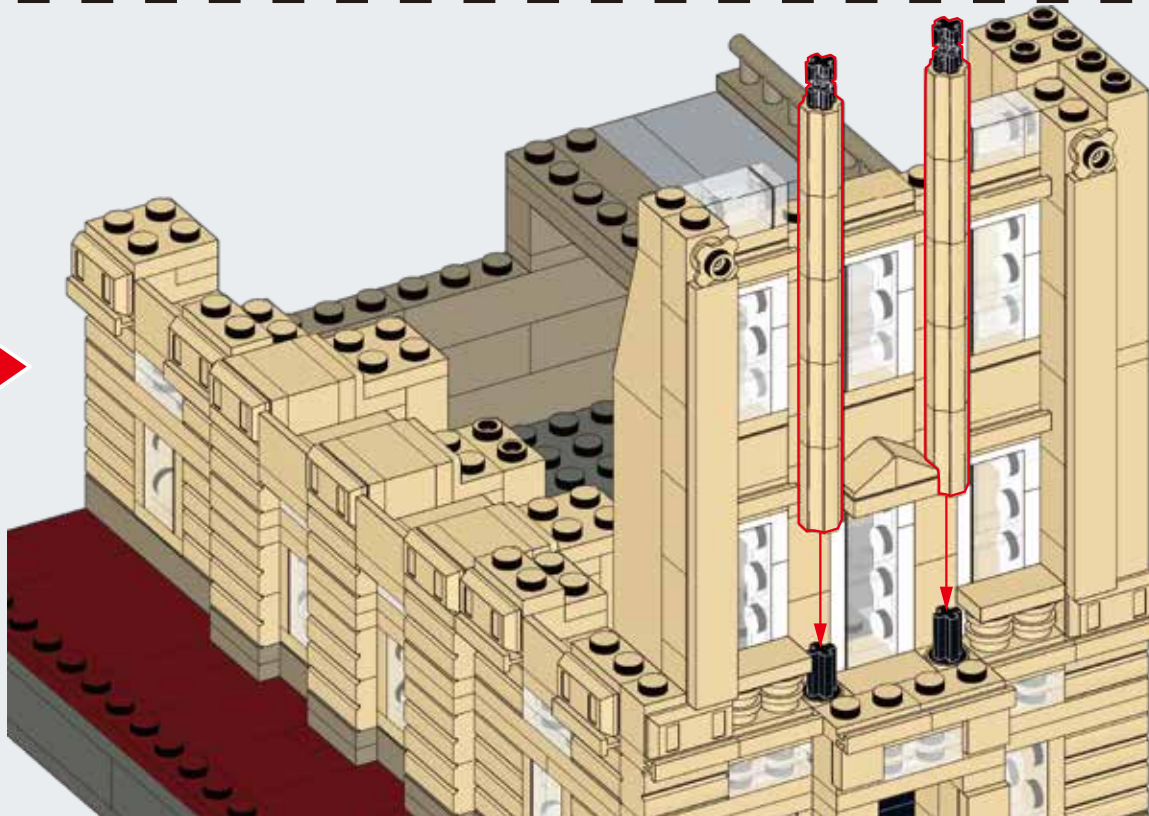

**A89**

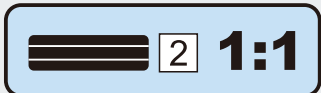



# A93

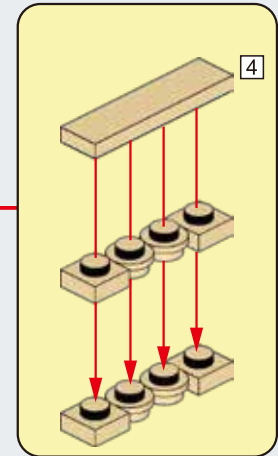
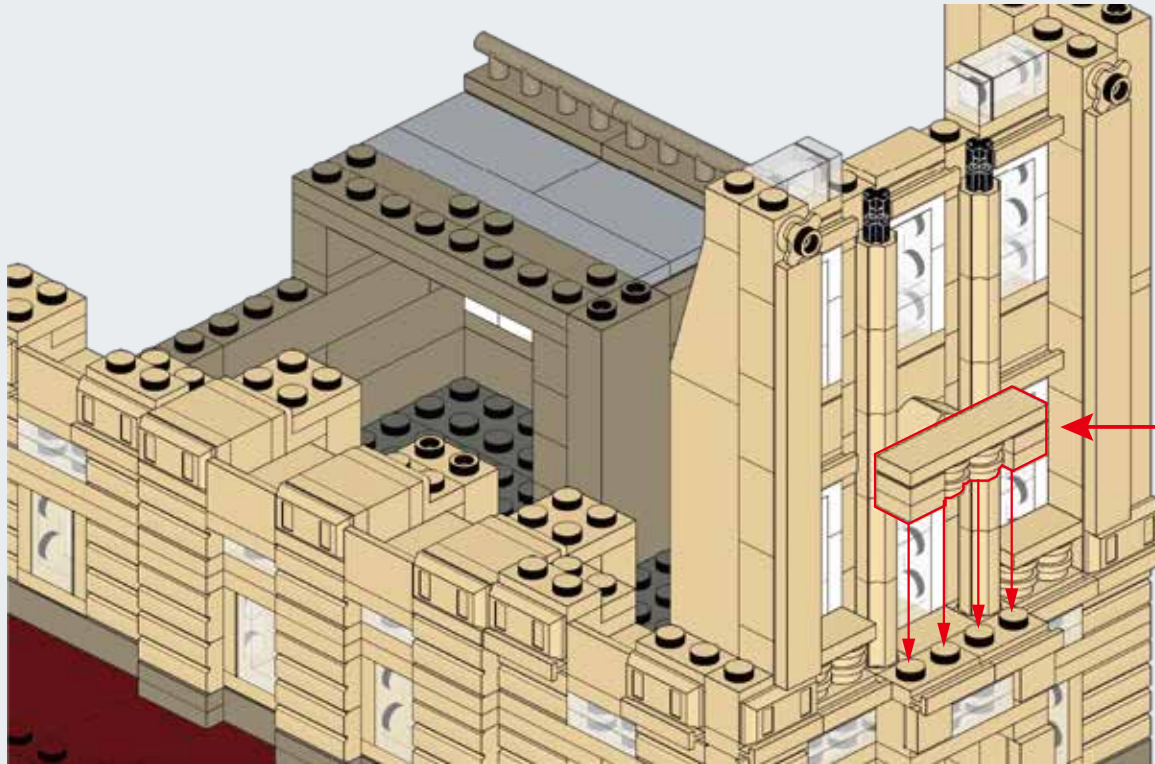

# A94

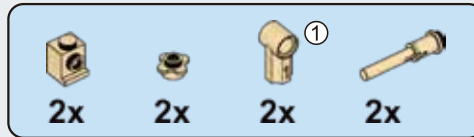
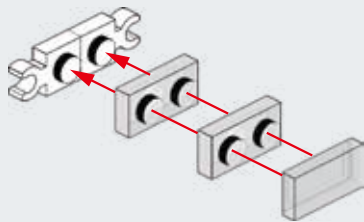

# A95

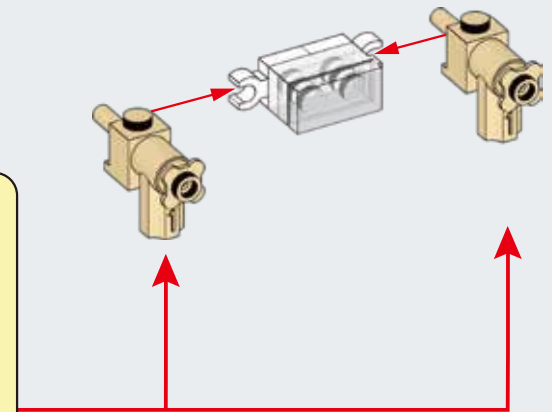
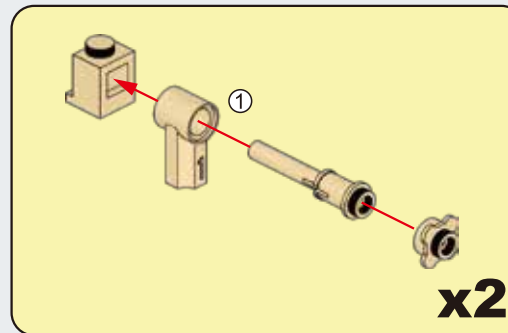

**A96**

**A93** →

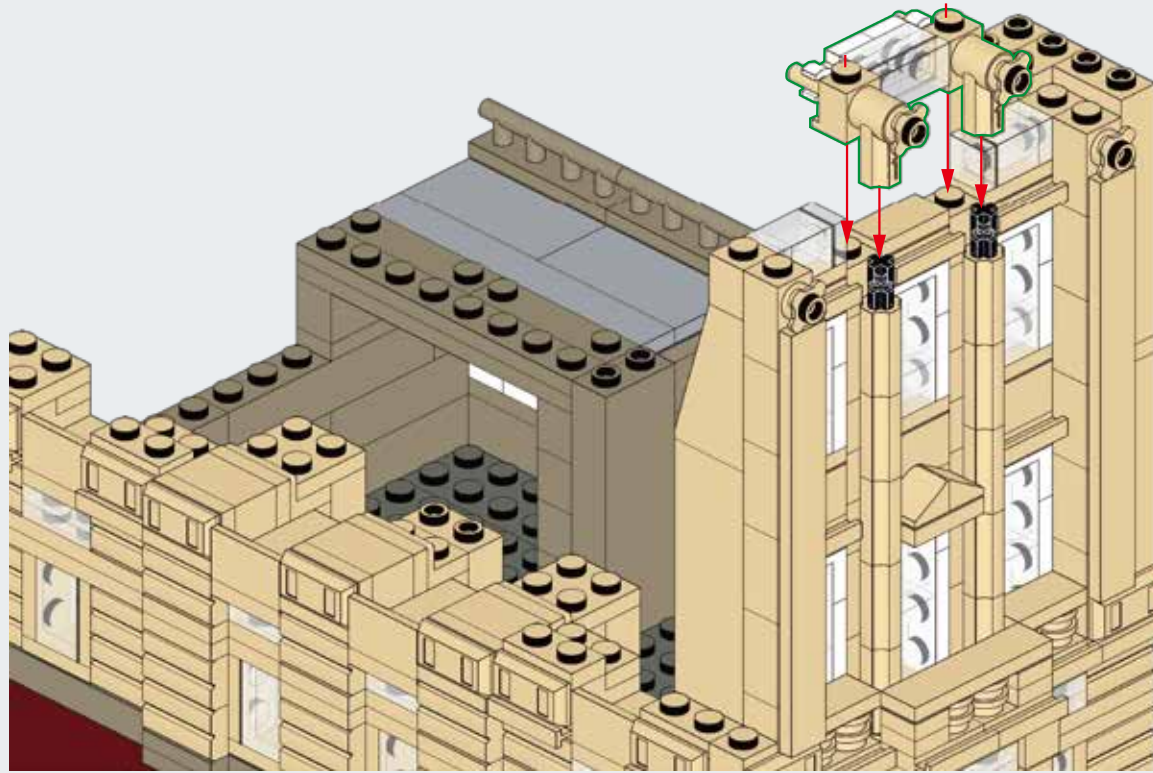

**A97**

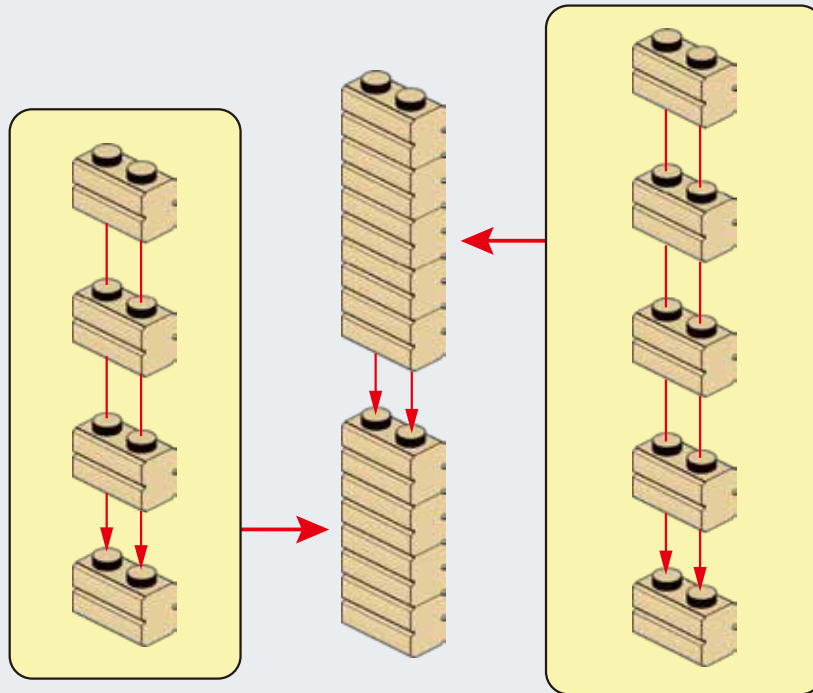

**A98**

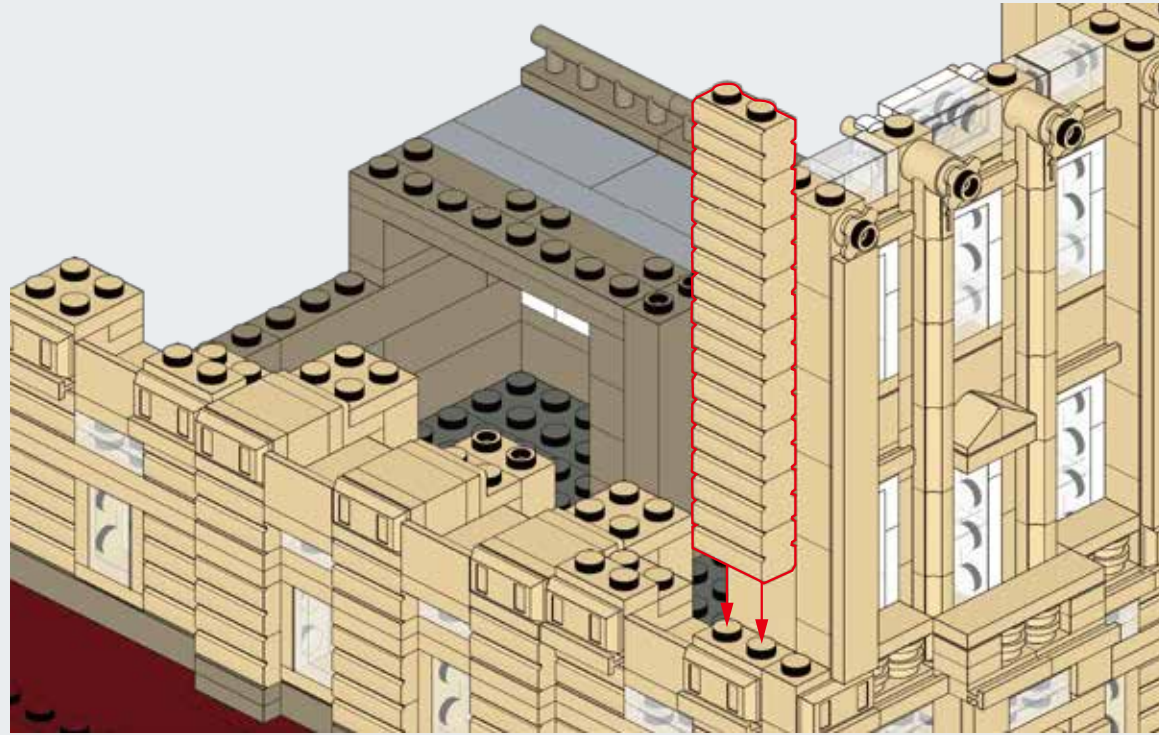

**A96** →



**A99**

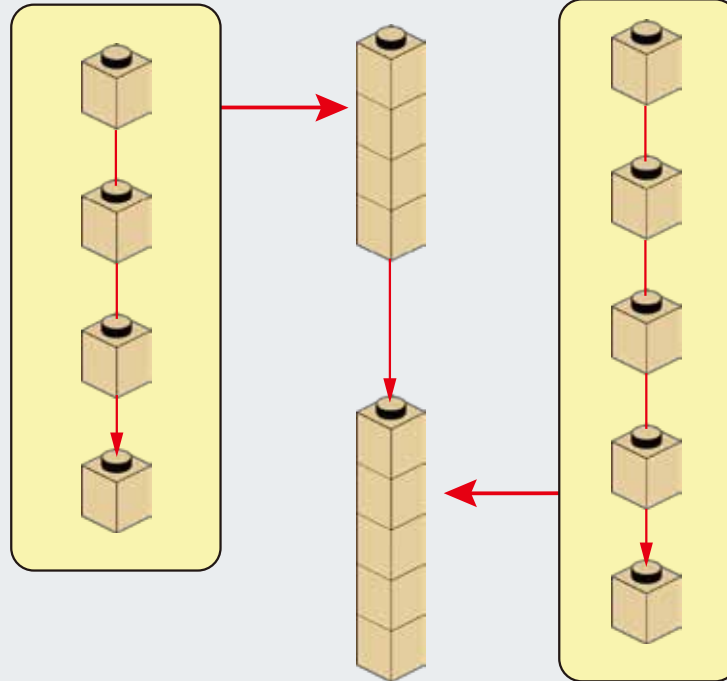

# A100

A98

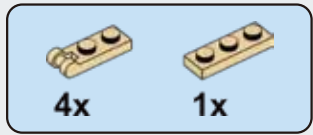
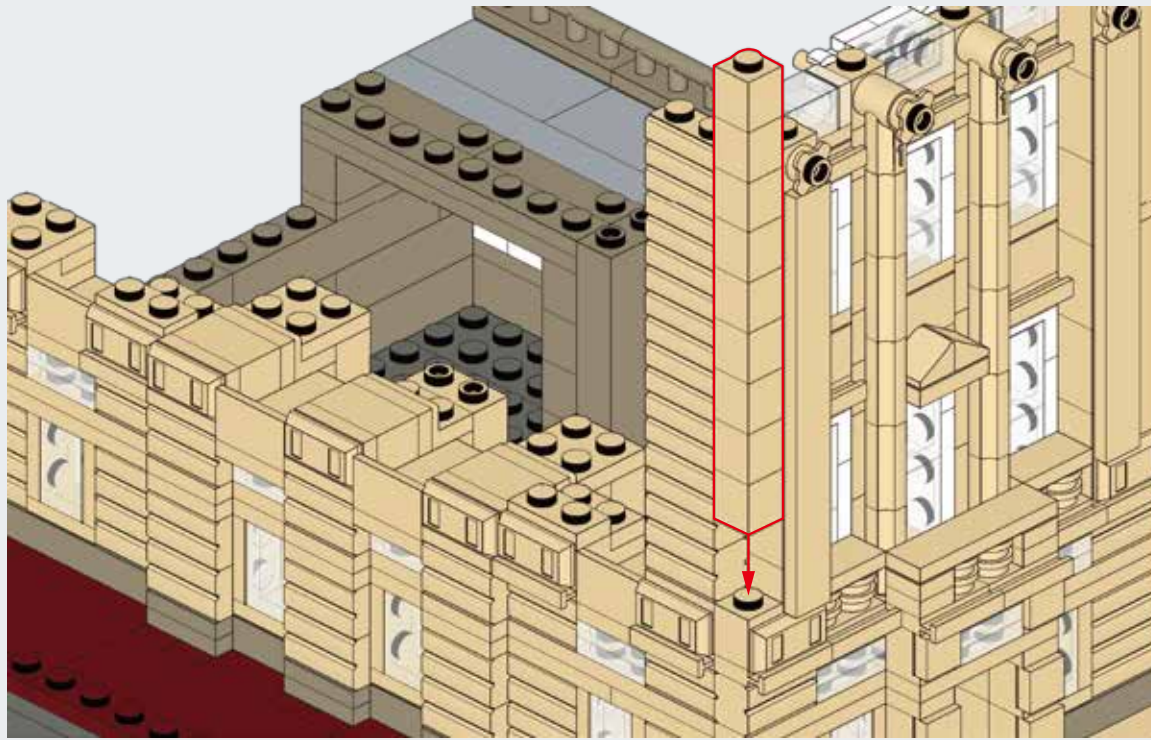

# A101

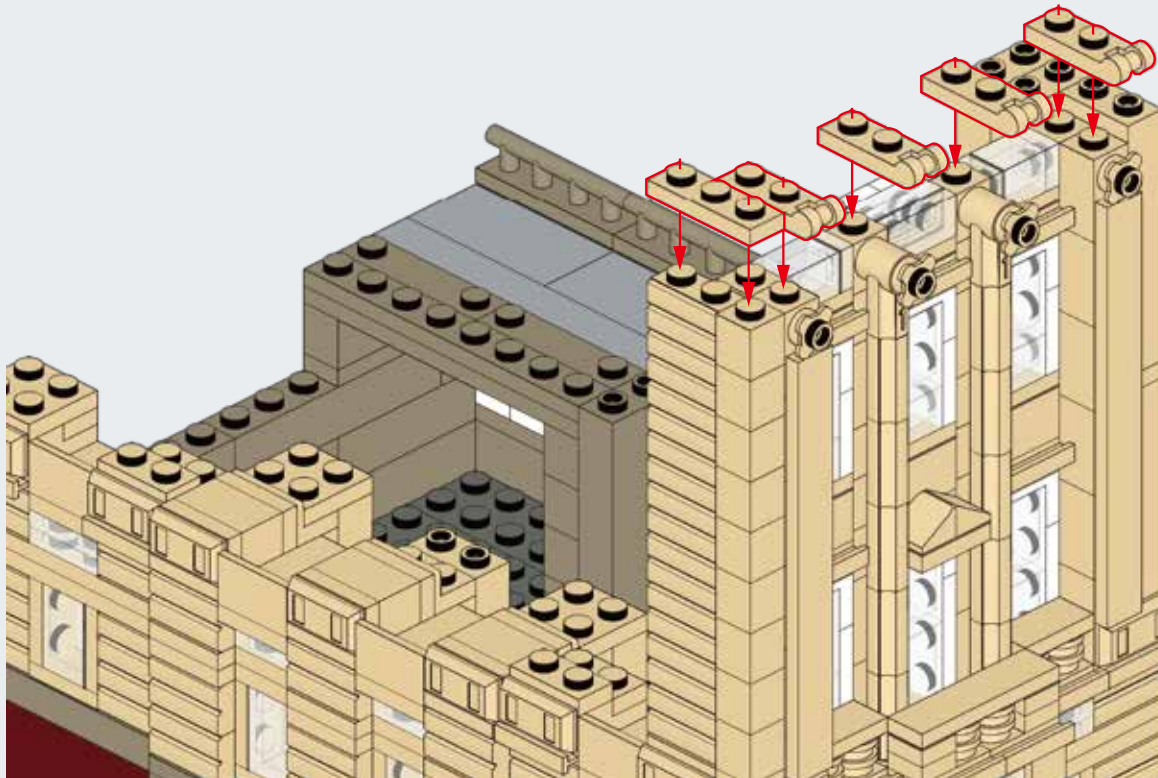

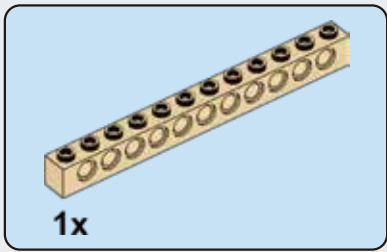

## A102

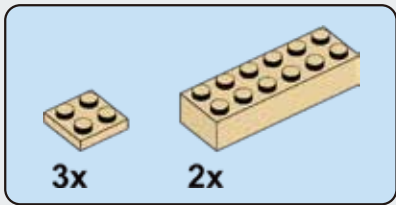
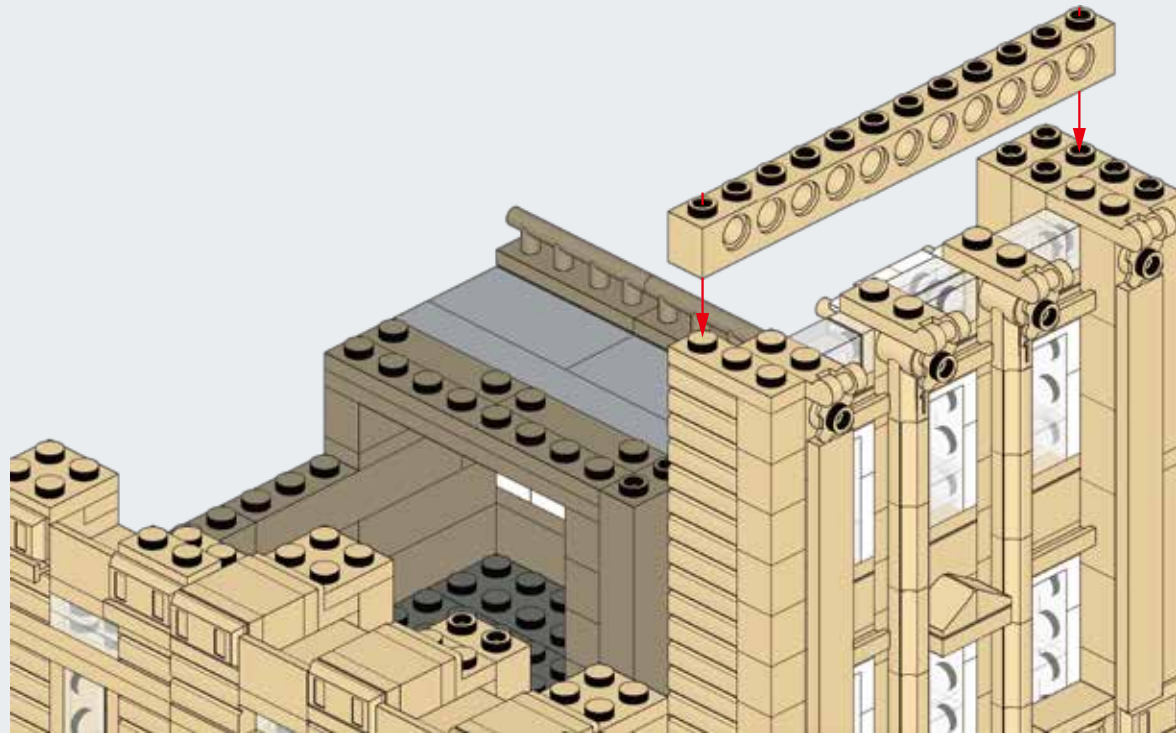

## A103

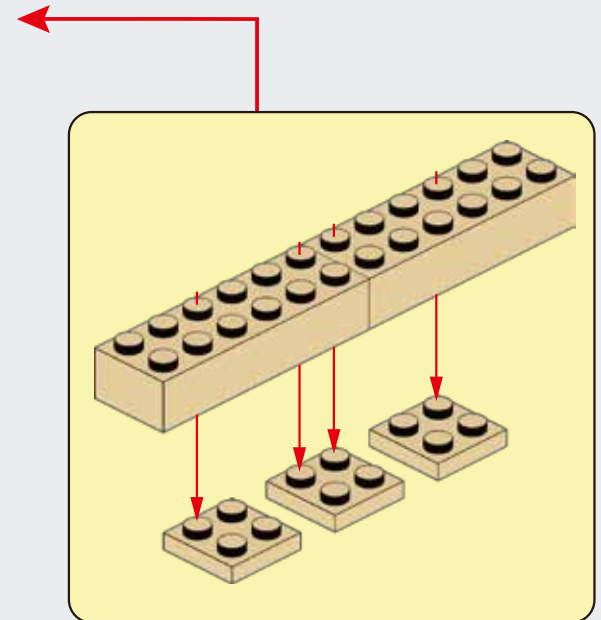
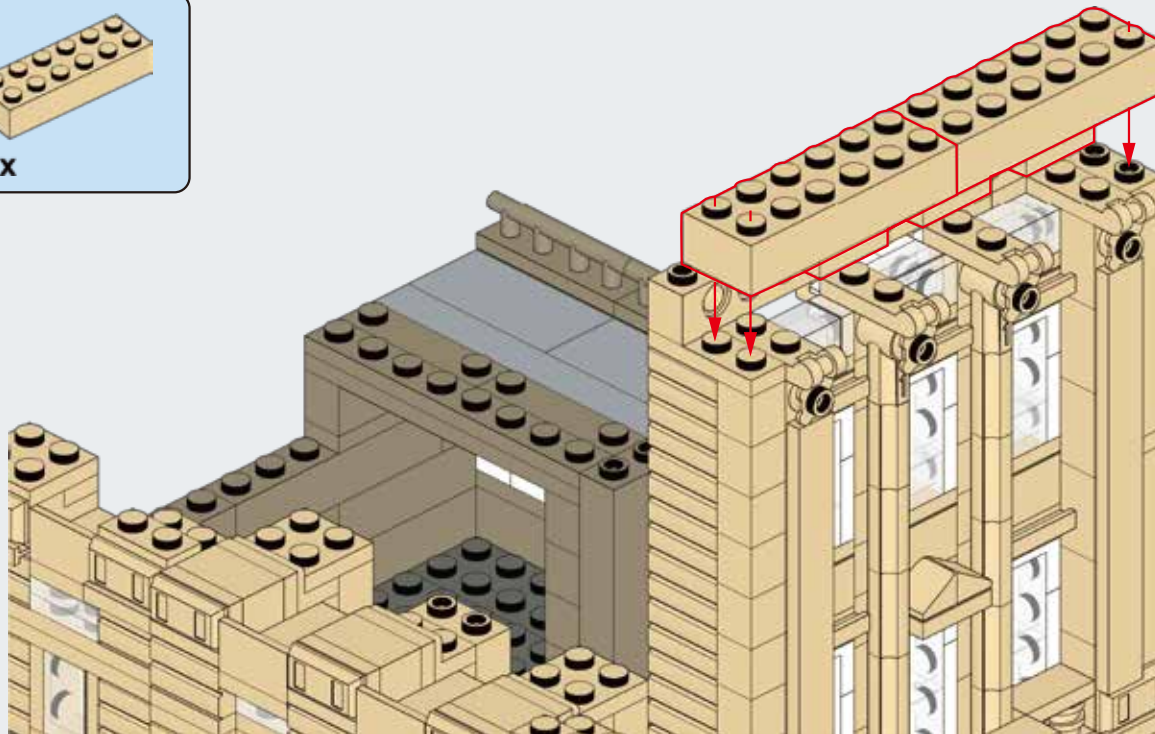

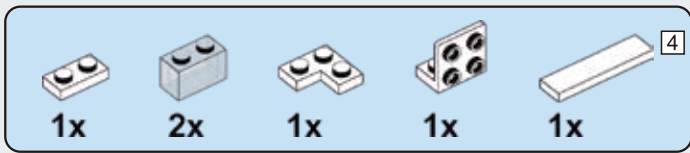

### A104

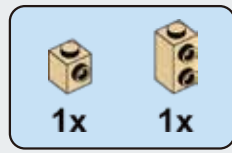
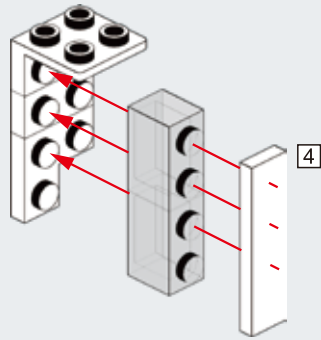

### A105

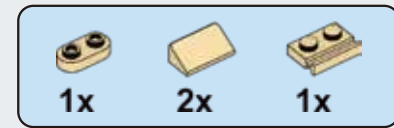
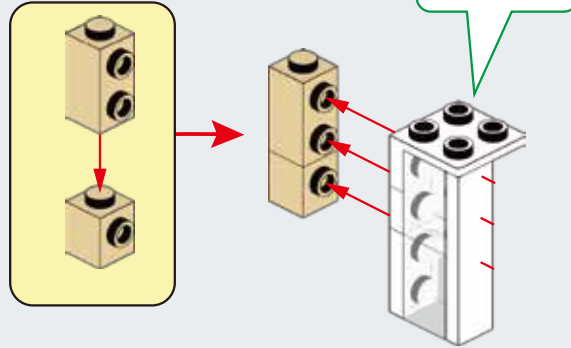

### A106

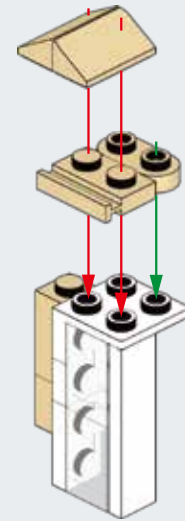

### A107

A103 →

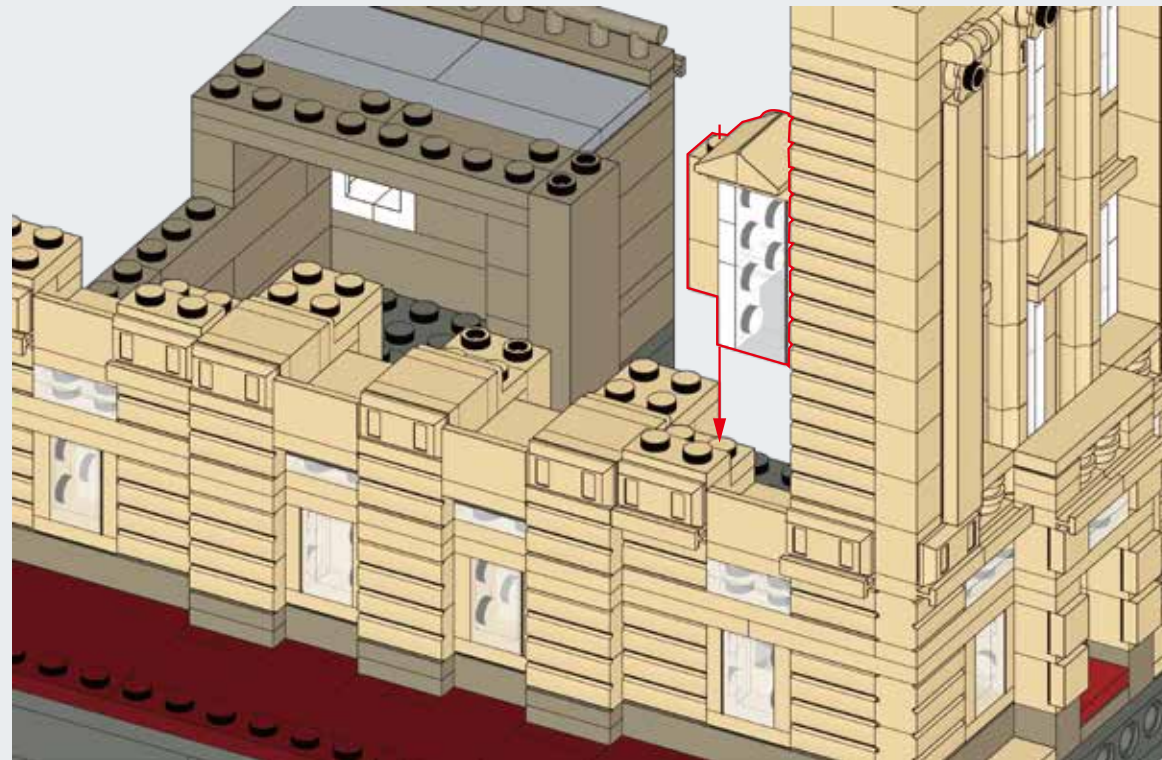



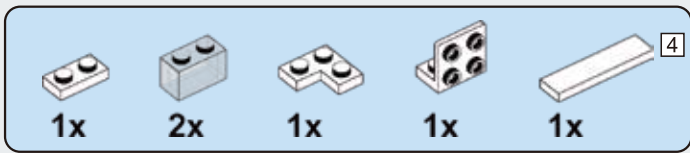

### A108

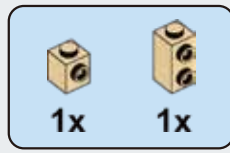
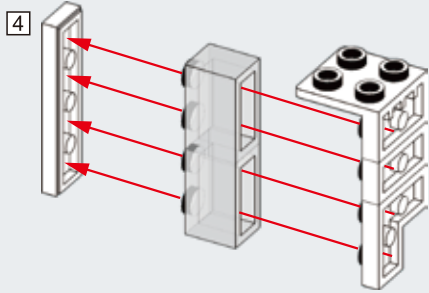

### A109

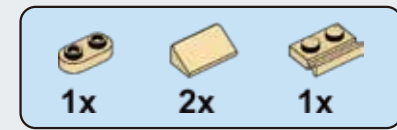
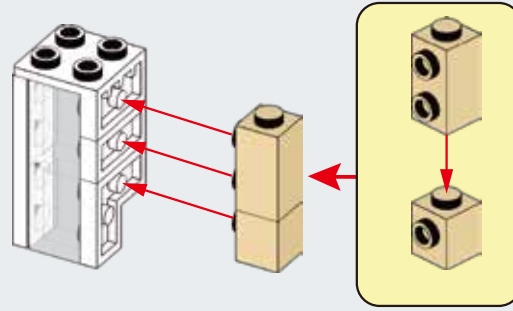

### A110

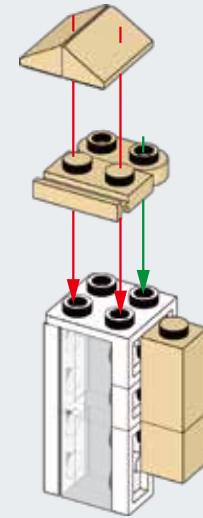

### A111

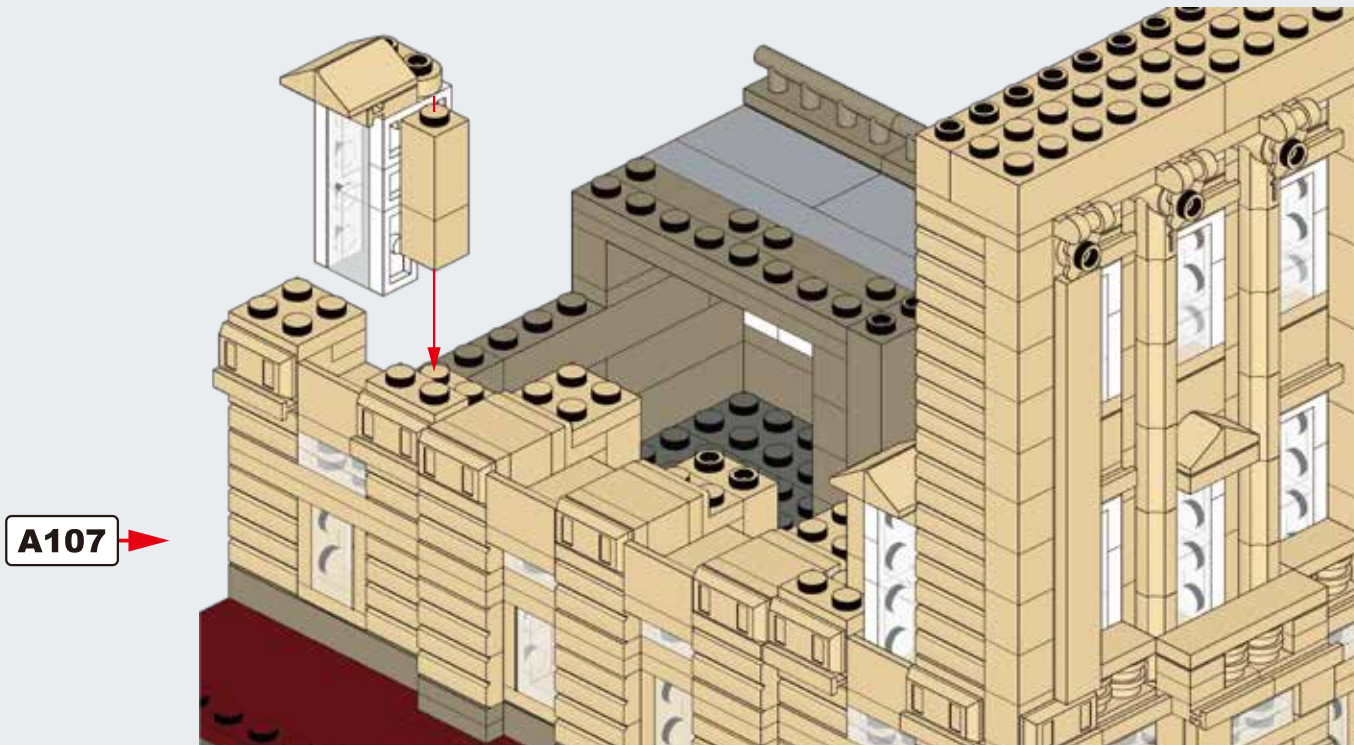



**A112**

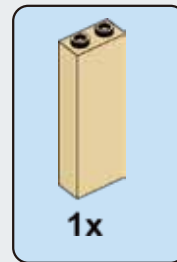
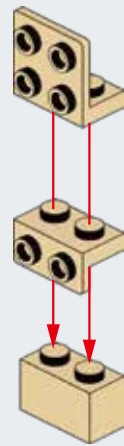

**A113**



**A114**

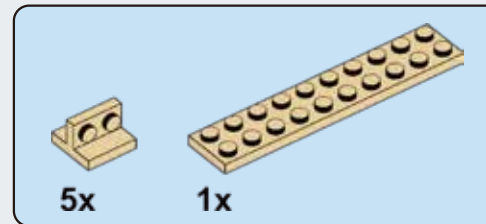
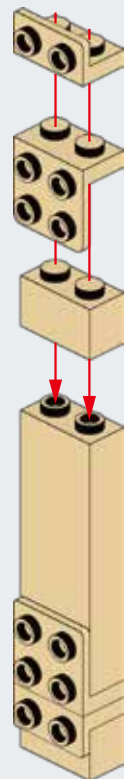

**A115**

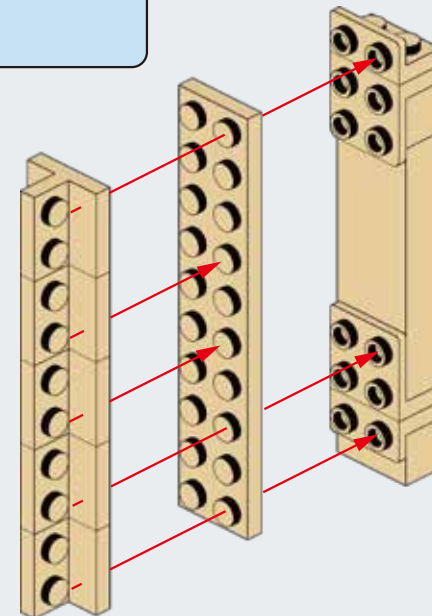

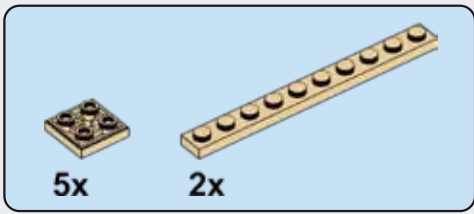

**A116**

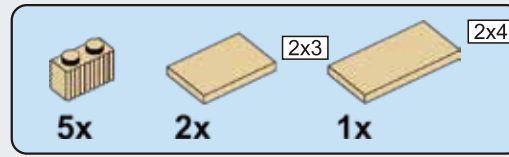
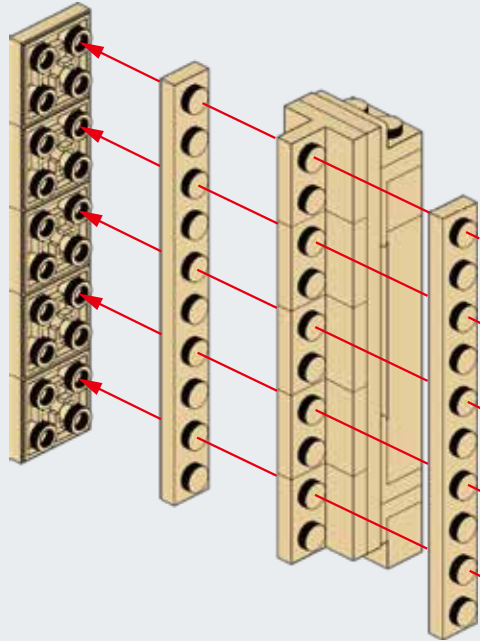

**A117**

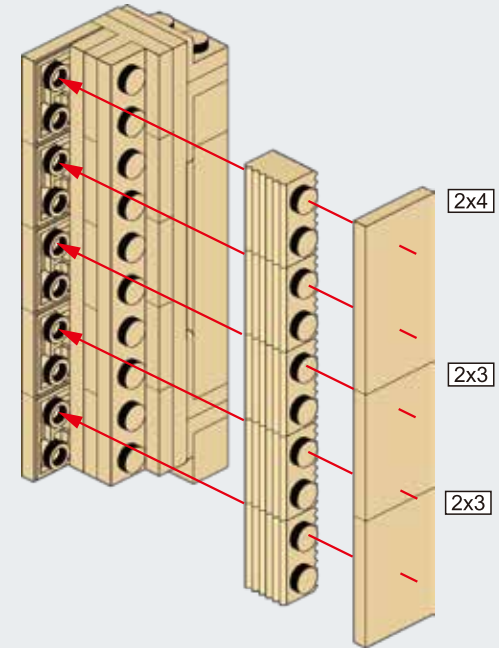

**A118**

**A111** →

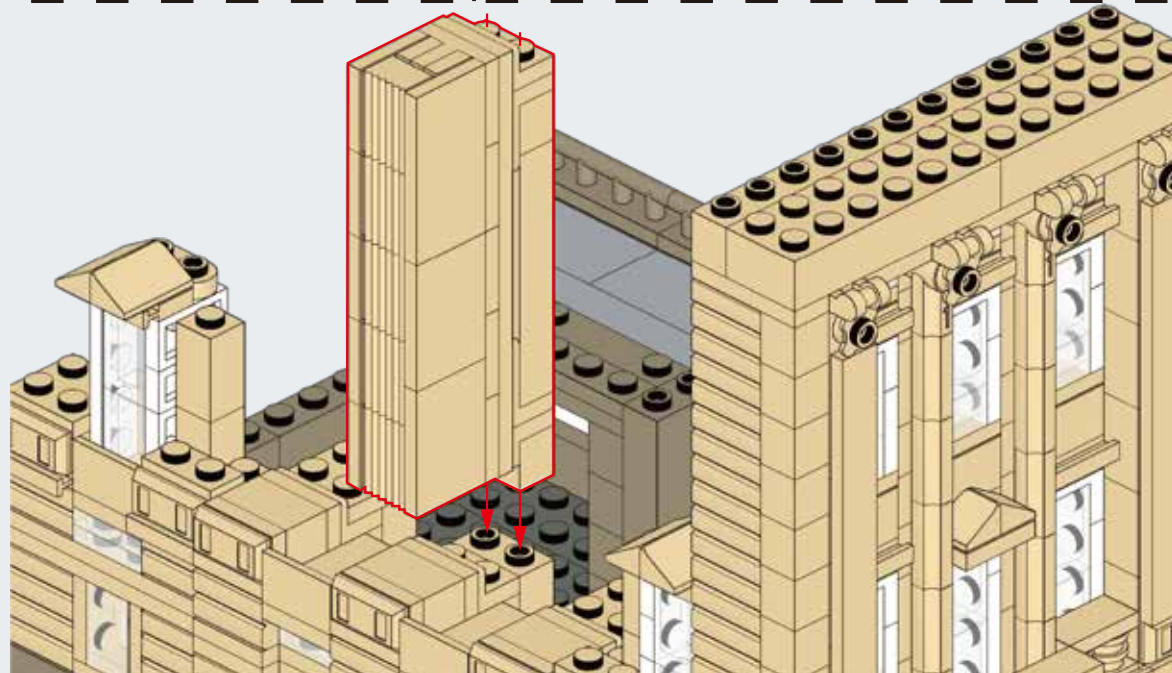

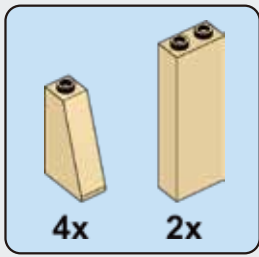

**A119**

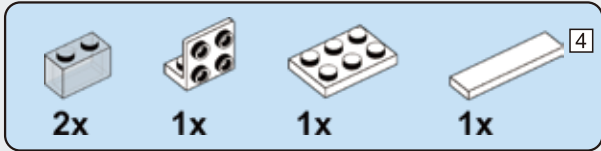
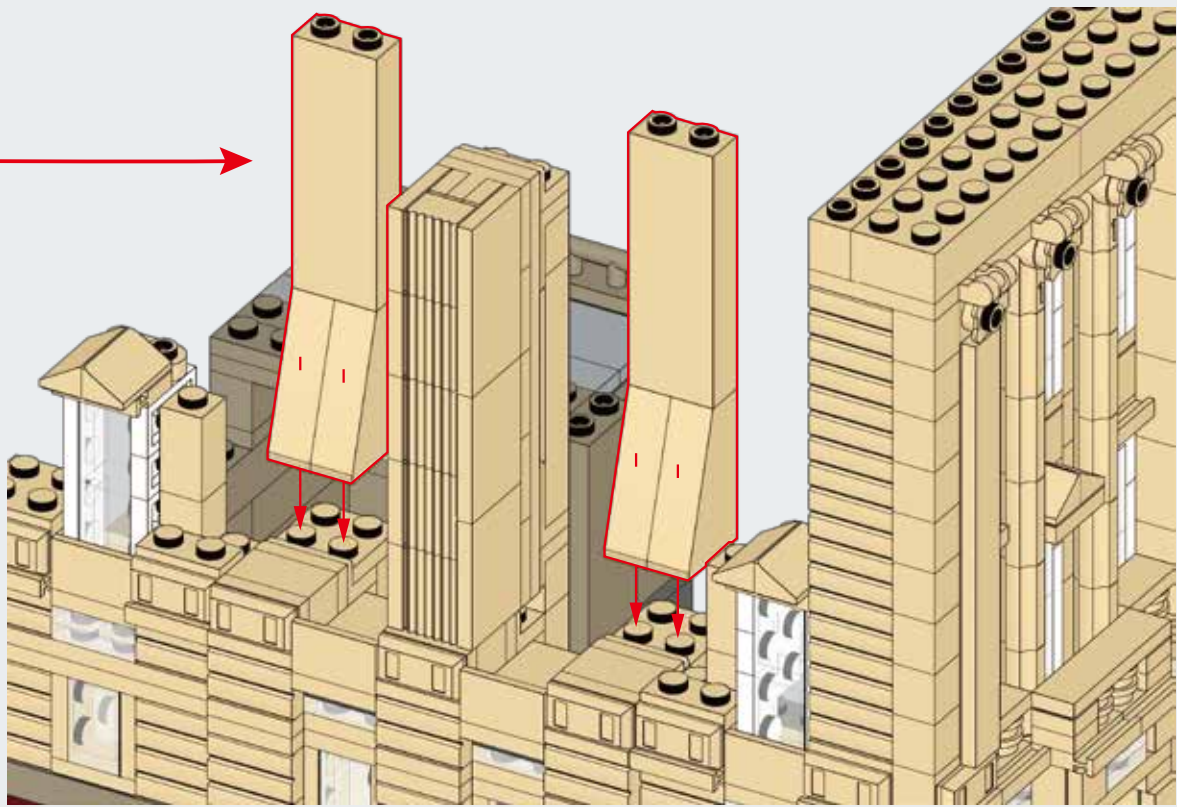
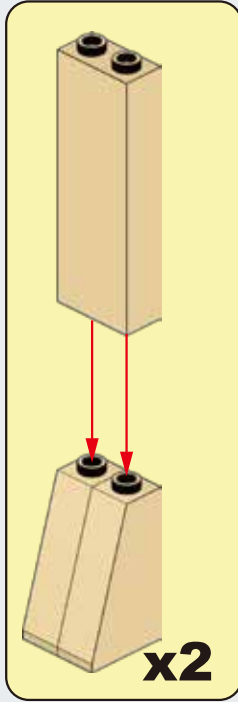

**A120**

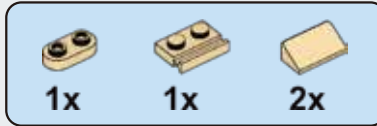
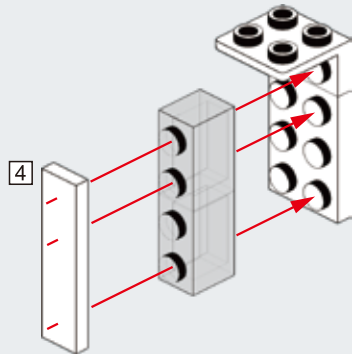

**A121**

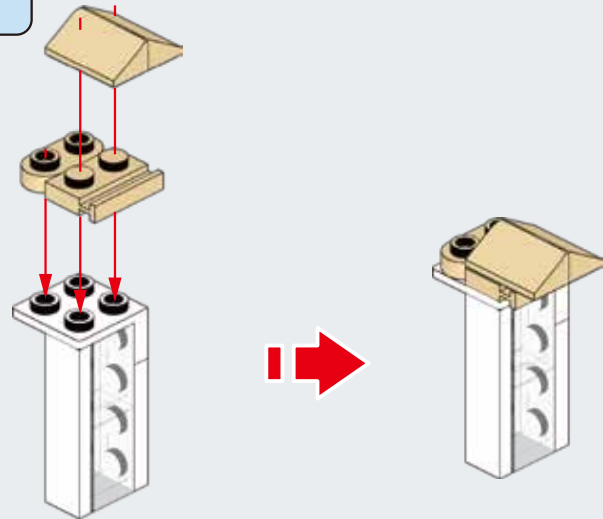

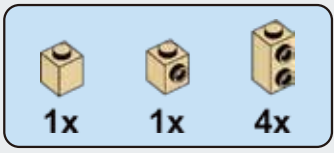

## A122

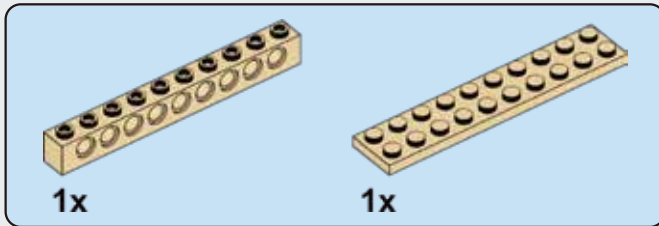
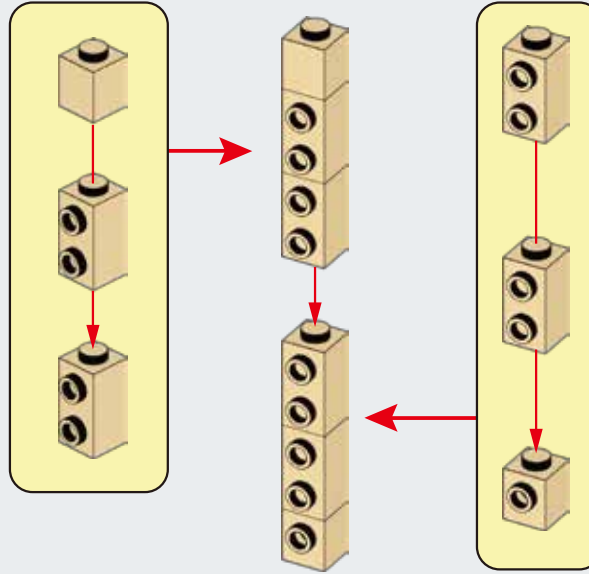

## A123

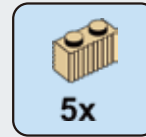
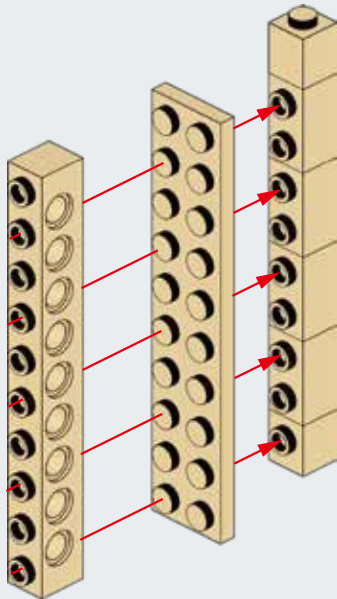

## A124

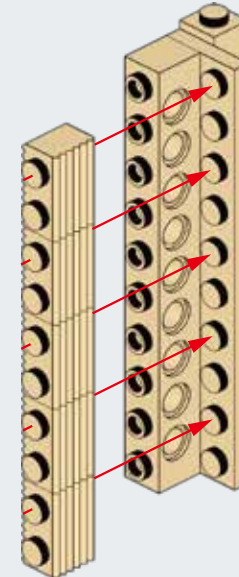

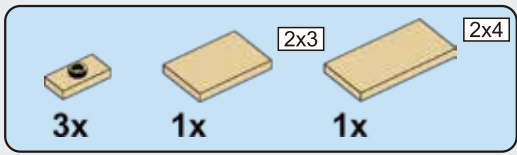

### A125

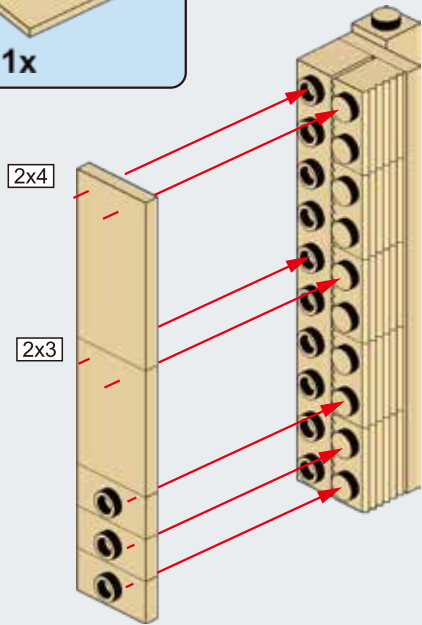

### A126

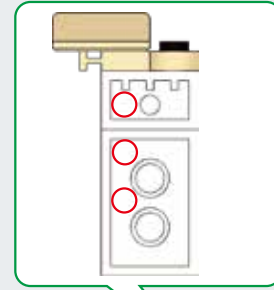

### A121

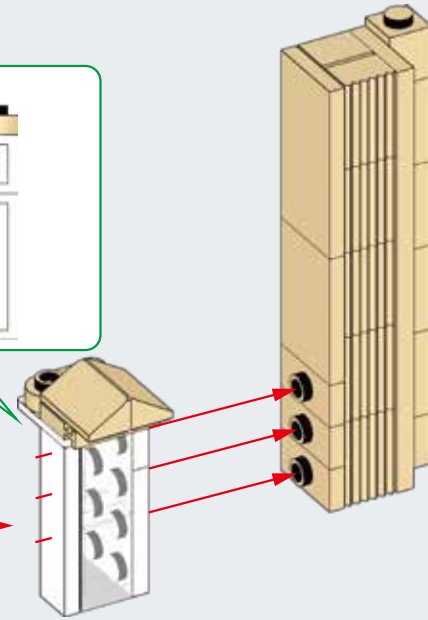

### A127

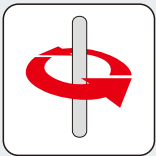

### A119

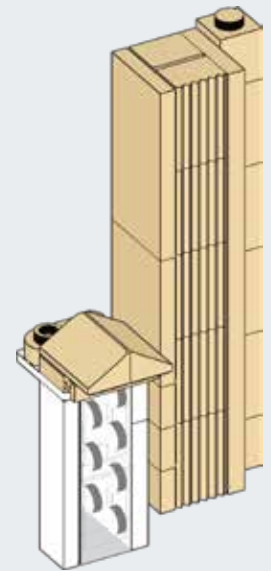
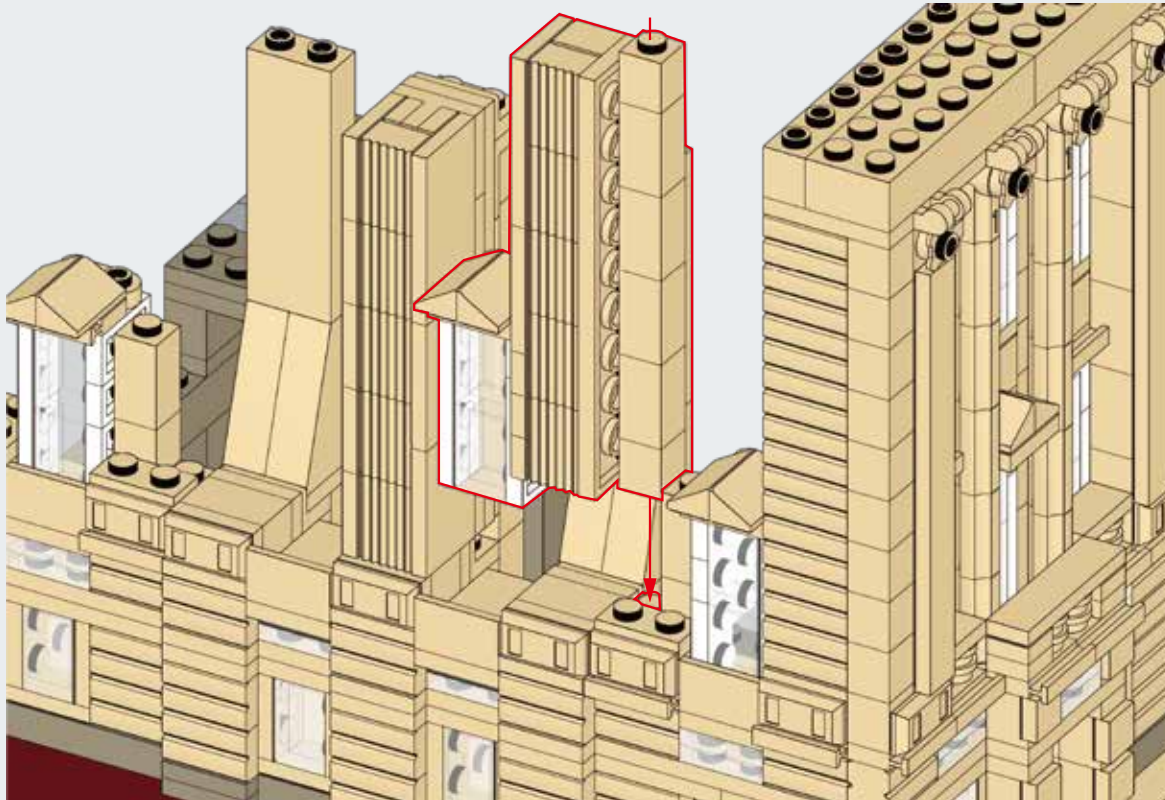

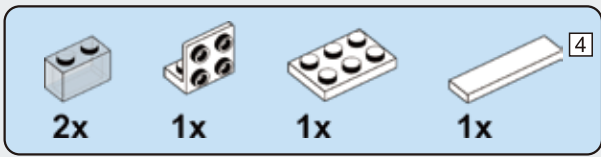

### A128

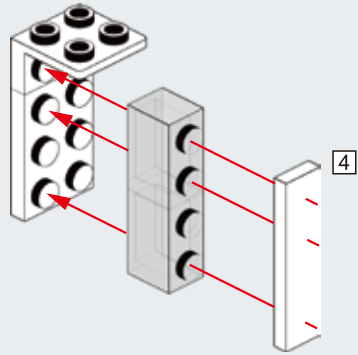

### A129

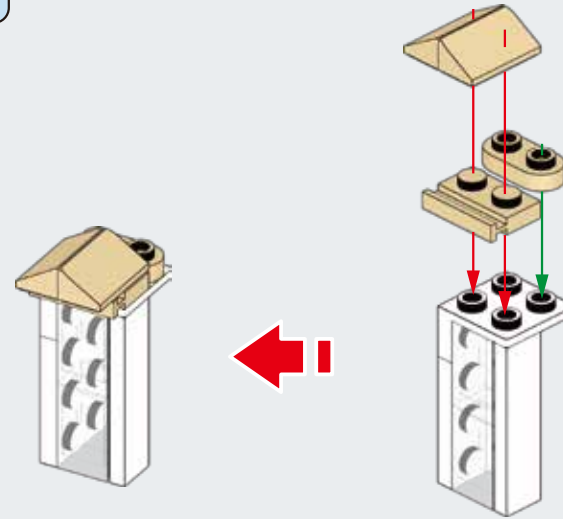

### A130

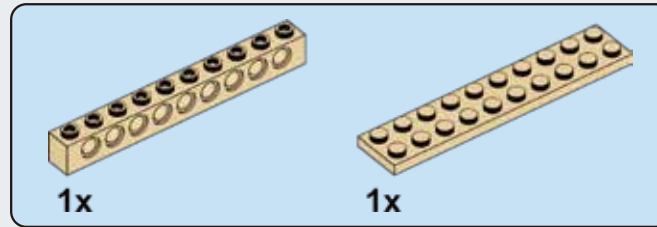
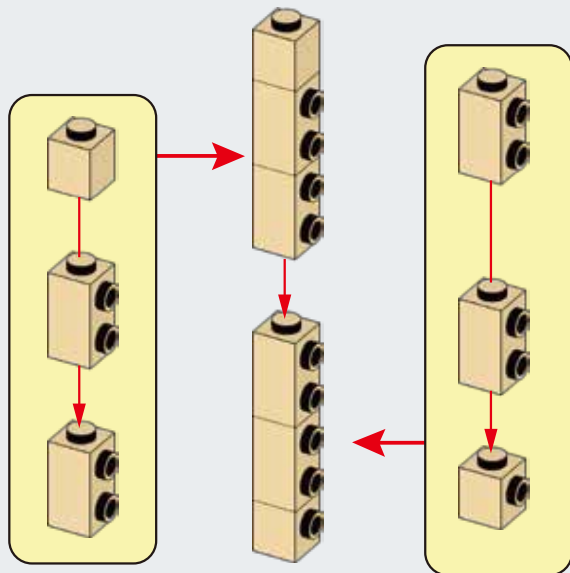

### A131

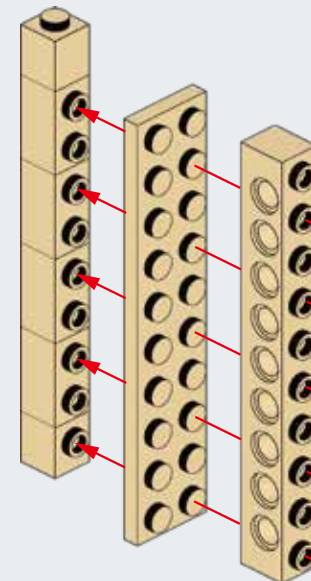



**A132**

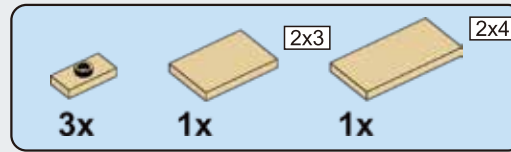
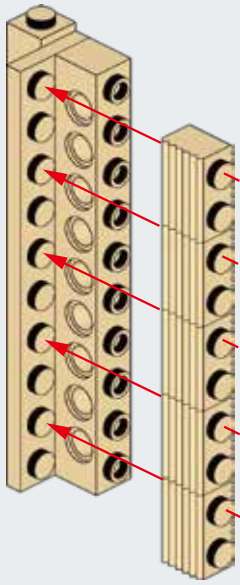

**A133**

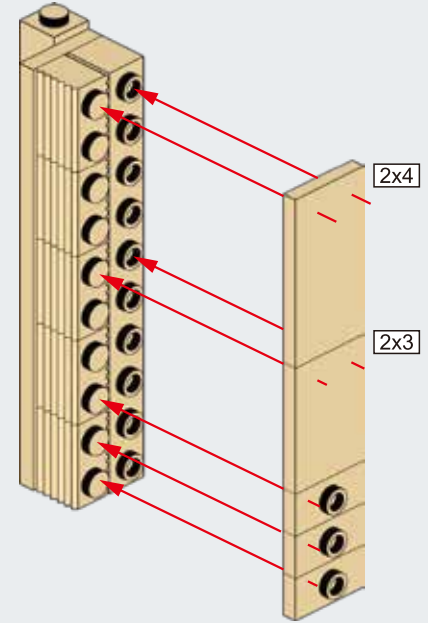

**A134**

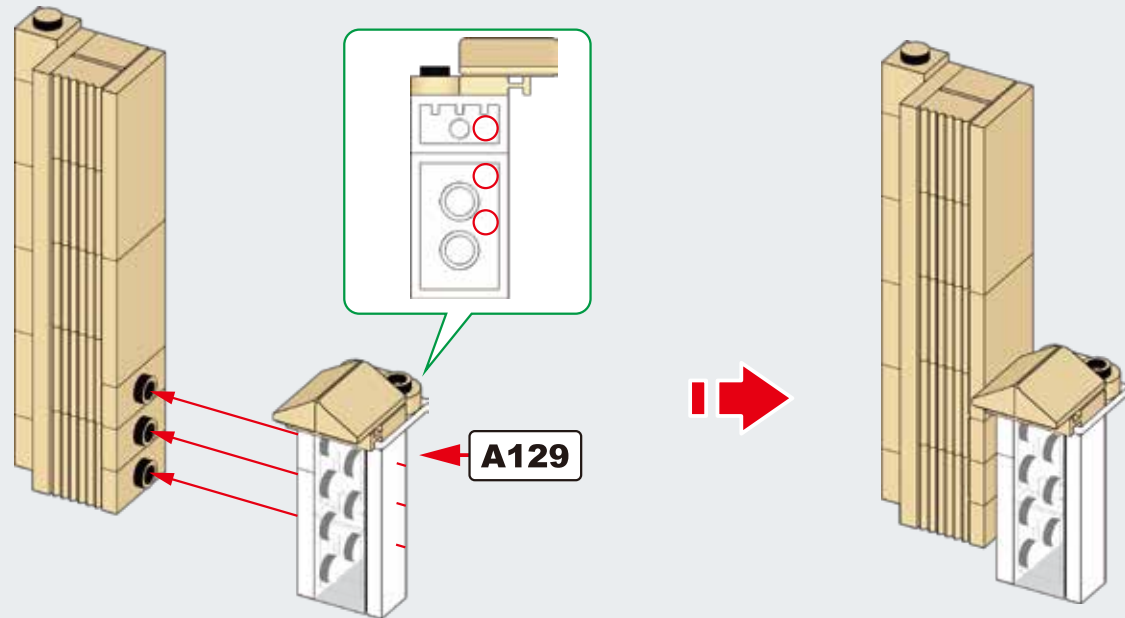



# A135

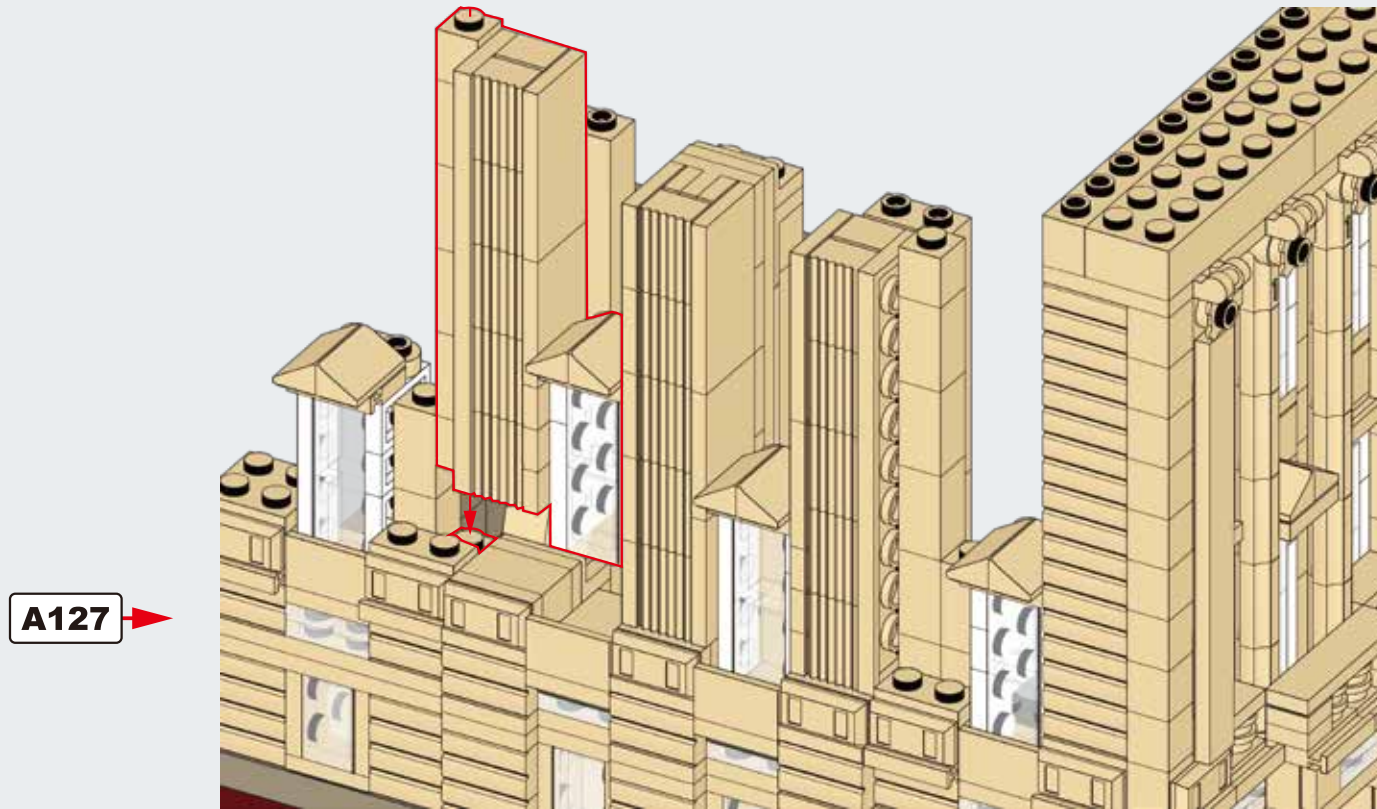

27x

# A136

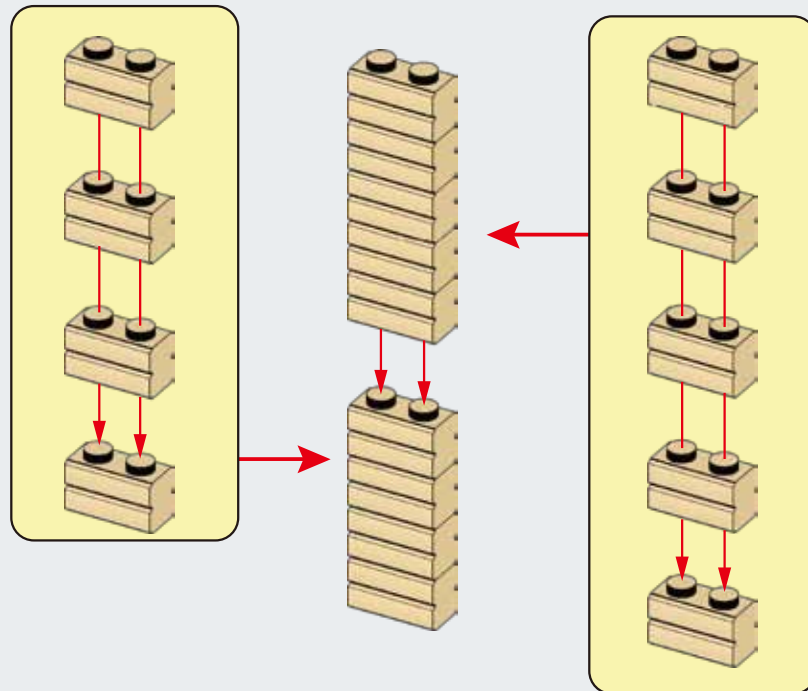

x3

**A137**

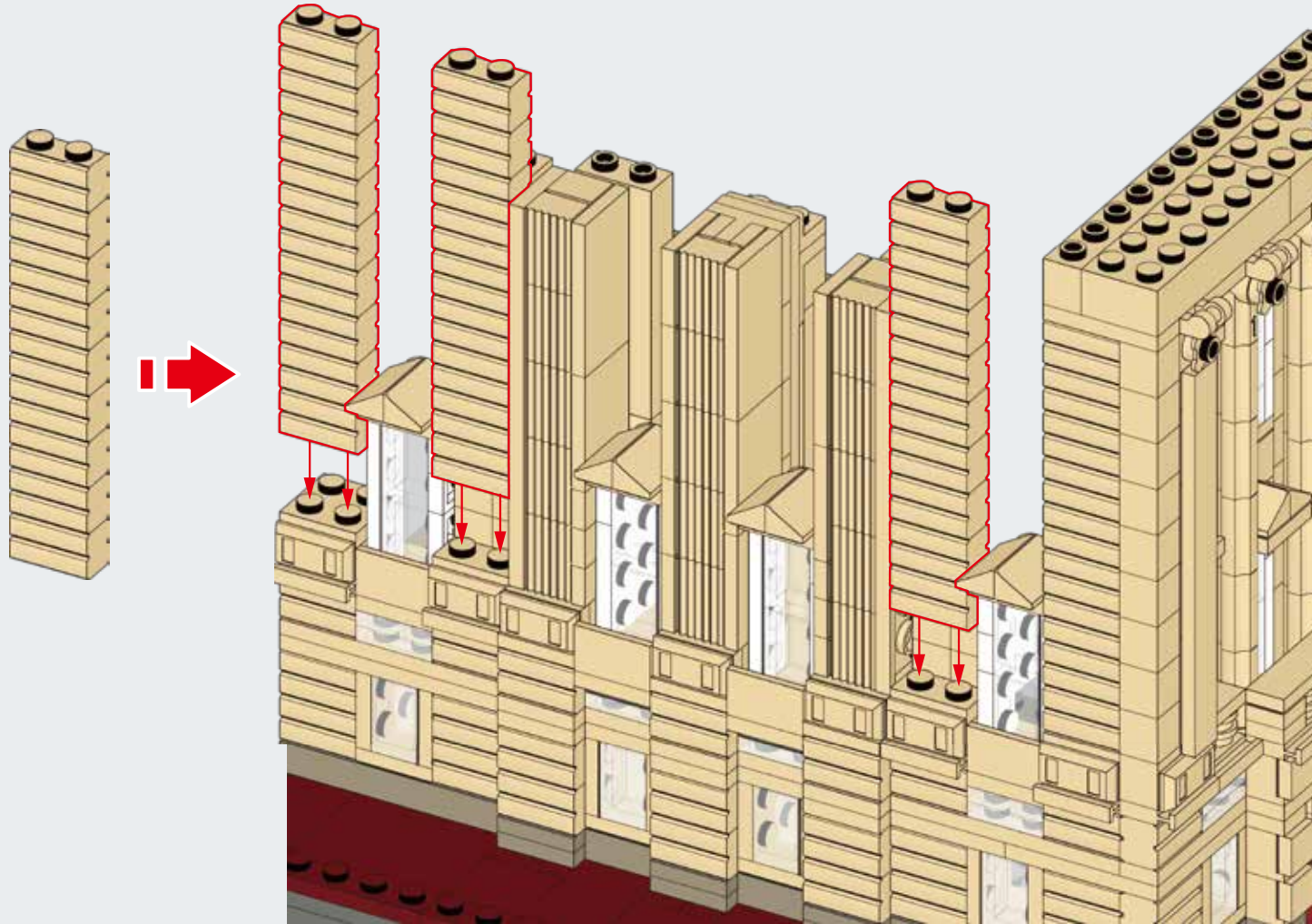

**A135**



Buckingham Palace



Please download the building instruction from below website.

[en.doubleeagle-group.com](http://en.doubleeagle-group.com)

403ARC615010001

C61501

5604PCS

Designer: Tobias Thieme