

APS LITE GYRO INSTRUCTION MANUAL 使用說明書

ALIGN

HEGAPS03T



APS

For 3GX Flybarless System

ALIGN APS LITE GYRO provides high safety switchable duo-independent control-support device. Easy to switch between manually control or Autonomous GPS assisted control flight.

亞拓APS LITE 陀螺儀具備有高安全性可手動、全自動，隨意可切換接管飛行模式的雙獨立、全方位GPS輔助控制電子裝置。

- **Supports GS800 gimbal control system**
支援GS800雲台控制系統
- **Semi-autonomous takeoff / Landing**
半自動起飛/降落
- **GPS position attitude hold**
GPS 定位與姿態保持
- **Automatic return home**
自動返航
- **Emergency bailout stabilization**
緊急姿態平衡
- **Failsafe: Automatic return home during loss of signal situation**
失控保護
- **Simple logical setting through transmitter**
遙控器簡易人性化設定
- **Supports software upgrades**
支援系統升級



TABLE OF CONTENTS

目錄

ALIGN

INTRODUCTION

前言.....	1
WARNING LABEL LEGEND 標誌代表涵義.....	1
IMPORTANT NOTES 重要聲明.....	2

SAFETY NOTES

安全注意事項.....	2
-------------	---

EQUIPMENT REQUIRED FOR ASSEMBLY

自備設備.....	5
RADIO TRANSMITTER AND ELECTRONIC EQUIPMENT REQUIRED FOR ASSEMBLY 自備遙控及電子設備.....	5
ADDITIONAL TOOLS REQUIRED FOR ASSEMBLY 自備工具.....	5

PACKAGE CONTENTS

包裝說明.....	6
STANDARD EQUIPMENT 標準配備.....	6

FEATURES

產品特色.....	7
-----------	---

APS LITE GYRO PARTS IDENTIFICATION AND INSTALLATION APS LITE 陀螺儀各部位名稱及安裝說明.....

APS LITE GYRO SETUP INDICATORS APS LITE 陀螺儀各部位名稱.....	8
APS LITE CONTROLLER APS LITE 控制器.....	8
APS SENSOR APS 感應器.....	8
CONNECTION METHOD 接線方式.....	9
APS LITE CONTROLLER SETUP INDICATORS APS LITE 控制器功能設定指示燈說明.....	9

APS LITE GYRO INSTALLATION APS LITE 陀螺儀安裝.....

APS LITE CONTROL UNIT INSTALLATION PRECAUTIONS APS LITE 控制器安裝注意事項.....	10
--	----

ELECTRIC HELICOPTER (LOW VIBRATION) INSTALLATION 電動直昇機（低震動）安裝方式.....	10
--	----

NITRO HELICOPTER (HIGHER VIBRATION) INSTALLATION 引擎直昇機（較高震動）安裝方式.....	11
---	----

APS SENSOR INSTALLATION PRECAUTIONS APS 感應器安裝注意事項.....	11
---	----

APS SENSOR INSTALLATION METHOD APS 感應器安裝方式.....	12
--	----

APS LITE GYRO AND 3GX ILLUSTRATION APS LITE 陀螺儀與3GX 配置圖示.....	13
--	----

3GX SETTINGS

3GX 設定.....	13
-------------	----

CONFIRM 3GX VERSION 確認3GX版本.....	13
-------------------------------------	----

3GX CONNECTIVITY METHOD 3GX 接線方式.....	14
--	----

METHOD 1: STANDARD RECEIVER CONNECTIVITY METHOD 方式一：傳統接收器接線法.....	14
---	----

METHOD 2: FUTABA S.BUS CONNECTIVITY METHOD 方式二：FUTABA S.BUS接線法.....	15
---	----

METHOD 3: JR/SPEKTRUM SATELLITE CONNECTIVITY METHOD 方式三：JR/SPEKTRUM衛星天線接線法.....	16
---	----

FAILSAFE (PRE-SET POSITION HOLD) 失控保護（回復預設值）.....	17
--	----

3GX SETTING PROCEDURE 3GX 設定流程.....	18
--	----

3GX BASIC SETTINGS 3GX 基本機體設定.....	19
---------------------------------------	----

RUDDER GYRO SETUP 尾舵陀螺儀設定.....	20
-----------------------------------	----

PRECAUTIONS FOR 3GX UPDATING TO V3.1 OR HIGHER 3GX更新3.1以上版本注意事項.....	21
--	----

SERVO CHANNEL LAYOUT DIAGRAM 伺服器安裝位置圖.....	21
---	----

SETTING CYCLIC PITCH TO 8 DEGREES 設定循環螺距8度.....	21
--	----

ANTI TORQUE COMPENSATION DIRECTION SETTING 反扭力補償正反向設定.....	22
--	----

TABLE OF CONTENTS

目錄

ALIGN

3GX THROTTLE RANGE CALIBRATION 3GX 油門行程校正.....	23	APS FLIGHT MODE APS 飛行模式.....	39
RC TRANSMITTER SETUP 遙控器設定.....	24	SEMI-AUTONOMOUS TAKEOFF 半自動起飛.....	40
TRANSMITTER SWITCH SETTING 遙控器開關設定.....	24	SEMI-AUTONOMOUS LANDING 半自動降落.....	40
APS LITE CONTROL MODES SETTINGS APS LITE 操作模式設定.....	24	GPS POSITION ATTITUDE HOLD GPS 定位與姿態保持.....	41
APS LITE SWITCH CONFIGURATION APS LITE 開關配置.....	25	EMERGENCY BAILOUT 緊急姿態平衡.....	41
STATUS LIGHT INSTRUCTION 狀態指示燈說明.....	26	DESCEND DECELERATION SYSTEM 降落自動減速功能.....	43
GPS FLIGHT MODE COMMAND CHECK GPS 飛行模式指令檢查.....	26	GPS FLIGHT MODE GPS 飛行模式.....	44
THROTTLE/ PITCH CURVE SETTING 油門螺距曲線設定.....	27	RETURN HOME 自動返航Home點.....	45
FAILSAFE PROTECTION SETTINGS 失控保護設定.....	28	FAILSAFE PROTECTION 失控保護.....	46
CALIBRATION BEFORE FLIGHT 飛行前校正.....	29	APS LITE CONTROL UNIT LED DISPLAY APS LITE 控制器指示燈說明.....	46
MAGNETOMETER CALIBRATION 磁力計校正.....	29	APS LITE WORKING MODE APS LITE 工作模式.....	46
VIBRATION TEST 震動測試.....	31	CALIBRATION MODE 磁力計校正模式.....	47
PRE-FLIGHT CHECK 飛行前檢查.....	33	VIBRATION TEST MODE 震動測試模式.....	47
SENSITIVITY SETTINGS 感度旋鈕設定.....	35	UPDATE MODE 更新模式.....	47
ATTITUDE GAIN AND LEVEL GAIN ADJUSTMENT 姿態感度和水平位置感度調整.....	35	SPECIFICATIONS 產品規格.....	47
VERTICAL POSITION GAIN SETTING 垂直位置感度調整.....	35	Q & A 問與答.....	48
CONTROL FEEL ADJUSTMENT UNDER APS MODE APS 模式操控手感調整.....	36		
HEADING DIRECTION GAIN ADJUSTMENT 頭向感度調整功能頭向感度調整功能.....	37		
CONTROL MODES 操作模式.....	38		

INTRODUCTION

前言

ALIGN

Thank you for buying ALIGN products. Before entering RC world, there are something you need to know and pay attention with to make sure have a smooth learning process.

For make feel easy to use the APS LITE gyro, please read through this manual prior to install and configure the APS LITE gyro, and keep this manual handy for future reference.

APS LITE gyro is an electronic flight augmentation device, and can only function when used with ALIGN's 3GX flybarless system. With APS LITE gyro installed, the helicopter will have the ability to self stabilize, hold position as well as altitude, and even automatic return home. It is the perfect tool for flight training, as well as aerial photography applications.

承蒙閣下選用亞拓遙控世界系列產品，謹表謝意。進入遙控世界之前必須告訴您許多相關的知識與注意事項，以確保您能夠在學習的過程中較得心應手。

為了讓您容易方便使用APS LITE 陀螺儀，在開始操作之前，請您詳細的閱讀完這本說明書之後再進行安裝與設定，同時請您妥善保存這本說明書，作為爾後調整的參考。

APS LITE 陀螺儀是輔助直昇機飛行的電子裝置，它必須搭配亞拓3GX無平衡翼系統才能運作使用。裝上ASP LITE 陀螺儀可以讓您的直昇機發揮更多的功能，它可以幫助您讓直昇機自動穩定、定位、定高度的停懸飛行，自動返航等功能，它將是您學習直昇機、甚至空中攝影作業...等的完美輔助飛行工具。

WARNING LABEL LEGEND

標誌代表涵義

 FORBIDDEN 禁止	Do not attempt under any circumstances. 在任何禁止的環境下，請勿嘗試操作。
 WARNING 警告	Mishandling due to failure to follow these instructions may result in damage or injury. 因為疏忽這些操作說明，而使用錯誤可能造成財產損失或嚴重傷害。
 CAUTION 注意	Mishandling due to failure to follow these instructions may result in danger. 因為疏忽這些操作說明，而使用錯誤可能造成危險。

IMPORTANT NOTES

重要聲明

R/C helicopters, are not toys. R/C helicopter utilize various high-tech products and technologies to provide superior performance. Improper use of this product can result in serious injury or even death. Please read this manual carefully before using and make sure to be conscious of your own personal safety and the safety of others and your environment when operating all ALIGN products. Manufacturer and seller assume no liability for the operation or the use of this product. This product is intended for use only by adults with experience flying remote control helicopters at a legal flying field. After the sale of this product we cannot maintain any control over its operation or usage.

遙控直昇機並非玩具，它是結合了許多高科技產品所設計出來的休閒用品，所以商品的使用不當或不熟悉都可能造成嚴重傷害甚至死亡，使用之前請務必詳讀本說明書，勿輕忽並注意自身安全。注意！任何遙控直昇機的使用，製造商和經銷商是無法對使用者於零件使用的損耗異常或組裝不當所發生之意外負任何責任，本產品是提供給有操作過模型直昇機經驗的成人或有相當技術的人員在旁指導於當地合法遙控飛行場飛行，以確保安全無虞下操作使用，產品售出後本公司將不負任何操作和使用控制上的任何性能與安全責任。

As the user of this product, you are solely responsible for operating it in a manner that does not endanger yourself and others or result in damage to the product or the property of others.

做為本產品的使用者，您，是唯一對於您自己操作的環境及行為負全部的責任之人。

We recommend that you obtain the assistance of an experienced pilot before attempting to fly our products for the first time. A local expert is the best way to properly assemble, setup, and fly your model for the first time. The requires a certain degree of skill to operate, and is a consumer item. Any damage or dissatisfaction as a result of accidents or modifications are not covered by any warrantee and cannot be returned for repair or replacement. Please contact our distributors for free technical consultation and parts at discounted rates when you experience problems during operation or maintenance. As Align Corporation Limited has no control over use, setup, final assembly, modification or misuse, no liability shall be assumed nor accepted for any resulting damage or injury. By the act of use, setup or assembly, the user accepts all resulting liability.

模型商品屬於需高操作技術且為消耗性之商品，如經拆裝使用後，會造成不等情況零件損耗，任何使用情況所造成商品不良或不滿意，將無法於保固條件內更換新品或退貨，如遇有使用操作維修問題，本公司全省分公司或代理商將提供技術指導、特價零件供應服務。對使用者的不當使用、設定、組裝、修改、或操作不良所造成的破損或傷害，本公司無法控制及負責。任何使用、設定、組裝、修改、或操作不良所造成的破損、意外或傷害，使用者應承擔全部責任。

SAFETY NOTES

安全注意事項

ALIGN

- Fly only in safe areas, away from other people. Do not operate R/C aircraft within the vicinity of homes or crowds of people. R/C aircraft are prone to accidents, failures, and crashes due to a variety of reasons including, lack of maintenance, pilot error, and radio interference. Pilots are responsible for their actions and damage or injury occurring during the operation or as of a result of R/C aircraft models.
- Prior to every flight, carefully check rotorhead spindle shaft screws and tail blade grip screws, linkage balls and screws, ensure they are firmly secured.
- 遙控模型飛機、直昇機屬高危險性商品，飛行時務必遠離人群，人為組裝不當或機件損壞、電子控制設備不良，以及操控上的不熟悉、都有可能導致飛行失控損傷等不可預期的意外，請飛行者務必注意飛行安全，並需了解自負疏忽所造成任何意外之責任。
- 每趟飛行前須仔細檢查，主旋翼夾座橫軸螺絲、尾旋翼夾座螺絲，以及機身各部位球頭、螺絲，確實上膠鎖緊才能昇空飛行。



LOCATE AN APPROPRIATE LOCATION

遠離障礙物及人群

R/C helicopters fly at high speed, thus posing a certain degree of potential danger. Choose a legal flying field consisting of flat, smooth ground without obstacles. Do not fly near buildings, high voltage cables, or trees to ensure the safety of yourself, others and your model. For the first practice, please choose a legal flying field.

Do not fly your model in inclement weather, such as rain, wind, snow or darkness.

直昇機飛行時具有一定的速度，相對的也潛在著危險性，場地的選擇也相對的重要，請需遵守當地法規到合法遙控飛行場地飛行。必須注意周遭有沒有人、高樓、建築物、高壓電線、樹木等等，避免操控的不當造成自己與他人財產的損壞。初次練習時，務必選擇在空曠合法專屬飛行場地並適當搭配練習架練習飛行，這對飛行失誤所造成的損傷將會大幅的降低。

請勿在下雨、打雷等惡劣天候下操作，以確保本身及機體的安全。



NOTE ON LITHIUM POLYMER BATTERIES

鋰聚電池注意事項

Lithium Polymer batteries are significantly more volatile than alkaline or Ni-Cd/Ni-MH batteries used in RC applications. All manufacturer's instructions and warnings must be followed closely. Mishandling of Li-Po batteries can result in fire. Always follow the manufacturer's instructions when disposing of Lithium Polymer batteries.

鋰聚電池跟一般在RC使用的鹼性電池、鎳鎘電池、鎳氫電池比較起來是相對危險的。請嚴格遵守鋰聚電池說明書之使用注意事項。不恰當使用鋰聚電池，可能造成火災並傷及生命財產安全，切勿大意！

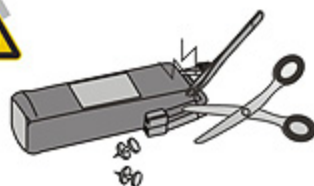

PREVENT MOISTURE

遠離潮濕環境

R/C models are composed of many precision electrical components. It is critical to keep the model and associated equipment away from moisture and other contaminants. The introduction or exposure to water or moisture in any form can cause the model to malfunction resulting in loss of use, or a crash. Do not operate or expose to rain or moisture.

直昇機內部也是由許多精密的電子零組件組成，所以必須絕對的防止潮濕或水氣，避免在浴室或雨天時使用，防止水氣進入機身內部而導致機件及電子零件故障而引發不可預期的意外！

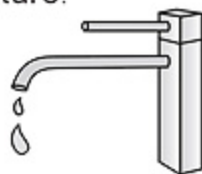

PROPER OPERATION

勿不當使用本產品

Please use the replacement of parts on the manual to ensure the safety of instructors. This product is for R/C model, so do not use for other purpose.

請勿自行改造加工，任何的升級改裝或維修，請使用亞拓產品目錄中的零件，以確保結構的安全。請確認於產品限界內操作，請勿過載使用，並勿用於安全、法令外其它非法用途。





WARNING 警告

OBTAIN THE ASSISTANCE OF AN EXPERIENCED PILOT 避免獨自操控

Before turning on your model and transmitter, check to make sure no one else is operating on the same frequency. Frequency interference can cause your model, or other models to crash. The guidance provided by an experienced pilot will be invaluable for the assembly, tuning, trimming, and actual first flight or unforeseen danger may happen. (Recommend you to practice with computer-based flight simulator.)

至飛行場飛行前，需確認是否有相同頻率的同好正進行飛行，因為開啓相同頻率的發射機將導致自己與他人立即干擾等意外危險。遙控飛機操控技巧在學習初期有著一定的難度，要盡量避免獨自操作飛行，需有經驗的人士在旁指導，才可以操控飛行，否則將可能造成不可預期的意外發生。(勤練電腦模擬器及老手指導是入門必要的選擇)



WARNING 警告

SAFE OPERATION 安全操作

Operate this unit within your ability. Do not fly under tired condition and improper operation may cause in danger. Never take your eyes off the model or leave it unattended while it is turned on. Immediately turn off the model and transmitter when you have landed the model.

請於自己能力內及需要一定技術範圍內操作這台直昇機，過於疲勞、精神不佳或不當操作，意外發生風險將可能會提高。不可在視線範圍外飛行，降落後也請馬上關掉直昇機和遙控器電源。



CAUTION 注意

ALWAYS BE AWARE OF THE ROTATING BLADES 遠離運轉中零件

During the operation of the helicopter, the main rotor and tail rotor will be spinning at a high rate of speed. The blades are capable of inflicting serious bodily injury and damage to the environment. Be conscious of your actions, and careful to keep your face, eyes, hands, and loose clothing away from the blades. Always fly the model a safe distance from yourself and others, as well as surrounding objects.

直昇機主旋翼與尾旋翼運轉時會以高轉速下進行，在高轉速下的旋翼會造成自己與他人在身體上或環境上的嚴重損傷，請勿觸摸運轉中的主旋翼與尾旋翼，並保持安全距離以避免造成危險及損壞。



CAUTION 注意

KEEP AWAY FROM HEAT 遠離熱源

R/C models are made of various forms of plastic. Plastic is very susceptible to damage or deformation due to extreme heat and cold climate. Make sure not to store the model near any source of heat such as an oven, or heater. It is best to store the model indoors, in a climate-controlled, room temperature environment.

遙控飛機、直昇機多半是以 PA 纖維或聚乙烯、電子商品為主要材質，因此要盡量遠離熱源、日曬，以避免因高溫而變形甚至熔毀損壞的可能。



EQUIPMENT REQUIRED FOR ASSEMBLY

自備設備

ALIGN

1 RADIO TRANSMITTER AND ELECTRONIC EQUIPMENT REQUIRED FOR ASSEMBLY

自備遙控及電子設備



Flybarless System Helicopters
T-REX 250 ~ T-REX 800
無平衡翼系統直昇機 T-REX 250 ~ T-REX 800



Transmitter (8-channel or more, helicopter system)
● Must have 3 step gyro gain control function and support failsafe on all channels

發射機(八動以上直昇機模式遙控器)
● 須具單獨控制尾舵感度三段開關與支援所有通道失控保護設定



3GX Flybarless System
V3.1 or higher
3GX無平衡翼系統V3.1以上



Receiver(7-channel or more)
接收器(七動以上)



Remote Receiver
衛星天線

or
或

2 ADDITIONAL TOOLS REQUIRED FOR ASSEMBLY

自備工具



Swashplate Leveler
十字盤調整器

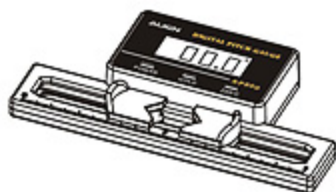

AP-800 Digital Pitch Gauge
AP-800 數位螺距規



Multi-function Tester
Voltmeter/Servo Diagnosis
多功能檢測計
電池電壓/伺服器檢測

PACKAGE CONTENTS





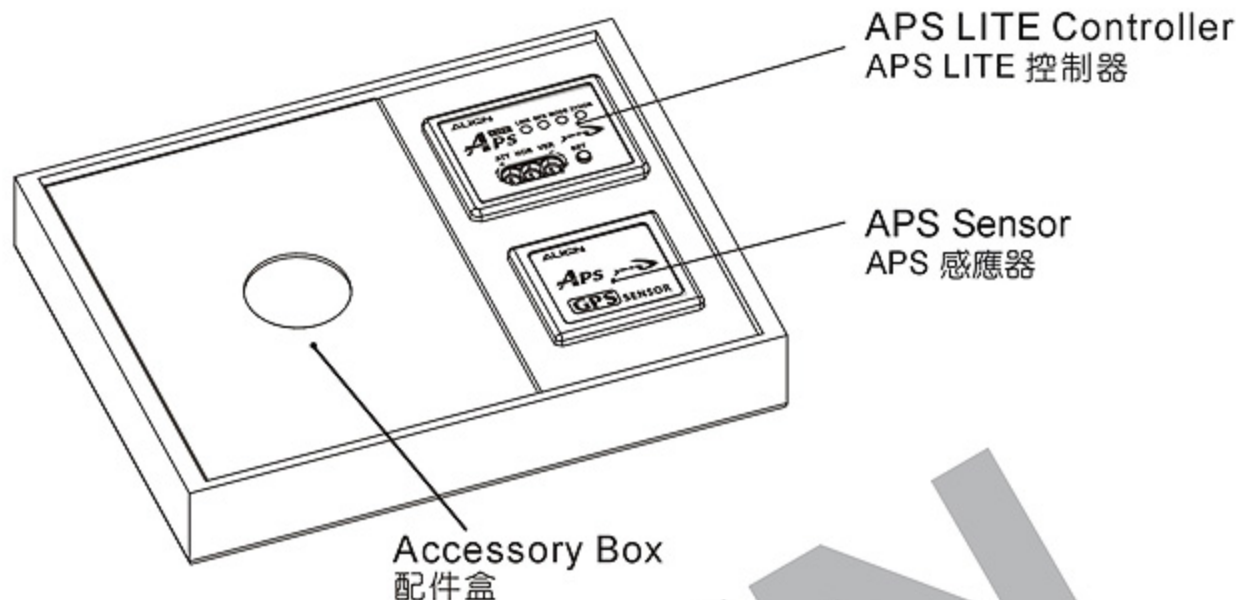







包裝說明

ALIGN



STANDARD EQUIPMENT

標準配備

 <p>APS LITE Controller x1 APS LITE 控制器 x1</p>	 <p>APS Sensor x1 APS 感應器 x1</p>	 <p>APS LITE CD ROM x1 APS LITE 光碟 x1</p>
 <p>APS Sensor Mount x1 APS 感應器座 x1</p>	 <p>APS Sensor Mounting Platform Tailboom Clamp x3 APS 感應器下座 x3</p> <p>  T3x12mm x2  T2.6x10mm x2  T2x10mm x2 </p> <p>Stainless Screw 不鏽鋼圓頭十字自攻螺絲</p>	 <p>APS Wire Assembly X 1 Set APS 線組 x1組</p>
 <p>APS Controller Metal Plate x1 APS 控制器鐵片 x1</p>	 <p>APS Controller Vibration Dampening Foam x6 APS 控制器防震泡棉 x6</p>	 <p>APS Sensor Double Sided Tape x1 APS 感應器雙面泡棉 x1</p>  <p>Plastic Flat Screwdriver x1 塑膠一字起子X1</p>

FEATURES

產品特色

ALIGN



Build in GPS sensor for precise location fixing function.
內建GPS感應器，提供精準的定位功能。

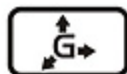

Build in 3-axis accelerometer to detect helicopter's attitude, enabling APS LITE to perform stable flight.
內建3軸加速計，可準確偵測直昇機姿態，讓APS LITE進行定點穩定飛行。



Utilizing 3-axis magnetic compass to precisely detect heading, enabling APS LITE to navigated flight.
利用3軸磁力計，可精準測量偵測直昇機機頭方向，讓APS LITE進行導航飛行。



Built in altimeter to detect altitude based on barometric pressure, allowing APS LITE to fly with fixed altitude.
內建氣壓計，藉由偵測氣壓來判別高度，並提供APS LITE定高度飛行。



Maximum altitude restriction is 400M.
APS模式飛行高度限制為400公尺。



Helicopter is capable of position hold, waypoint, altitude hold automatic hover.
直昇機可定點、定位、定高度自動停懸飛行。



Helicopter is capable of returning to user defined home position.
直昇機可自動導航飛回自行設定的HOME點位置。



Helicopter will return home position automatically when transmitter signal is lost.
當失去發射訊號時，直昇機將自動導航飛回HOME點位置。



Equipped with DSP processor to enable APS LITE to have precise detection and control abilities.
搭配DSP控制處理晶片，使APS LITE系統擁有精準感測與控制能力。



For use with Align's 3GX flybarless system with three flight mode: 3GX flight mode / APS flight mode / GPS flight mode.
搭配亞拓3GX無平衡翼系統使用，具有三種飛行模式：3GX飛行模式/APS飛行模式/GPS飛行模式。



Simplified setup, APS LITE is functional with a few setup steps.
設定容易，只要經過幾個步驟就可以開啓APS LITE功能使用。

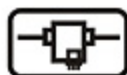

Supports Spektrum and JR satellite receivers.
支援SPEKTRUM與JR衛星天線。



Supports Futaba S.Bus architecture.
支援Futaba S.BUS功能。



Software upgradable through PC interface adapter.
具備可升級程式化介面，可透過傳輸線更新軟體。



Compatible with helicopter of all sizes from T-REX 250 to T-REX 800.
相容迷你型直昇機至大型直昇機T-REX 250~T-REX800。



Capable of operation between 3.5V to 8.4V, supports 2S Li-Po battery.
適用電壓3.5V~8.4V，支援2S鋰電池供電。



Small footprint, light weight, minimalists and reliable design.
體積小、重量輕，構造簡單可靠，提供操控者高性能的飛行樂趣。



RoHS certified.
符合RoHS限用規章。

APS LITE GYRO PARTS IDENTIFICATION AND INSTALLATION

APS LIET 陀螺儀各部位名稱及安裝說明

ALIGN

1 APS LITE GYRO SETUP INDICATORS

APS LITE 陀螺儀各部位名稱

1 APS LITE CONTROLLER

APS LITE 控制器

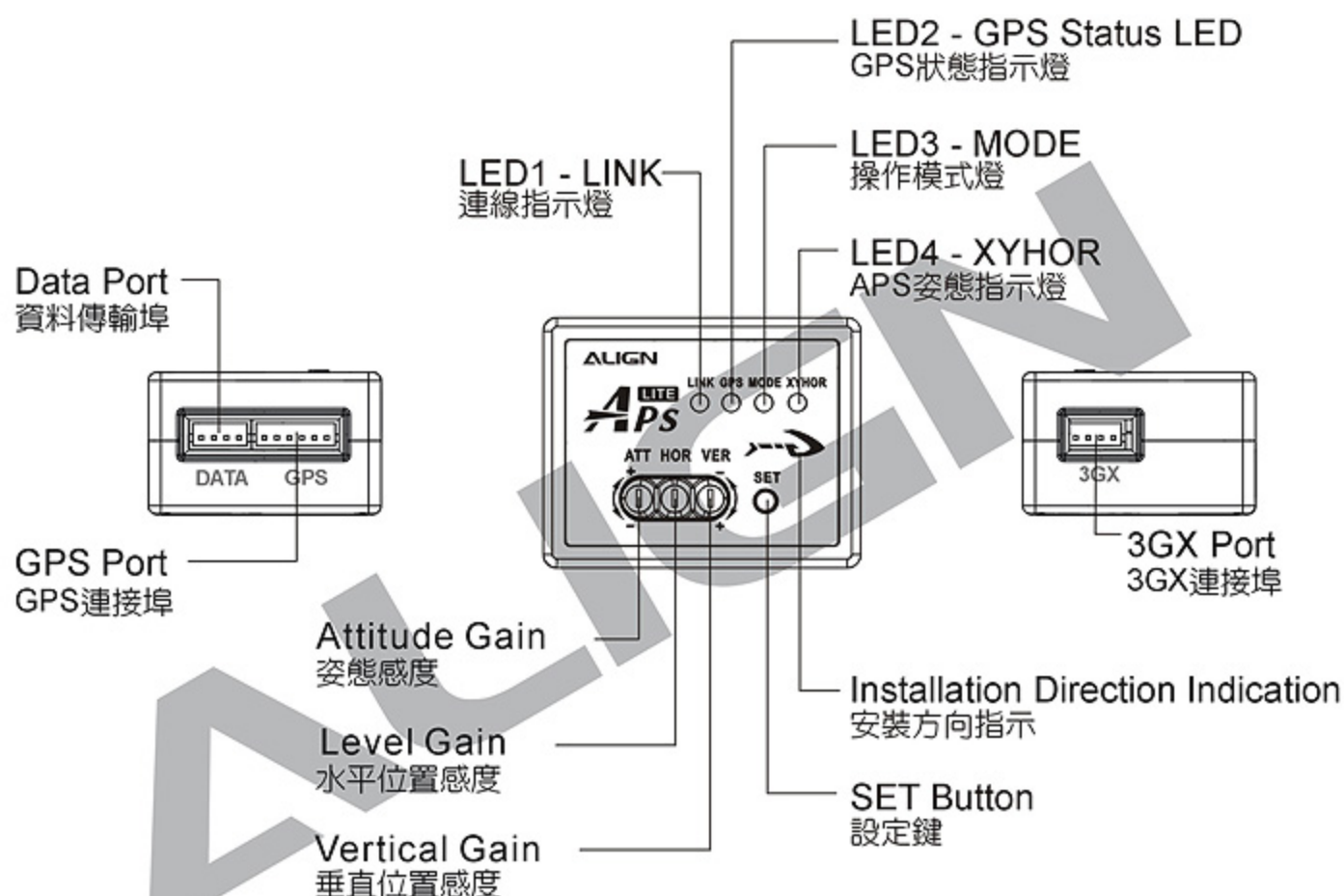

2 APS SENSOR

APS 感應器

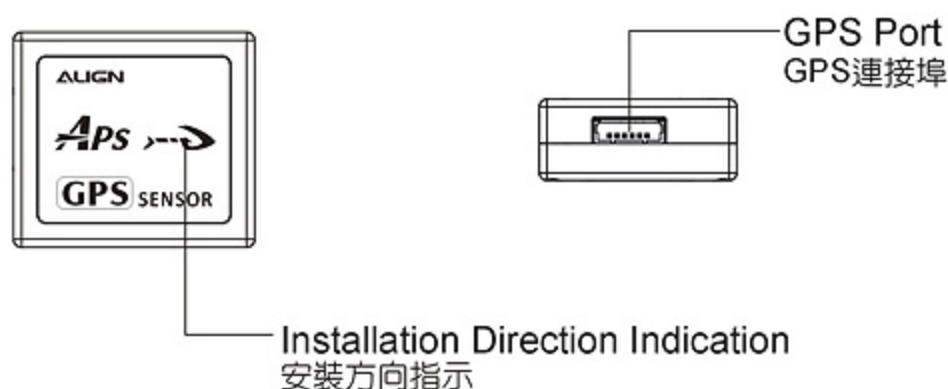

2 CONNECTION METHOD

接線方式

APS sensor
APS 感應器



APS LITE controller
APS LITE 控制器

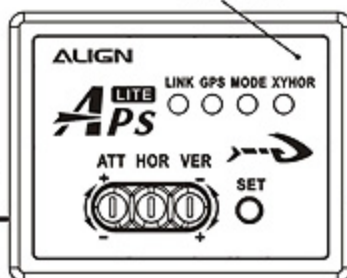

GPS port

GPS wire
GPS 訊號線

3GX port

APS wire
APS 訊號線

Remote receiver
衛星天線

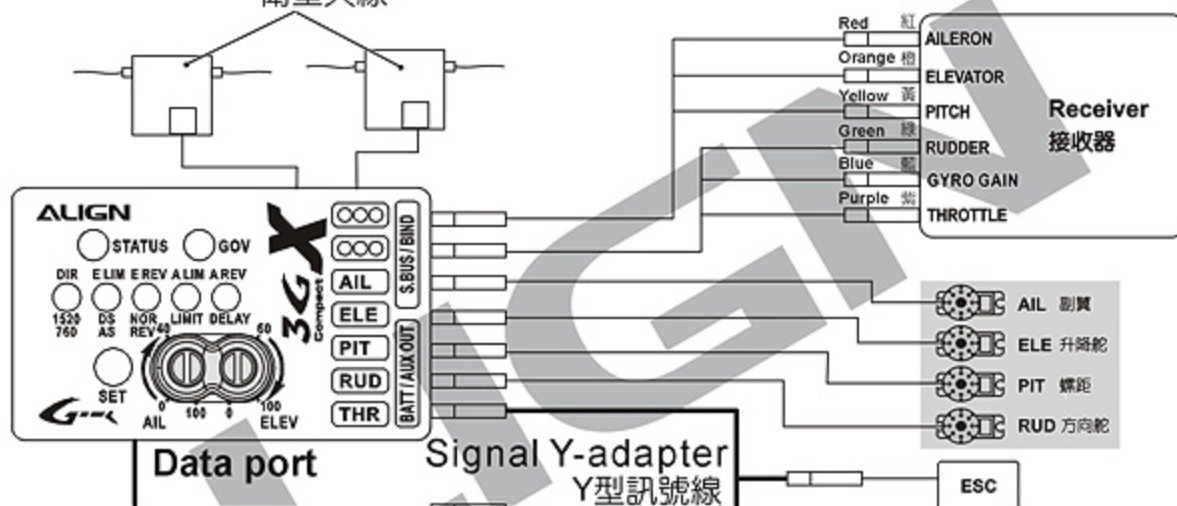

3 APS LITE CONTROLLER SETUP INDICATORS

APS LITE 控制器功能設定指示燈說明

LINK LED

連線指示燈



Green Light: 3GX connected
Red light: vibration test not passed
Red light flashing: Improper start up. Please restart. (Do not move the controller when APS LITE starting up.)

Light off: 3GX not connected

綠燈: 與3GX連線
紅燈: 未通過震動測試
紅燈閃爍: 開機異常, 請重新開機 (APS LITE 開機時不可晃動控制器)
熄滅: 未與3GX連線

GPS Status LED

GPS狀態指示燈



Green light: GPS signal acquired
Red light: Searching GPS signal

Light off: APS sensor not connected

綠燈: GPS定位完成
紅燈: GPS定位中
熄滅: 未連接APS感應器

MODE LED

操作模式燈

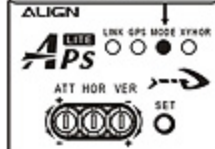

Green light: APS flight mode
Green light flashing: GPS flight mode
Light Off: 3GX flight mode

綠燈: APS飛行模式
綠燈閃爍: GPS飛行模式
熄滅: 3GX飛行模式

XYHOR LED

姿態指示燈



Green light: APS LITE controller is leveled

Light off: APS LITE controller is not leveled.

綠燈: APS LITE 控制器處於水平狀態
熄滅: APS LITE 控制器未處於水平狀態

1 APS LITE CONTROL UNIT INSTALLATION PRECAUTIONS

APS LITE 控制器安裝注意事項

- Installation should be at location with minimal vibration, and as near helicopter's rotational axis as possible. The installation and mounting instruction in the manual must be followed accurately. APS LITE's performance and vibration level is inversely proportional: the less the vibration, the better the performance. **Installation on tail boom mounting block is recommended. Do not install upside down.**
- APS LITE control arrow must point toward the front of helicopter, with the panel face up. Incorrect installation will result in unusable sensor data and cause the helicopter to lose control.
- APS LITE control must be mounted with the included double sided tape. Use of other double sided tape will affect APS LITE's performance and should be avoided; otherwise lost of helicopter control may occur.
- Due to the vibration from nitro engines, APS LITE needs to be installed with the dedicated metal plate to minimize the effect to APS LITE performance.
- Please perform vibration test after installation to ensure proper install location. Refer to Page 31.
- 請安裝在靠近直昇機震動程度較小的地方，請務必遵照說明書的指示安裝與固定，APS LITE 的性能和震動程度的大小成反比，震動越小，性能越好。**建議安裝於尾管固定座上，並且不可反裝。**
- APS LITE 控制器面板上的方向指示箭頭一定要朝向機頭方向，且面板標籤一定要朝上。若方向不對，會造成 APS LITE 有錯誤的資訊而造成直昇機失控。
- APS LITE 控制器固定時一定要使用隨附的專用泡棉，禁止使用其他市面上販售的泡棉，以免影響 APS LITE 性能表現，甚至造成直昇機失控。
- 因為引擎直昇機震動較電動直昇機大，使用時務必裝上專用鐵片，可以減低引擎震動對 APS LITE 的影響。
- 安裝完畢後務必執行震動測試，確認安裝位置與機況是否適合，請參考第31頁。

1 ELECTRIC HELICOPTER (LOW VIBRATION) INSTALLATION

電動直昇機（低震動）安裝方式

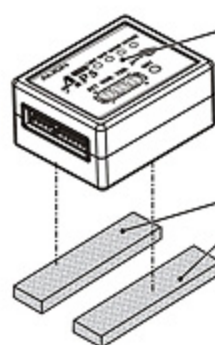

APS LITE controller
APS LITE 控制器

APS controller vibration dampening foam
APS 控制器防震泡棉

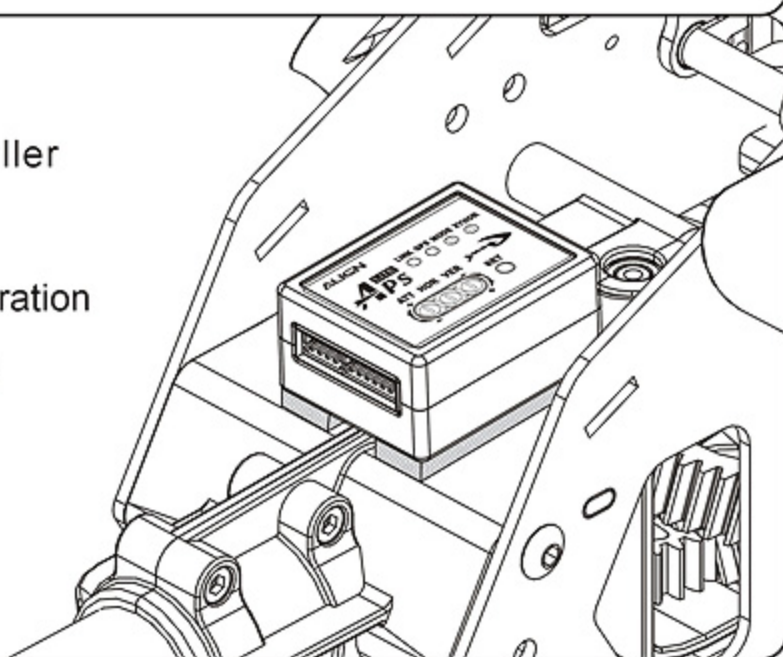

2 NITRO HELICOPTER (HIGHER VIBRATION) INSTALLATION

引擎直昇機（較高震動）安裝方式

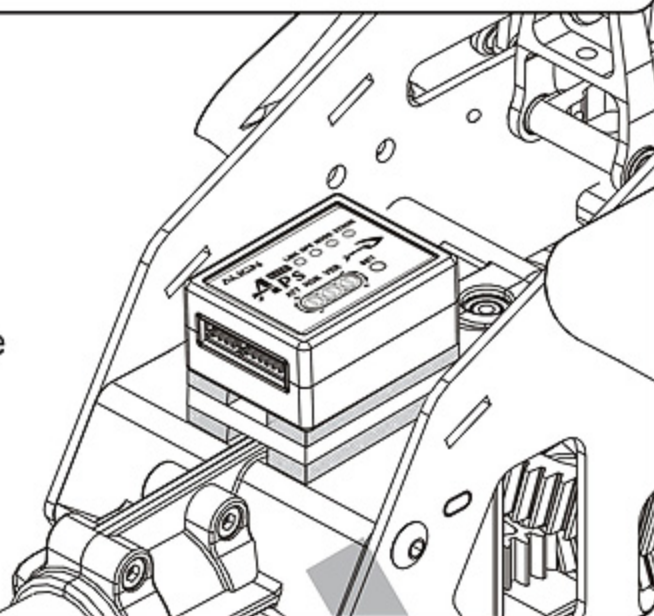
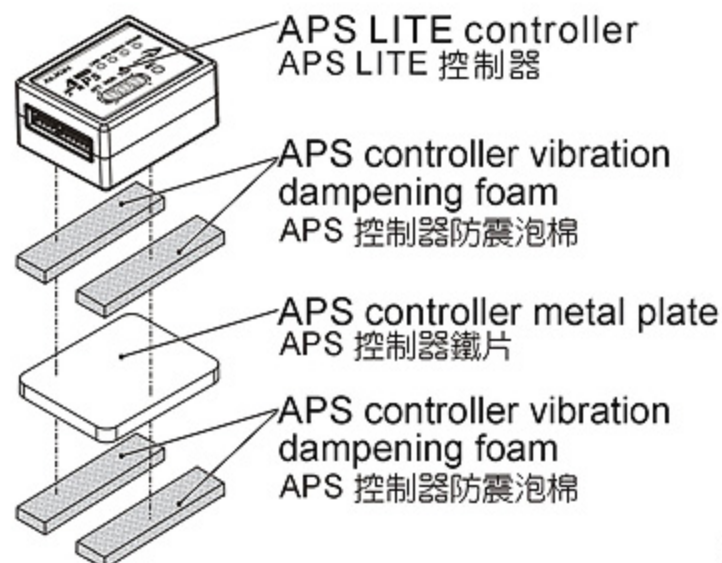

CAUTION
注意



Directional arrow must point toward the front of helicopter.
指示箭頭朝向機頭

FORBIDDEN
禁止

The panel cannot be face down.
面板標籤不可朝下



The panel cannot be face the side.
面板標籤不可朝向側面

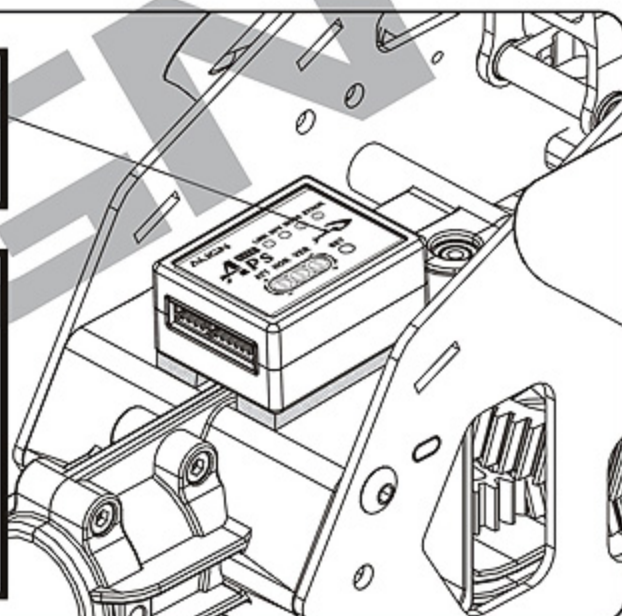

2 APS SENSOR INSTALLATION PRECAUTIONS

APS 感應器安裝注意事項

- APS sensor includes magnetometer, which is prone to interference from surrounding environment. Keep it away from servos, ESC, magnets, iron metals, batteries, wires, power wires, and other electrical components with strong magnetic field to avoid the effects to APS flight performance and unstable flight attitude.
- Wireless transmission signal may cause interference to the APS sensor, affecting the position hold performance. It should be kept away from wireless transmitter and its antennas (such as RF module antenna).
- The arrow on the APS sensor port must point to the front of helicopter. Reversed position will result in incorrect data passed to APS.
- APS 感應器包含3軸磁力計，磁力計很容易受到環境的干擾，安裝時請遠離伺服機、電子變速器、磁鐵、鐵質金屬、電池、電線等影響磁場零組件，避免磁力計讀取到錯誤地球磁場。
- APS 感應器也會受到無線通訊的訊號干擾，會造成定位控制性能不佳，安裝時請遠離無線通訊設備。
- APS 感應器面板上的方向指示箭頭一定要朝機頭方向，若方向不對，會造成APS有錯誤的資訊而不能使用。

APS SENSOR INSTALLATION METHOD

APS 感應器安裝方式

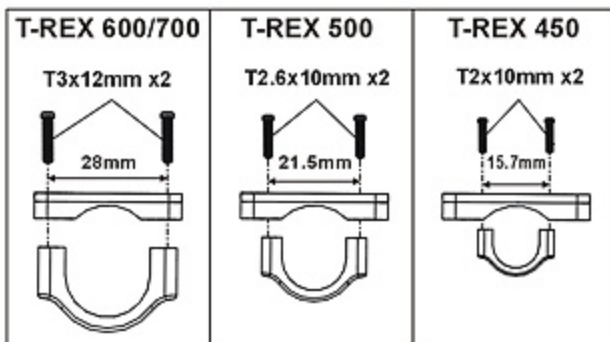

CAUTION
注意

To avoid interference to magnetometer, the included stainless steel screws must be used.

感應器座固定時必須使用專用不鏽鋼螺絲，避免磁力計受干擾

Stainless Screw
不鏽鋼圓頭十字自攻螺絲

APS sensor unit
APS 感應器座

APS sensor
APS 感應器

APS sensor double sided tape
APS 感應器雙面泡棉

FORBIDDEN
禁止

The panel cannot be face down.
面板標籤不可朝下

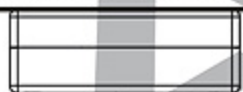

The panel cannot be face the side.
面板標籤不可朝向側面



CAUTION
注意



Directional arrow must point toward the front of helicopter.
指示箭頭朝向機頭

100mm Apporx.
約100mm以上

WARNING
警告

APS sensor install location should be away from servos, ESCs, metallic screws, wires, and other parts that might interfere with magnetic field. The recommended installation location is 100mm behind tail boom mount.

APS 感應器安裝時須遠離伺服器、電子變速器、鐵質螺絲、電線等干擾磁場的零組件，建議安裝於尾管固定座後方約100mm的位置。

3

APS LITE GYRO AND 3GX ILLUSTRATION

APS LITE 陀螺儀與3GX 配置圖示

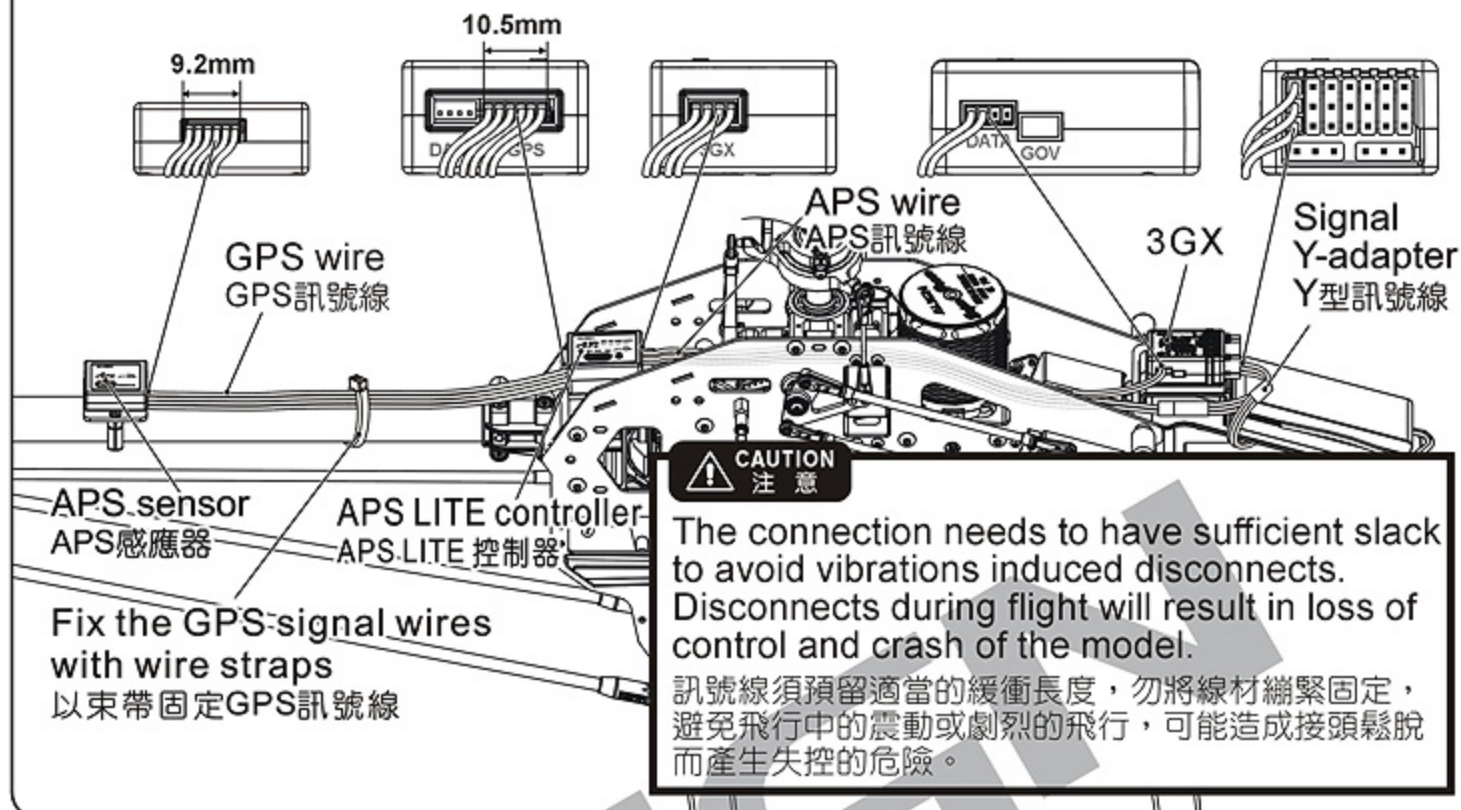

3GX SETTINGS

3GX設定

ALIGN

1

CONFIRM 3GX VERSION

確認3GX版本

3GX

Currently 3GX V3.1 and later are APS LITE compatible. The 3GX system must already be flashed with APS compatible firmware for proper connectivity and power on sequence with APS.

APS CD-ROM includes 3GX V3.1 (2013/04/03) software. Please follow the install instruction in the CD-ROM for update process.

使用APS LITE 陀螺儀之前，務必確認3GX韌體為V3.1以後版本，這樣才能與APS連接並正常開啟功能，3GX V3.1 (2013/04/03) 版包含以後版本內建APS驅動程式。APS光碟中內含3GX V3.1版程式，請依光碟中的安裝說明，完成V3.1版的更新。

STATUS green flash
STATUS綠燈閃爍

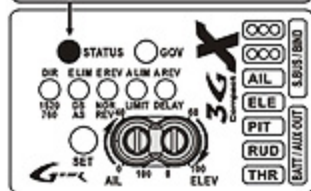

Flashing green LED: 3GX has correct firmware version and connection to APS is normal.

Steady lit green LED: Incorrect 3GX firmware version, unable to connect to APS.

綠燈閃爍: 3GX版本正確且與APS連線正常。

綠燈恆亮: 3GX版本錯誤，無法與APS連線。

CAUTION
注意

Please unplug the APS signal wire from 3GX during 3GX setting or update. Reconnect the wire after the update/setting has completed.

3GX版本更新及設定時，請先將APS訊號連接線從3GX上拔除，待3GX更新及設定完成後，再將3GX與APS訊號連接線接上。

1 METHOD 1: STANDARD RECEIVER CONNECTIVITY METHOD

方式一：傳統接收器接線法

- Connect all wires as shown in diagram. Receiver and 3GX wires are color coded to distinguish the different connection channels. Care should be taken to ensure proper wire color to channel connection.
- While using the speed controller that not including BEC, you need to connect the BEC power with 3GX "BATT" port.
- Receiver power is achieved by connecting the 3GX "S.BUS/BIND" port to the ch7 or BATT port on receiver using supplied signal wire.
- To avoid damage to servos, only digital servos should be used for swashplate.
- 3GX has built in speed governor function which can be utilized by purchasing the optional speed sensor. Governor setting is done through channel 7 on the receiver.
- 請依照圖示進行接線，接收器與3GX的接線使用不同的顏色來區分不同的通道，接線時請注意各顏色所對應的通道。
- 使用無BEC輸出的調速器時，須額外由3GX的"BATT"孔位接入BEC電源。
- 接收器電源請以隨附的訊號線由3GX的"S.BUS/BIND"孔位接至第七通道或BATT通道。
- 十字盤必須安裝數位伺服器，否則會造成伺服器損毀。
- 3GX內建定速器功能，可另購定速器感知器使用，轉速設定由接收器的第七通道設定。

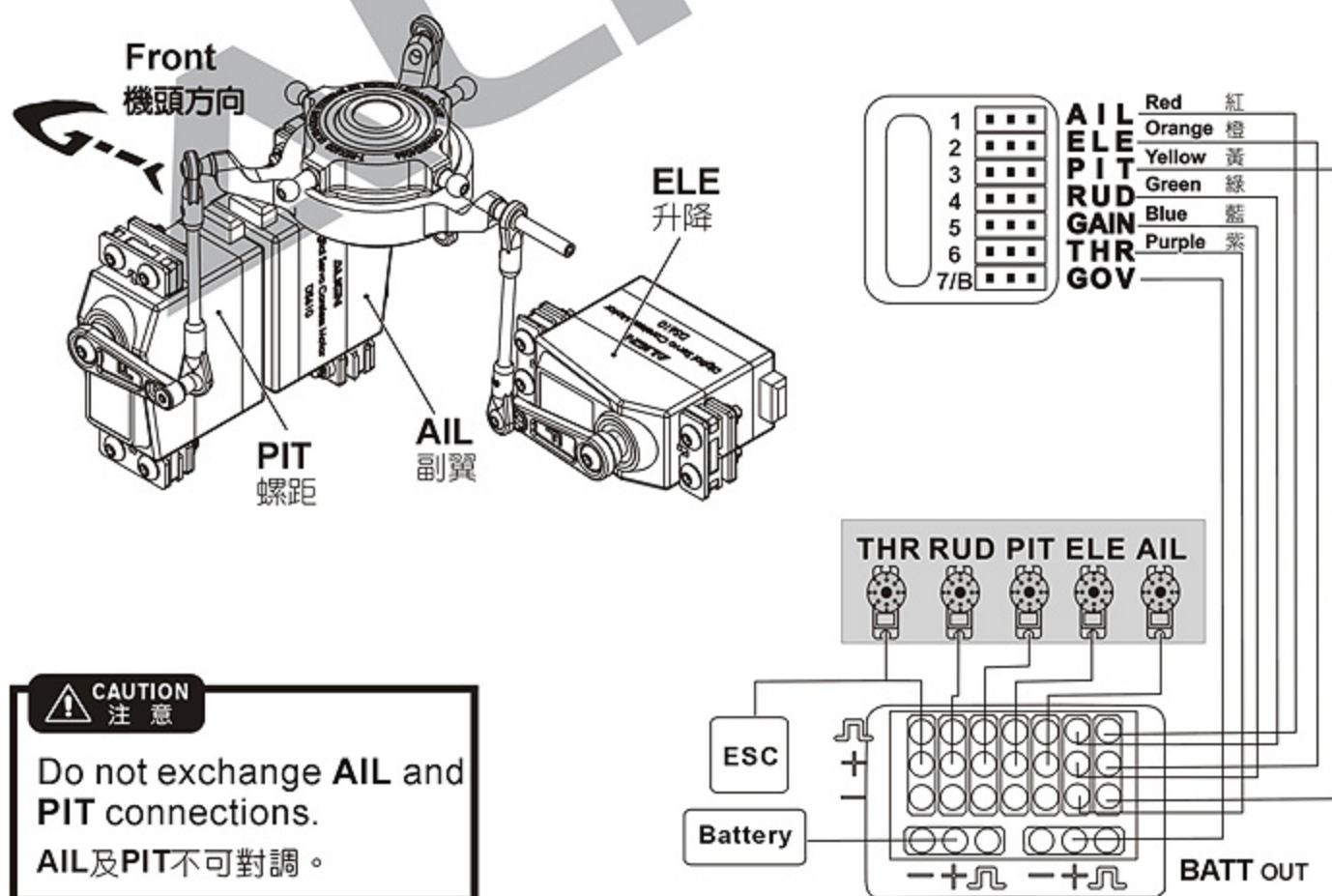

CAUTION 注意

Do not exchange AIL and PIT connections.
AIL及PIT不可對調。

2 METHOD 2: FUTABA S.BUS CONNECTIVITY METHOD

方式二：FUTABA S.BUS接線法

- For Futaba S.BUS receivers, connect wires as shown in diagram.
- While using the speed controller that not including BEC, you need to connect the BEC power with 3GX "BATT" port.
- Receiver power is supplied through S.BUS signal wire connected to 3GX's "S.BUS/BIND" port.
- The default channel/function mapping when using S.BUS are:
(1)AIL (2)ELE (3)THR (4)RUD (5)GAIN (6)PIT (7)GOV
- 具備S.BUS功能的Futaba接收器，請依照圖示進行接線。
- 使用無BEC輸出的調速器時，須額外由3GX的"BATT"孔位接入BEC電源。
- 接收器電源共同由S.BUS訊號線接至3GX的"S.BUS/BIND"孔位。
- 使用S.BUS功能時，內部通道已指定為：
(1)AIL (2)ELE (3)THR (4)RUD (5)GAIN (6)PIT (7)GOV



If channel 3 is set as PIT and channel 6 set as THR on transmitter, such as 8FG, 12Z, 14MZ, nd etc, please reprogram the transmitter to utilize channel 3 as THR and channel 6 as PIT.

若所使用的遙控器內部指定(3)通道為PIT (6)通道為THR時，例如8FG、12Z、14MZ等，請更改遙控器上的設定為(3)通道THR (6)通道PIT。

- To avoid damage to servos, only digital servos should be used for swashplate.
- 3GX has built in speed governor function which can be utilized by purchasing the optional speed sensor. Governor setting is done through channel 7 on the receiver.
- 十字盤必須安裝數位伺服器，否則會造成伺服器損毀。
- 3GX內建定速器功能，可另購定速器感知器使用，轉速設定由接收器的第七通道設定。

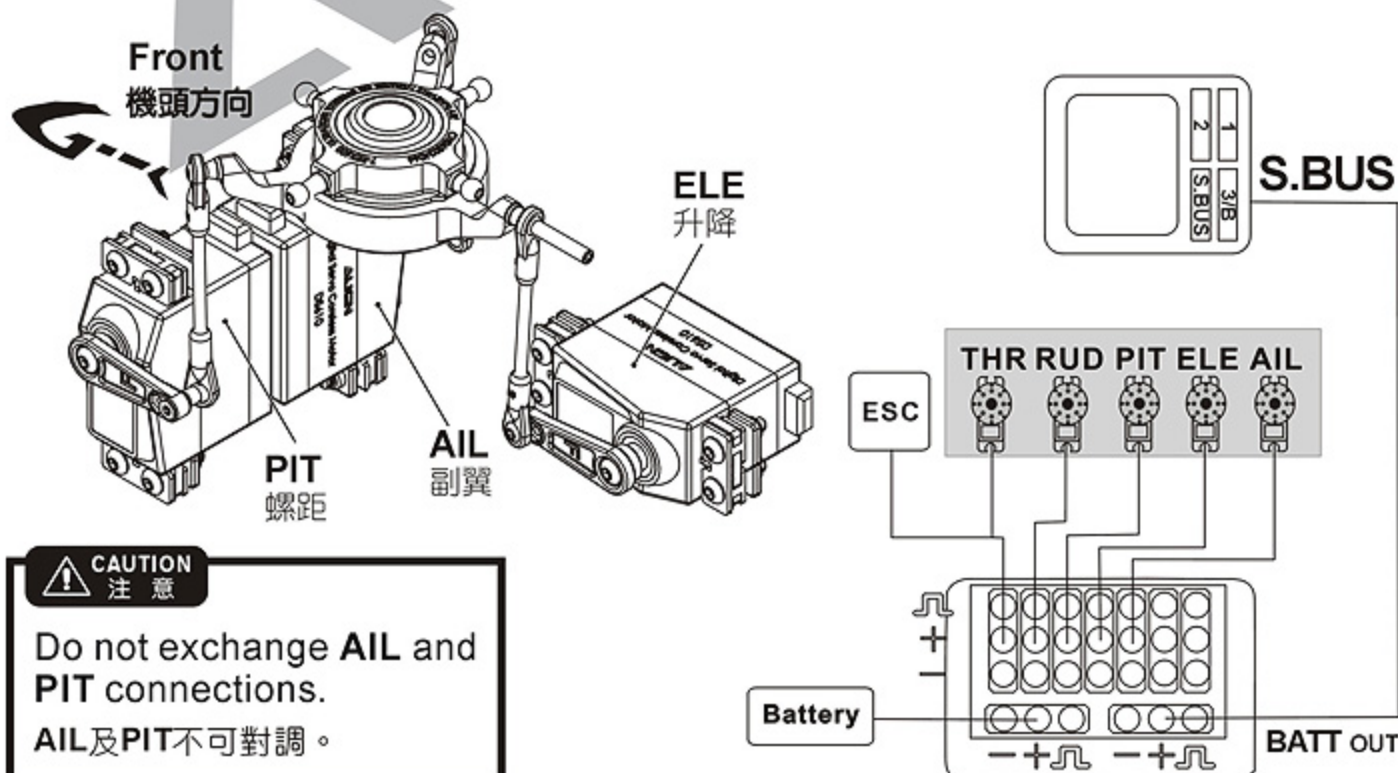

3 METHOD 3: JR/SPEKTRUM SATELLITE CONNECTIVITY METHOD

方式三：JR/SPEKTRUM衛星天線接線法

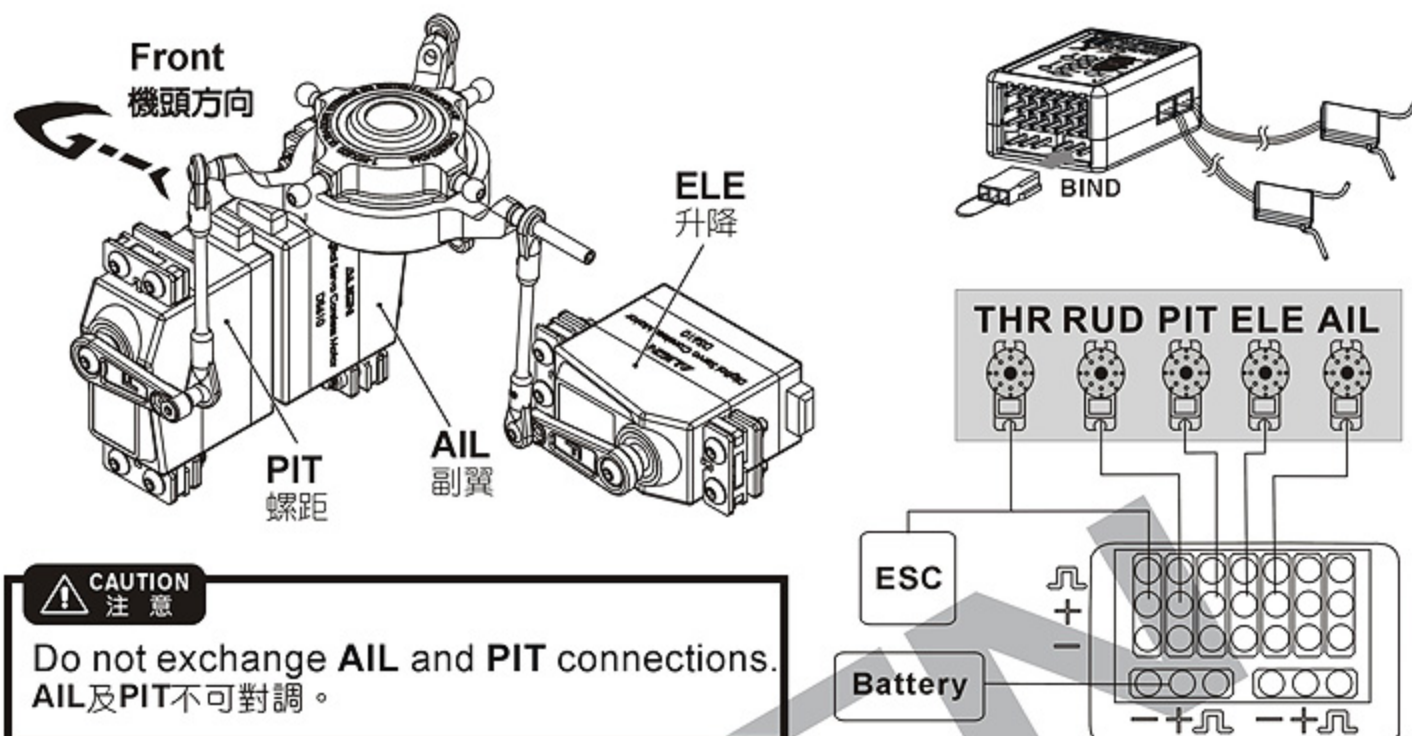

CAUTION
注意

Do not exchange AIL and PIT connections.
AIL及PIT不可對調。

- For JR or Spektrum satellite receivers, connect wires as shown in diagram.
- While using the speed controller that not including BEC, you need to connect the BEC power with 3GX "BATT" port.
- To avoid damage to servos, only digital servos should be used for swashplate.
- 3GX has built in speed governor function which can be utilized by purchasing the optional speed sensor. Governor setting is done through channel 7 on the receiver. Channel 5/GEAR controls RPM of speed governor, channel 7/AUX2 controls rudder gyro gain. For radios with less than 6 channels, please use the standard receiver connectivity method.
- For radios with less than 6 channels, channel 5/GEAR is used for rudder gyro gain. Speed governor cannot be used. For safety concern, two satellite receives should be used, with each antenna perpendicular (90 degrees) from each other. A satellite receiver should be installed on each side of the frame, separate by minimum distance of 5cm.
- Should both satellite receivers loose connectivity during flight, LED1 ~ LED5 will flash continuously as warning. A single power cycle of the system will not clear this error. The system need to be power cycled the second time to reset.
- Default channel/function mapping when using satellite receiver are:
(1)THR (2)AIL (3)ELE (4)RUD (5)GOV (6)PIT (7)GAIN
- 請依照圖示進行接線，3GX支援Spektrum與JR系統衛星天線。
- 使用無BEC輸出的調速器時，須額外由3GX的"BATT"孔位接入BEC電源。
- 十字盤必須安裝數位伺服器，否則會造成伺服器損毀。
- 3GX內建定速器功能，可另購定速器感知器使用。七動及七動以上遙控器(5)GEAR控制定速器轉速，(7)AUX2控制尾舵陀螺儀敏感度。六動以下遙控器請使用傳統接線方式。
- 為安全起見，請盡量安裝兩個衛星天線，兩個衛星天線角度除必須呈90度之外，且須安裝於機身兩側，相隔至少5公分以上。
- 如果飛行途中有兩個衛星天線同時失連的情形，LED1~LED5會持續閃爍警告，在此情形下就算重新開機，LED1~LED5會持續閃爍而無法開機，必須再重新開機一次，才可正常運作。
- 使用衛星天線接線時，內部通道已指定為：
(1)THR (2)AIL (3)ELE (4)RUD (5)GOV (6)PIT (7)GAIN



- Do not mix satellite receivers of different makes.
- Even under correct start up sequence, if transmitter is powered off first, LED1~LED5 will also flash. Thus the receiver should always be powered off before the transmitter.
- 3GX supports satellite receiver models currently available on the market. Should new receiver version comes out with compatibility issues, firmware will be updated to resolve any incompatibility that may arise.
- 不同廠牌的衛星天線請勿交叉對頻。
- 正常開機的情況下，如果先關發射機，也會發生LED1~LED5持續閃爍情況，所以請養成先關接收器，再關發射機的良好習慣。
- 如有新型號衛星天線產生不相容情形，將以韌體更新方式解決。

FAILSAFE (PRE-SET POSITION HOLD)

失控保護 (回復預設值)



When installing APS LITE system, radio failsafe should be set to fail to predefined position. First switch gyro from AVCS/heading hold mode to non-heading hold mode in normal flight condition, then set the non-heading hold gain to 0 for the failsafe setting procedure. After setting the failsafe, switch back to AVCS/heading hold, and restore the AVCS/heading hold gain value.

安裝APS LITE時，失控保護須採用"回復預設值"的方式，先將遙控器Normal 飛行的尾舵陀螺儀感度由原本的鎖定狀態(AVCS)改為非鎖定(NOR)，並將非鎖定數值百分比設為"0"，待失控保護設定完成後，須改回原3GX無平衡翼系統的尾舵鎖定感度值。

When helicopter lost connectivity with your radio under this setting, all channels will move to the pre-set position.

STEP

1. Plug the binding plug into 3GX's BIND port, and power up the 3GX. After the rapid flash of satellite's LEDs, pull the binding plug off.
2. Power up radio transmitter, and perform radio binding steps. After radio is bound, LED on the satellite antennas will end the rapid flash, following by slower flash.
3. Move the transmitter sticks to the desired failsafe position while the LED is flashing in slower mode.
4. Satellite antenna's LED will lit up after 5 seconds, and 3GX goes through initializing process. The failsafe position will be set after the 3GX initializes.
5. Test Method: Power off transmitter, and all channels should move to the pre-set failsafe position. (Please refer to Failsafe test on page 28)

在此模式下，若您的直昇機與遙控器失連，所有頻道為預設安全位置。

步驟

1. 將對頻接頭插在3GX的BIND插座，先開啓3GX電源，待衛星天線上LED快速閃爍後，將對頻接頭拔除。
2. 開啓遙控器電源，執行與遙控器的對頻動作，對頻完成瞬間，衛星天線上LED會由快速閃爍狀態熄滅，之後再亮起改為慢速閃爍。
3. 在慢速閃爍狀態時，將遙控器上的所有搖桿放置於您所需要的預設安全位置。
4. 5秒後衛星天線LED燈為恆亮，3GX進入開機狀態，待3GX開機完成後，即完成失控保護設定。
5. 測試方法：將遙控器關機，所有頻道為預設安全位置。（請參考28頁失控保護測試）

3

3GX SETTING PROCEDURE

3GX設定流程

3GX

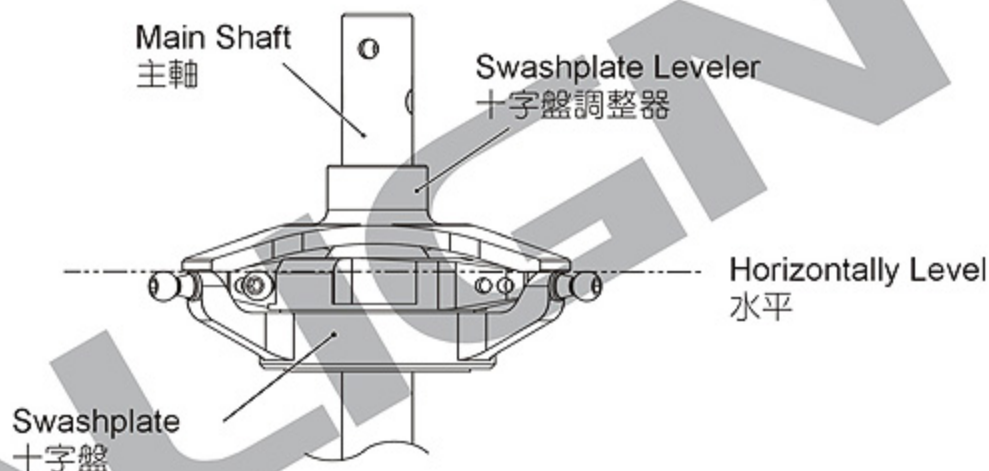

Before setting up the 3GX FBL system, please use a swashplate leveler to level out the swashplate. Adjust the length of servo linkage rod to make sure the swashplate is leveled before start setting up 3GX to ensure 3GX provides the best performance.

使用3GX無平衡系統，請務必使用十字盤調整器校正十字盤，調整伺服器連桿長度，確保十字盤達到水平狀態，再進行3GX基本機體設定，這樣才能確保3GX飛行性能達到最佳效果。

1 3GX BASIC SETTINGS

3GX 基本機體設定

Press and hold SET and powering up the receiver, release SET after LED lights up.
按SET+開啓接收器電源，燈號亮後放開SET鍵

STEP

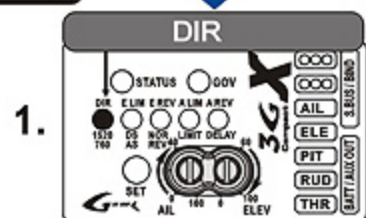

Press SET
按SET

● DIR Mechanical travel and neutral

Check direction, neutral, and max cyclic pitch is **8 degrees**.
※AIL and ELE within SWASH has the same value.

● DIR 機械行程與中立點

確認動作、中立點與 循環螺距8度
※SWASH的AIL與ELE數值相同

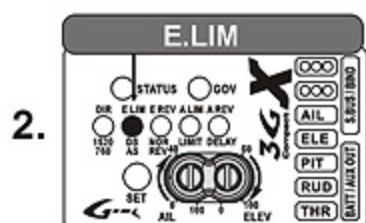

Press SET
按SET

● Mixing type detection and elevator travel limit setting

Push elevator all the way forward.
※Memorizes elevator travel limit.

● E.LIM 混控辨識及升降行程設定

推升降搖桿至最前
※記憶升降行程

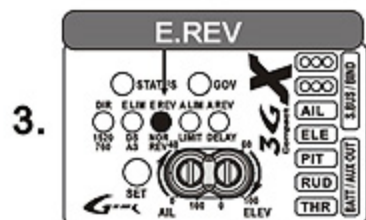

Press SET
按SET

● Elevator Reverse

Tilting heli forward/aft, swash should move the opposite direction to compensate.

※ If reversed, move elevator stick to reverse.

● E.REV 升降舵正反向

機體前後傾斜十字盤修正要反向
※如果錯誤，搖動升降桿更改修正方向

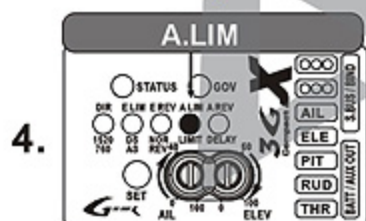

Press SET
按SET

● Aileron Travel Limit

Push elevator all the way to right.
※Memorizes aileron travel limit

● A.LIM 副翼行程辨識

推副翼搖桿至最右
※記憶副翼行程

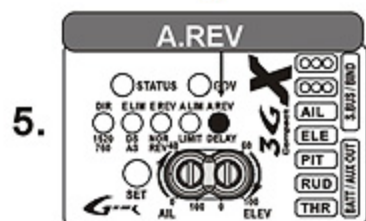

Press SET
按SET

● Aileron Reverse

Tilting heli left/right, swash should move the opposite direction to compensate.

※ If reversed, move aileron stick to reverse.

● A.REV 副翼正反向

機體左右傾斜十字盤修正要反向
※如果錯誤，搖動副翼搖桿更改修正方向

Setup Complete
完成設定

2 RUDDER GYRO SETUP 尾舵陀螺儀設定

While 3GX system is powered up, press and hold SET button for 1 second.
3GX系統開機狀態下，按SET鍵1秒

STEP



1.

Press SET
按SET

● 1520/760

STATUS LED: **Green** – 1520 Wideband **Red** – 760 Narrowband
※ Narrowband setting requires moving rudder 3 times.

● 寬頻/窄頻

STATUS LED: **綠** – 1520寬頻 **紅** – 760窄頻
※ 窄頻設定須撥打尾舵3次

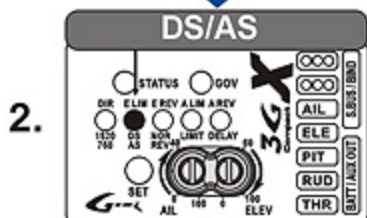

2.

Press SET
按SET

● DS/AS

STATUS LED: **Green** – Digital servo **Red** – Analog servo
※ Move rudder stick to change setting.

● 數位/類比伺服器

STATUS LED: **綠** – 數位伺服器 **紅** – 類比伺服器
※ 撥尾舵搖桿可更改設定

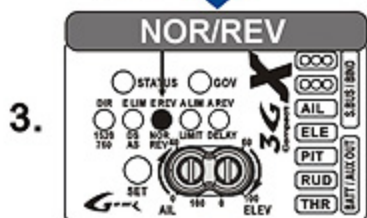

3.

Press SET
按SET

● RUDDER GYRO DIRECTION

STATUS LED: **Green** – Normal **Red** – Reverse
※ Move rudder stick to change setting.

● 尾舵陀螺正反向

STATUS LED: **綠** – 正向 **紅** – 反向
※ 撥尾舵搖桿可更改設定

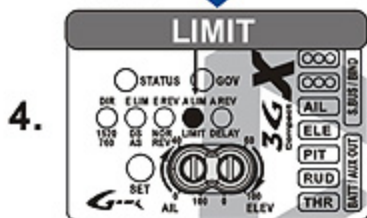

4.

Press SET
按SET

● RUDDER TRAVEL

Use rudder stick on transmitter to set travel limit.

● 尾舵行程

利用搖控器尾舵搖桿設定行程



5.

Press SET
按SET

● LARGE/SMALL HELICOPTER TYPE, AND RUDDER DELAY
STATUS LED: **Green** – REX 500/550/600/700 **Red** – T-REX 450/250
※ Move rudder stick to change setting.

● 大小直昇機及尾舵延遲

STATUS LED: **綠** – T-REX 500/550/600/700 **紅** – T-REX 450/250
※ 撥尾舵搖桿可更改設定

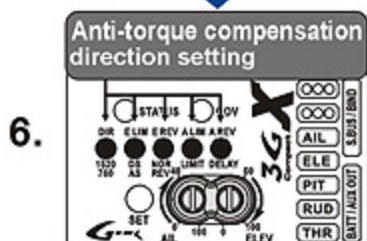

6.

Press SET
按SET

● ANTI-TORQUE COMPENSATION

STATUS LED: **Green** – Normal **Red** – Upside down
※ Move rudder stick to change setting.

● 反扭力補償

STATUS LED: **綠** – 正裝 **紅** – 反裝
※ 撥尾舵搖桿可更改設定

Setup Complete
完成設定

4

PRECAUTIONS FOR 3GX UPDATING TO V3.1

3GX更新V3.1以上版本注意事項

3GX

If your 3GX flybarless system is version prior to V2.0, there are some setting changes in V3.1. Please refer to the following 4 addendum to setup 3GX.

如果您目前的3GX無平衡翼系統是V2.0之前的版本，有幾項設定步驟在V3.1版裡會有變更，請您參考以下4項補充說明來設定3GX。

1 SERVO CHANNEL LAYOUT DIAGRAM

伺服器安裝位置圖

Servo channel layout diagram :

When connecting the helicopter's cyclic servos to 3GX, follow the channel mapping diagram below. Looking at the heli with nose pointing forward, right servo is aileron and connects to AIL channel on the 3GX; middle servo is elevator and connects to ELE channel; left servo is pitch and connects to PIT channel. Proper servo layout will ensure optimal self pirouetting effect.

伺服器頻道配置圖：

直昇機十字盤伺服器接上3GX時，必須遵從下圖的配置方式，當機頭朝前時，右側為副翼，請連接3GX的AIL頻道；中間為升降，請連接3GX的ELE頻道；左側為螺距，請連接3GX的PIT頻道。這樣配置主要是為了讓直昇機自旋時，有最佳的自旋效果不偏移。

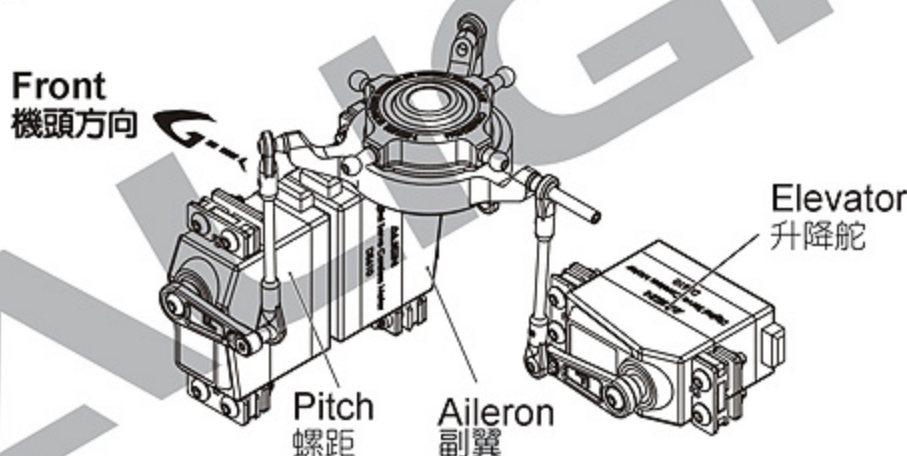

2 SETTING CYCLIC PITCH TO 8 DEGREES

設定循環螺距8度

Swashplate cyclic pitch setting: With the main blades parallel to helicopter body, throttle stick positioned where main pitch is 0 degrees, move aileron stick all the way to the right, adjust the AIL mixing ratio within radio's SWASH menu so the main blade pitch is the factory recommended value ± 8 degrees. The ELE mixing ratio in SWASH menu can be set to the same value as AIL.

If adjustments is needed for aileron and elevator roll rate, it can be done through 3GX interface's flight mode settings, or through 3GX PC interface.

十字盤循環螺距設定：將主旋翼方向與機體方向相同，油門搖桿置中，且於主旋翼角度0度的位置不動，撥動副翼搖桿至最右，調整遙控器Swash 中AIL比率，使主旋翼的攻角設定為原廠建議值 ± 8 度，搖控器Swash ELE比率請設定為與AIL比率相同即可。

若需調整副翼及升降滾轉速率時，可由3GX面板進入3GX飛行特性設定或透過3GX電腦介面調整。



注意

Adjustments to the CCPM servos endpoints should be done through transmitter's swashplate mixing function (AIL swash AFR). Do not adjust individual servos endpoints through the servo ATV/AFR function. Should any changes made to the endpoints or subtrims on the transmitter in the future, the flybarless system initial setup must be performed again.

CCPM系統調整行程量時，從遙控器Swash十字盤混控比率做調整，勿去調整個別伺服器的ATV行程量。爾後遙控器內微調如有變更，必須重新進行Flybarless各項設定。

±8° cyclic pitch
±8° 循環螺距

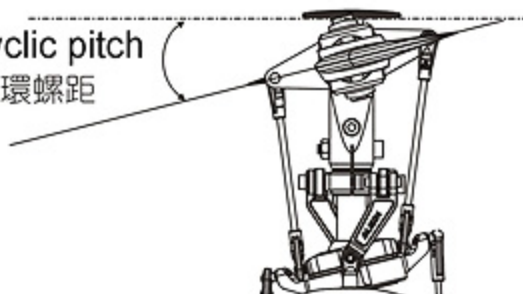

3 ANTI TORQUE COMPENSATION DIRECTION SETTING

反扭力補償正反向設定

To achieve consistent gyro gain on left and right, 3GX has built in anti-torque compensation function. User need to confirm if 3GX is mounted right side up or upside down.

為使陀螺儀左右感度一致，3GX內置反扭力補償功能，使用者需確認3GX為正裝或反裝。

Right side up: Installed with 3GX label facing up, anti-torque compensation set to positive (green STATUS LED).

正裝：安裝時3GX面板朝上，反扭力補償設為正向 (STATUS綠燈)。

3GX Right side up
3GX正裝



Upside down: Installed with 3GX label facing down, anti-torque compensation set to negative (red STATUS LED).

反裝：安裝時3GX面板朝下，反扭力補償設為反向 (STATUS紅燈)。

3GX Upside down
3GX反裝

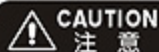
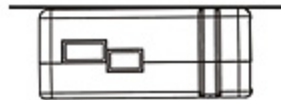

注意

If this setting is not set correctly, it may cause rudder control abnormalities during APS flight mode and GPS flight mode.

此設定若不正确時，將會造成進入APS 飛行模式及GPS 飛行模式時的尾舵控制方向異常。

Setup method: Press and hold the SET button for 2 seconds to enter setup mode, select until anti-torque compensation section, as indicated by lighting of all 5 setup mode LEDs. Using the rudder stick to select either positive anti-torque compensation (green STATUS LED) for right side up mounting, or negative anti-torque compensation (red STATUS LED) for upside down installation.

設定方式：持按"SET"鍵2秒進入功能設定模式，選擇至反扭力補償設定項，此時5顆功能設定指示燈全亮，接著以方向舵搖桿選擇，當3GX正裝時，須設定為正向 (STATUS綠燈)；當3GX反裝時，須設定為反向 (STATUS紅燈)。

Green : Right side up mounting

Red : Upside down mounting

綠燈 : 3GX正裝, 反扭力補償正向

紅燈 : 3GX反裝, 反扭力補償反向

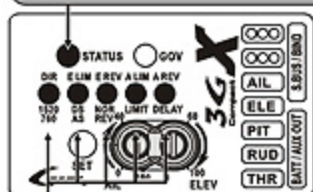

Anti Torque Compensation
direction setting

反扭力補償正反向設定

Select by moving the rudder
stick left and right

左右撥動方向舵選擇



RUD



4 3GX THROTTLE RANGE CALIBRATION

3GX 油門行程校正

After updating the 3GX firmware, follow the 3GX setup steps and complete the basic flybarless setup as well as gyro setup. Then the 3GX speed governor throttle calibration must be performed, this will enable APS LITE to have more precise throttle control during APS flight mode and GPS flight mode.

升級好3GX後,一樣依照3GX的設定方式,把基本的機體設定與尾舵陀螺儀設定完畢,接著一定要進行3GX定速器的油門行程校正,這主要是在啟動APS飛行模式與GPS飛行模式時,讓APS LITE能有正確且精準的控制。

STEP

1. Power on transmitter and reset throttle curve to default 0-50-100, press and hold 3GX SET button until LED on 3GX panel all light up, then release SET button.
2. Move the throttle stick from lowest to highest point to complete throttle calibration.
3. After throttle calibration is completed, 3GX will restart automatically.

步驟

1. 先將油門與螺距曲線回復到預設0/50/100設定,接著按下3GX SET鍵不放,並開啓直昇機接收器電源,讓3GX面板上LED依序亮起至全亮,接著再放開SET鍵。
2. 將油門搖桿從最低點推至最高點位置,設定完成後,3GX自動重新開機。
3. 開機完成後,關閉直昇機電源。



While setting throttle calibration, reset throttle curve and pitch curve to default 0/50/100.

遙控器油門行程校正時,先將油門/螺距曲線回復到預設 0 / 50 / 100設定。

Throttle/Pitch curve
油門/螺距曲線

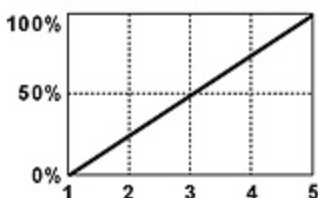

Press 3GX SET
button
按著3GX SET鍵不放

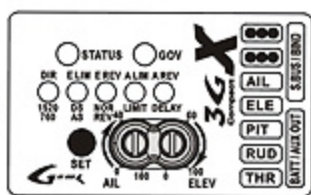

Turn on the
receiver power
開啓接收器電源

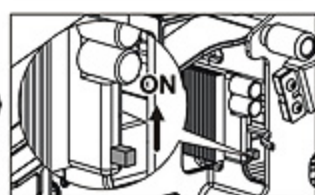

LED on 3GX panel all
light up
讓3GX面板上LED依序亮
起至全亮

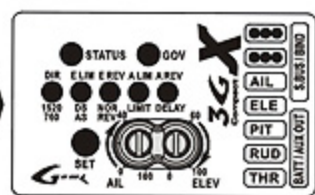

Release SET button
放開SET鍵

Move the throttle
stick from lowest
to highest point

將油門搖桿從最低點推
至最高點位置

After finish the setup,
red and green LED
start flashing and 3GX
restarts

設定完成後，紅綠燈閃
爍，3GX重新開機

Take off the receiver
power

關閉接收器電源

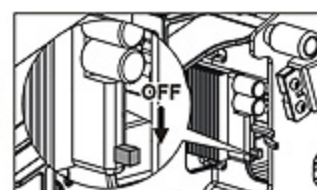
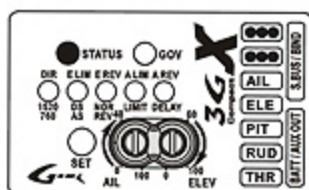
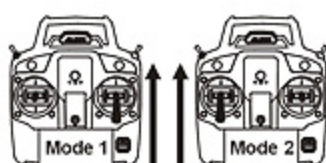
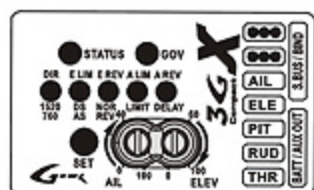

RC-TRANSMITTER SETUP

遙控器設定

ALIGN

1 TRANSMITTER SWITCH SETTING

遙控器開關設定

A switch must be assigned on the transmitter to control the APS LITE system. To simplify the APS LITE control, we recommend switch assignment as follow:

- Idle-up function should be on a dedicated switch.
- APS LITE control should be on a dedicated 3-position switch.

在使用之前，必須先指定遙控器開關的功能，為了讓您可以簡單與方便的來使用，遙控器上開關的分配方式，請依照下列說明來配置。

- 請將IDLE-UP特技模式指定使用獨立開關。
- APS LITE 開關使用獨立開關，且此開關必須具備有三段的切換。



CAUTION
注意

The switch location on radio varies between different models. 各型號遙控器指撥開關的所在位置並不相同

2 APS LITE CONTROL MODES SETTINGS

APS LITE 操作模式設定

- Align APS LITE Gyro has three flight modes. To simplify the mode switch process, APS LITE is designed to switch mode through the **rudder gain** settings on the transmitter. In another word, when you switch to the pre-defined gyro gain, the specific APS LITE mode will be activated. Below you will find the setup method.
- The transmitter settings still follows that of 3GX, except some minor changes to the rudder gain which divides the values and map to each of the APS flight modes.

3GX Flight Mode: For sports and 3D flying, gain is set to heading lock (Futaba AVCS 1%~100%, JR 51%~100%)

APS Flight Mode: Rudder gain is set to 0% for Futaba (JR 50%)

GPS Flight Mode: Rudder gain is set to non-heading lock rate mode, FUTABA NOR 30%(JR 35%).

- 亞拓APS LITE陀螺儀具備3種飛行模式，為了方便玩家切換使用各種飛行模式，APS LITE 特別設計藉由遙控器尾舵感度作為模式切換指令。簡單說就是設定指定尾舵感度，當開關切換到此感度時，APS LITE 就會開啓此指定感度的飛行模式，以下就是飛行模式的感度設定說明。
 - 遙控器可以沿用3GX的設定，只需在尾舵感度方面做些調整，分配感度區域給APS飛行模式使用。
- 3GX 飛行模式：**即一般飛行與3D飛行使用，感度為鎖定FUTABA AVCS 1%~100% (JR 51%~100%)。
- APS 飛行模式：**尾舵感度設定為 FUTABA 0% (JR 50%)。
- GPS 飛行模式：**尾舵感度設定為非鎖定FUTABA 設為NOR 30%(JR設為35%)。

Using Futaba T8J as an example
以 Futaba T8J 為例

GYRO SENS	
MIX ▶ ON	
CH ▶ RUD	UP ▶ AVC 37%
(CHS)	DWN ▶ 0%
TYP ▶ GY	DWN ▶ NOR 30%
SW ▶ SwC	(DWN)

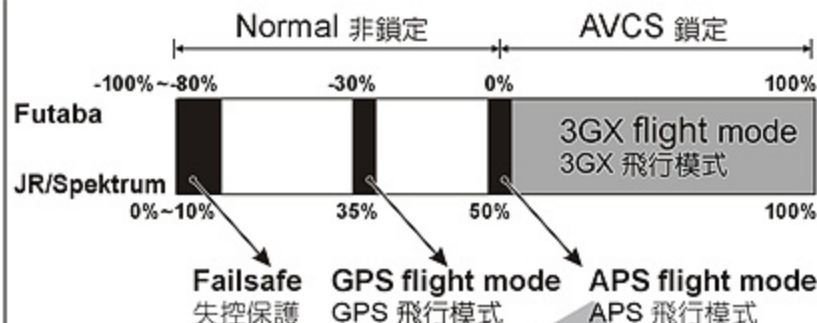

3 APS LITE SWITCH CONFIGURATION

APS LITE開關配置

- First APS LITE switch position is 3GX flight mode. This is the standard 3GX flight mode where all control characteristics are identical to as if APS wasn't installed. Gain adjustments are also identical to those in 3GX.
- Second APS LITE switch position is APS flight mode. In APS flight mode, helicopter can perform semi-autonomous takeoff/landing, position and altitude hold hovering, as well as emergency bailout function (please refer to APS flight mode on page 39).
- Third APS LITE switch position is GPS flight mode. In GPS flight mode, helicopter can perform return home function (please refer to GPS flight mode on page 44).

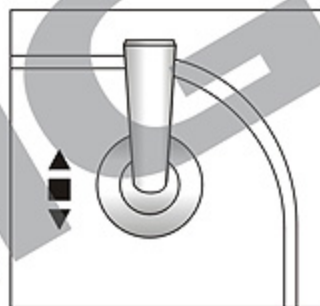

- 3GX Flight Mode
3GX飛行模式
- APS Flight Mode
APS飛行模式
- GPS Flight Mode
GPS飛行模式

CAUTION 注意

Warning: Prior to use, the rudder gain for 3GX flight mode must be set to a value within range of the AVCS heading hold mode; do not set to a non-heading hold NOR mode value. The two rudder gain value for APS flight mode and GPS flight mode are used strictly for mode switching; APS will automatically use the rudder gain value from 3GX flight mode. Therefore do not be alarmed if the rudder gain for APS flight mode and GPS flight mode is set to 0 or a non-heading hold value.

使用時務必要設定 3GX飛行模式的感度，且感度值要設定在鎖定AVCS範圍內，不能設為非鎖定NOR。而APS 飛行模式與GPS飛行模式兩模式的尾舵感度只是讓ASP LITE 判斷進入模式的指令，APS LITE 會自動以遙控器中第一段鎖定AVCS的尾舵感度當作APS 飛行模式與GPS飛行模式飛行的尾舵感度，不必擔心APS 飛行模式與GPS飛行模式的感度為0或者非鎖定時，直昇機會有鎖不住情況發生。

- 第一段APS LITE 開關定為3GX飛行模式，即一般3GX飛行模式，所有的操作特性都和3GX一致，感度值的調整也和3GX一樣。
- 第二段設為APS 飛行模式，在APS飛行模式下，可執行半自動起飛/降落、直昇機定位高度停懸以及緊急姿態平衡等功能(參考第39頁APS飛行模式)。
- 第三段設為GPS飛行模式，在GPS飛行模式下，可執行自動返航功能(參考第44頁GPS飛行模式)。

4

STATUS LIGHT INSTRUCTION

狀態指示燈說明

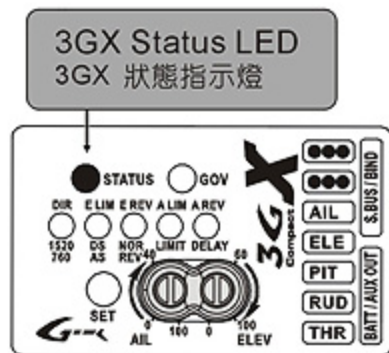

APS LITE Control Mode LED APS LITE 操作模式燈

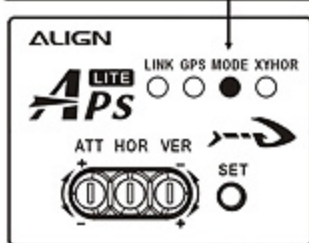

3GX Flight Mode 3GX 飛行模式	Flashes Green 閃綠燈	3GX Flight Mode 3GX 飛行模式	Off 熄滅
APS Flight Mode APS 飛行模式	Flashes Orange 閃橘燈	APS Flight Mode APS 飛行模式	Constant Green 綠燈恆亮
GPS Flight Mode GPS 飛行模式	Flashes Red 閃紅燈	GPS Flight Mode GPS 飛行模式	Flashes Green 綠燈閃爍

After setup, use 3GX and APS LITE LED to check for correct settings. Should there be mismatch of LED signal, please go back and recheck the settings.

設定完成後，可以利用3GX和APS LITE的LED檢查設定是否正確。若燈號有任何一項不符合，請重新檢查設定是否正確。

5

THROTTLE/ PITCH CURVE SETTING

油門螺距曲線設定

While in APS flight mode and GPS flight mode, throttle curve on the transmitter must be in straight line, or utilize external speed governor function of engine or ESC to lock the rotor head speed. The throttle curve for 2nd and 3rd position of the switch (The setting of throttle curve for APS flight mode and GPS flight mode are shown in the top of page 28). The actual curve value can be adjusted to achieve suitable headspeed of your helicopter. We recommend using a speed that is 100-200RPM higher than your normal hovering headspeed.

To ensure optimal APS LITE performance which may vary between different helicopters, APS LITE has a build in vibration self-test feature which will activate the system only when helicopter vibration is below a threshold value. Therefore, after vibration test has already passed, any changes to throttle curve should be avoided; but if it must be done, it must be followed by a vibration self-test again before the system can activate. Vibration self-test will be described later (see page 31).

APS LITE allows the pilot to adjust the minimum pitch in the pitch curve based on flight preference, allowing the APS LITE system to provide control feel more familiar to the pilot. One such example: many pilots prefer setting the minimum pitch to -3 degrees in normal mode. But be aware that the pitch must still be set to 0 degrees at mid stick, 50% rate position; and the pitch curve for Normal and Idle-Up modes must be identical.

This will allow APS LITE to precisely make altitude correction, and execute pilots commands. Incorrect pitch curve settings will result in unstable and non-precise control of the helicopter.

在使用APS飛行模式與GPS飛行模式時，遙控器油門曲線必須設定為水平的一直線，或者使用引擎定速器、電子變速器定速功能來固定主旋翼轉速。APS飛行模式和GPS飛行模式的油門曲線設定如第28頁上方圖示，油門曲線大小調成適合自己直昇機的轉速，建議設定高於Normal停懸轉速100~200轉。

因為每台直昇機狀況不同，為了確保APS LITE有最佳性能，APS LITE納入了判別機制－震動測試，也就是直昇機震動必須小於標準才能開啓APS使用。所以油門曲線設定的轉速，必須通過震動測試才能開啓APS LITE使用，且不能隨意更改通過震動測試的油門轉速設定，如要更動轉速必須再次通過震動測試才能使用，震動測試在後面會有詳細介紹（見第31頁）。

APS LITE可以依使用習慣調整螺距曲線最低的螺距角度，讓APS LITE飛行更貼近自己習慣的操控手感，例如：常見一般飛行模式會把最低螺距設為-3度。但要特別注意，油門搖桿在中間點位置的螺距必須為0度，設定值為50%，並且Normal與IDLE-UP模式的螺距曲線要相同。

如果在APS飛行模式與GPS飛行模式下，使用不正確的螺距曲線，直昇機會呈現高度不穩定與高度控制不準確的情況發生。



Normal mode with standard throttle curve must be used when performing APS semi-autonomous takeoff/landings. Normal throttle curve examples are shown in the top of page 28, can be set similar to curve 1 or curve 2. Choosing curve 2 enables smoother throttle compensation during hover, and is able to maintain hover altitude easier.

使用APS飛行模式半自動起飛／降落時，必須使用Normal一般模式的油門曲線來起飛／降落，Normal油門曲線如第28頁上方圖示，可選擇曲線①或曲線②的方式設置，選擇曲線②的設置可使直昇機於停懸時，主旋翼轉速的變化量較為平順，容易維持直昇機停懸高度。

- To ensure proper operation of APS LITE correction routine, pitch must be zero degrees at throttle mid stick, with value at 50%.
- **After entering APS flight mode, throttle stick position controls the helicopter height and vertical movement speed; helicopter pitch is controlled by APS's response.**
- 為確保APS LITE修正的正常運作，油門搖桿在中間點位置的螺距要為0度，且設定值要為50%。
- 當進入APS飛行模式後，油門搖桿的位置是控制直昇機的高度與垂直移動的速度，直昇機的螺距角度是由APS控制反應。

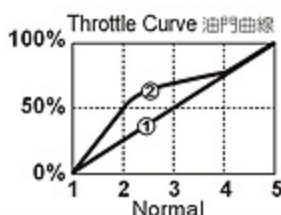
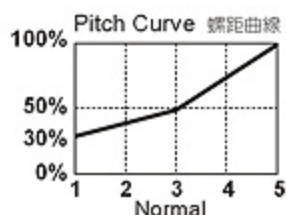
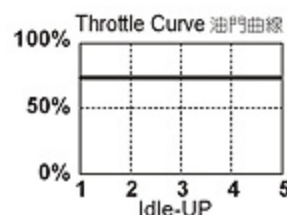
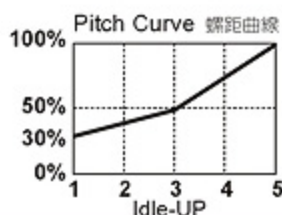
SEMI-AUTONOMOUS TAKEOFF/ LANDING 半自動起飛/降落**APS FLIGHT MODE/ GPS FLIGHT MODE APS飛行模式/GPS飛行模式**

6 FAILSAFE PROTECTION SETTINGS

失控保護設定

Take Futaba T8J radio as an example, set the failsafe to rudder gain at NOR 100% (JR 0%). When helicopter loses RC signal while in APS or GPS flight modes, APS LITE will take over and fly the helicopter back home automatically, at this point set the APS LITE switch to GPS flight mode. To cancel out of the automatic return home mode before or after arriving at HOME position, switch to APS mode to hold helicopter in position or 3GX mode to regain manual control. (To register home point, please refer to "RETURN HOME"

以Futaba T8J遙控器為例，將失控保護設為尾舵非鎖定NOR 100%(JR 0%)。當直昇機於APS或GPS飛行模式下失去遙控器訊號，無法控制時，APS LITE 陀螺會開啓失控保護功能，使直昇機自動返航至Home點，直昇機自動進入返航指令時，須先將APS LITE 開關置於GPS飛行模式的位置，若抵達Home點或返航途中，要解除自動返航指令時，可切入APS模式使直昇機定位停懸或切入3GX模式手動飛行。(Home點設置請參考45頁，自動返航Home點)

檢測設定是否正確，在開機完成的情形下將遙控器關閉，若設定正確，APS LITE 上的LED1~LED4會閃爍綠燈。測試完成後，請關閉接收器電源，重新開機。

CAUTION 注意

- If failsafe isn't setup or home location is not registered, helicopter will not be able to perform automatic return home function during signal loss.
使用者若未設置失控保護功能與返航Home點時，將無法使用直昇機於訊號失控時自動返航。
- Base on safety issue, Failsafe is not functional under 3GX flight mode.
基於安全因素，在3GX飛行模式下不支援失控保護功能。

WARNING 警告

This control is used solely for failsafe testing purposes. To prevent unforeseen danger, do not turn off transmitter mid-flight. Even though the helicopter will enter failsafe return home mode after transmitter is switched off in mid-flight, certain transmitters are designed to power up only when the Idle-Up and throttle are switched off. Therefore, powering up the transmitter may cause helicopter to shut-off its power, resulting in free falling danger.

此操作僅供失控保護設定測試用，嚴禁在飛行中將遙控器關機，以免造成直昇機失控與發生不可預期的危險：在飛行中將遙控器關機時，雖然直昇機進入自動返航功能，但部份遙控器的安全設計，必須在油門與Idle Up開關關閉的位置才允許開機，因此重開機時，會造成直昇機動力關閉，且直昇機急速墜落的危險。

Gyro gain channel set to non-heading lock gain
陀螺儀頻道設為非鎖定感度

FAIL SAFE (2/2) SFHSS

	MODE	POSI	
5: GYR	FS	---	100%
6: PIT	NOR	---	---
7: AU1	NOR	---	---
8: AU2	NOR	---	---

- For failsafe settings on satellite receivers, please refer to page 17 of manual.
- 衛星天線的失控保護設定，請參照說明書第17頁。

Failsafe test
失控保護測試

Turn off the power
關閉電源

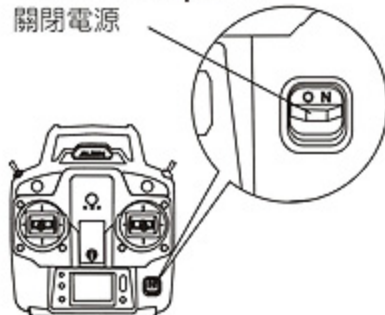

LED1~LED4
will flash
green when
setting is
successful
設定成功，
LED1~LED4會閃
爍綠燈

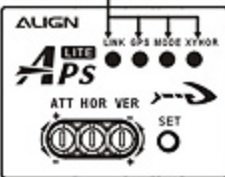

CALIBRATION BEFORE FLIGHT

飛行前校正

ALIGN

1

MAGNETOMETER CALIBRATION

磁力計校正

Objects on helicopter can interfere with magnetometer's readings, lowering APS LITE's heading precision, and even affect position hold ability. To reduce the environmental effect on magnetometer, APS LITE must be calibrated prior to use to ensure correct and stable operations.

Calibration must be done under these situations:

- The initial install of APS LITE modules.
- Changes to the GPS module.
- Additions or removal to electronic equipment near the magnetometer (Servos, ESC, etc).
- When flying at a different field, perform the calibration steps again.

磁力計在APS LITE 裡面是扮演辨別頭向與直昇機姿態的角色，而直昇機上的電子變速器、馬達、伺服機、螺絲、電線、鐵性物質等會干擾磁力計，影響APS LITE 頭向控制的準確度，甚至影響定位控制的效果。為了減少環境對磁力計的影響，所以使用APS LITE 前務必要執行磁力計校正的工作，才能讓APS LITE 有正確與穩定運作。在以下情況，必須做磁力計的校正：

- 第一次安裝APS LITE 時。
- 更換或移動GPS感應器時。
- 增加或減少磁力計附近的電子裝置（伺服器、電子變速器等）時。
- 當直昇機更換飛行場地時，請重新校正一次。



CAUTION
注意

Warning: Please perform calibration in open space, at least 10meters away from strong magnetic field and conductive materials (magnets, metal table, metal buildings, concrete floors, high voltage electrical tower etc).

External environment factors may affect the accuracy of magnetometer. Should helicopter experience poor position holding performance while in APS flight mode, please perform magnetometer calibration steps again.

請在空曠且遠離強磁和導磁物質10公尺以上（磁鐵、鐵桌、鐵皮屋、水泥地板、高壓電塔等）的地方校正。

外在環境的改變會影響磁力計的準確度，當直昇機於APS飛行模式下，發生定位效果不佳時，請重新校正磁力計。

STEP 步驟

1. Power up receiver, press and hold SET button 3 seconds to enter calibration mode. LED1 on APS LITE panel will light up solid red.

開啓接收器電源，長按SET鍵三秒就會進入校正程序，此時APS LIET 面板上LED1會亮紅燈。

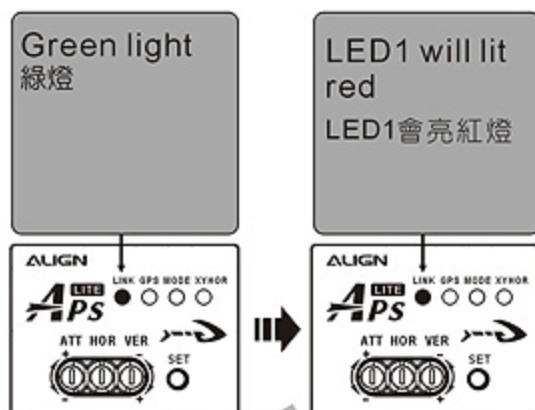

2. Pick up the helicopter and with the APS sensor as center of spin axis, spin the helicopter horizontally about 360 degrees until LED2 lights red.

拿起直昇機且以APS感應器為軸心，水平的旋轉直昇機約360度直到LED2也亮紅燈。

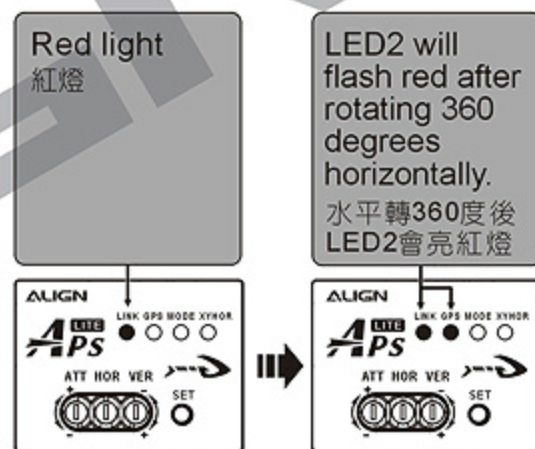
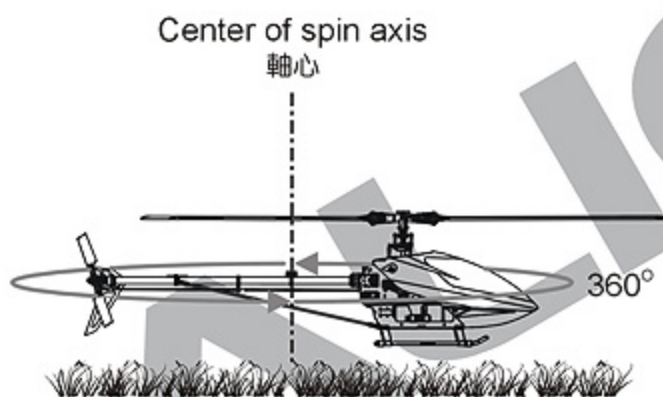

3. Point the helicopter nose to the top. Using APS sensor as center and spin the helicopter 360 degrees on its roll axis until LED1 and LED2 turns green.

將直昇機的頭朝上立起。以APS感應器為軸心再水平的旋轉直昇機360度直到LED1和LED2變成綠燈。

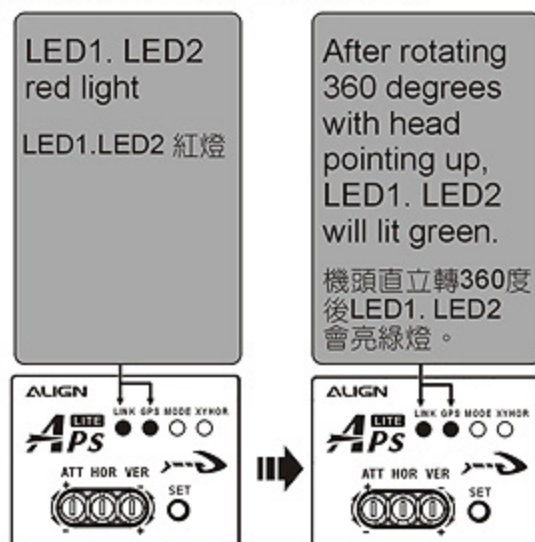
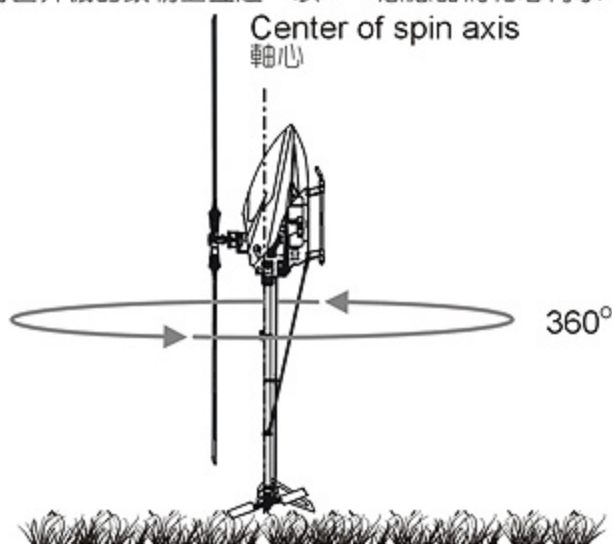

4. Calibration completed. Restart the system.
校正完成，請重新開機。

Turn off the receiver power
關閉接收器電源

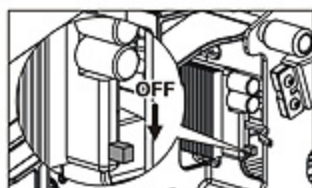

Turn on the receiver power
開啓接收器電源

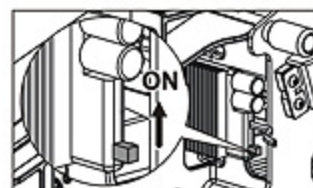

2 VIBRATION TEST 震動測試

Due to variations amongst different helicopters, and to ensure optimal performance of APS LITE gyro, a system validation's vibration test must be passed before APS LITE can be switched on for use.

If vibration test wasn't passed and APS function is switched on, possible loss of control and crash may occur.

If vibration test can not be passed after repeated attempts, please locate and eliminate the vibration source within the helicopter body, or follow the installation instruction on page 11 and add the metal plate to increase vibration dampening effect.

因為每台直昇機狀況不同，為了確保APS LITE 陀螺儀有最佳性能，納入了判別機制“震動測試”，也就是直昇機震動必須符合標準才能開啓APS LITE 使用。

如未執行通過震動測試，冒然開APS LITE 功能，會造成直昇機失控墜毀的危險。

假使震動測試屢試不過，請檢查、排除直昇機機體的異常震動源，或可參考第11頁的安裝說明增加鐵片提升避震效果。

CAUTION 注意

- Vibration test must be re-performed should helicopter experienced a crash, parts replacement or RPM changes. We recommend performing vibration test periodically every 10 flights to ensure safety.
- After passed vibration test and enter APS/GPS flight mode, do not change the rotor RPM, pitch and 3GX setting. Changing the setting can make the vibration conditions change, severe cases lead to a flight out of control of the crashes.
- 只要直昇機有變更主旋翼轉速設定、摔落或更換任何零件時，必須重新執行震動測試；此外建議每10趟飛行定期執行震動測試檢查，以確保安全。
- 通過震動測試後，進入APS/GPS飛行模式，嚴禁隨意變更主旋翼轉速、螺距及3GX設定而使震動條件改變，嚴重者將導致飛行失控摔機。

STEP 步驟

1. After power on the transmitter and helicopter, push the button once to enter Vibration Test mode. LED1 and LED2 will flash green.

將遙控器與直昇機開啓後，按一下SET鍵就可進入震動測試模式。此時APS上的LED1和LED2會開始閃爍綠燈。

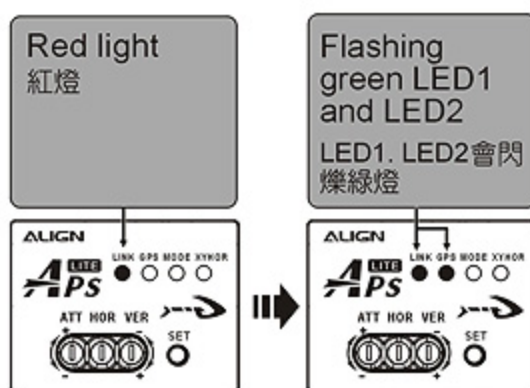
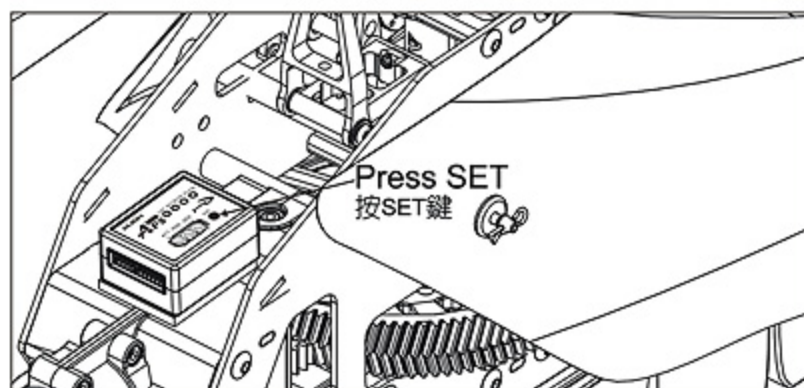

2. While in 3GX mode, slowly fly into a stable hover and hold for 30 seconds, then slowly land and shutoff engine. Vibration test must be performed with the same Idel-up headspeed as APS flight mode and GPS flight mode. (see page 26)

使用3GX飛行模式穩定起飛至空中停懸約30秒，接著慢速平穩降至地面後熄火，務必使用APS與GPS飛行模式所設定的Idel-up轉速執行震動測試。(請參考第 26)

Try to stabilize the helicopter's attitude and altitude as much as possible during vibration test; otherwise it may cause the test to fail.

震動測試過程中，請儘可能的穩定直昇機的姿態及高度，否則會導致無法通過震動測試。

3. Check LED1 and LED2

- Flashing green LED: Passed vibration test, APS LITE system can be used normally.
- Flashing red LED: Excessive vibration at APS LITE control unit location. Please eliminate vibration source, or relocate control unit to location with less vibration, or install the included meta plate on APS LITE control unit. Then perform vibration test again until it can be passed.

檢查LED1和LED2

- 閃爍綠燈：代表通過震動測試，可以正常使用APS LITE系統。
- 閃爍紅燈：代表APS LITE 控制器安裝的環境震動過大，請檢查並排除震動源或安裝在直昇機震動幅度較小的位置，或者在APS LITE 控制器下方黏上隨附鐵片，然後再做一次震動測試，直到通過震動測試為止。

4. When LED1 and LED2 flashes green indicating the pass of vibration test, the SET button must be pressed for APS LITE to record the event. APS LITE must pass vibration test and the event recorded before APS flight mode and GPS flight mode can be activated.

當LED1和LED2閃爍綠燈通過震動測試，需再按SET鍵讓APS LITE 記憶，APS LITE須通過震動測試且記錄測試結果，方能開啓APS 飛行模式與GPS 飛行模式功能。

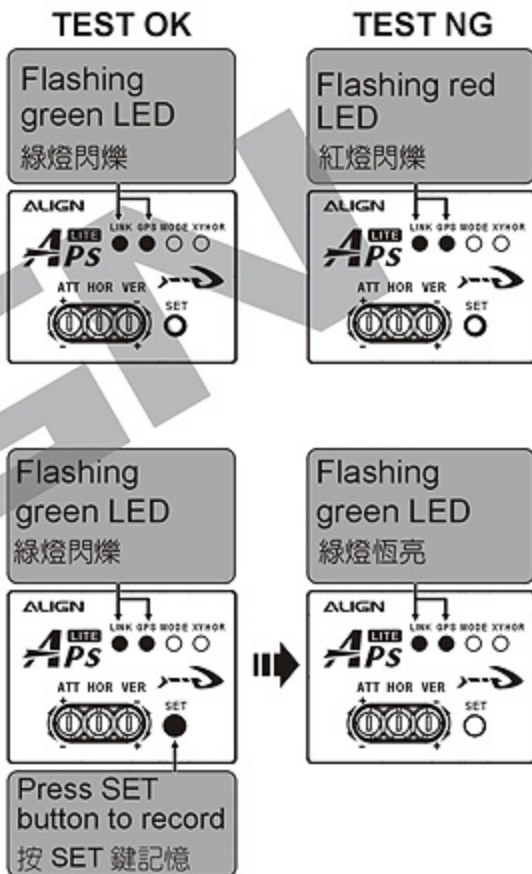
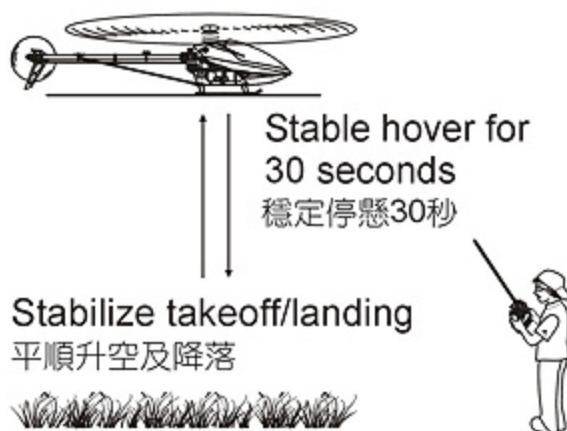

CAUTION 注意

If vibration test has not been passed, or SET button wasn't pressed to record the passing event, the LINK LED on APS LITE will light red when the power of gyro is on, and APS LITE function disabled. Should you try to switch 3GX flight mode into APS flight mode, the helicopter will wag its tail left/ right once, and remain in 3GX mode without going into APS flight mode.

如果沒通過震動測試或通過測試沒按SET鍵記憶，當APS LITE 陀螺儀電源開啓時，APS LITE 面板上的LINK燈會亮紅燈，並且會關閉APS 功能，此時當您從3GX飛行模式切到APS 飛行模式，直昇機會先左右擺動尾巴一次，然後維持原本3GX的飛行模式，不會進入APS 飛行模式，以確保安全。

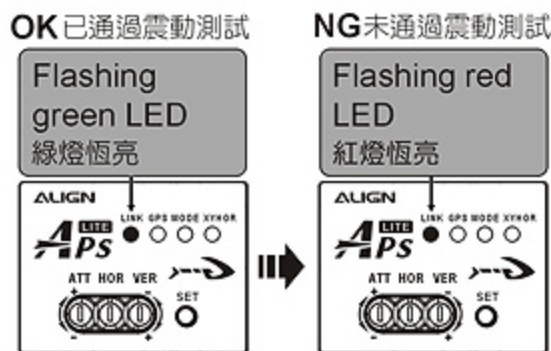

PRE-FLIGHT CHECK

飛行前檢查

ALIGN

After installing and setting the APS LITE Gyro per the instruction, there are certain pre-flight checks that must be performed before liftoff.

If LINK LED is red, this means the APS LITE system has not passed vibration test. Please execute the vibration test as discussed on page 31. Only after the vibration test has passed can APS LITE system be activated.

依照前面說明完成APS LITE 陀螺儀安裝與設定後，每趟飛行前務必要確實照著下列注意事項檢查，檢查無誤後才可以進行飛行。

如果LINK燈顯示為紅燈，表示APS LITE 陀螺儀未通過震動測試，請重新執行第31頁之震動測試，通過之後APS LITE 陀螺儀功能才會被開啓。

LED1. LED2.
LED4
Constant
Green
LED1. LED2.
LED4綠燈恆亮

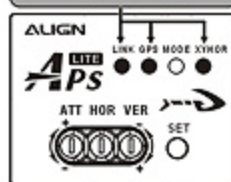

STEP

1. Confirm helicopter power source is removed, ensure rotor head will not spin up.
2. When helicopter electronics is powered up, swashplate will jump up and down 3 times just like before. Then check to ensure all LEDs on 3GX and APS LITE control unit do not indicate any error conditions (Refer to page 9 and 26). Power cycle the system or check APS LITE GYRO and 3GX settings are correct. Do not attempt to fly until error condition is resolved.
3. After heli electronics are powered up, the LINK and XYHOR LEDs on APS LITE control unit will lit green, GPS LED will lit red while acquiring satellite signals, and turns green when ready.
4. While in 3GX flight mode, check the helicopter's elevator/aileron/pitch/rudder are moving in the right direction. Then check the correct 3GX correction direction on elevator/aileron/rudder by tilting/yawing the helicopter.
5. Move transmitter throttle stick to center. Switch to APS flight mode and tilt the helicopter left/right/forward/backward, check if swashplate is compensating in the opposite direction as tilt. If compensation direction is incorrect, check APS LITE main control unit's install direction.

Note: When switching into APS flight mode on the ground for checking movement, it is normal for swashplate to tilt slightly.

步驟

1. 確認直昇機動力電源關閉，確保主旋翼不會旋轉。
2. 開啓直昇機接收電源，直昇機十字盤一樣會上下跳動三次，接著要檢查APS LITE 控制器與3GX 面板上燈號正不正確（參考第9及26頁），如有異常現象與燈號不正確的情況，勿冒然飛行，請重新開啓接收電源或檢查APS LITE 陀螺儀與3GX的設定是否正確。
3. 直昇機電源接收開啓後，APS LITE 控制器面板上的LINK燈與XYHOR燈會亮綠燈，GPS燈則會先亮紅燈待接收到衛星訊號後才亮綠燈。
4. 在3GX 飛行模式，檢查直昇機副翼、升降、螺距、尾舵動作是否正確；檢查3GX 副翼、升降、尾舵陀螺儀修正方向是否正確。
5. 將遙控器油門搖桿放置中間，接著切換至APS 飛行模式，前後左右搖晃直昇機，檢查十字盤修正的方向須和搖晃的方向相反，如果修正的方向不正確，則檢查APS LITE 控制器安裝的方向是否正確。

註：在地面上切入APS 飛行模式檢查動作時，十字盤不會是完全水平，會有些傾斜這是正常現象。

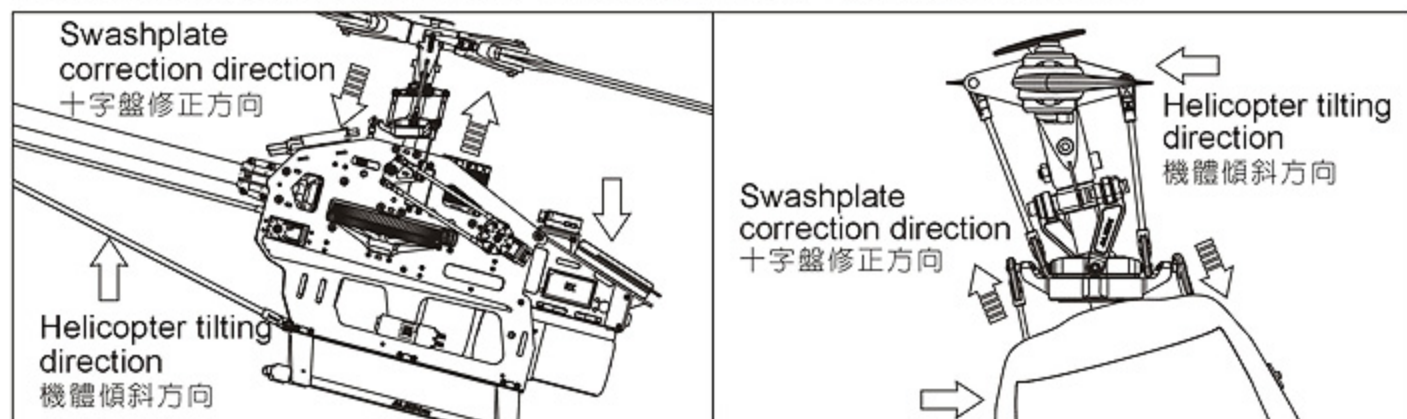

6. Move transmitter rudder stick to middle, rotate the helicopter clockwise and stop, and check if rudder is compensating left rudder. Then move transmitter rudder stick to middle, rotate the helicopter counter-clockwise and stop, and check if rudder is compensating right rudder. If compensating direction is incorrect, check APS LITE sensor's install direction, or the 3GX anti-torque compensation setting is set correctly (Please refer to rudder anti-torque compensation direction setting on page 22).

在APS飛行模式下，遙控器打Rudder將尾控制組移至中間，順時鐘將直昇機頭向旋轉一個角度停住，檢查尾舵是不是修正左舵，再用遙控器將尾控制組移至中間，逆時鐘將直昇機頭向旋轉一個角度停住，檢查尾舵是不是修正右舵，如果修正的方向不正確，請檢查APS LITE感應器的安裝方向是否正確，或3GX的尾舵反扭力補償設定是否正確(參第22頁尾舵反扭力補償正反向設定)。

Rudder control compensation direction 尾控制組修正方向

Tail movement direction
尾部移動方向

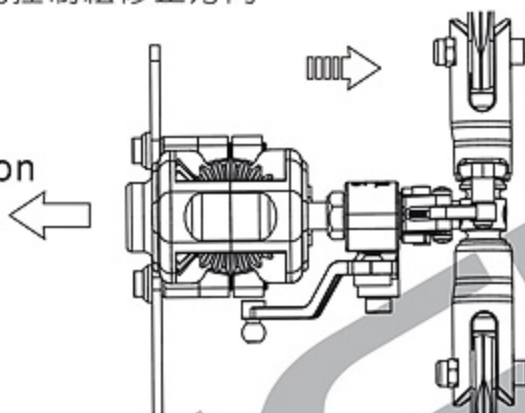

7. Move all transmitter sticks to the middle, and move the helicopter in and up/down motion while observing swashplate movement to ensure it's moving the opposite direction for proper correction. If correction direction is incorrect, check if speed governor throttle curve is setup within the 3GX.

- Throttle stick must be centered before switching into APS flight mode; otherwise it will not be possible to determine if pitch compensation is working in the correct direction.
- When checking for pitch compensation direction, you can lightly rest finger on the swashplate and feel downward motion when helicopter is moved upwards.

將遙控器所有搖桿放置中間，上下移動直昇機，檢查十字盤上下修正的方向必須要與移動的方向相反。如果修正的方向不正確，請檢查3GX有沒有設定定速功能中的油門行程校正。

- 一定要先將油門搖桿放置中間，再切換至APS飛行模式，否則無法確認十字盤上、下修正方向是否正確。
- 檢查十字盤上下修正方向，可以利用手指輕放在十字盤上。水平上移直昇機時手指可感受十字盤下移修正。

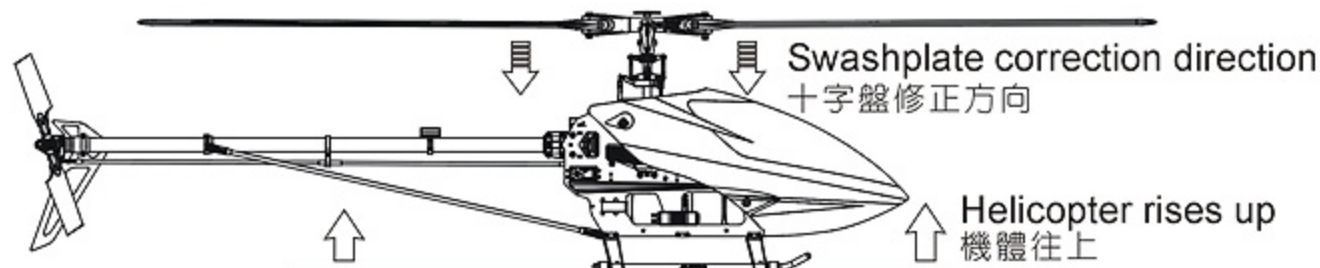

8. If all of above tests are normal, re-power and wait GPS signal to turn green, and helicopter will be able to switch to APS flight mode after liftoff.

若以上檢測都正常，請重新接電並等待GPS訊號指示燈變為綠燈，才能將直昇機起飛並切入APS飛行模式。

SENSITIVITY SETTINGS

感度旋鈕設定

ALIGN

1 ATTITUDE GAIN AND LEVEL GAIN ADJUSTMENT

姿態感度和水平位置感度調整

Because Position and Attitude both will affect the position holding capability, as the two are interrelated, it needs to be adjusted by the pilot based on individual preferences.

- Adjustment of attitude gain will affect helicopter's response speed in movement and stoppage. Increase of attitude gain will result with more obvious oscillation of the helicopter.
- Adjustment of level position gain will affect the helicopter's hovering capability. Excessive gain will result in oscillations during hover, while insufficient gain results in less anti-wind gust ability during hover, causing drifts induced by wind.

因為姿態感度和水平位置感度都會影響定位控制的效果，兩者的關係是相輔相成的，需要使用者各自調整，找出合適自己的飛行手感。

- 調整姿態感度會影響直昇機移動、停止的反應速度，如果姿態感度提高，相對的直昇機的晃動會比較明顯。
- 調整水平位置感度會影響直昇機停懸的效果，過高的感度會造成停懸時晃動的情況比較嚴重，而過低的感度會造成停懸時沒有辦法抵抗強風的干擾，造成停懸的位置會隨著風而改變。

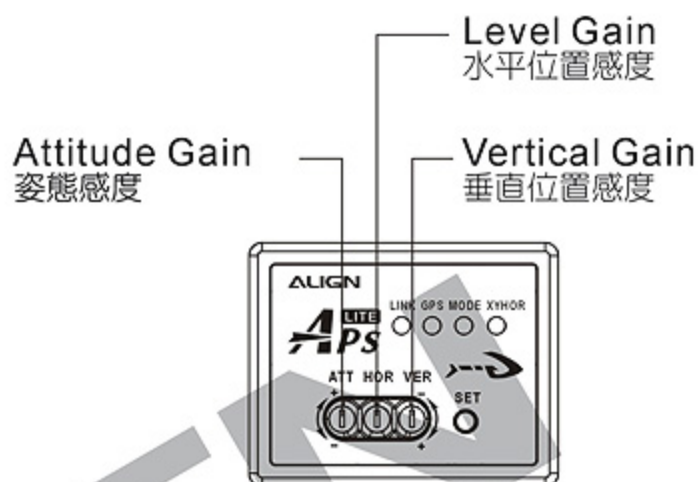

CAUTION 注意

All gain settings are default at 12 o'clock position. Clockwise to increase the gain, counter-clockwise to decrease. Factory default settings is suitable for most helicopters, and is recommended.

所有感度的預設位置為12點鐘方向，順時鐘旋轉感度變高，逆時鐘旋轉感度變低。預設的感度經由測試適用大部分機體，建議使用預設值。

2 VERTICAL POSITION GAIN SETTING

垂直位置感度調整

STEP

1. Switch into APS flight mode after lift off.
2. Ascend the heli quickly followed by a sudden stop.
3. Observe the up/down oscillation of helicopter after stop.
4. For large oscillation, reduce vertical gain.
5. Repeat step 2 to 3 until there are no oscillations after stop.

步驟

1. 將直昇機起飛後切入APS飛行模式。
2. 控制直昇機往上升，然後快速停住。
3. 觀察直昇機停止時的上下震盪現象。
4. 若上下震盪的幅度很大，代表感度過高，將高度的感度調低。
5. 重複步驟2和3直到直昇機快速停止時不會有震盪現象。

3

CONTROL FEEL ADJUSTMENT UNDER APS MODE

APS模式操控手感調整

Attitude Gain 姿態敏感度		Low Gain 低敏感度	High Gain 高敏感度
 <p>(Low) (High)</p>	Heli Response 機體反應	Smoother attitude correction by APS 機體回復成水平姿態的動作較為滑順緩慢。	Harder attitude correction by APS 機體回復成水平姿態的動作較為紮實迅速。
	Control Feel 操控手感	Attitude control and control direction change is slower, fuzzy, and softer. 操控機體姿態與變換移動方向時的反應較為延遲及模糊柔和。	Attitude control and control direction change is more direct and more precise. 操控機體姿態與變換移動方向時的反應較為直接及細膩精確。
	Application 應用範圍	1. Higher gain should be used under strong gust condition to enable immediate attitude compensating reaction. 2. For aerial photography, adjust ATT gain to achieve the desired control feel. 1. 強風環境下須調高敏感度，使姿態修正及時反應。 2. 進行空中攝影時，可依據操控手感調整姿態敏感度。	

Level Gain 水平位置敏感度		Low Gain 低敏感度	High Gain 高敏感度
 <p>(Low) (High)</p>	Heli Response 機體反應	Slower and more fuzzy positioning of the helicopter by APS. 機體定位緩慢，保持位置時略為飄移，定位時機體修正反應較為緩和。	Faster and more precise positioning of the helicopter by APS, possible horizontal twitching during positioning. 機體定位迅速，保持位置較為精準，定位時機體會抖動現象。
	Control Feel 操控手感	Less positioning intervention during control. 操控時定位介入較弱。	More positioning intervention during control. 操控時定位介入較多。
	Application 應用範圍	1. Higher gain should be used under strong gust condition to allow for more precise positioning. 2. For aerial photography, adjust the HOR gain can be lowered to maintain smooth control feel. 1. 強風環境下須調高敏感度，使定位更精確。 2. 進行空中攝影時，可調低敏感度，保持較滑順的操控手感。	

Vertical Gain 垂直位置敏感度		Low Gain 低敏感度	High Gain 高敏感度
 <p>(Low) (High)</p>	Heli Response 機體反應	Slower height compensation, longer time before compensation. 修正高度緩慢，高度變化時介入修正時間較為緩慢。	Faster height compensation, possible vertical twitching during compensation. 修正高度迅速，修正時機體會垂直跳動現象。
	Control Feel 操控手感	Softer stop during altitude changes 改變高度時緩停。	Harder stop during altitude changes 改變高度時急停。
	Application 應用範圍	Higher gain should be used under strong gust condition 強風環境下需要較高的高度修正敏感度。	

HEADING DIRECTION GAIN ADJUSTMENT

頭向感度調整功能

ALIGN

Should the helicopter exhibits tail hunting while flying under APS mode, this adjustment can be used to adjust the APS heading gain.

在APS飛行模式下，若出現尾舵追蹤現象，可以透過此功能來調降APS頭向感度。

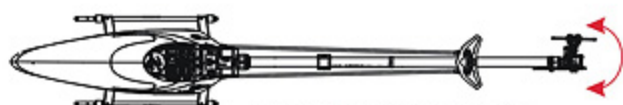

Heading Direction
Gain Adjustment
頭向感度調整

CAUTION 注意

1. Should there already exist tail hunting issue under 3GX mode, APS heading gain will not eliminate such hunting. Please adjust the rudder gyro gain in radio transmitter under 3GX flight mode, and eliminate possible mechanical binding which may affect tail responsiveness.
2. Insufficient APS heading gain may cause rudder drift while in APS flight mode, Please increase gain.
1. 若在3GX飛行模式下尾舵已經呈現追蹤現象，APS頭向感度並不會消除尾舵追蹤。請先透過遙控器調整3GX飛行模式下的鎖定感度，並先行排除機械干涉所造成的不正常尾舵反應。
2. APS頭向感度不足時會導致在APS飛行模式時產生尾舵飄移的現象，請調高感度。

STEP 步驟

1. After APS LITE finished powering up, push the rudder stick on your transmitter all the way left or right, and press the SET button on APS LITE to enter APS heading gain adjustment mode.

在APS LITE 完成開機的狀態下，將遙控器尾舵搖桿撥至左邊或右邊不放，再按一下APS LITE 設定鍵進入APS 頭向感度設定模式。

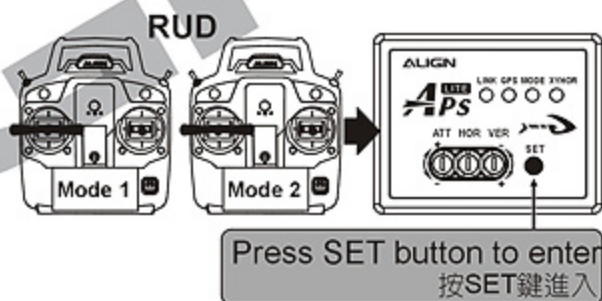

Press SET button to enter
按SET鍵進入

2. After entering APS LITE heading gain adjustment mode, APS indicator LEDs will display the current gain value, factory value is set to 2 LEDs steady lit.

進入設定後APS LITE顯示燈號會顯示當前的頭向感度設定，初始設定值為2個LED燈全亮。



3. Move the rudder stick to change the gain value. More LED's means higher gain, less LED's mean less gain, with total of 8 gain values. Reduce gain value should there be any tail hunting effect.

撥動尾舵搖桿來更改頭向感度設置，感度設置提供8個區段調整範圍。

燈號愈多感度愈高，反之燈號愈少感度愈小，若有尾舵追蹤現象，請調低感度。

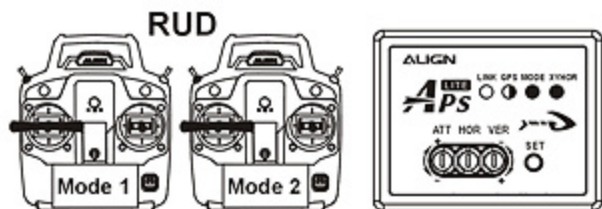

4. After completing gain adjustment, press the SET button on APS once to exit.

設定完成後，按一下APS LITE 設定鍵記錄設定並退出APS頭向感度設定模式。



Press SET button to record
按SET鍵記錄

CONTROL MODES

操作模式

ALIGN

There are 3 modes when APS LITE is used with 3GX: 3GX flight mode/ APS flight mode/ GPS flight mode.

3GX整合APS LITE 陀螺儀之後，共具有以下三種飛行操作模式：3GX 飛行模式/ APS 飛行模式/ GPS 飛行模式。

3GX Flight Mode 3GX 飛行模式	APS Flight Mode(page 39) APS 飛行模式(請參考第39頁)	GPS Flight Mode(page 44) GPS 飛行模式(請參考第44頁)
<p>3GX flight mode is the standard 3GX flight mode where all control characteristics and gain settings are identical to as if APS wasn't installed. APS gyro will not attempt to correct any flight maneuvers.</p> <p>3GX 飛行模式，即為可執行原始3D飛行性能的3GX無平衡系統模式，在此模式下APS陀螺儀不會介入修正任何的飛行動作。</p>	<p>While in APS flight mode, helicopter can hold position/attitude/altitude. Following functions are possible under this mode:</p> <ul style="list-style-type: none"> ● Semi-autonomous takeoff/landing(page 40) ● GPS position attitude hold (page 41). ● Emergency bailout(page 41) ● Failsafe protection (page 46). <p>在APS飛行模式下，直昇機可以自動保持位置、姿態及高度。此模式具有以下功能。</p> <ul style="list-style-type: none"> ● 半自動起飛/降落(請參考第40頁) ● GPS 定位與姿態保持(請參考第41頁) ● 緊急姿態平衡(請參考第41頁) ● 失控保護(請參考第46頁) 	<p>While in GPS flight mode, the following functions are possible:</p> <ul style="list-style-type: none"> ● Return home(page 45) <p>在GPS飛行模式下，藉由GPS訊號定位，具有以下功能。</p> <ul style="list-style-type: none"> ● 自動返航Home點(請參考第45頁)



SAFETY REMINDERS

安全注意事項提醒

- This product is intended for those with prior experiences with RC helicopter. Do not attempt to operate or fly if you are not familiar with this product.
- Do not modify or alter this product in any way. Full visual contact of the helicopter must be maintained during flight. The use of this product for illegal purposes is strictly prohibited. Please follow local law and regulations and do not fly in restricted air space.
- Vibration test must be passed prior to initial flight (page 31). The use of APR and GPS flight modes without passing vibration test may result in crash and other unforeseen consequences.
- Pre-flight checks must be performed before every flight (page 33).
- Avoid flying near obstacles and crowds of people. Avoid improper control, environment induced radio interference, or electronics failures which may cause injuries and/or loss of property on yourself and others. As the operator of this product, you are solely responsible for the surrounding and full liability.

- Even though the helicopter is able to fly autonomously (APS flight mode or GPS flight mode), pilot must maintain full visual contact of the helicopter during flight. Should the helicopter experience any problems during flight, immediately switch back to 3GX mode and fly manually.
- Flying in rain, lightning and thunder, or any other extreme weather is prohibited. GPS satellite signal may also be affected by extreme weather leading to possible loss of function.
- To ensure autonomous flight path will not near crowds of people and obstacles, user must be conscious of the Home location and maintain a certain safety distance.
- 本產品是提供給有操作模型直昇機技術經驗的人員使用，在不熟悉本產品操作之前請勿任意操作及飛行。
- 請勿自行改造、加工本產品，並在視線範圍內操作直昇機，嚴禁作為其他非法用途，並遵守當地法令勿在航空管制範圍內飛行。
- 飛行前務必要執行與通過APS震動測試(請參考第31頁)，否則冒然的開啓APS與GPS飛行模式，會造成直昇機失控墜毀和其他不可預期的危險。
- 飛行前務必要確實執行飛行前檢查(請參考第33頁)，檢查無誤後方可飛行。
- 飛行時直昇機應遠離障礙物及人群，避免操控不當、環境干擾電子設備，或機件故障造成自己與他人生命財產的損失，做為本產品的使用者，您，是唯一對於您自己操作的環境及行為負全部的責任之人。
- 即使直昇機進入定位飛行(APS飛行模式)或自動駕駛功能(GPS飛行模式)，使用者仍全程目視直昇機飛行，在飛行過程中有任何異常狀況，須立刻切換回3GX飛行模式，改由手動操作。
- 禁止在下雨、狂風、打雷等惡劣天候下操作，以確保自身與機體的安全，GPS衛星訊號會因天候不佳而影響定位的準確度，甚至失去定位功能。
- 使用者必須記住返航點(Home)的明確位置，確保進入自動駕駛功能時，直昇機的飛行路徑不會靠近人群與撞擊障礙物，並且保持一定的安全距離。

APS FLIGHT MODE

APS 飛行模式

APS



注意

We suggest that once the helicopter is airborne, please choose the best hovering height first and switch to APS flight mode. The current position and altitude will be registered as home point that helicopter return when failsafe activated. Succeeding mode changes into APS Flight mode will not replace the home location originally registered.

After powering off APS LITE, all waypoints and home location will be cleared. Both home and waypoint must be set again during next flight session.

建議！當每次直昇機升空後，請先執行確認選擇您認為最適當的停懸高度位置，然後執行撥桿切換為APS飛行模式，APS LITE陀螺儀會自動記錄當時的高度與位置，以作為失控保護返航時的Home點記憶位置，爾後不論於飛行中切換至APS飛行模式的次數多寡，皆不會取代第一次切換至APS飛行模式的Home點記憶位置。

當關閉接收器電源後，Home點會被清除，使用者下一趟飛行時，須重新設定Home航點。

Under APS flight mode, transmitter command is speed commands to control helicopter's speed in 6 directions (forward, backward, left, right, up, down). When transmitter stick is in the middle, speed command is zero, APS will automatically hold its position. In another word, pilot does not have to care about current helicopter's attitude, and can directly use the transmitter control sticks to issue flight commands to helicopter.

在APS飛行模式下，遙控器的命令為速度指令，即操作直昇機六個方向(前進、後退、左移、右移、上升、下降)的速度，當遙控器搖桿都在中間置中時，速度指令都為零，APS LITE 會自動保持直昇機位置、姿態、高度不變的穩定停懸。簡單說，玩家可以完全不管直昇機的姿態如何，直接利用遙控器搖桿來給直昇機飛行指令。



注意

- During power up, wait for GPS status LED to turn green before entering APS flight mode.
- Position hold performance is dependent on satellite signal. Should GPS lose satellite signal while in-flight, APS LITE will automatically switch to attitude mode. While the helicopter may drift in a direction under attitude mode, it will still remain level and maintain altitude. This is a safety feature to prevent unintentional flip of helicopter during loss of satellite signal.

- After powering off receiver, all waypoints and home location will be cleared. Both home and waypoint must be set again during next flight session.
- Should helicopter experience any unusual behavior during APS flight mode, you must switch back to 3GX mode immediately and fly manually to ensure safety.
- 剛開機時，請等待GPS狀態指示燈變為綠燈，才能進入APS飛行模式。
- 定位的性能依照衛星訊號狀況不同會有所差異，若飛行中GPS失去衛星訊號無法定位時，APS LITE 會自動切換成姿態模式，在此模式下直昇機可能往某一方向水平飄移，但仍可保持姿態水平與高度不變，這是為了確保飛行中失去衛星訊號時，直昇機不會翻覆的保障機制。
- 當關閉接收器電源後，所有導航點與Home點都會被清除，使用者下一趟飛行時，須重新設定Home點與導航點。
- 在APS飛行模式下執行任何飛行功能時，若直昇機發生異常狀況，務必立刻恢復3GX飛行模式，改為手動操作，以確保安全。

1 SEMI-AUTONOMOUS TAKEOFF 半自動起飛

APS

Switch to APS flight mode while in normal mode, and slowly raise the throttle stick. Helicopter will stabilize and lift off. Please set the pitch curve in normal mode according to instruction found in page 26.

油門曲線為Normal狀態下，切入APS飛行模式然後緩緩推油門搖桿，直昇機就會自動穩定姿態起飛。Normal螺距曲線請參照第26頁設定。



The first time semi-autonomous takeoff is executed, the Home location will be registered as 3meters above the takeoff point. Therefore, to ensure the safety during return home function, make sure there are no crowds of people or obstacles within 10meters radius of this point.

第一次執行半自動起飛功能時，自動返航Home點會定義在起飛點上方約3公尺的高度，所以使用者須確保起飛點直徑10公尺以內的空域無人群及障礙物，以確保直昇機執行自動返航時之安全性。

Step.1

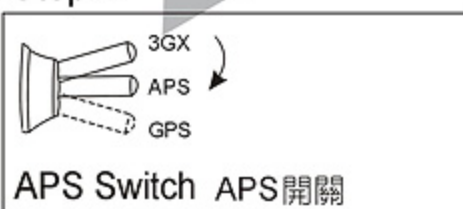

Step.2



2 SEMI-AUTONOMOUS LANDING 半自動降落

APS

While in APS flight mode, first switch throttle curve from Idle-up back into normal, and then slowly lower the throttle stick to descend the helicopter. After helicopter has landed, switch back from APS flight mode to 3GX flight mode.

在APS飛行模式下，先將油門曲線由Idle-up切回Normal狀態，然後慢慢將油門搖桿往下拉，讓直昇機緩緩降落，當直昇機降落完成必須將飛行模式切換開關由APS飛行模式切換回3GX飛行模式。



If APS is not switched back to 3GX mode after semi-autonomous landing, due to incorrect offset value of magnetometer, APS may experience abnormal attitude detection during the next flight and result in incorrect movement compensation.

半自動降落後，如未返回3GX飛行模式而以APS飛行模式再次半自動起飛時，會因GPS誤差與起飛離地前的震動造成起飛姿態判別異常，而發生危險。

Step.1

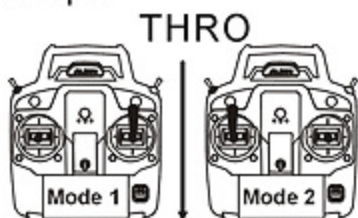

Step.2

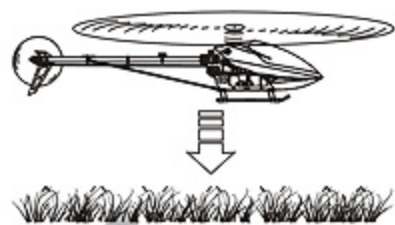
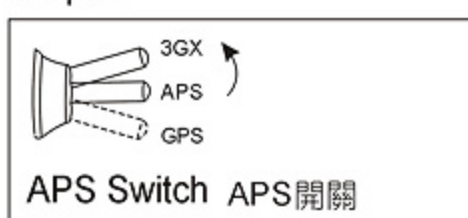

3 GPS POSITION ATTITUDE HOLD

GPS 定位與姿態保持

APS

When switched from 3GX flight mode to APS flight mode, APS LITE gyro will assist in helicopter attitude stabilization, position hold, and altitude hold flight. The RC transmitter can also control helicopter's flight path.

從3GX 飛行模式進入APS 飛行模式，APS LITE 陀螺儀會輔助直昇機穩定姿態、定位、定高度飛行。

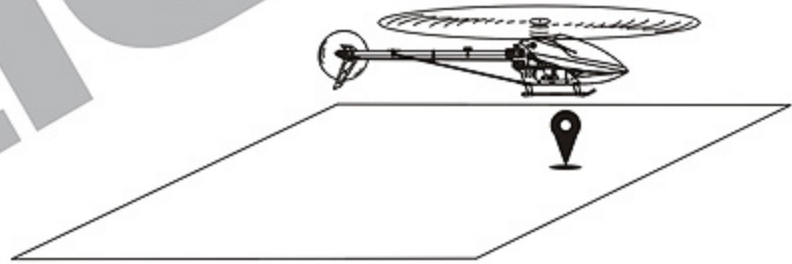
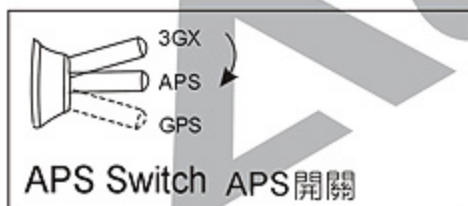

Helicopter attitude stabilization, position hold, and altitude hold flight
定位、定姿態、定高度飛行

4 EMERGENCY BAILOUT

緊急姿態平衡

APS

The primary purpose of this function is for saving and stabilizing an out of control helicopter. While the pilot flies the helicopter right side up or inverted in 3GX flight mode, should loss of orientation, instability, or loss of control is experienced, pilot can switch to APS flight mode, and the APS LITE gyro will flip the helicopter right side up, stabilize, and hold position.

此項功能主要是用在直昇機操控不當時，救機／穩定直昇機用，當操控者在3GX飛行模式下，正飛或倒飛姿態，如遇到無法穩定控制直昇機的飛行狀況，可將飛行模式切換到APS飛行模式，APS LITE 陀螺儀會自動將直昇機翻正、回穩且定位飛行。

- When helicopter's attitude is not stable, switch to APS flight mode will enable APS LITE to immediately stabilize helicopter. **(Caution! Please always keep the flight height for 5M or higher.)**
- 在一般航道飛行時，如遇到無法掌控直昇機的飛行狀況時，進入APS 飛行模式，APS LITE 會馬上把機體回穩且定位飛行。（注意！5公尺以上安全飛行高度是必要的）



Do not perform violent 3D or roll/flip maneuvers 30 seconds prior to switching into APS mode, otherwise it may cause abnormal attitude detection by the APS and result in incorrect compensation and crash.

This function should be used when helicopter is 20M or farther away from the pilot, and with minimum of 5M altitude.

使用此項功能前30秒內請勿執行劇烈3D與翻滾動作，否則會導致APS姿態判別異常，造成直昇機失控。

使用此項功能時，直昇機須距離操控者與人群20公尺以上安全距離，且離地高度5公尺以上的安全高度。

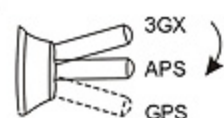

APS Switch APS開關

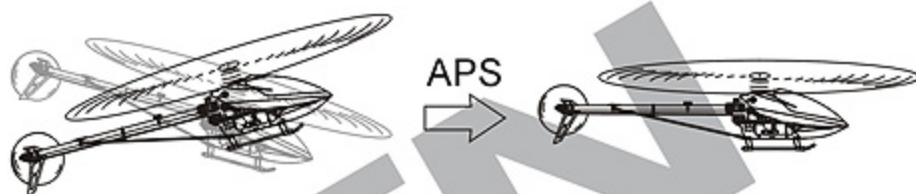

- While doing inverted flight in 3GX Flight mode, switch to APS Flight mode will enable APS LITE to immediately flip the helicopter right side up and stabilize it.
- 在3GX 飛行模式倒飛的姿態下進入APS 飛行模式，APS LITE 會把直昇機原地翻正回穩且定位飛行。



Do not use this function repetitively without a 30 seconds interval, otherwise it may cause abnormal attitude detection by the APS and result in incorrect compensation and crash.

This function should be used when helicopter is 20M or farther away from the pilot, and with minimum of 5m altitude.

連續使用此功能時，須間隔30秒以上，否則會導致APS姿態判別異常，造成直昇機失控。

使用此項功能時，直昇機須距離操控者與人群20公尺以上安全距離，且離地高度5公尺以上的安全高度。



APS Switch APS開關

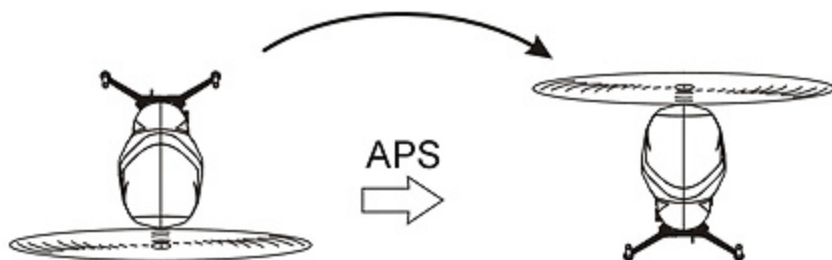

5 DESCEND DECELERATION SYSTEM 降落自動減速功能

APS

APS LITE system provides automatic landing safety deceleration system. While in APS flight mode, when pilot performs landing routine, to avoid crash as result of excessive descend speed, APS LITE will automatically reduce the descend speed to 2M/sec when the aircraft's altitude is between 10M and 5M, and lower to 0.8M/s when below 5M.

APS LITE 具備降落自動減速功能，在APS飛行模式下，當操控者下達下降指令時，為避免直昇機下降速度過快而剎車不及，在距離地面高度10公尺到5公尺之間APS LITE 會自動把速度減速到每秒2公尺的下降速度，距離地面5公尺以下會減速到每秒0.8公尺的下降速度。



注意

1. APS LITE uses the elevation where the system was powered up as 0 altitude, not sea level elevation.

2. If APS LITE is to be armed at higher elevation, and then flown into lower elevation environment, we recommend disabling this feature to achieve faster descent rate.

1. 飛行高度是以APS LITE 開機的地理位置為初始高度(0公尺)，而不是海拔高度。

2. 若在較高的地理位置將APS LITE 開機，欲飛行至相對較低高度的環境時，建議關閉此功能以獲得更快的下降速度。

STEP 步驟

1. After APS LITE system powers up, move the elevator stick up or down and hold in position, press SET button on APS LITE to enter setup mode for automatic landing safety deceleration system.

在APS LITE 完成開機的狀態下，將遙控器升降搖桿撥往上或往下不放，再按一下APS LITE 設定鍵進入降落自動減速功能設定模式。

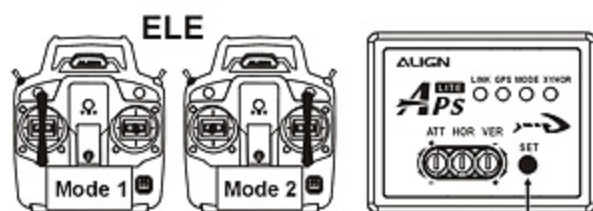

Press SET button to enter
按SET鍵進入

2. After entering setup mode, the LINK and GPS LED's will both lit either green or red; green indicates automatic landing safety deceleration system is active, red means it's disabled.

Factory value is active.

進入設定後APS LITE 的LINK與GPS兩個燈號會同時恆亮綠燈或者紅燈，亮綠燈表示降落自動減速功能開啓，紅燈表示降落自動減速功能關閉，預設值為開啓。

Red LED : Deactivate
Green LED : Activate
紅燈代表關閉：綠燈代表開啓



3. Move elevator stick to change the LED's color to correspond to active/disable of the automatic landing safety deceleration system.

撥動升降搖桿來更改燈號顯示，關閉或開啓降落自動減速功能。

Red LED : Deactivate
Green LED : Activate
紅燈代表關閉：綠燈代表開啓

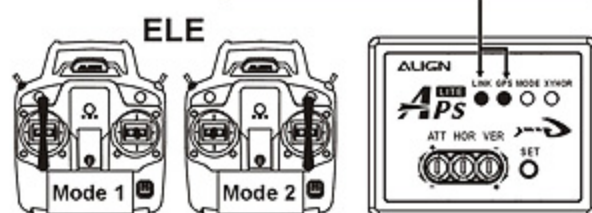

4. Press the SET button on APS LITE to register the change and exit automatic landing safety deceleration system mode.

設定完成後，按一下APS LITE 設定鍵記錄設定並退出降落自動減速功能設定模式。



Press SET button to record
按SET鍵記憶

GPS FLIGHT MODE

GPS 飛行模式

GPS

Under GPS flight mode, APS LITE is able to execute return home function.

在GPS飛行模式下，APS LITE 可執行自動返航Home點功能。



While executing GPS flight mode, please keep the helicopter in sight at all times. Should helicopter experience any type of abnormalities, switch back to 3GX mode immediately to regain manual control.

This function should be used when helicopter is at least 20meters from the pilot, and with minimum altitude of 5meters.

在GPS飛行模式下若直昇機發生異常狀況，務必立刻恢復3GX飛行模式，改為手動操作，以確保安全。

使用此項功能時，直昇機須距離操控者與人群20公尺以上安全距離，且離地高度5公尺以上的安全高度。

1 RETURN HOME

自動返航Home點

GPS

Once the helicopter is airborne and APS flight mode is switched on the first time, the current position and altitude will be registered as home point. Succeeding mode changes into APS flight mode will not replace the home location originally registered(see page 40). After powering off receiver, all waypoints and home location will be cleared. Both home and waypoint must be set again during next flight session.

When flight mode is switched from APS flight mode to GPS flight mode, 3 seconds later the helicopter will begin executing return home function. During return home, helicopter will rise 10m from current altitude, turn its head toward the home location, and then slowly fly back home. When arrived at home location, helicopter will ascend/descend to the pre-determined altitude. All RC commands from transmitter will be ignored unless you switch back to APS flight mode.

If the home altitude is set as less than 3M, the actual return home altitude will be override to around 3M as a safety feature.

直昇機於升空後，第一次將撥桿切換APS飛行模式時，APS LITE 陀螺儀會自動紀錄當時的位置與高度，作為返航Home點，爾後不論於飛行中切換至APS飛行模式的次數多寡，皆不會取代第一次切換至APS飛行模式的Home點記憶位置，當關閉接收器電源後，所有導航點與Home點都會被清除，使用者下一趟飛行時，須重新設定Home點與導航點。(半自動起飛功能的Home點位置請參考第40頁)

當飛行模式操作開關由APS飛行模式切換至GPS飛行模式三秒鐘之後，直昇機就會開始執行自動返航功能。執行自動返航時，直昇機會從執行返航的位置自動先往上爬升10公尺的高度，接著將直昇機的頭轉向Home點，然後慢速的直線航行至Home點，最後會將高度上升或下降至Home點的設置高度。返航途中，所有遙控器的指令皆無效，須切回APS飛行模式才能由遙控器控制。

若返航點與地面的高度距離在3公尺以下時，直昇機返航的最後高度會控制在距離地面3公尺左右，以確保安全。

Navigation Flight Speed 導航飛行速度	When 50m from next waypoint	27km/hr	距指定點50公尺以上	27km/hr
	When 50m~20m from next waypoint	18km/hr	距指定點50~20公尺	18km/hr
	When within 20m from next waypoint	9km/hr	距指定點20公尺以下	9km/hr
Descend speed during automatic return home 自動返航下降速度	When more than 20M away from home point	18km/hr	距Home點高度20公尺以上	18km/hr
	When more than 20M away from home point	3.6km/hr	距Home點高度20公尺以下	3.6km/hr

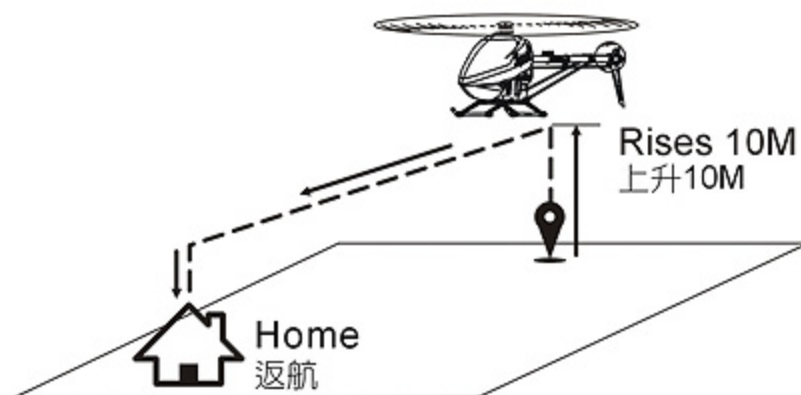
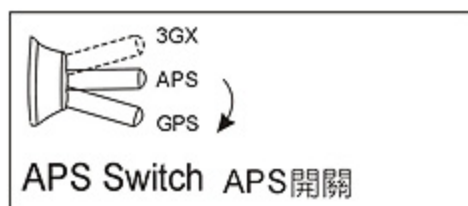

2 FAILSAFE PROTECTION 失控保護

GPS

When helicopter lose RC signal under APS or GPS flight mode, APS will take over and fly the helicopter back to HOME automatically. When the helicopter entered return home mode, please set the APS switch to the GPS flight mode position. If you want to cancel the return home command when the helicopter arrived or on the way to the HOME, you can switch to APS mode to hold the helicopter in position or switch to 3GX mode for manual control. (To register home point, please refer to "RETURN HOME" on page 45)

當直昇機於APS或GPS飛行模式下失去遙控器訊號，無法控制時，APS陀螺儀會開啓失控保護功能，使直昇機自動返航至Home點，直昇機自動進入返航指令時，須先將APS開關置於GPS飛行模式的位置，若抵達Home點或返航途中，要解除自動返航指令時，可切入APS模式使直昇機定位停懸或切入3GX飛行模式改由手動操作。（Home點設置請參考45頁，自動返航Home點）

CAUTION 注意

- Base on safety issue, Failsafe is not functional under 3GX flight mode.
- Helicopter will return home when signal lost if the user didn't set up Failsafe and the home point.
- 基於安全因素，在3GX飛行模式下不支援失控保護功能。
- 使用者若未設置失控保護功能與返航Home點時，將無法使用直昇機於訊號失控時自動返航。

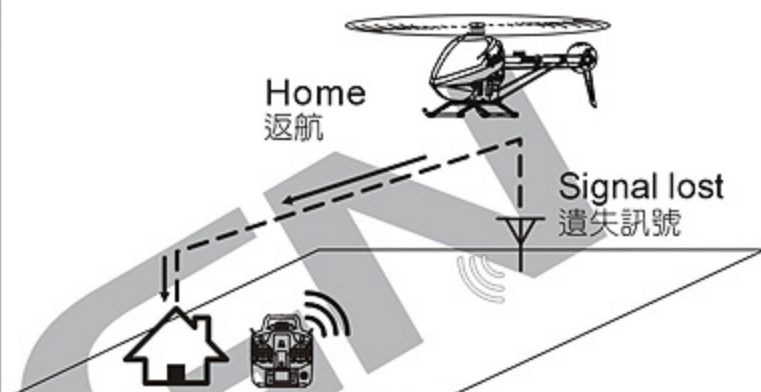

APS LITE CONTROL UNIT LED DISPLAY APS LITE 控制器指示燈說明

ALIGN

1 APS LITE WORKING MODE APS LITE工作模式

	LED1 LINK 3GX 連線指示燈	LED2 GPS GPS 狀態燈	LED3 Mode 操作模式燈	LED4 XYHOR 姿態指示燈
Green 綠燈	3GX connected 與3GX 連線成功	GPS Signal Ready GPS 定位完成	APS flight mode APS飛行模式	APS controller is leveled 水平
Flashing Green 綠燈閃爍	—	—	GPS flight mode GPS飛行模式	—
Light off 熄滅	Connection failure 3GX 連線失敗(*1)	APS sensor not connected 未連接APS 感應器	3GX flight mode 3GX飛行模式	APS controller is not leveled 不水平
Red 紅燈	Vibration test failed 震動測試失敗	Searching GPS signal GPS 訊號定位中	—	—
Flashing Red 紅燈閃爍	Power-on failure (Please restart) 開機失敗 - 重新開機 (*2)	—	—	—

During power up, GPS system requires some time to lock in signal. Signal acquisition is quicker if in wide open space. If the helicopter is indoor or in area with weak GPS reception, only attitude and altitude control is available.

(*1) Check proper connection on 3GX. (*2) Do not move the APS LITE modules during power up.

剛開機時，需要一段時間接收GPS訊號，如果在空曠的地方，一陣子後就會變成綠燈。若在室內或GPS訊號較弱的地方，沒有足夠穩定的資訊，就只有姿態和高度控制。

(*1) 請檢查3GX是否連接正確。 (*2) 開機時請勿晃動APS LITE 控制器。

2 CALIBRATION MODE

磁力計校正模式

	Calibration Mode 進入磁力計校正模式
LED1 Red LED1紅燈	Rotate helicopter on horizontal axis 水平旋轉直昇機
LED1 and LED2 Red LED1 和 LED2 紅燈	Nose up, rotate helicopter on vertical axis 機頭朝上，水平旋轉直昇機
LED1 and LED2 Green LED1 和 LED2 綠燈	Calibration completed, restart system 校正完成，請重機開機

Note: Regular LED indication is not used under calibration mode.

註：校正模式下，3GX 飛行模式的LED指示皆不適用。

3 VIBRATION TEST MODE

震動測試模式

Flashing green LED1 and LED2 LED1、LED2綠燈閃爍	Vibration test passed 震動測試通過
Flashing red LED1 and LED2 LED1、LED2紅燈閃爍	Vibration test failed 震動測試失敗

4 UPDATE MODE

更新模式

LED1	Flashing green 綠燈閃爍
LED2、LED3、LED4	Off 恆暗

SPECIFICATIONS

產品規格

ALIGN

Operating voltage range 適用電壓	DC3.5V~8.4V
Operating current consumption 消耗電流	<200mA@ 4.8V
Operating Temperature 工作溫度	-20 ~ 65 °C (-4 ~ 149 °F)
Hovering Precision (Depending on satellite status) 停懸精度 (受衛星狀況影響)	- Horizontal ±1m(3.28ft) - 水平 ±1公尺 - Vertical ±1m(3.28ft) - 垂直 ±1公尺
Highest flight speed 最大飛行速度	- Horizontal 36km/hr(22.37mph) - 水平 36公里/小時 - Vertical 18km/hr(11.18mph) - 垂直 18公里/小時
Maximum altitude restriction 飛行高度限制	500m(1640ft) above the takeoff point 距起飛點上方500公尺
APS LITE Control unit Dimension/ Weight APS LITE 控制器尺寸/ 重量	35.4x27.9x17mm/ 14.8g (1.393x1.098x0.669in/ 0.032lb)
APS Sensor Dimension/ Weight APS感應器尺寸/ 重量	29.5x26.3x10.8mm/ 12.7g (1.161x1.035x0.425in/ 0.028lb)

Q&A 1 **After powering up, why is the LINK LED showing red on APS LITE ?**
This is due to the heli not passing the vibration test. Please perform the vibration test again, and press the SET key after passing for APS LITE to register the test result.

為何開機後，APS LITE 上LINK燈一直顯示為紅燈？

這表示直昇機未通過震動測試，請重新再執行震動測試，通過後務必要按SET鍵使APS LITE 記錄測試結果。

Q&A 2 **Why is the heli unable to hold position after switching to APS Flight mode, and exhibits obvious erroneous movements?**
This mean your headspeed in the APS Flight mode differs than the headspeed during vibration test. Please revert to the original headspeed, or perform the vibration test steps again with the new headspeed.

為何進入APS飛行模式直昇機會無法定位，且出現明顯的異常動作？

這表示APS飛行模式的轉速與當時通過震動測試的轉速不同，請調回當初振動測試的轉速或調低轉速重新執行通過震動測試即可。

Q&A 3 **Can I perform semi-autonomous takeoff using APS LITE ?**
Yes. Wait for GPS LED to turn steady green, lower throttle to lowest point and switch to APS mode, raise throttle stick slowly until heli lifts off.

可以使用APS LITE 半自動起飛嗎？

可以的，等待GPS狀態燈變成綠燈恆亮時，在Normal狀態下將油門搖桿放至最低點並切入APS 飛行模式，將油門搖桿緩緩的往上推直到直昇機起飛。

Q&A 4 **Can I perform semi-autonomous landing using APS LITE ?**
Yes, but must land in Normal mode. If landing with idle-up mode, you must switch back to normal mode to cut power immediately after landing, or switch back to 3GX Flight mode.

可以使用APS LITE 半自動降落嗎？

可以的，但是必須要用Normal降落，若用Idle降落，當直昇機落地後要立即切回Normal停止動力，或者是切回3GX飛行模式。

Q&A 5 **Why can't it pass the vibration test?**
APS LITE system is very sensitive to vibrations on the heli. Therefore, please check your helicopter carefully for wear or damages that might cause excessive vibration to the APS LITE . In addition, please slowly lift the heli to 50~100cm, and maintain leveled hover.

為什麼震動測試一直不能通過？

APS LITE 系統對直昇機的震動很敏感，所以請仔細檢查機況，看看是不是有哪裡的零件損壞而造成 APS LITE 的震動過大。另外，做震動測試時，請緩緩的起飛50公分到1公尺停懸，直昇機請盡量保持水平狀態。

Q&A 6 **Why does the rudder twitches once when switched to APS flight mode?**
If vibration test has not been passed, or SET button wasn't pressed to record the passing event, the LINK LED on APS LITE will light red when the power of gyro is on, and APS function disabled. Should you try to switch 3GX flight mode into APS flight mode, the helicopter will wag its tail left/ right once, and remain in 3GX mode without going into APS flight mode.

為什麼進入APS飛行模式時，直昇機的尾舵會晃一下？

如果沒通過震動測試或通過測試沒按SET鍵記憶，當APS LITE 陀螺儀電源開啓時，APS LITE 面板上的LINK燈會亮紅燈，並且會關閉APS功能，此時當您從3GX飛行模式切到APS 飛行模式，直昇機會先左右擺動尾巴一次，然後維持原本3GX的飛行模式，不會進入APS 飛行模式，以確保安全。

Q&A 7

Why does the heli oscillates in a circular pattern and unable to fix on a point when in APS flight mode?

Possible incorrect offset value of the magnetometer causing APS to receive incorrect information. Please perform the magnetometer calibration again, and reattempt the position hold. This could also be due to insufficient attitude gain, which can be alleviated by increasing the attitude gain. See page 35.

為什麼在APS飛行模式時，直昇機會繞圈沒有辦法定位在同一點？

有可能因磁力計的校正值不正確，而造成APS模組使用到錯誤的資訊，進而沒有辦法定位在同一點，請重新校正磁力計，然後再重新定位一次。也有可能是直昇機的姿態感度不夠，請稍微調大姿態感度，然後再檢查定位情況是否有改善，請參考第35頁姿態感度和水平位置感度調整。

Q&A 8

Why is the helicopter drifting off from a straight line when it's commanded to fly straight?

Due to the declination between true north and magnetic north, and APS sensor uses magnetic north, calibration is needed to achieve true heading of the magnetometer. If helicopter drifts to the right, reinstall the APS module so it rotates a certain degree counter-clockwise. Actual degree will depend on the level of drift during test flight. Normally 5 degrees deviation is the standard. If helicopter drifts to the left, rotate the GPS module clockwise.

為什麼單獨下指令希望直昇機筆直往前飛，而直昇機卻偏一邊？

因為地球地理北極和地磁北極相差一個角度，APS感應器是控制直昇機往地磁北極飛，所以需要使用者做頭向修正，若直昇機偏右時，則把APS感應器逆時鐘旋轉一個角度，旋轉的角度依照直昇機偏斜的角度而定，偏的角度越大，旋轉的角度越大，正常情況大約在5度左右；若直昇機偏左，則順時鐘旋轉。將地磁北極旋轉和地理北極重合，校正之後直昇機就可以筆直飛行了。

Q&A 9

Can the APS LITE module and GPS module be installed inverted?

No. Incorrect installation position will result in incorrect data, please install in the proper direction shown in the page 10-13.

APS LITE模組和GPS模組可以倒著安裝嗎？

不行，安裝方向錯誤會造成錯誤的資訊，請按照說明書第10至13頁的安裝方向安裝。

Q&A 10

What happens when RC system loses signal?

If the RC controller has failsafe, and APS LITE is setup properly per instruction, helicopter will automatically return home once signal is lost. For more information about Failsafe Protection, See page.28 & page. 46

若遙控器失去訊號了會怎麼樣？

若遙控器有失控保護功能，按照APS LITE 說明書設定之後，一旦遙控器失去訊號，直昇機會自動返航至Home點。關於失控保護相關資訊，請參考第28頁失控保護設定及第46頁失控保護注意事項。

Q&A 11

After switching to APS flight mode, helicopter moves up and down without ability to stabilize altitude.

Check for any abnormal vibration source within the helicopter frame, or try mounting the APS control module with the included metal plate per the instruction for mounting on glow helicopter. See page 11. Lower the headspeed within APS Flight mode to improve vertical altitude vibration. It also can be due to insufficient Vertical Position altitude gain, which can be alleviated by increasing the attitude gain. See page 35.

進入APS飛行模式時，直昇機高度忽高忽低無法穩定高度？

請檢查直昇機機體是否有異常震動源，或者APS控制器可使用附加的鐵片，依照說明書引擎直昇機的安裝方式第11頁進行安裝，可改善這種不穩定現象。將APS飛行模式轉速降低，可改善高度不穩定現象。也有可能是直昇機的垂直位置感度不足，請調高垂直位置感度來改善高度不穩定現象(請參考第35頁垂直位置感度調整)

www.align.com
www.
www.align.com
www.alig
www.align
www.align.com.tw
www.align.com.

ALIGN